



US00D952166S

(12) **United States Design Patent**
Peluso et al.

(10) **Patent No.:** **US D952,166 S**
(45) **Date of Patent:** **** May 17, 2022**

(54) **FACIAL MASSAGER**

(71) Applicant: **Fourstar Group Inc.**, Taipei (TW)

(72) Inventors: **Jason M. Peluso**, Largo, FL (US);
Sofia Banda, Pinellas Park, FL (US)

(73) Assignee: **Fourstar Group Inc.**, Taipei (TW)

(**) Term: **15 Years**

(21) Appl. No.: **29/761,247**

(22) Filed: **Dec. 8, 2020**

(51) **LOC (13) Cl.** **28-03**

(52) **U.S. Cl.**

USPC **D24/200**

(58) **Field of Classification Search**

USPC D24/200, 108, 112–122, 127, 133,
D24/146–149, 151, 172–176, 214–215,
D24/231, 211; D28/56, 57, 28, 59, 62,
D28/44, 7, 9; D8/107, 14, 98–100, 300,
D8/20, 17, 47; D7/669, 682, 697;
D4/100, 102, 121, 127, 130, 132–136,
D4/138, 199
CPC A61M 5/3287; A61M 5/3289; A61M
5/3295–3298; A61M 37/0015; A61M
2037/0061; A61H 7/003; A61H 15/0092;
A61H 2015/0014; A46B 9/02; A46B
13/02; A46B 2200/1006; A46B 2200/102;
A61B 2017/00747; A61B 2017/00761;
A61B

(Continued)

(56) **References Cited**

U.S. PATENT DOCUMENTS

D207,080 S * 2/1967 McNair D24/214
D331,467 S * 12/1992 Wollman D24/214
D361,404 S * 8/1995 Haas D28/7

(Continued)

OTHER PUBLICATIONS

Lifetrons Essential Oil Booster Micro-Vibration Massager, first available Dec. 5, 2015, amazon.com, [online], [site visited Jan. 26,

2022], Available from internet URL: https://www.amazon.com/gp/product/B0151MF970/ref=as_li_tl?ie=UTF8&camp=1789&creative= (Year: 2015).*

(Continued)

Primary Examiner — Samantha Q Lawrence

Assistant Examiner — Holly M Rodriguez

(74) *Attorney, Agent, or Firm* — Salter & Michaelson

(57) **CLAIM**

The ornamental design for a facial massager, as shown and described.

DESCRIPTION

FIG. 1 is a perspective view of a facial massager; FIG. 2 is a front elevational view thereof; FIG. 3 is a rear elevational view thereof; FIG. 4 is a right side elevational view thereof; FIG. 5 is a left side elevational view thereof; FIG. 6 is a top plan view thereof; FIG. 7 is a bottom plan view thereof; FIG. 8 is a perspective view of a second embodiment thereof; FIG. 9 is a front elevational view of a second embodiment thereof; FIG. 10 is a rear elevational view of a second embodiment thereof; FIG. 11 is a right side elevational view of a second embodiment thereof; FIG. 12 is a left side elevational view of a second embodiment thereof; FIG. 13 is a top plan view of a second embodiment thereof; and, FIG. 14 is a bottom plan view of a second embodiment thereof.

The broken lines shown in FIGS. 7-9, 11-12, and 14 illustrate portions of the facial massager that form no part of the claimed design.

1 Claim, 12 Drawing Sheets

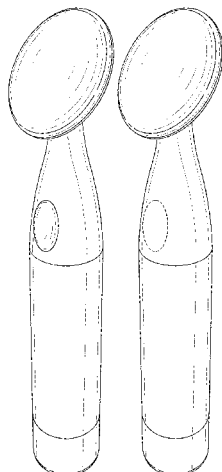

(58) **Field of Classification Search**

CPC 17/062; A61B 17/3205; A61B 17/32053;
A61N 2005/0644; A61N 2007/0034

See application file for complete search history.

(56) **References Cited**

U.S. PATENT DOCUMENTS

D461,246 S * 8/2002 Park D28/59
 D659,843 S * 5/2012 Wang D24/200
 D678,783 S * 3/2013 Wilcox D28/7
 10,154,857 B1 * 12/2018 Dunmire A61B 17/54
 D888,264 S * 6/2020 Sherrill D24/215
 D933,840 S * 10/2021 Hermann D24/200
 2003/0165550 A1 * 9/2003 Rhoades A45D 34/042
 424/401
 2016/0235622 A1 * 8/2016 Fan A61H 23/0263

OTHER PUBLICATIONS

Anti Aging Face Massager by VIJUVE, first available Oct. 23, 2017, amazon.com, [online], [site visited Jan. 26, 2022], Available from internet URL: https://www.amazon.com/gp/product/B0747YZVN6/ref=as_li_tl?ie=UTF8&camp=1789&creative=390957&creativeASIN=B0747YZVN6&linkCode=as2%E2%80%A6 (Year: 2017).*

* cited by examiner

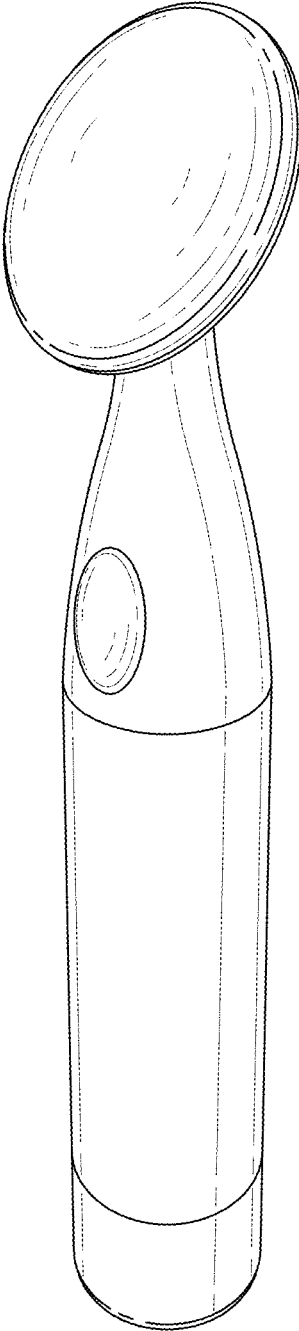

FIG. 1

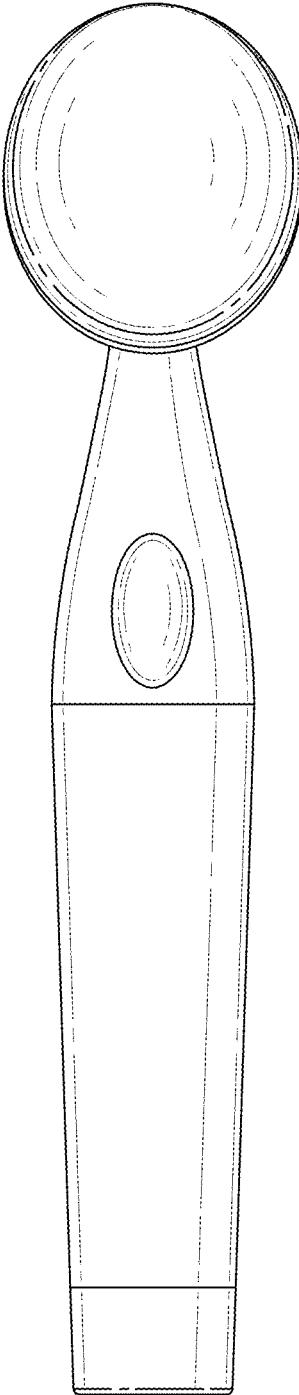

FIG. 2

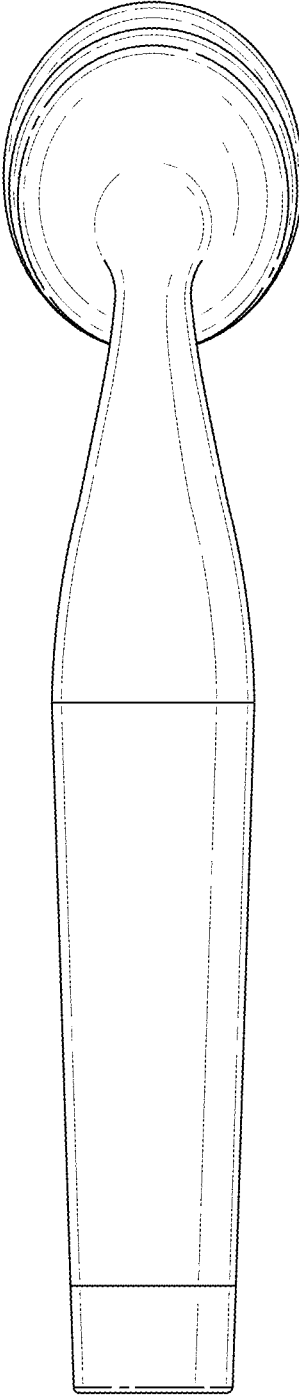

FIG. 3

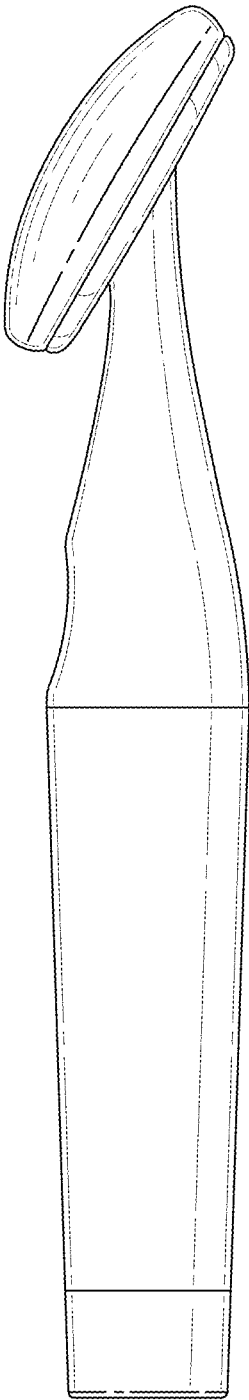

FIG. 4

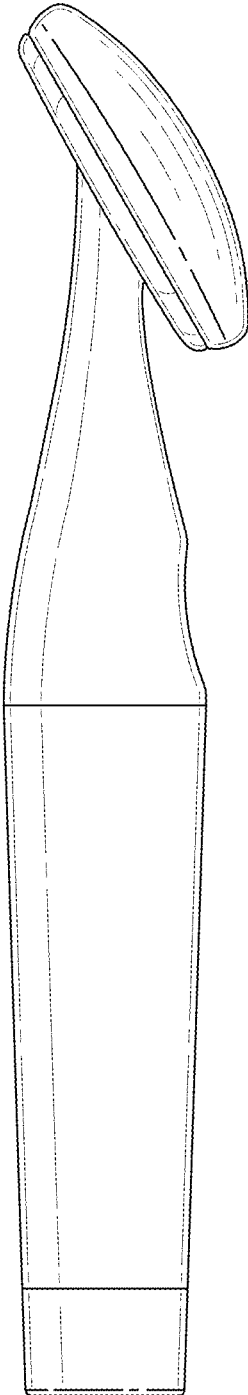

FIG. 5

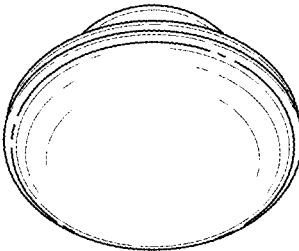

FIG. 6

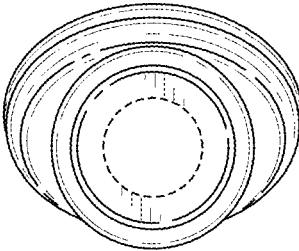

FIG. 7

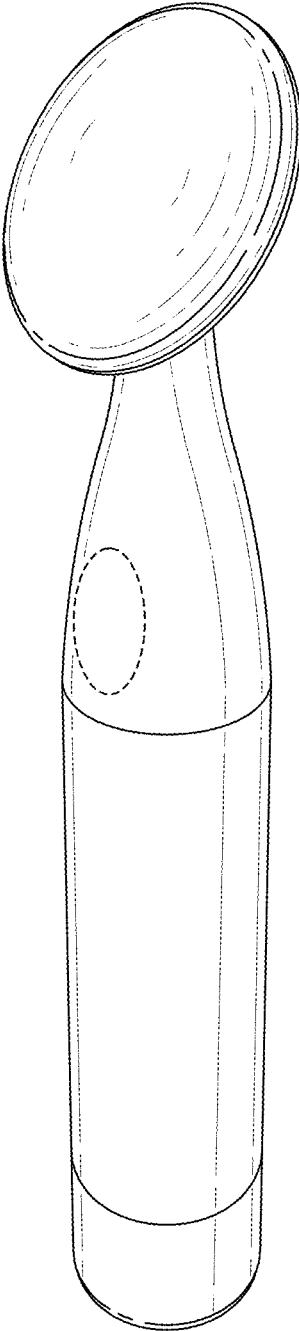

FIG. 8

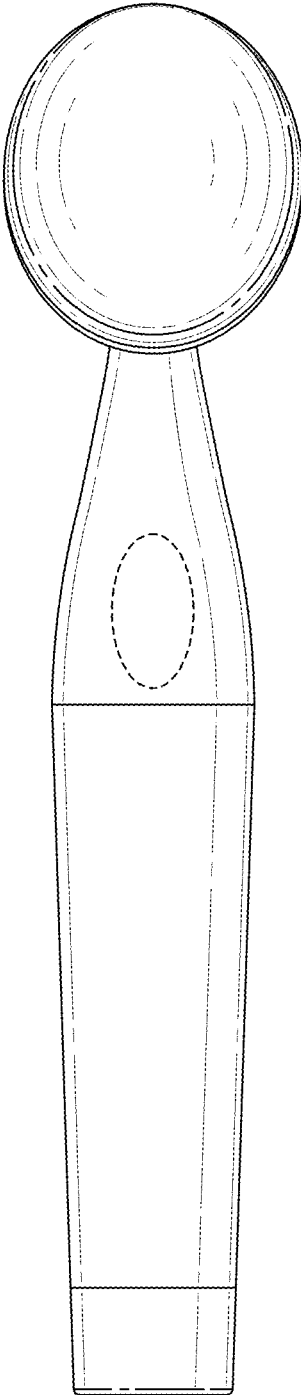

FIG. 9

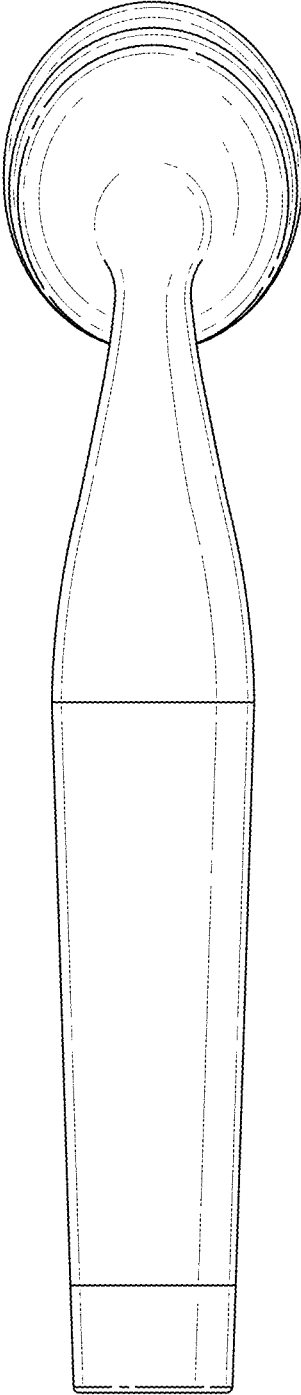

FIG. 10

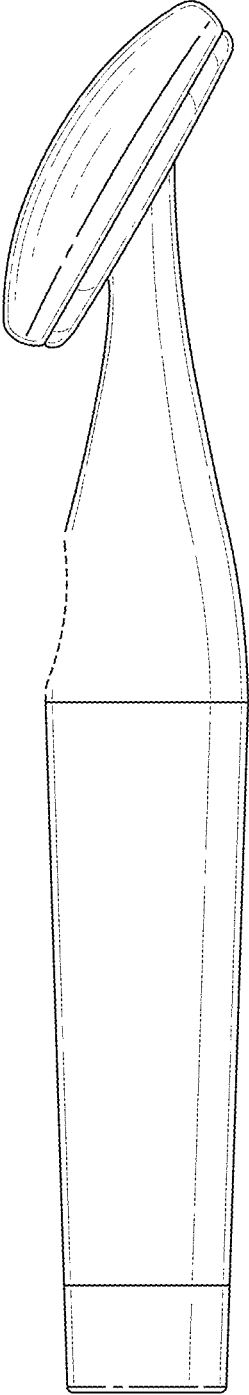

FIG. 11

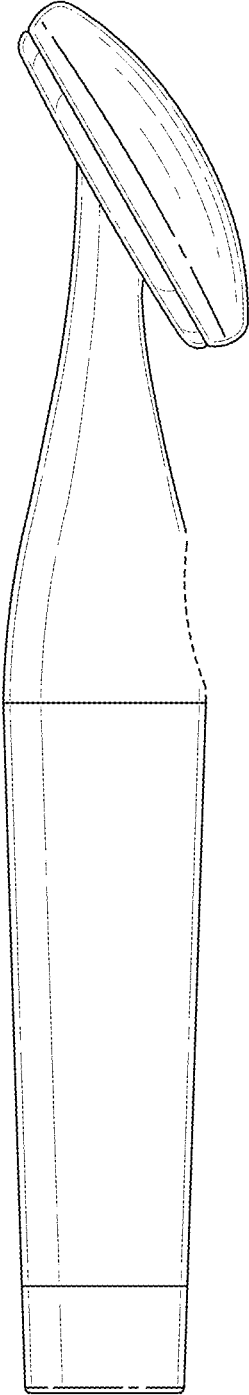

FIG. 12

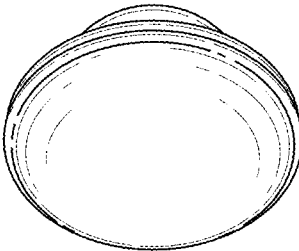

FIG. 13

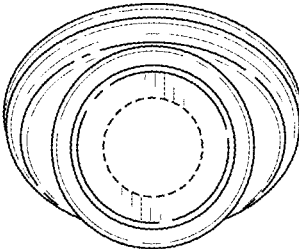

FIG. 14