



US00D656967S

(12) **United States Design Patent**
Yi et al.

(10) **Patent No.:** **US D656,967 S**

(45) **Date of Patent:** **** Apr. 3, 2012**

(54) **REFRIGERATOR**

(75) Inventors: **Jaesoon Yi**, Seoul (KR); **Jihyun Lee**,
Seoul (KR); **Jidam Hong**, Seoul (KR)

(73) Assignee: **Samsung Electronics Co., Ltd.**,
Suwon-si (KR)

(**) Term: **14 Years**

(21) Appl. No.: **29/390,101**

(22) Filed: **Apr. 20, 2011**

(51) **LOC (9) Cl.** **15-07**

(52) **U.S. Cl.** **D15/86**

(58) **Field of Classification Search** D15/79,
D15/81, 85-88, 91; 62/3.6, 246-255, 293,
62/331, 371, 440, 467, 529, 531, 337; 312/400-409,
312/352, 116

See application file for complete search history.

(56) **References Cited**

U.S. PATENT DOCUMENTS

D553,652 S * 10/2007 Park et al. D15/86
D578,559 S * 10/2008 Lee et al. D15/85

D579,031 S * 10/2008 Lee et al. D15/85
D587,729 S * 3/2009 Choi et al. D15/85
D595,315 S * 6/2009 Lee et al. D15/85
D601,595 S * 10/2009 Yoon et al. D15/85
D601,596 S * 10/2009 Yoon et al. D15/85
D603,429 S * 11/2009 Lee et al. D15/85
D615,999 S * 5/2010 Yamaguchi et al. D15/85
D629,022 S * 12/2010 Cho et al. D15/85

* cited by examiner

Primary Examiner — Mitchell Siegel

(74) *Attorney, Agent, or Firm* — Ladas & Parry LLP

(57) **CLAIM**

We claim the ornamental design for a refrigerator, as shown.

DESCRIPTION

FIG. 1 is a front/right-side/top perspective view of a refrigerator showing our new design;
FIG. 2 is a front-side elevational view thereof;
FIG. 3 is a rear-side elevational view thereof;
FIG. 4 is a left-side elevational view thereof;
FIG. 5 is a right-side elevational view thereof;
FIG. 6 is a top-side elevational view thereof; and,
FIG. 7 is a bottom-side elevational view thereof.

1 Claim, 6 Drawing Sheets

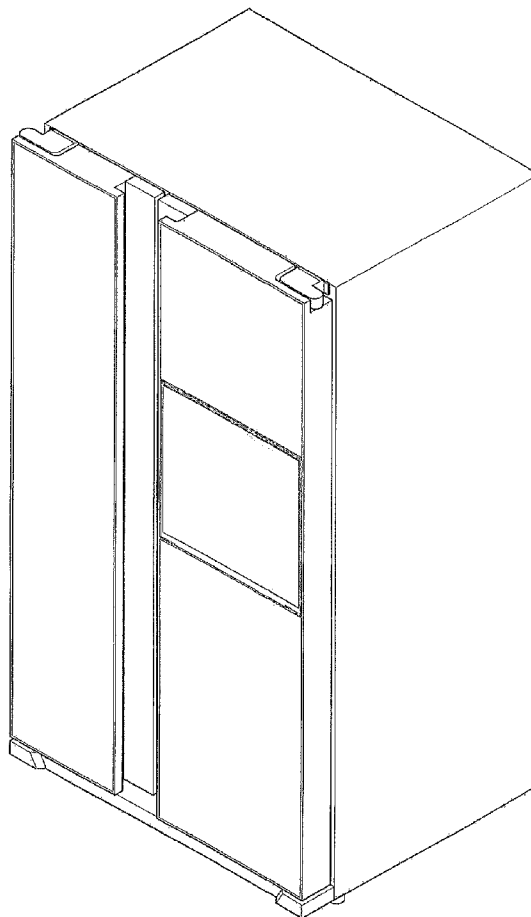

FIG. 1

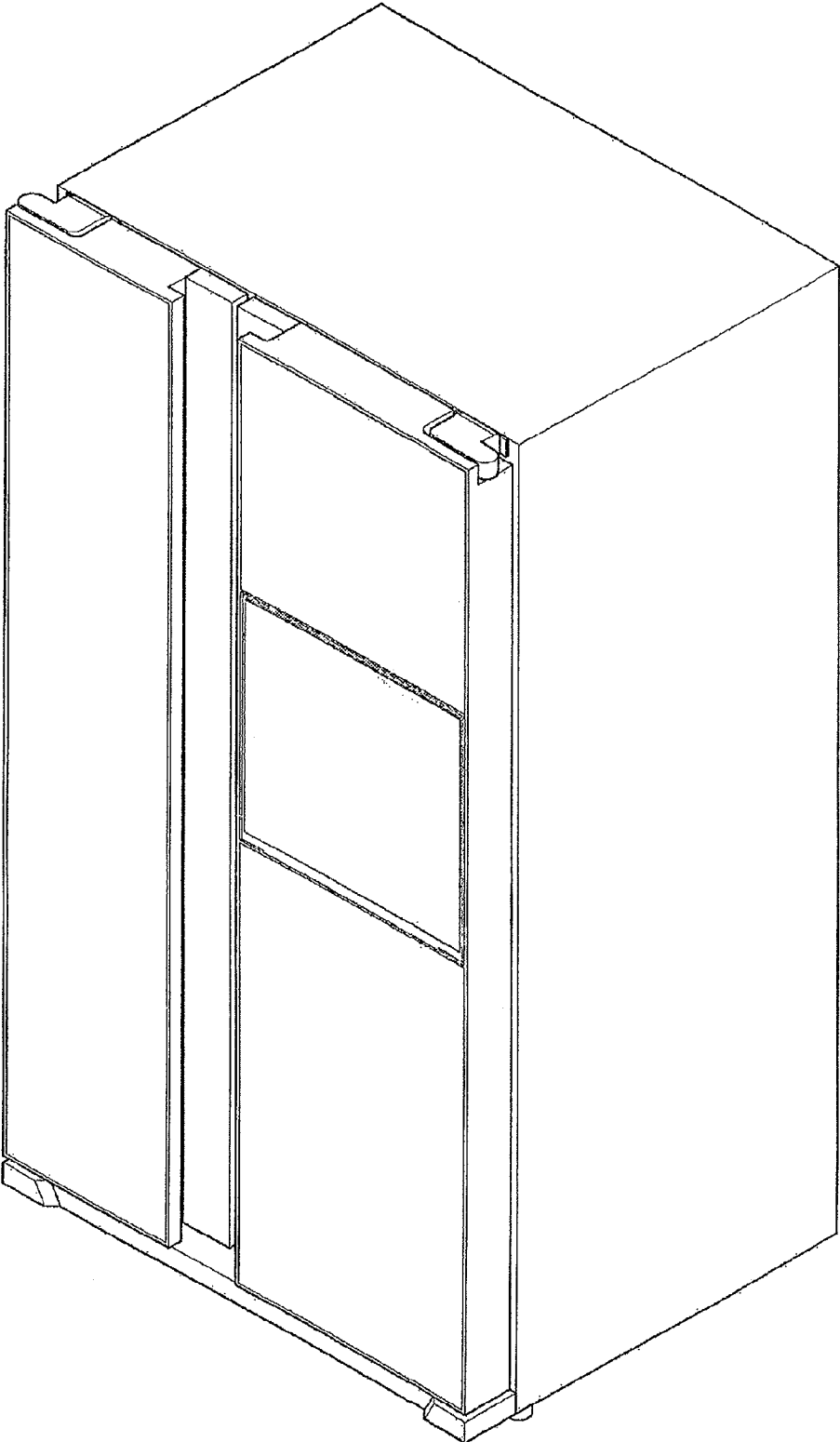

FIG. 2

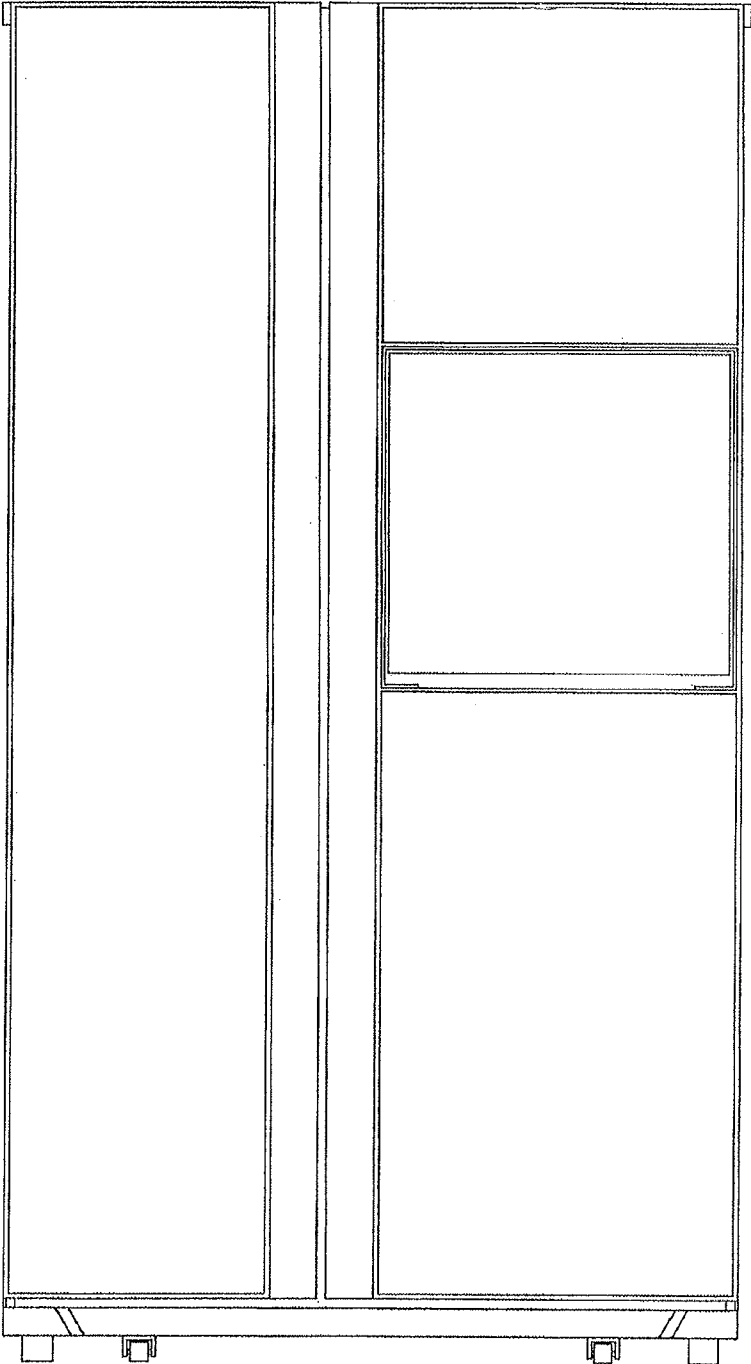

FIG. 3

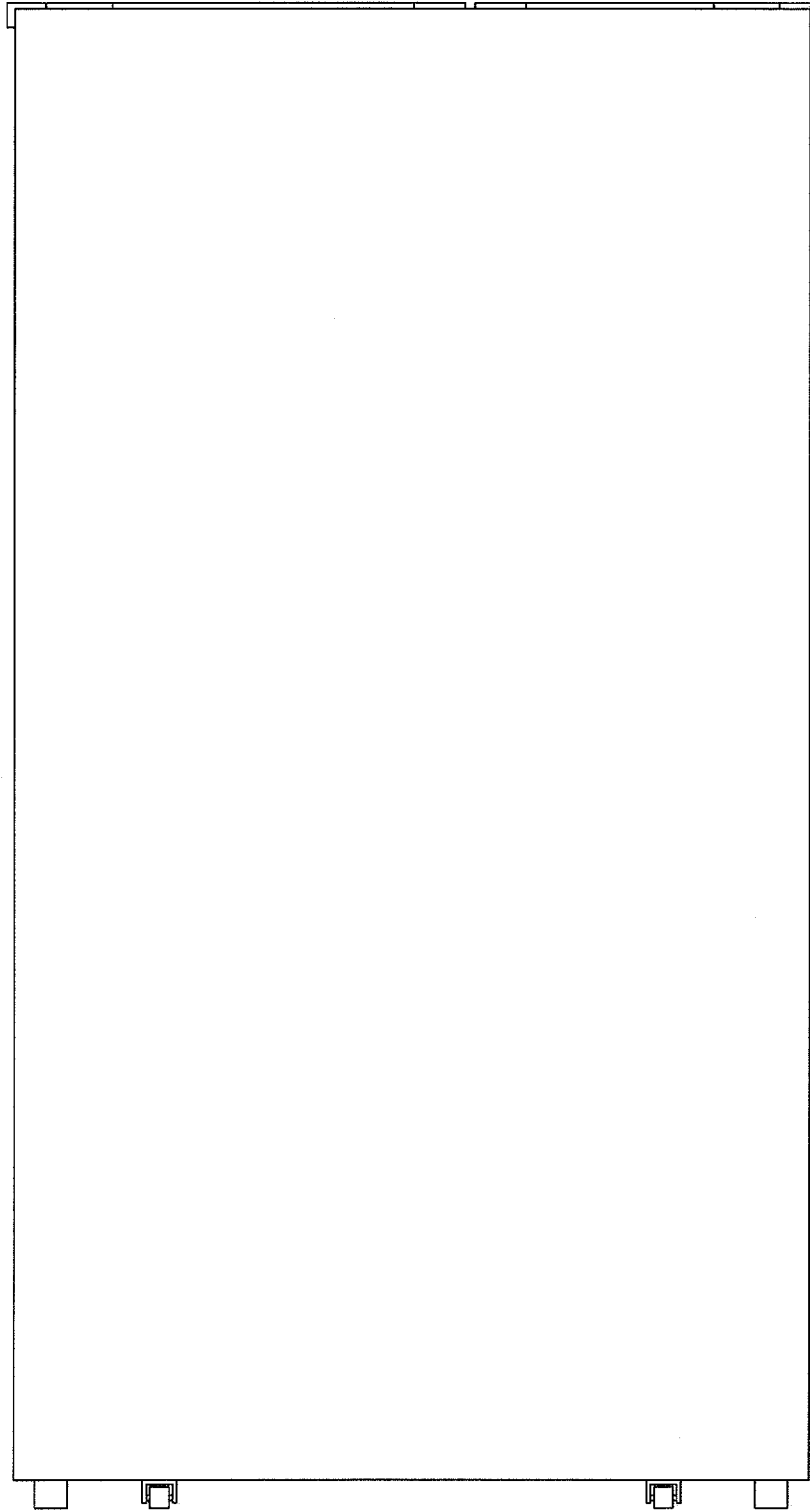

FIG. 4

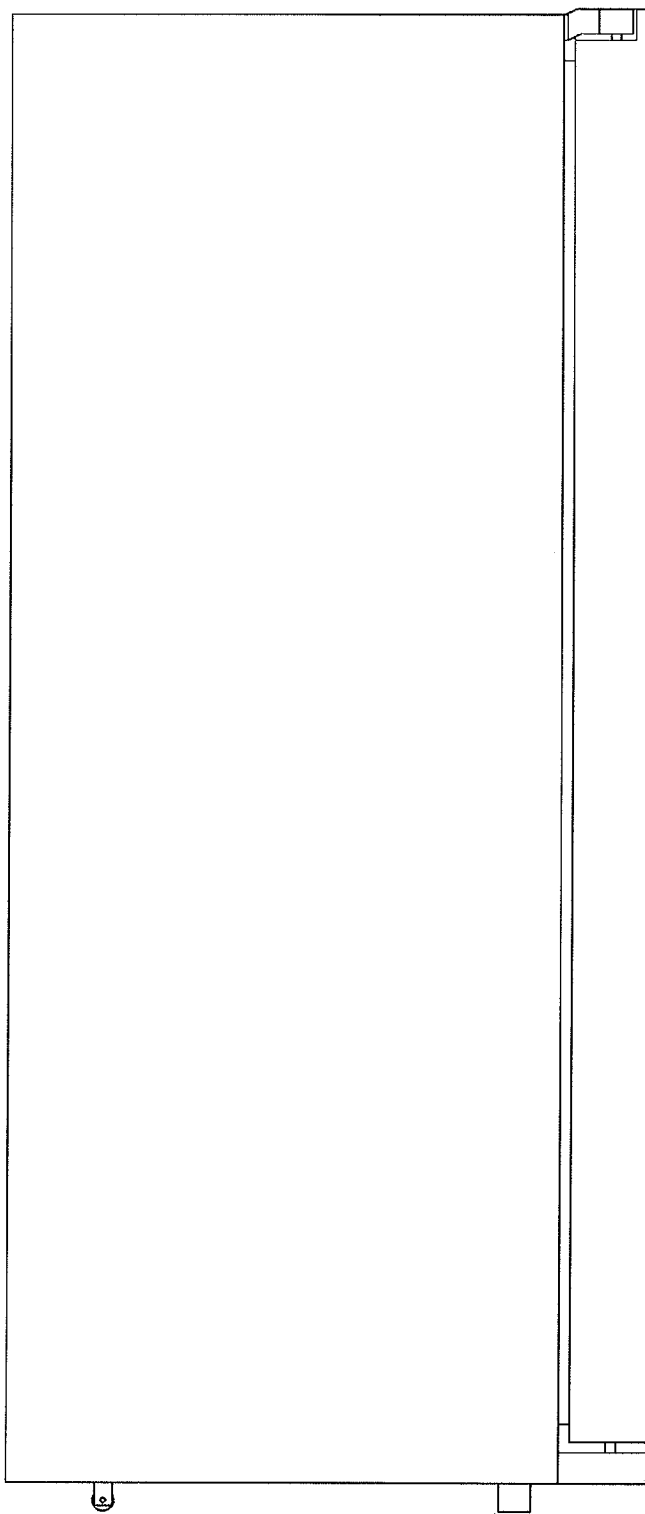

FIG. 5

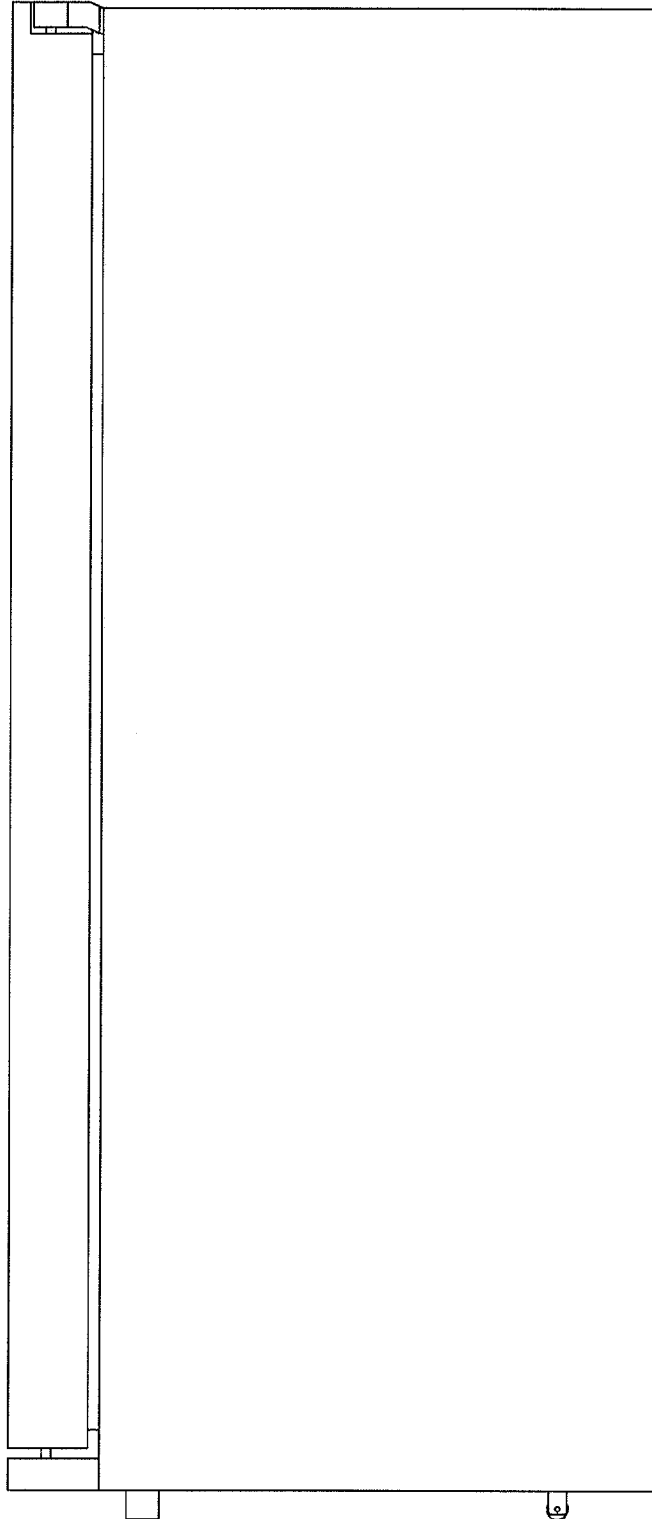

FIG. 6

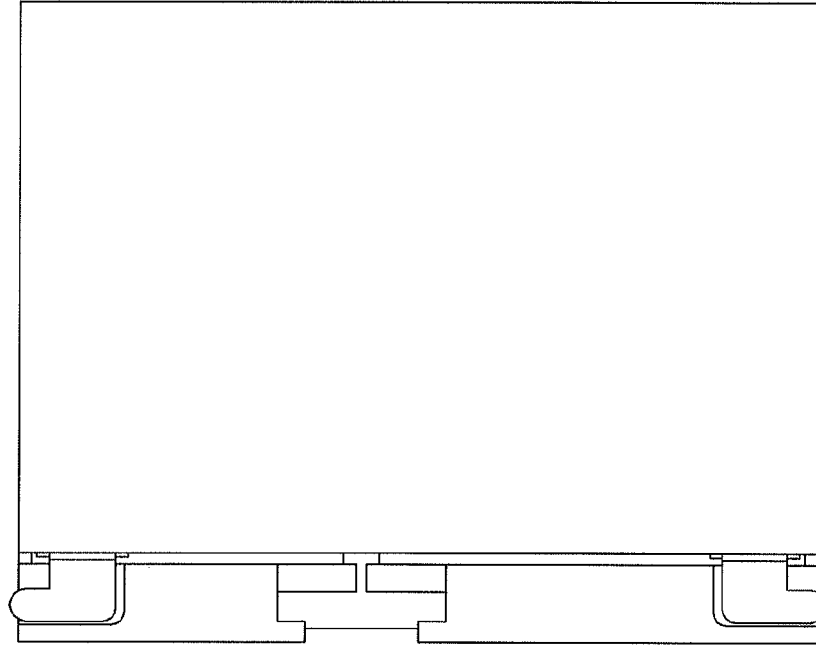

FIG. 7

