



US00D561294S

(12) **United States Design Patent**
Pennington

(10) **Patent No.:** **US D561,294 S**

(45) **Date of Patent:** **** Feb. 5, 2008**

(54) **STUN GUN**

D503,451 S * 3/2005 Tal D22/117
D530,777 S * 10/2006 Rhee D22/117

(76) Inventor: **Billy Pennington**, 414 S. Pulaski St.,
Suite 1, Little Rock, AR (US) 72201

* cited by examiner

(**) Term: **14 Years**

Primary Examiner—Catherine R. Oliver
(74) *Attorney, Agent, or Firm*—Crossley Patent Law; Mark
A. Crossley

(21) Appl. No.: **29/247,836**

(22) Filed: **Jul. 14, 2006**

(57) **CLAIM**

(51) **LOC (8) Cl.** **22-02**

The ornamental design for a stun gun, as shown and
described.

(52) **U.S. Cl.** **D22/117**

(58) **Field of Classification Search** D22/117,
D22/118, 199, 105; 42/1.08; 222/175, 183
See application file for complete search history.

DESCRIPTION

(56) **References Cited**

FIG. 1 is a front elevation view of a stun gun showing my
new design;
FIG. 2 is a top plan view;
FIG. 3 is a bottom plan view;
FIG. 4 is a right side elevation view;
FIG. 5 is a left side elevation view; and,
FIG. 6 is a left side isometric view of a stun gun showing my
new design.

U.S. PATENT DOCUMENTS

D351,639 S	10/1994	Su	D22/117
D365,622 S	* 12/1995	Edwards	D22/117
D375,994 S	* 11/1996	Collins et al.	D22/117
6,256,916 B1	7/2001	McNulty	42/1.08
D469,498 S	* 1/2003	Oscarsson	D22/117
6,636,412 B2	10/2003	Smith	361/232
6,807,762 B1	10/2004	Edwards	42/1.08

1 Claim, 4 Drawing Sheets

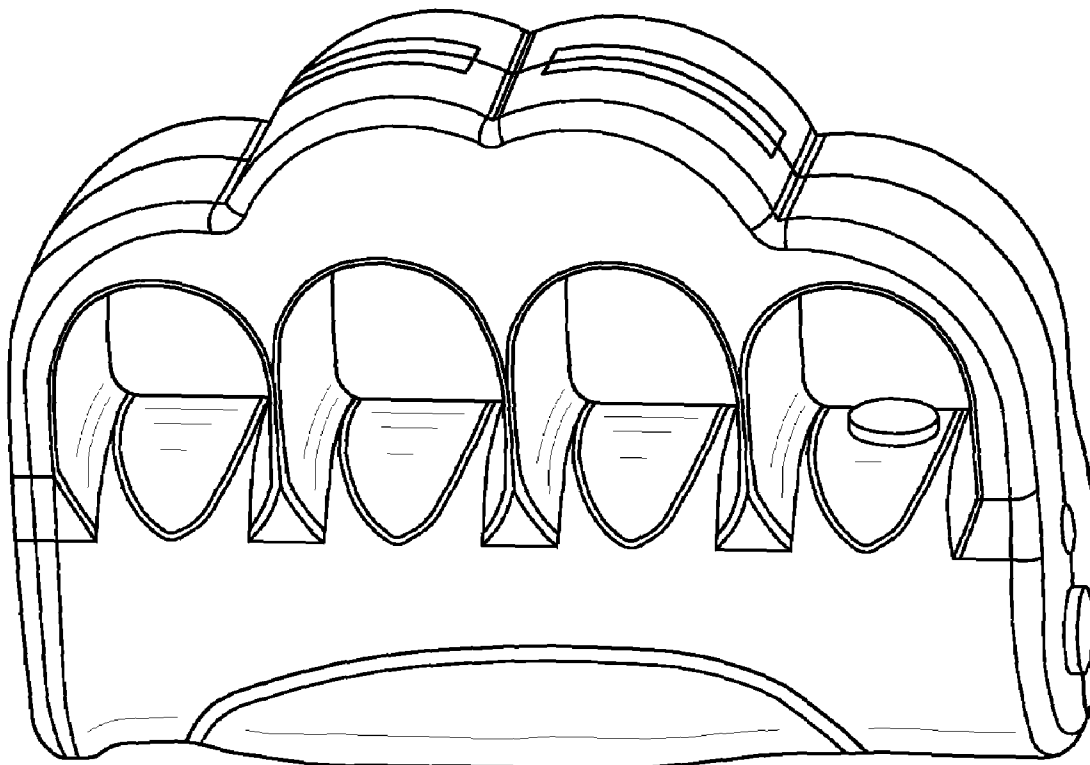

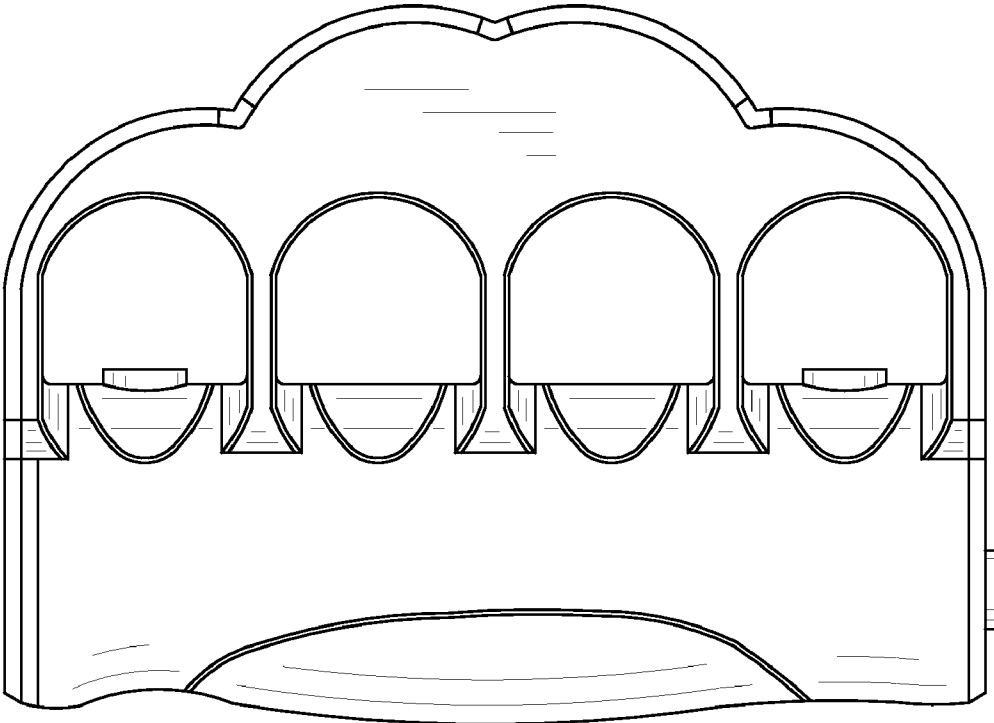

FIG. 1

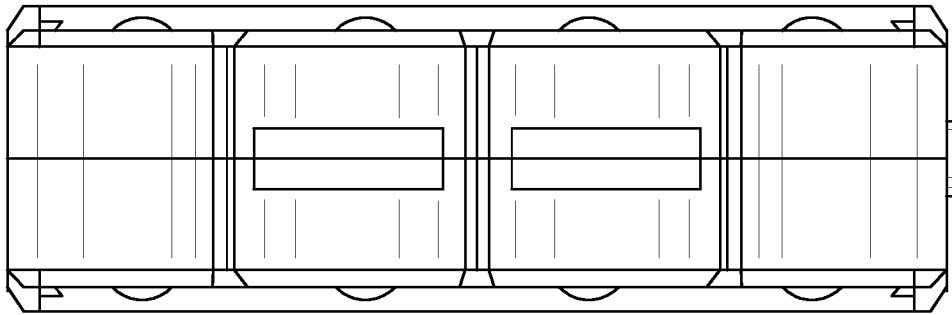

FIG. 2

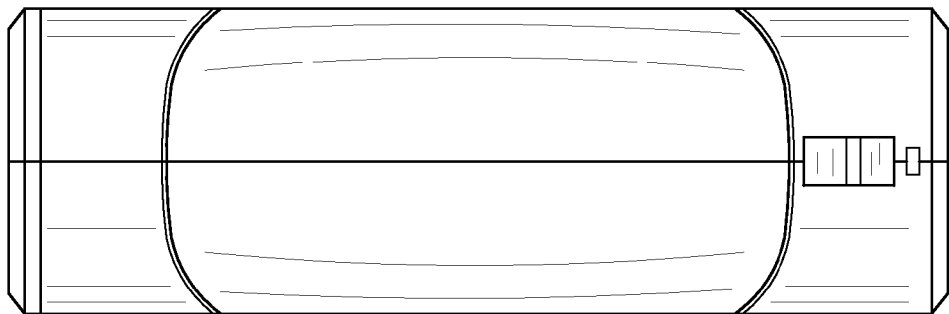

FIG. 3

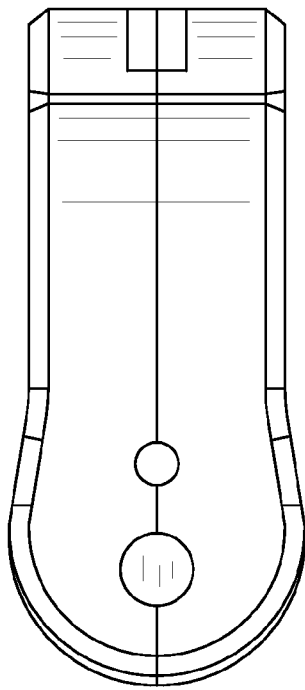

FIG. 4

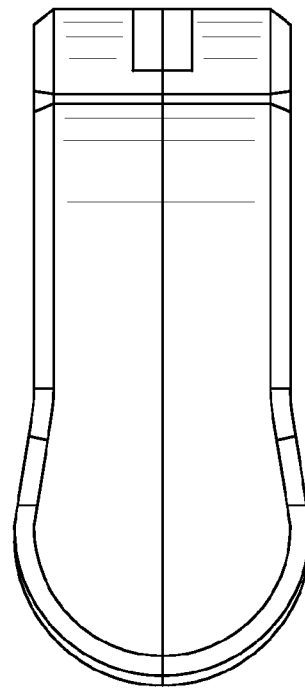

FIG. 5

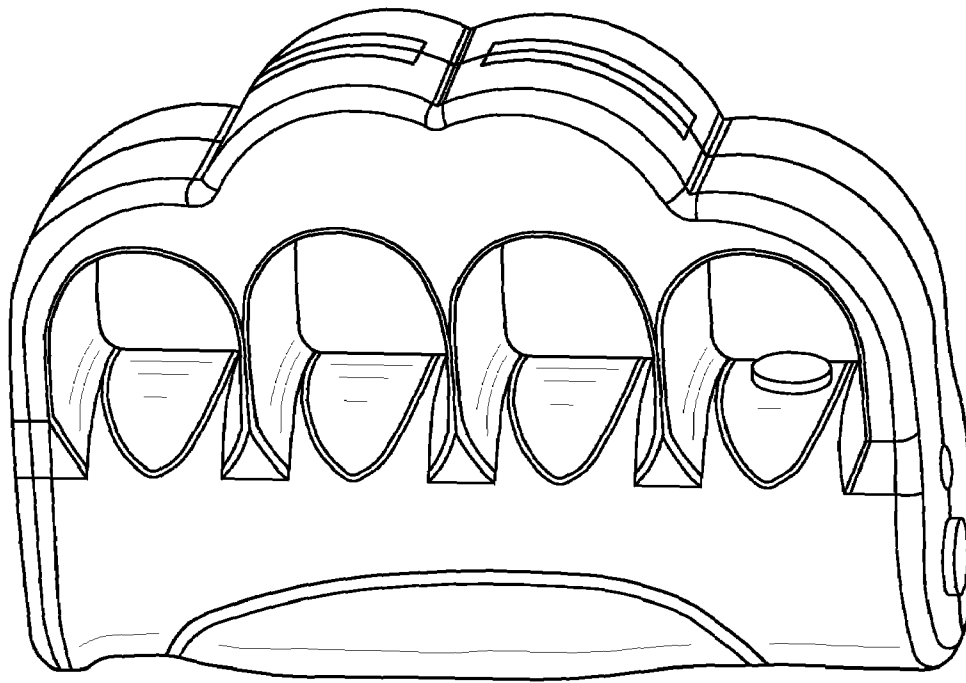

FIG. 6