



US00D874217S

(12) **United States Design Patent** (10) **Patent No.:** **US D874,217 S**  
**Tsai** (45) **Date of Patent:** **\*\* Feb. 4, 2020**

(54) **BEVERAGE CONTAINER**  
(71) Applicant: **Igloo Products Corp.**, Katy, TX (US)  
(72) Inventor: **Vincent Tsai**, Quincy, MA (US)  
(73) Assignee: **Igloo Products Corp.**, Katy, TX (US)  
(\*\*) Term: **15 Years**  
(21) Appl. No.: **29/624,829**  
(22) Filed: **Nov. 3, 2017**  
(51) **LOC (12) Cl.** ..... **07-01**  
(52) **U.S. Cl.**  
USPC ..... **D7/396.2; D7/608**  
(58) **Field of Classification Search**  
USPC ..... D7/603-608, 509-511, 398, 396.2, 392,  
D7/392.1; D9/500-504, 443, 516, 532,  
D9/522, 558, 549, 559, 574, 575, 434,  
D9/435, 446, 447  
CPC .. A45C 11/20; F25D 3/08; F25D 3/14; A47G  
19/2205; A47G 2019/2294; A47G 19/23;  
A47G 19/2272; A47G 19/22; A47G  
19/2294; A47J 41/02; A47J 41/022; A47J  
41/024; A47J 41/026; A47J 41/028; A47J  
41/00; A47J 41/0077; A47J 43/27; B65D  
81/3823; B65D 81/3818; B65D 81/3846;  
B65D 81/2886; B65D 81/3879; B65D  
47/08; B65D 23/00; B65D 47/066; B65D  
41/04; B65D 41/0414; A45F 3/16  
See application file for complete search history.

(56) **References Cited**  
**U.S. PATENT DOCUMENTS**  
D295,355 S \* 4/1988 Leung ..... D7/608  
6,119,888 A \* 9/2000 Goto ..... A47J 41/0083  
215/13.1

6,170,693 B1 \* 1/2001 Goto ..... A47J 41/0011  
220/256.1  
D488,675 S \* 4/2004 Moore ..... D7/608  
D530,611 S \* 10/2006 Nusbaum ..... D9/449  
D572,981 S \* 7/2008 Carreno ..... D7/510  
D596,460 S \* 7/2009 Nezu ..... D7/510  
D619,418 S \* 7/2010 Nezu ..... D7/510  
RE42,484 E \* 6/2011 Kitamura ..... D7/510  
D675,060 S \* 1/2013 Lane ..... D7/392.1  
D739,183 S \* 9/2015 Lane ..... D7/605  
9,150,335 B2 \* 10/2015 Lane ..... A45F 3/16  
D744,781 S \* 12/2015 Rummel ..... D7/511  
D747,918 S \* 1/2016 Herbst ..... D7/392.1  
D748,949 S \* 2/2016 Long, Sr. .... D7/510  
9,675,191 B2 \* 6/2017 Kurabe ..... A47G 19/2272  
2001/0010313 A1 \* 8/2001 Goto ..... A47J 41/0083  
220/592.27  
2002/0036207 A1 \* 3/2002 Ohuo ..... A47G 19/2266  
220/830

\* cited by examiner

*Primary Examiner* — Terry A Wallace  
(74) *Attorney, Agent, or Firm* — Mintz Levin Cohn Ferris  
Glovsky and Popeo, P.C.; Steven M. Jensen

(57) **CLAIM**

The ornamental design for a beverage container, as shown and described.

**DESCRIPTION**

FIG. 1 is a perspective view of a beverage container showing my new design.  
FIG. 2 is a front view thereof.  
FIG. 3 is a rear view thereof.  
FIG. 4 is a left side view thereof.  
FIG. 5 is a right side view thereof.  
FIG. 6 is a top plan view thereof; and,  
FIG. 7 is a bottom plan view thereof.  
The broken lines are for illustrative purposes only and form no part of the claimed design.

**1 Claim, 6 Drawing Sheets**

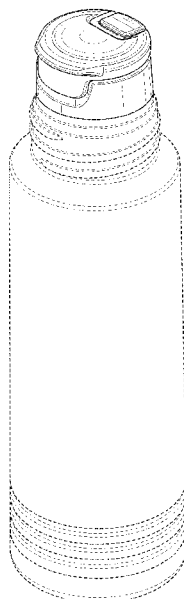

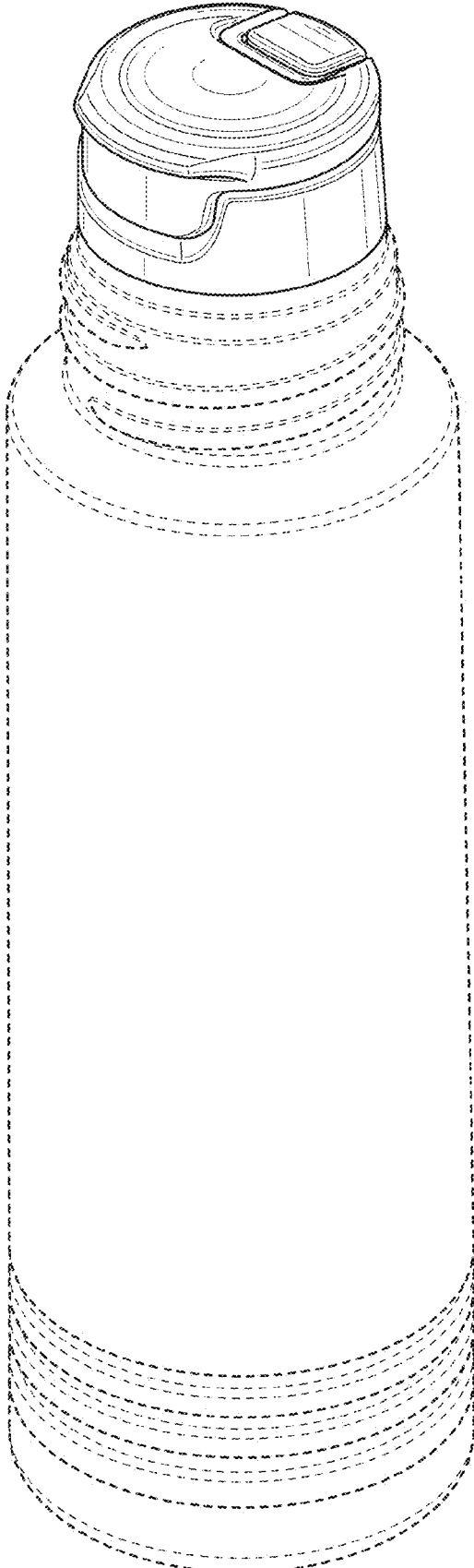

FIG. 1

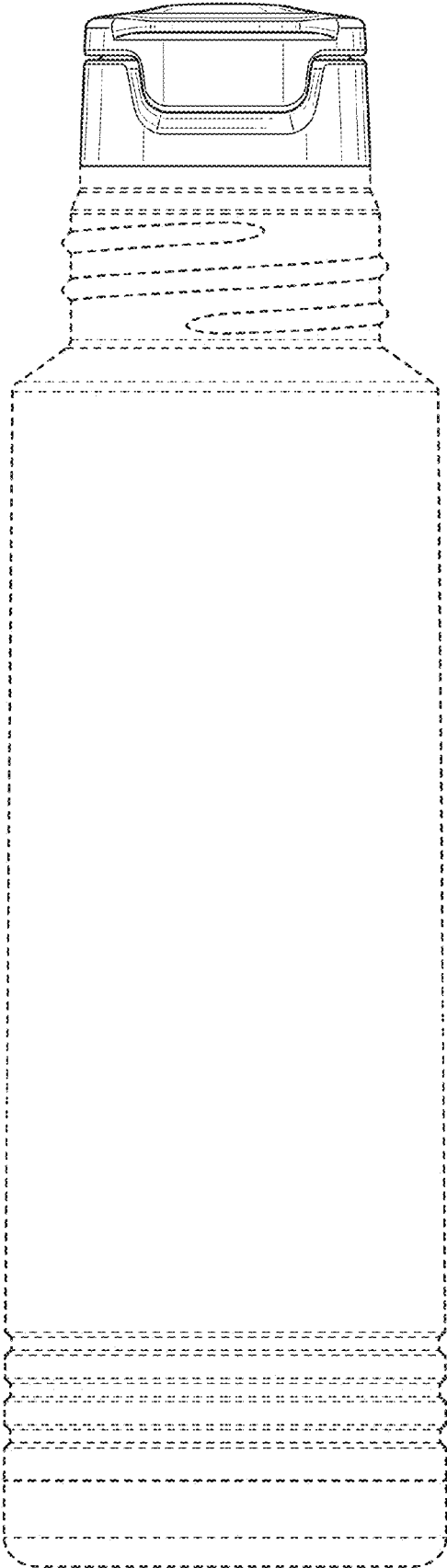

FIG. 2

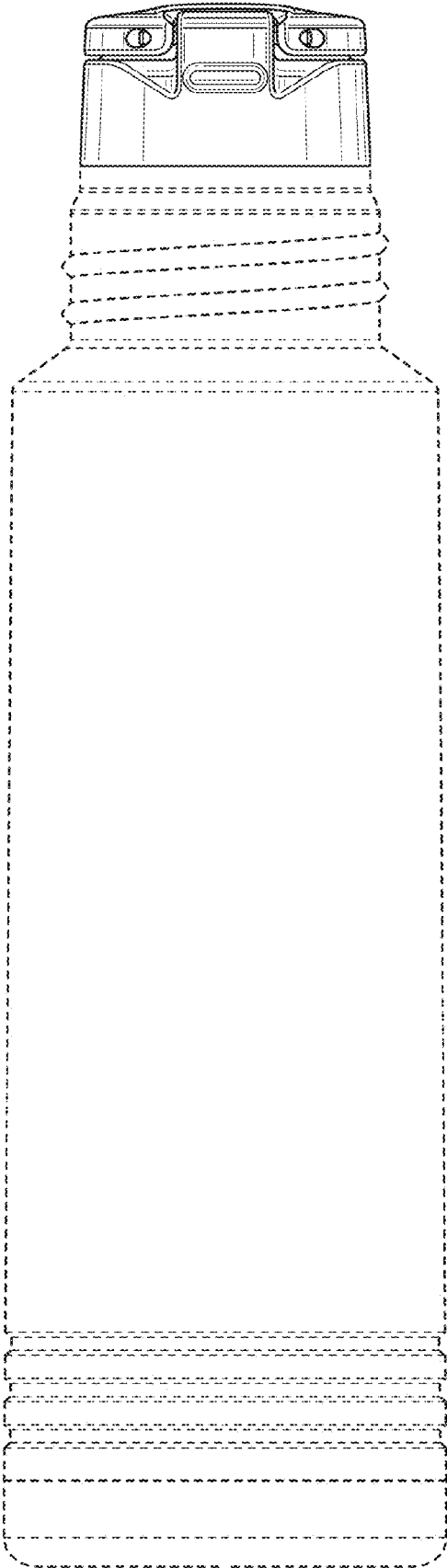

FIG. 3

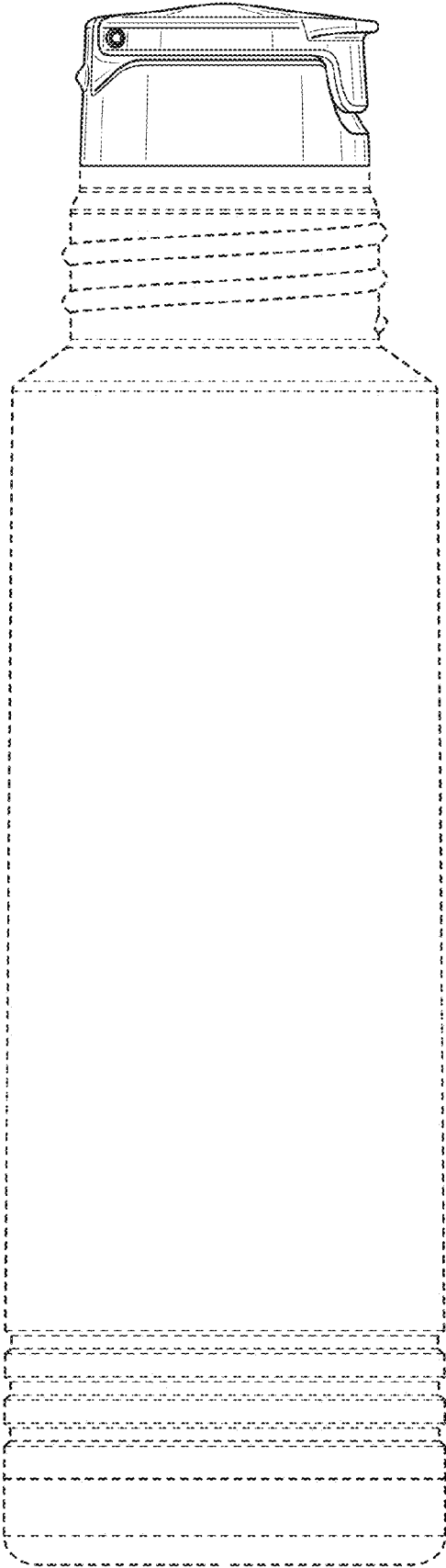

FIG. 4

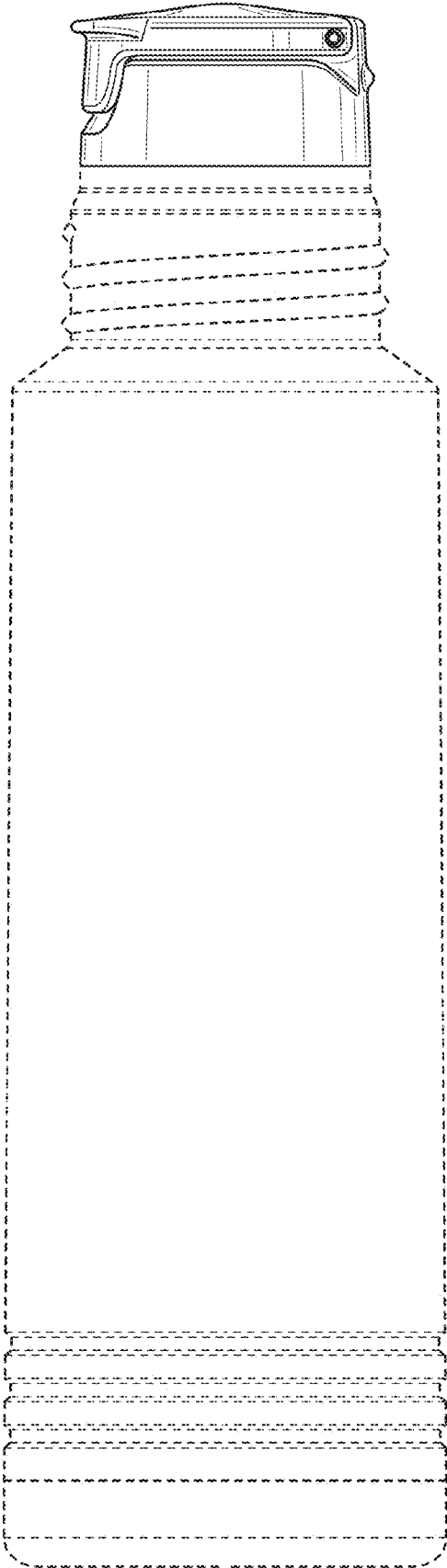

FIG. 5

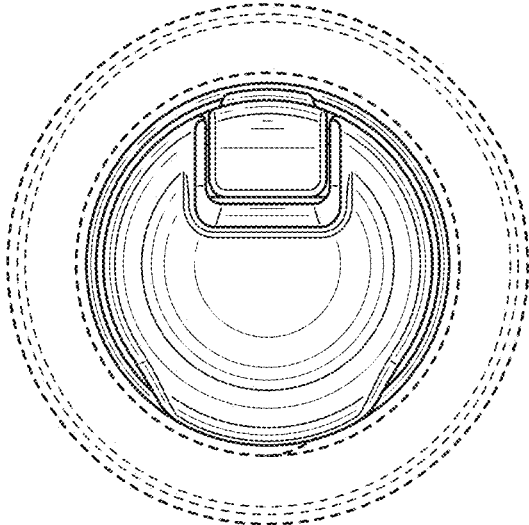

FIG. 6

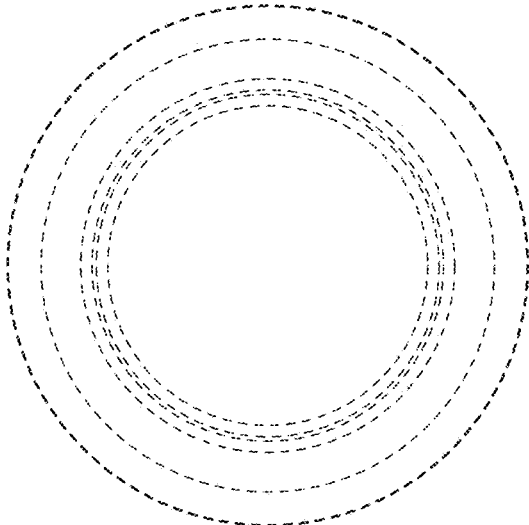

FIG. 7