



US00D845646S

(12) **United States Design Patent**  
**Nicoline**

(10) **Patent No.:** **US D845,646 S**

(45) **Date of Patent:** **\*\* Apr. 16, 2019**

(54) **MAKEUP BRUSH**

FOREIGN PATENT DOCUMENTS

(71) Applicant: **Paris Presents Incorporated**, Gurnee, IL (US)

CN 300826116 9/2008  
CN 301850467 3/2012

(Continued)

(72) Inventor: **Alyssa Carolyn Nicoline**, McHenry, IL (US)

OTHER PUBLICATIONS

(73) Assignee: **Paris Presents Incorporated**, Gurnee, IL (US)

Maria Pia, "Tom Ford Cream Foundation Brush review, photos and comparisons.," If Makeup Could Talk, LLC, Sep. 20, 2013, 4 pages. [URL] <http://ifmakeupcouldtalk.com/toolsaccessories/tom-ford-cream-foundation-brush-review-photos-and-comparisons/>.

(Continued)

(\*\*) Term: **15 Years**

(21) Appl. No.: **29/655,340**

*Primary Examiner* — Wan Laymon

*Assistant Examiner* — Clint A Samuel

(22) Filed: **Jul. 2, 2018**

(74) *Attorney, Agent, or Firm* — Quarles & Brady LLP

(57) **CLAIM**

The ornamental design for a makeup brush, as shown and described.

**Related U.S. Application Data**

(63) Continuation of application No. 29/596,356, filed on Mar. 7, 2017, now Pat. No. Des. 827,309.

**DESCRIPTION**

(51) **LOC (11) Cl.** ..... **04-99**

FIG. 1 is an isometric view of a front, top, and left side of an ornamental design for a makeup brush;

(52) **U.S. Cl.**

FIG. 2 is a front elevational view of the makeup brush of FIG. 1;

USPC ..... **D4/138**

FIG. 3 is a rear elevational view of the makeup brush of FIG. 1;

(58) **Field of Classification Search**

USPC ..... D4/104, 106, 110, 114, 116, 118, 119, D4/120, 121, 127, 128, 138, 132, 135, D4/199; D28/7, 57, 30, 73, 75, 76, 77, D28/89; D8/80, 83, 94, 107, 300, 301; D24/180; D32/51, 52; D19/108, 115, D19/125; 15/106, 159.1, 160, 176.1, 184, (Continued)

FIG. 4 is a right side elevational view of the makeup brush of FIG. 1;

FIG. 5 is a left side elevational view of the makeup brush of FIG. 1;

(56) **References Cited**

U.S. PATENT DOCUMENTS

RE16,869 E 2/1928 Goldman  
D116,216 S 8/1939 Brekke

FIG. 6 is a top plan view of the makeup brush of FIG. 1; and, FIG. 7 is a bottom plan view of the makeup brush of FIG. 1.

The dash-dash-dash-dash lines are for the purpose of illustrating environmental structure and form no part of the claimed design. The dash-dot-dash lines form no part of the claimed design and represent a boundary line.

(Continued)

**1 Claim, 4 Drawing Sheets**

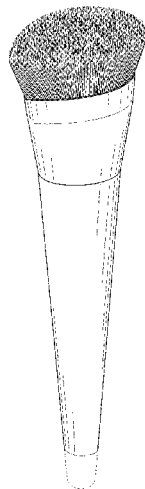

- (58) **Field of Classification Search**  
 USPC ..... 15/190-194; 132/289, 294, 298, 313,  
 132/317, 320  
 CPC ..... A46B 5/00; A46B 5/0016; A46B 5/26;  
 A46B 5/005; A46B 2200/20; A46B  
 2200/104; A46B 2200/1046; A46B  
 2200/202; A46B 2200/108; A46B  
 2200/1086; A46B 2200/1093; A46B  
 17/04; A46B 11/00; A46B 11/001; A46B  
 11/0003; A46B 11/0006; A46B 11/0013;  
 A46B 15/0055; A46B 15/0061; A46B  
 7/026; A61C 3/00; A61M 35/003; B05C  
 17/0205; B05C 17/04; B05C 1/06

See application file for complete search history.

(56) **References Cited**

U.S. PATENT DOCUMENTS

D139,381 S 11/1944 Harris  
 D189,374 S 11/1960 Harris  
 D238,631 S 2/1976 Leighton  
 D249,600 S 9/1978 Bowman  
 D258,240 S 2/1981 Takada et al.  
 D263,807 S 4/1982 Kingsford  
 D274,474 S 6/1984 Castiglioni  
 D275,040 S 8/1984 Holloway  
 D278,951 S 5/1985 Kalinsky  
 D278,952 S 5/1985 Kalinsky  
 D285,730 S 9/1986 Bulwick  
 D295,878 S 5/1988 Lovell  
 D304,392 S 11/1989 Reich  
 4,946,389 A 8/1990 Weissenburger  
 D312,729 S 12/1990 Auttajark  
 D319,736 S 9/1991 Thuresson et al.  
 D323,186 S 1/1992 Clark et al.  
 D327,979 S 7/1992 Carranza  
 D346,277 S 4/1994 Sherman et al.  
 D361,236 S 8/1995 Murgalo  
 D368,093 S 3/1996 Starck  
 5,542,144 A 8/1996 Forsline  
 D376,696 S 12/1996 Vogel, Jr.  
 D376,910 S 12/1996 Tuchman  
 D386,311 S 11/1997 Moskovich  
 D395,552 S 6/1998 Cunningham  
 D404,647 S 1/1999 Federighi  
 5,926,903 A 7/1999 Kim  
 D418,541 S 1/2000 Mayer  
 D418,601 S 1/2000 McGugan  
 6,039,051 A 3/2000 Dorf  
 D427,777 S 7/2000 Kim  
 D430,608 S 9/2000 Krieglstein et al.  
 D431,324 S 9/2000 Hirato et al.  
 D433,537 S 11/2000 Schoon et al.  
 D435,349 S 12/2000 Kim  
 D438,383 S 3/2001 Doat  
 D446,212 S 8/2001 Chang  
 D447,602 S 9/2001 Dumler et al.  
 D450,189 S 11/2001 Mink et al.  
 D451,285 S 12/2001 Andersson  
 D452,948 S 1/2002 Mink et al.  
 6,386,874 B2 5/2002 Bachmann et al.  
 D458,761 S 6/2002 Mason et al.  
 D460,111 S 7/2002 Veillon  
 D463,735 S 10/2002 Gobe  
 D469,180 S 1/2003 Mark  
 6,513,183 B2 2/2003 Dorf  
 D478,213 S 8/2003 Ping  
 D479,918 S 9/2003 Mink  
 D480,272 S 10/2003 Yang  
 D485,575 S 1/2004 Lovell  
 6,779,532 B2 8/2004 Dorf  
 D516,257 S 2/2006 Brackett et al.  
 D518,102 S 3/2006 Lovell  
 D522,866 S 6/2006 Bakic  
 D527,188 S 8/2006 Langer

D528,304 S 9/2006 Langer  
 D528,305 S 9/2006 Langer  
 D529,292 S 10/2006 Langer  
 D529,293 S 10/2006 Langer  
 D529,719 S 10/2006 Langer  
 D530,097 S 10/2006 Langer  
 D530,519 S 10/2006 Langer  
 D541,979 S 5/2007 Montoli  
 D571,105 S 6/2008 Godin  
 D571,559 S 6/2008 Riaz  
 D572,010 S 7/2008 Riaz  
 D573,348 S 7/2008 Dumler et al.  
 D573,349 S 7/2008 Dumler et al.  
 D574,154 S 8/2008 Dumler et al.  
 D574,155 S 8/2008 Dumler et al.  
 7,416,080 B1 8/2008 Langer  
 D598,655 S 8/2009 Thorpe et al.  
 D599,113 S 9/2009 Jackel-Marken  
 D599,117 S 9/2009 Dumler  
 D617,954 S 6/2010 L'Abbate  
 RE41,710 E 9/2010 Dumler et al.  
 RE41,711 E 9/2010 Dumler et al.  
 D625,522 S 10/2010 Riaz  
 D627,977 S 11/2010 Magallanes Orozco  
 D628,811 S 12/2010 Masuyama  
 D629,846 S 12/2010 Losel  
 D630,437 S 1/2011 Carey  
 D631,666 S 2/2011 Lim et al.  
 D632,086 S 2/2011 Kulik  
 D634,127 S 3/2011 Burgess et al.  
 D642,805 S 8/2011 Burgess et al.  
 D645,665 S 9/2011 Del Ponte  
 D650,012 S 12/2011 Losel  
 D655,006 S 2/2012 Rajaiyah et al.  
 D658,385 S 5/2012 Lim et al.  
 8,185,998 B2\* 5/2012 Xu ..... A46B 5/0095  
 132/120  
 D663,957 S 7/2012 Garcia  
 8,230,543 B2 7/2012 Shrier et al.  
 D666,008 S 8/2012 Boudreau  
 D676,663 S 2/2013 Ptok et al.  
 D676,666 S 2/2013 Nelson  
 D677,904 S 3/2013 Hammer  
 D678,682 S 3/2013 Hammer  
 D678,683 S 3/2013 Hammer  
 D678,684 S 3/2013 Hammer  
 D699,041 S 2/2014 Waitesmith  
 D702,554 S 4/2014 Cole et al.  
 D706,542 S 6/2014 Lavigne  
 D718,060 S 11/2014 Filho et al.  
 D718,941 S 12/2014 Matsuishi  
 9,089,200 B2\* 7/2015 Telwar ..... A46B 3/08  
 D743,632 S 11/2015 Schlickman  
 D746,010 S 12/2015 Xavier et al.  
 D747,835 S 1/2016 Barnard et al.  
 9,237,790 B2 1/2016 Takagi  
 D749,327 S 2/2016 Thierer et al.  
 D749,858 S 2/2016 Snook  
 D749,859 S 2/2016 Snook  
 D750,383 S 3/2016 Serrano  
 D752,149 S 3/2016 Fairweather  
 D753,769 S 4/2016 Ciriolo  
 D756,127 S 5/2016 Nicoline  
 D756,661 S 5/2016 Waitesmith  
 D757,441 S 5/2016 Hwang  
 D757,443 S 5/2016 Waitesmith  
 D757,447 S 5/2016 White  
 D758,742 S 6/2016 Nicoline  
 D762,988 S 8/2016 Xavier et al.  
 D763,676 S 8/2016 Filho et al.  
 D764,807 S 8/2016 Waitesmith  
 D765,421 S 9/2016 Cole  
 D766,586 S 9/2016 Hwang  
 D766,587 S 9/2016 Hwang  
 D767,903 S 10/2016 Lim  
 D768,998 S 10/2016 Kim et al.  
 D771,389 S 11/2016 Since  
 D776,440 S 1/2017 Jain  
 D776,941 S 1/2017 Nicoline

(56)

References Cited

U.S. PATENT DOCUMENTS

D778,067 S 2/2017 Jain  
 D778,617 S 2/2017 Jain  
 D778,618 S 2/2017 Jain  
 D778,619 S 2/2017 Jain  
 D778,620 S 2/2017 Jain  
 D778,621 S 2/2017 Jain  
 D778,623 S 2/2017 Jain  
 D779,137 S 2/2017 Taylor  
 D779,213 S 2/2017 Jain  
 D781,592 S 3/2017 Kaicker et al.  
 D781,593 S 3/2017 Kaicker  
 D782,138 S 3/2017 Xavier et al.  
 D782,198 S 3/2017 Hwang  
 D782,199 S 3/2017 Hwang  
 D782,201 S 3/2017 Hwang  
 D782,730 S 3/2017 Zhang et al.  
 D782,826 S 4/2017 Kim et al.  
 D783,291 S 4/2017 Lin  
 D787,190 S 5/2017 Machiorlette et al.  
 D787,191 S 5/2017 Hwang  
 D787,192 S 5/2017 Hwang  
 D787,193 S 5/2017 Hwang  
 D787,833 S 5/2017 Jain  
 9,642,441 B1 5/2017 Ajootian  
 D788,471 S 6/2017 Dunaway  
 D790,973 S 7/2017 Kern et al.  
 D793,090 S 8/2017 Allen et al.  
 D794,966 S 8/2017 Salm  
 D800,457 S 10/2017 Kaicker  
 D802,938 S 11/2017 Nicoline  
 D807,611 S 1/2018 Almarales  
 D817,546 S \* 5/2018 Barozzi ..... D28/7  
 D821,760 S \* 7/2018 Yan ..... D4/138  
 D827,308 S \* 9/2018 Nicoline ..... D4/138  
 D827,309 S \* 9/2018 Nicoline ..... D4/138  
 D827,310 S \* 9/2018 Allenback ..... D4/138  
 D829,006 S \* 9/2018 Richards ..... A46B 5/0095  
 D831,362 S \* 10/2018 Kim ..... D4/138  
 D831,974 S \* 10/2018 Nicoline ..... D4/138  
 D831,975 S \* 10/2018 Nicoline ..... D4/138  
 D831,976 S \* 10/2018 Nicoline ..... D4/199  
 10,098,446 B2 \* 10/2018 Telwar Kaicker ..... A46B 3/08  
 2002/0083953 A1 7/2002 Dorf  
 2006/0248669 A1 11/2006 Dovellos  
 2010/0101035 A1 4/2010 Nakamura  
 2010/0236004 A1 9/2010 Xu  
 2011/0017226 A1 1/2011 Choi

2011/0174680 A1 7/2011 Arvin et al.  
 2011/0284019 A1 11/2011 Fairweather  
 2012/0142545 A1 6/2012 Kingston et al.  
 2012/0298130 A1 11/2012 Telwar et al.  
 2013/0174860 A1 7/2013 Takagi  
 2014/0166041 A1 6/2014 King  
 2014/0331422 A1 11/2014 Lim  
 2015/0027495 A1 1/2015 Xavier et al.  
 2016/0128445 A1 5/2016 Lim  
 2016/0262528 A1 9/2016 Telwar  
 2017/0188691 A1 7/2017 Richards  
 2017/0265637 A1 9/2017 Telwar  
 2018/0153293 A1\* 6/2018 Dovellos ..... A46B 9/021  
 2018/0220786 A1\* 8/2018 Serposi ..... A46B 9/12

FOREIGN PATENT DOCUMENTS

CN 301855897 3/2012  
 CN 303866304 9/2016  
 CN 303901885 11/2016  
 EM 002910968-0001 12/2015  
 EM 002910968-0002 12/2015  
 EM 002910968-0003 12/2015  
 EM 002910968-0004 12/2015  
 EM 002910968-0005 12/2015  
 EM 002910968-0006 12/2015  
 EM 002910968-0007 12/2015  
 EM 002910968-0008 12/2015  
 EM 002910968-0009 12/2015  
 EM 002910968-0010 12/2015  
 EM 002910968-0011 12/2015  
 EM 002910968-0012 12/2015  
 EM 002910968-0013 12/2015  
 WO 2012142545 A2 10/2012

OTHER PUBLICATIONS

Iswarya, "Tmart 10pcs Professional Cosmetic Makeup Brush Set with Cream Colored Bag Review!!" I Am Girly Blog, Oct. 3, 2014, 9 pages. [URL] <http://i-am-girly.com/product-review/tmart-10-pcs-professional-cosmetic-makeup-brush-set-with-cream-colored-bag-review.html>.  
 "Real Techniques Point L Makeup Brush," Real Techniques, Retrieved from Internet Jan. 8, 2018, 5 pages. [URL] <https://realtechniques.com/point-l/p/1481>.  
 Tweet by Val Mendoza showing image of a set of 5 cosmetic brushes, Dec. 8, 2015, 9 pages. [URL] <https://twitter.com/rval78>.

\* cited by examiner

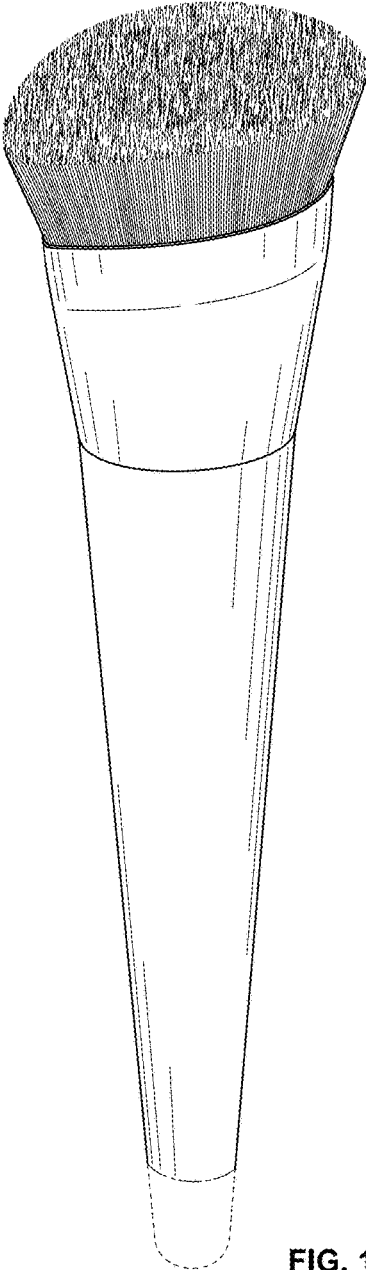

FIG. 1

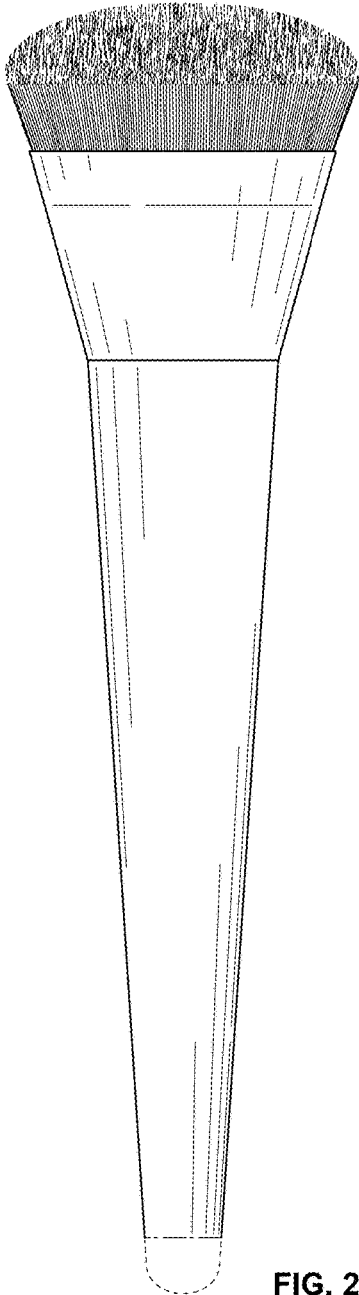

FIG. 2

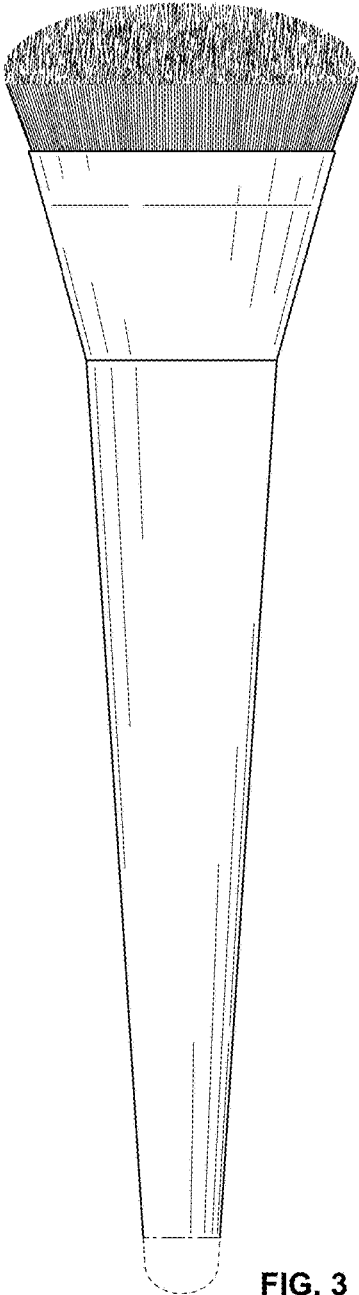

FIG. 3

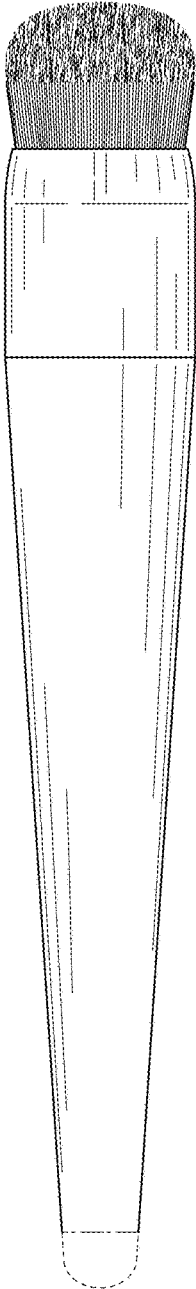

FIG. 4

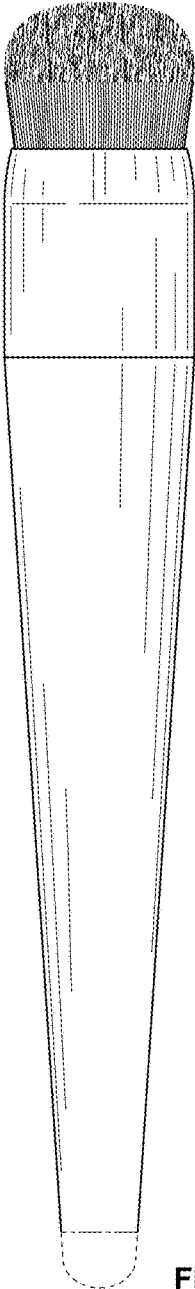

FIG. 5

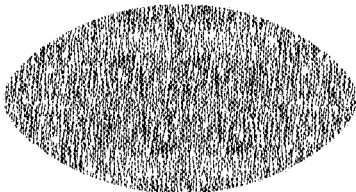

FIG. 6

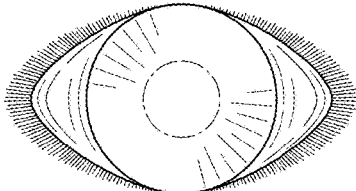

FIG. 7