



US00D866526S

(12) **United States Design Patent** (10) **Patent No.:** **US D866,526 S**  
**Pinto Couto et al.** (45) **Date of Patent:** **\*\* Nov. 12, 2019**

(54) **REMOTE CONTROL WIRELESS**  
(71) Applicant: **TECH4HOME, LDA**, São João da Madeira (PT)  
(72) Inventors: **Rosa Mariana Pinto Couto**, Sao Joao da Madeira (PT); **Tiago Matos Correia**, Sao Joao da Madeira (PT); **Tiago Jorge Da Costa e Sousa**, Sao Joao da Madeira (PT); **Joao Nuno Monteiro dos Santos**, Sao Joao da Madeira (PT)

D499,717 S \* 12/2004 Zuege ..... D14/218  
D504,677 S \* 5/2005 Kaminski ..... D14/218  
D518,031 S \* 3/2006 Wu ..... D14/218  
D538,788 S \* 3/2007 Reimann ..... D14/218  
D540,268 S \* 4/2007 Derocher ..... D13/168  
D551,659 S \* 9/2007 Shih ..... D14/218  
D580,916 S \* 11/2008 Huang ..... D14/218  
D591,272 S \* 4/2009 Vitito ..... D14/218  
D594,850 S \* 6/2009 Yan ..... D14/218  
D614,605 S \* 4/2010 Teh ..... D14/218

(Continued)

*Primary Examiner* — Michael A. Pratt  
(74) *Attorney, Agent, or Firm* — Lucas & Mercanti, LLP

(73) Assignee: **TECH4HOME, LDA.**, Sao Joao da Madeira (PT)

(\*\*) Term: **15 Years**

(21) Appl. No.: **35/504,383**

(22) Filed: **Oct. 18, 2017**

(80) **Hague Agreement Data**

Int. Filing Date: **Oct. 18, 2017**  
Int. Reg. No.: **DM/099268**  
Int. Reg. Date: **Oct. 18, 2017**  
Int. Reg. Pub. Date: **Feb. 2, 2018**

(51) **LOC (12) Cl.** ..... **14-01**

(52) **U.S. Cl.**  
USPC ..... **D14/218**

(58) **Field of Classification Search**  
USPC ..... D14/218  
CPC ..... G08C 2201/92; G08C 2201/30  
See application file for complete search history.

(56) **References Cited**

**U.S. PATENT DOCUMENTS**

D381,661 S \* 7/1997 Althans ..... D14/218  
D429,718 S \* 8/2000 Rudolph ..... D14/218  
D432,525 S \* 10/2000 Beecroft ..... D14/218  
6,130,624 A \* 10/2000 Guyer ..... G08C 17/00  
340/12.55  
D498,748 S \* 11/2004 Borsboom ..... D14/218

(57) **CLAIM**

The ornamental design for a remote control wireless, as shown and described.

**DESCRIPTION**

- 1.1: Rear
- 1.2: Side
- 1.3: Side
- 1.4: Bottom
- 1.5: Front
- 1.6: Perspective
- 1.7: Top
- 3.1: Bottom
- 3.2: Rear
- 3.3: Side
- 3.4: Front
- 3.5: Top
- 3.6: Side
- 3.7: Perspective
- 4.1: Rear
- 4.2: Bottom
- 4.3: Side
- 4.4: Side
- 4.5: Top
- 4.6: Front
- 4.7: Perspective

**1 Claim, 21 Drawing Sheets**

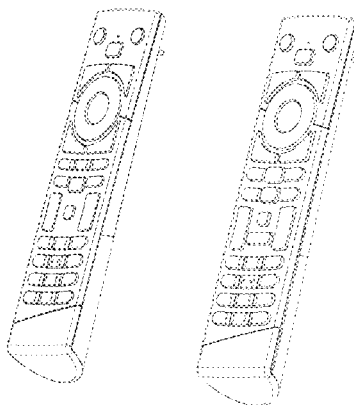

(56)

References Cited

U.S. PATENT DOCUMENTS

D615,965	S	*	5/2010	Yokota	.....	D14/218
D626,531	S	*	11/2010	Farmer	.....	D14/218
D628,982	S	*	12/2010	Tellier	.....	D14/218
D628,986	S	*	12/2010	VanDuy	.....	D14/218
D639,278	S	*	6/2011	Chai	.....	D14/218
D647,509	S	*	10/2011	Maier	.....	D14/218
D648,327	S	*	11/2011	Maier	.....	D14/218
D649,531	S	*	11/2011	Dawson	.....	D14/218
D650,365	S	*	12/2011	McManigal	.....	D14/218
D652,820	S	*	1/2012	Peh	.....	D14/218
D658,636	S	*	5/2012	Maier	.....	D14/218
D664,521	S	*	7/2012	VanDuy	.....	D14/218
D671,529	S	*	11/2012	Zalianskas	.....	D14/218
D673,934	S	*	1/2013	Shin	.....	D14/218
D679,266	S	*	4/2013	Shin	.....	D14/218
D699,223	S	*	2/2014	Maier	.....	D14/218
D703,187	S	*	4/2014	Maier	.....	D14/218
D705,755	S	*	5/2014	Zaslavsky	.....	D14/218
D722,046	S	*	2/2015	Kuh	.....	D14/218
D724,062	S	*	3/2015	Feldstein	.....	D14/218
D724,567	S	*	3/2015	Buch	.....	D14/218
D724,568	S	*	3/2015	Peh	.....	D14/218
D726,164	S	*	4/2015	Feldstein	.....	D14/218
D729,209	S	*	5/2015	McManigal	.....	D14/218
D735,166	S	*	7/2015	Hansen	.....	D14/218
D735,167	S	*	7/2015	Buch	.....	D14/218
D742,857	S	*	11/2015	Andresen	.....	D14/218
D743,944	S	*	11/2015	Karrman	.....	D14/218
D752,554	S	*	3/2016	Valeur	.....	D14/218
D753,635	S	*	4/2016	Ko	.....	D14/218
D755,758	S	*	5/2016	Maier	.....	D14/218
D760,198	S	*	6/2016	Kim	.....	D14/218
D760,199	S	*	6/2016	Bu	.....	D14/218
D760,699	S	*	7/2016	Peh	.....	D14/218
D760,700	S	*	7/2016	Peh	.....	D14/218
D764,443	S	*	8/2016	Cai	.....	D14/218
D765,622	S	*	9/2016	Chong	.....	D14/218
D768,605	S	*	10/2016	Wong	.....	D14/218
D774,493	S	*	12/2016	Wong	.....	D14/218
D784,295	S	*	4/2017	VanDuy	.....	D14/218
D786,833	S	*	5/2017	Sirpal	.....	D14/218
D788,743	S	*	6/2017	Cha	.....	D14/218
D790,513	S	*	6/2017	Brown	.....	D14/218
D791,104	S	*	7/2017	Goetzke	.....	D14/218
D795,842	S	*	8/2017	Cha	.....	D14/218
D796,483	S	*	9/2017	Einaudi	.....	D14/218
D797,671	S	*	9/2017	Andersson	.....	D13/122
D798,272	S	*	9/2017	Desagre	.....	D14/218
D798,273	S	*	9/2017	Jackson	.....	D14/218
D798,841	S	*	10/2017	Park	.....	D14/218
D803,815	S	*	11/2017	Maier	.....	D14/218
D807,861	S	*	1/2018	VanDuy	.....	D14/218
D808,364	S	*	1/2018	Lo	.....	D14/218
D808,930	S	*	1/2018	Lee	.....	D14/218
D808,931	S	*	1/2018	Maier	.....	D14/218
D809,485	S	*	2/2018	McManigal	.....	D14/218
D811,372	S	*	2/2018	Moresco	.....	D14/218
D811,373	S	*	2/2018	Lee	.....	D14/218
D812,592	S	*	3/2018	Lagerstedt	.....	D14/218
D818,445	S	*	5/2018	Altonen	.....	D13/168
D821,334	S	*	6/2018	McRoberts	.....	D13/168
D823,265	S	*	7/2018	Meda	.....	D13/168
D823,282	S	*	7/2018	Kim	.....	D14/218
D823,834	S	*	7/2018	Wang	.....	D14/218
D824,368	S	*	7/2018	Kacin	.....	D14/218
D824,369	S	*	7/2018	Ducret	.....	D14/218
D824,863	S	*	8/2018	McRoberts	.....	D13/168
D825,494	S	*	8/2018	Ryan	.....	D13/168
D825,532	S	*	8/2018	Maletz	.....	D14/218
D828,336	S	*	9/2018	Matvienko	.....	D14/218

\* cited by examiner

1.1

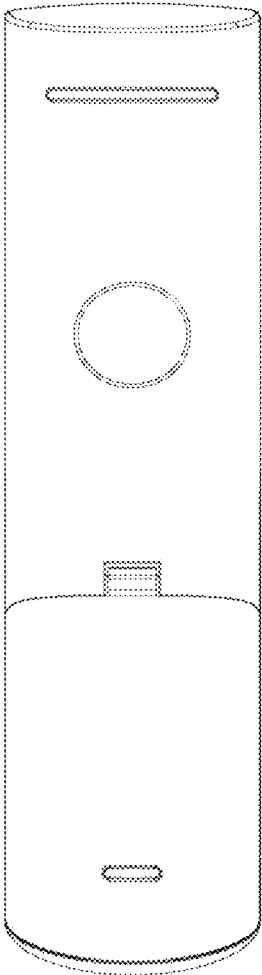

1.2

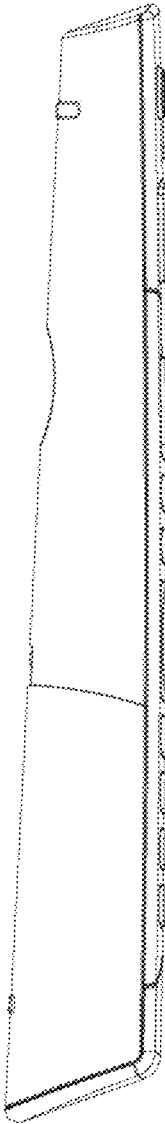

1.3

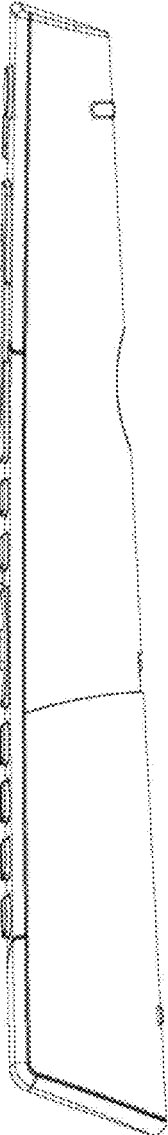

1.4



1.5

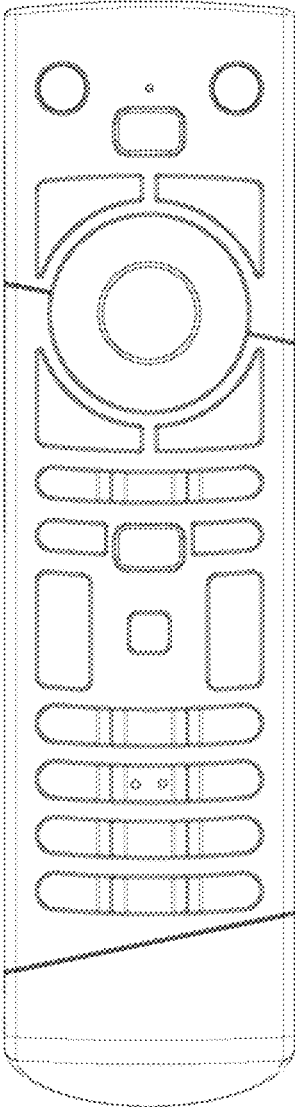

1.6

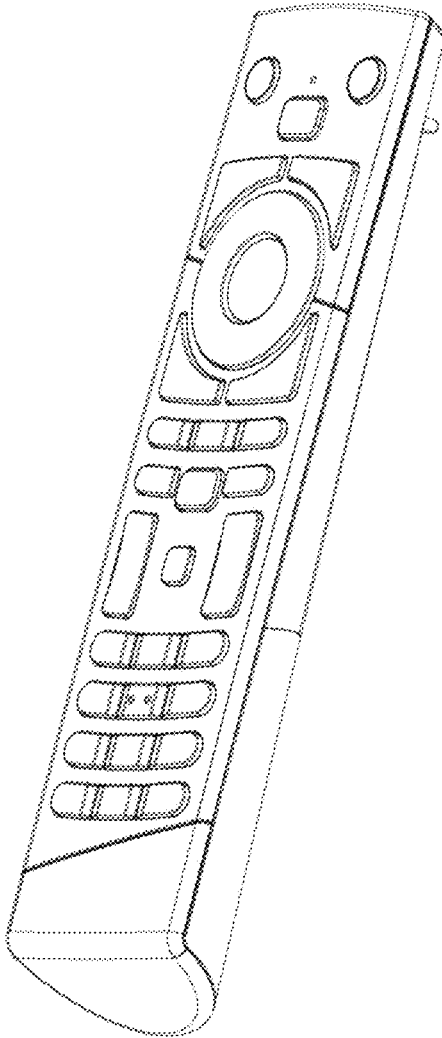



1.7



3.1



3.2

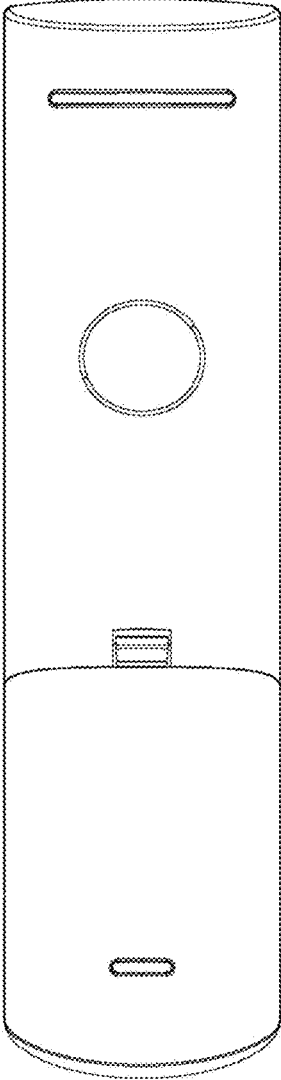

3.3

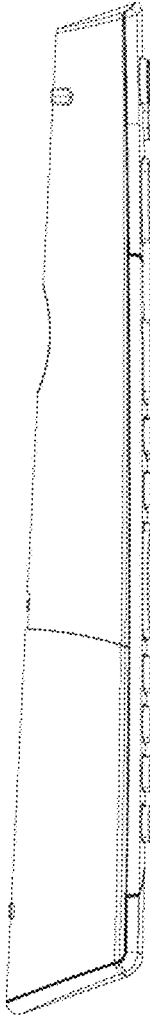

3.4

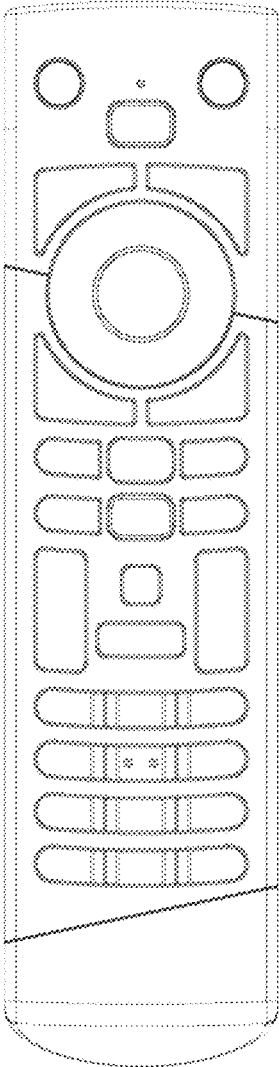

3.5



3.6

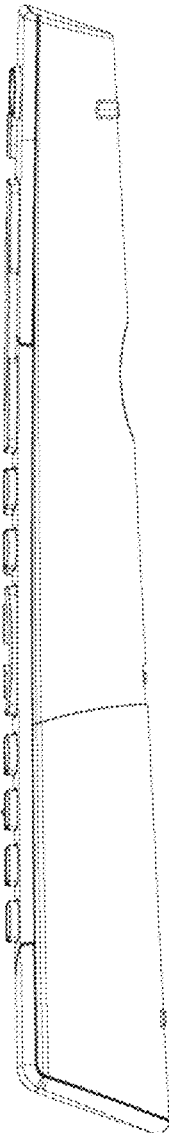

3.7

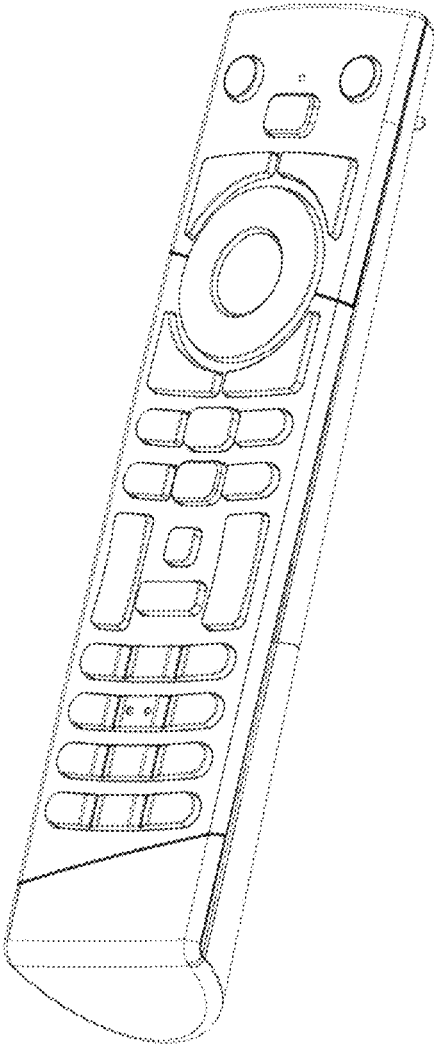



4.1

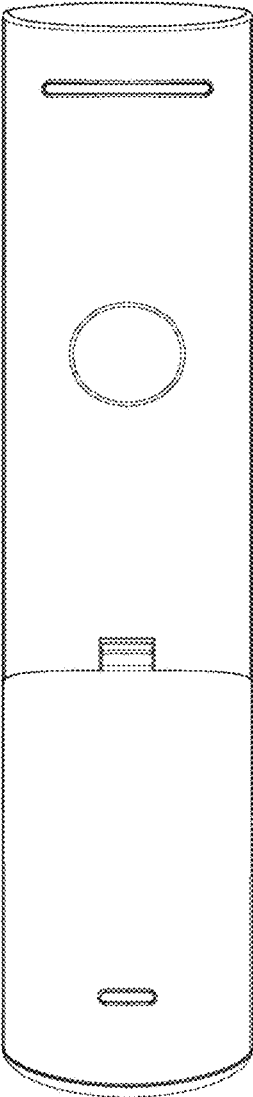

4.2

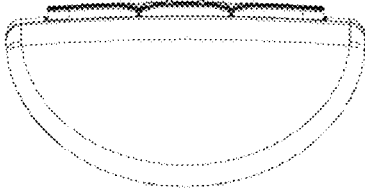

4.3

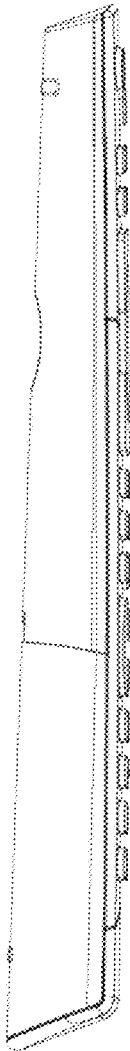

4.4

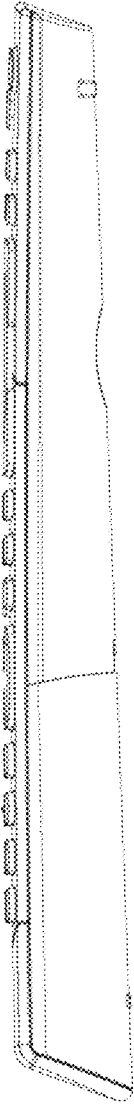

4.5



4.6

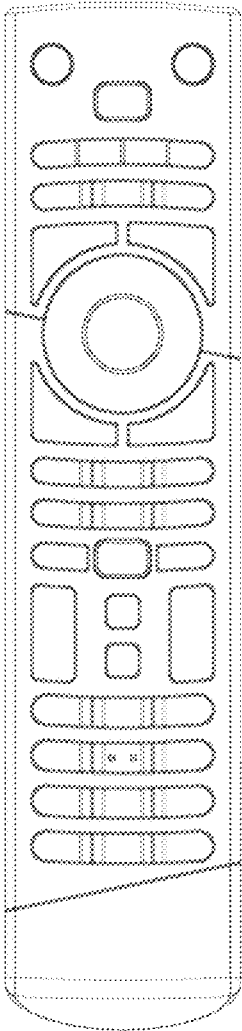

4.7

