



US00D917153S

(12) **United States Design Patent**
Denei et al.

(10) **Patent No.:** **US D917,153 S**
(45) **Date of Patent:** **** Apr. 27, 2021**

- (54) **PILL CONTAINER**
- (71) Applicant: **Pillo, Inc.**, Boston, MA (US)
- (72) Inventors: **Simone Denei**, Genoa (IT); **Davide Bolei**, Rezzoaglio (IT); **Jeffrey A. Feehan**, Hudson, MA (US); **Emanuele Baglini**, Chiavari (IT)
- (73) Assignee: **Pillo, Inc.**, Boston, MA (US)
- (**) Term: **15 Years**
- (21) Appl. No.: **29/713,748**
- (22) Filed: **Nov. 18, 2019**
- (51) **LOC (13) Cl.** **03-01**
- (52) **U.S. Cl.**
USPC **D3/203.4**
- (58) **Field of Classification Search**
USPC D3/201, 203.1–203.4, 273, 294, 295;
D9/730, 731, 756
CPC A61J 1/00; A61J 1/03; A61J 7/04; A61J 7/0076; A61J 7/0084; B65D 83/0083; B65D 83/04; B65D 83/0445; B65D 83/0454; B65D 83/0463; B65D 83/0481
See application file for complete search history.

- 4,128,188 A * 12/1978 White B65D 83/0454
221/2
- D278,513 S * 4/1985 Ebeling D3/203.3
- 4,667,845 A * 5/1987 Frazier B65D 83/0463
116/308
- 4,915,256 A * 4/1990 Tump B65D 83/0463
116/308
- D328,703 S * 8/1992 Klumpyan D3/203.4
- D348,219 S * 6/1994 Goldberg D3/203.4
- 5,397,017 A * 3/1995 Muza A61J 7/0046
206/538
- D380,378 S * 7/1997 Wood D9/731
- D382,198 S * 8/1997 Mulhauser B65D 83/04
D3/203.4
- D384,283 S * 9/1997 Davies D9/731
- D398,444 S * 9/1998 Ricci G07F 13/025
D3/203.2
- D405,361 S * 2/1999 Cameron G07F 17/0092
D9/731

(Continued)

Primary Examiner — Steven J Czyz
(74) *Attorney, Agent, or Firm* — Wolf, Greenfield & Sacks, P.C.

(57) **CLAIM**
The ornamental design for a pill container, as shown and described.

DESCRIPTION

FIG. 1 is a top, front perspective view of a pill container according to our new design;
FIG. 2 is a front elevation view thereof;
FIG. 3 is a rear elevation view thereof;
FIG. 4 is a left side elevation view thereof;
FIG. 5 is a right side elevation view thereof;
FIG. 6 is a top plan view thereof;
FIG. 7 is a bottom plan view thereof; and,
FIG. 8 is a bottom, front perspective view thereof.
The broken lines illustrate portions of the pill container that form no part of the claimed design.

1 Claim, 8 Drawing Sheets

- (56) **References Cited**
U.S. PATENT DOCUMENTS
D189,888 S * 3/1961 Tapper et al. D9/731
3,220,615 A * 11/1965 Spatz B65D 83/0083
222/252
3,831,808 A * 8/1974 Bender A61J 7/04
221/197
3,871,551 A * 3/1975 Bender B65D 83/0409
221/8
3,995,767 A * 12/1976 Brindley B65D 83/0454
221/82
4,083,452 A * 4/1978 Rossmo A61J 7/04
116/308

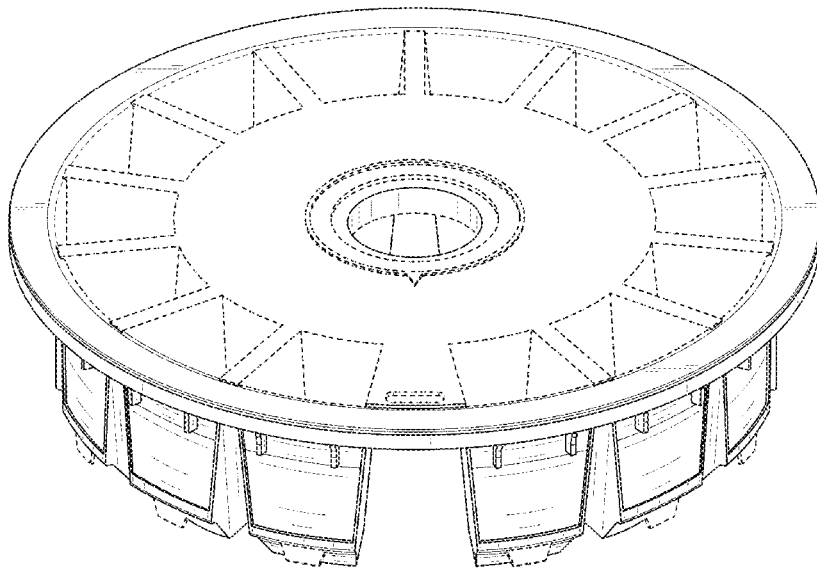

(56)

References Cited

U.S. PATENT DOCUMENTS

D420,904 S *	2/2000	Finkelston	D9/731	D563,095 S *	3/2008	Sabbag	D3/203.3
D423,925 S *	5/2000	Finkelston	D9/731	7,543,718 B2 *	6/2009	Simon	G07F 13/025 221/13
6,193,103 B1 *	2/2001	Clarijs	B65D 83/0454 221/25	D600,441 S *	9/2009	Estrada	D3/203.3
6,325,241 B1 *	12/2001	Garde	B65D 83/0454 206/533	7,587,259 B2 *	9/2009	Berg	G07F 17/0092 700/236
D459,873 S *	7/2002	Stillwell	D3/203.4	7,661,384 B2 *	2/2010	Mataya	G09F 11/23 116/311
6,651,840 B1 *	11/2003	Van Dullemen	B65B 69/0058 221/88	7,735,684 B2 *	6/2010	Coe	B65D 83/0409 221/265
D502,801 S *	3/2005	Baum	B65B 1/00 D3/203.3	8,068,934 B2 *	11/2011	Saltsov	A61J 7/0084 700/242
D514,804 S *	2/2006	Harvie	G07F 17/0092 D3/203.4	8,201,691 B1 *	6/2012	Chowdhury	A61J 1/03 206/534
7,128,213 B2 *	10/2006	Tung	A61J 7/04 206/538	D746,046 S *	12/2015	Lee	D3/203.3
7,147,127 B2 *	12/2006	Lepke	B65D 83/0454 221/4	9,218,458 B2 *	12/2015	Baarman	A61J 7/0076
7,159,720 B2 *	1/2007	Pearson	B65D 83/04 206/533	9,284,111 B2 *	3/2016	Huang	B65B 1/00
7,293,673 B2 *	11/2007	Savage	E05B 65/0003 221/122	9,333,653 B2 *	5/2016	Huang	G07F 17/0092
					10,279,985 B2 *	5/2019	Mills	A61J 7/0481
					10,292,906 B1 *	5/2019	Gershoni	A61J 7/0427
					10,555,874 B2 *	2/2020	Feng	A61J 7/0481
					10,737,873 B2 *	8/2020	Lebon	B65D 47/06
					10,892,048 B2 *	1/2021	Reddy	A61J 1/03

* cited by examiner

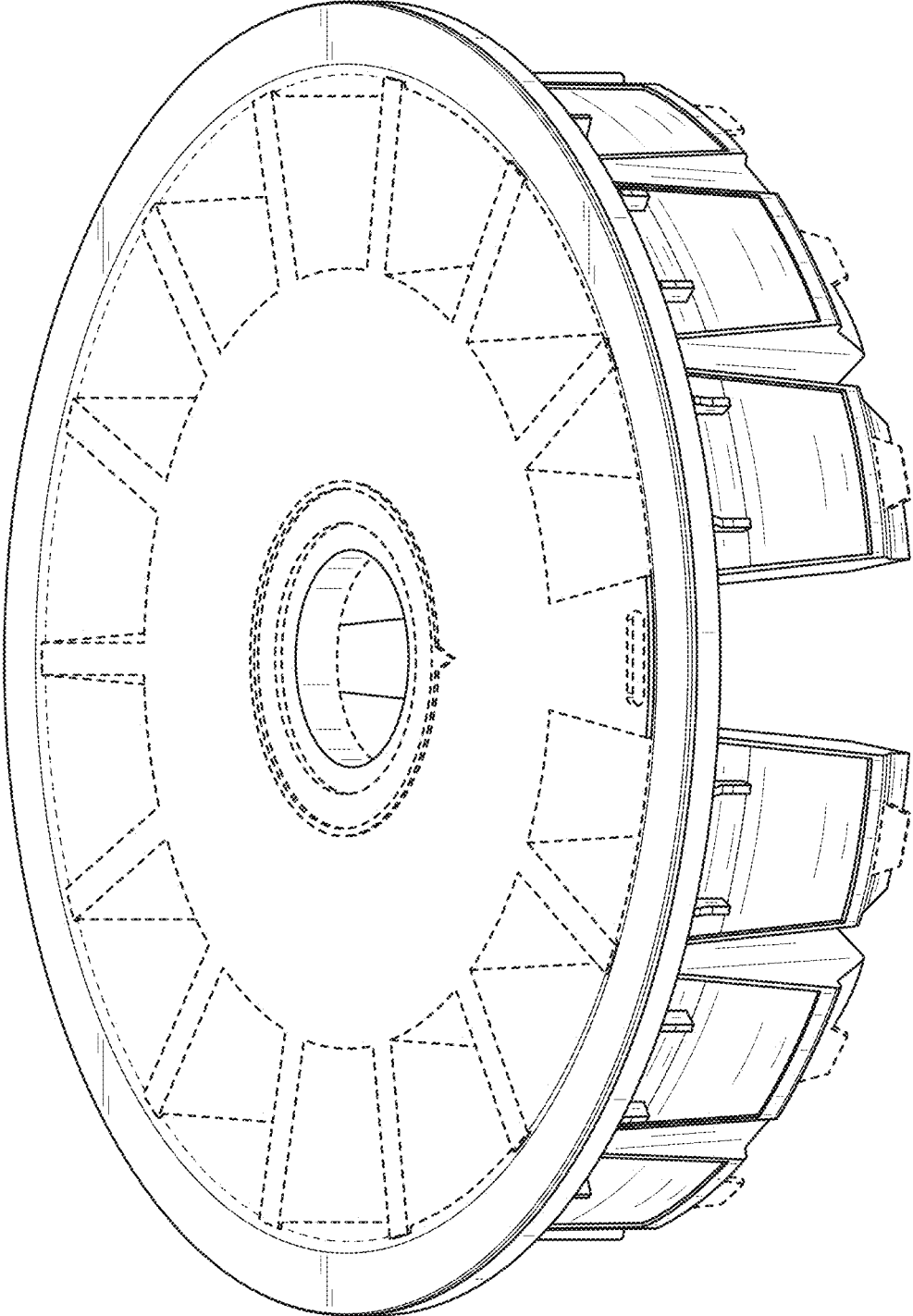

FIG. 1

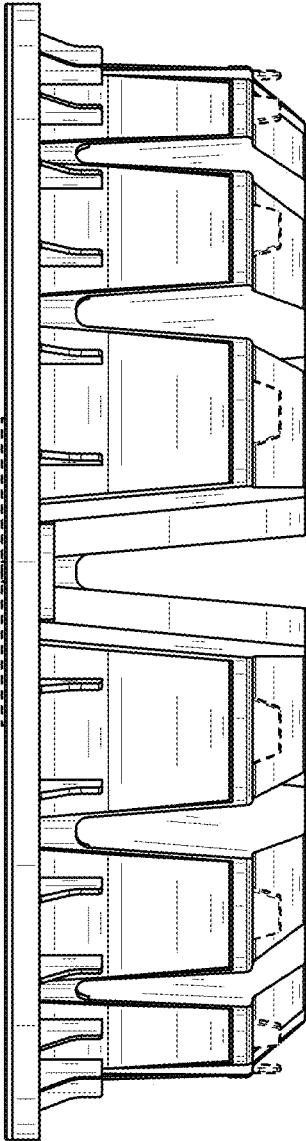

FIG. 2

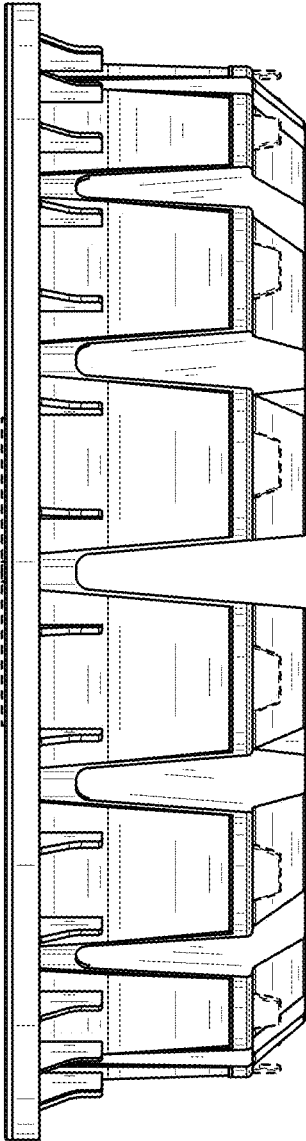

FIG. 3

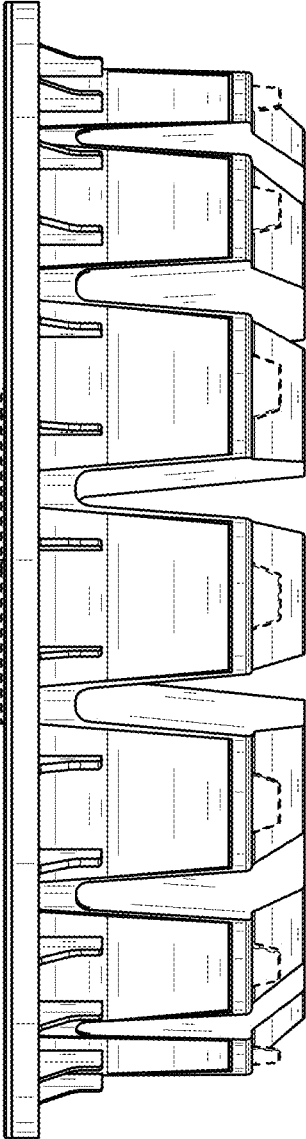

FIG. 4

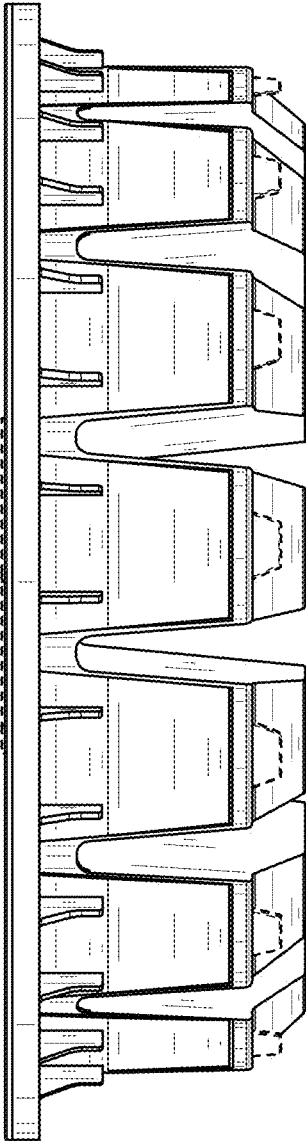

FIG. 5

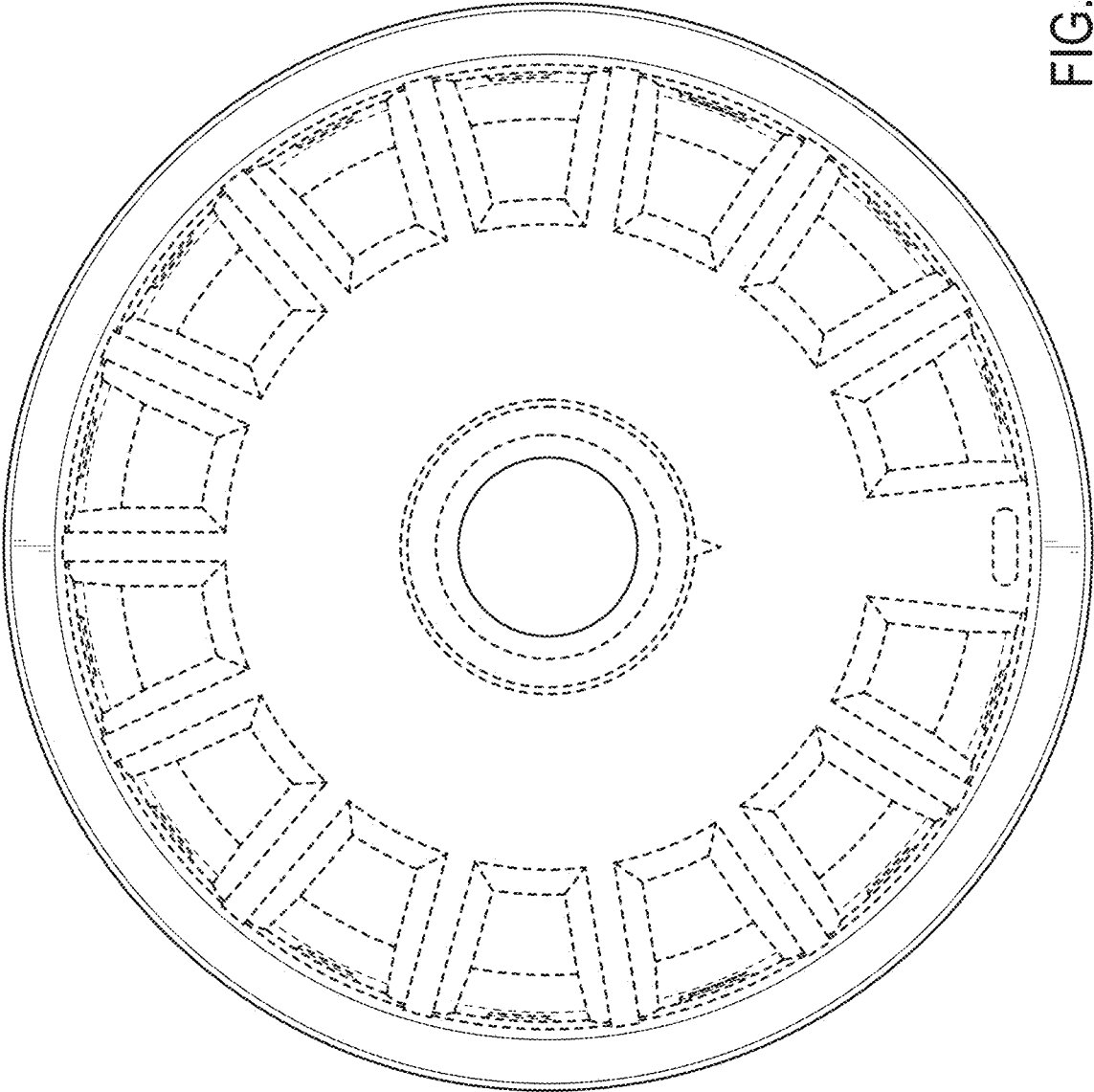

FIG. 6

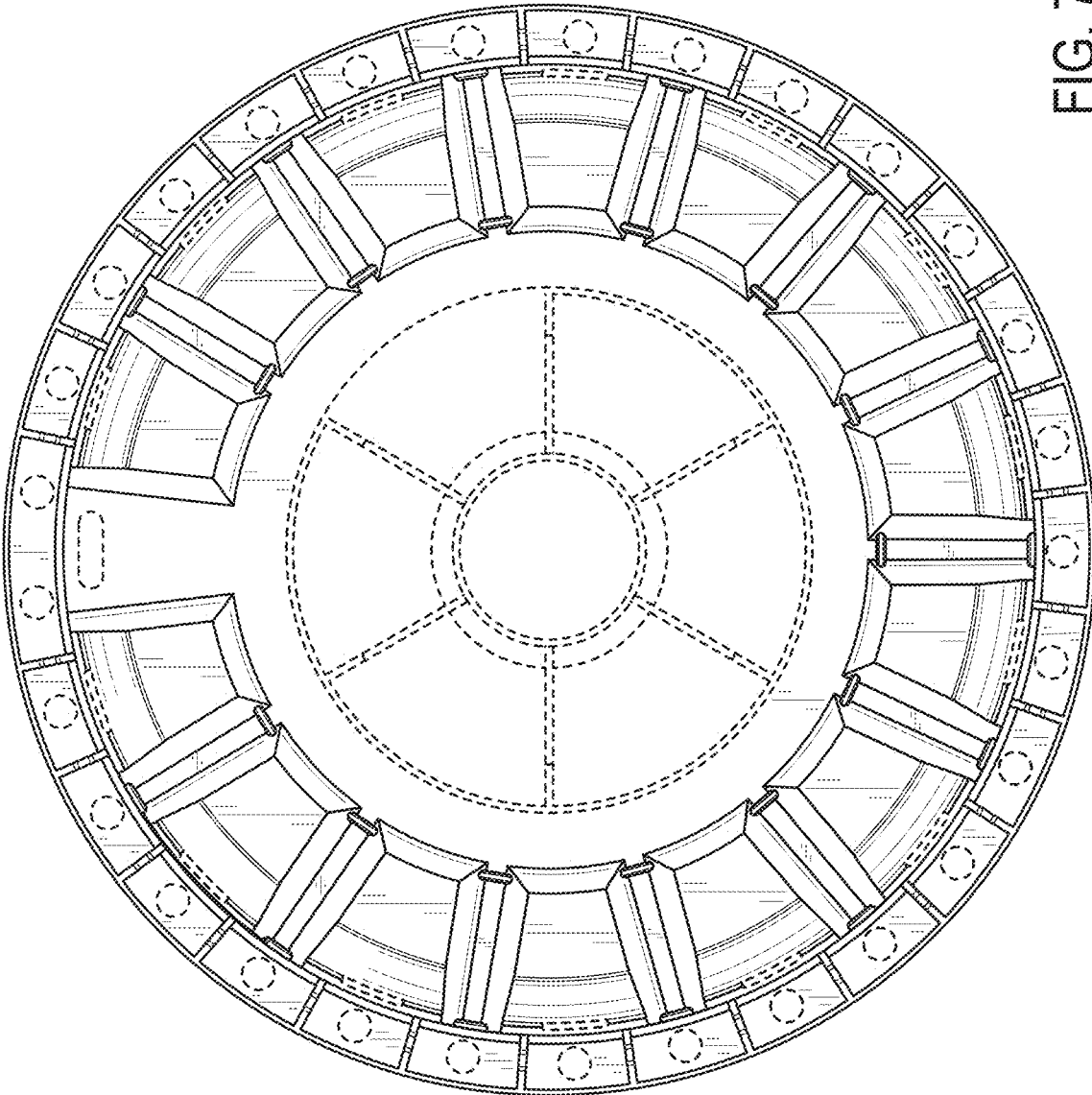

FIG. 7

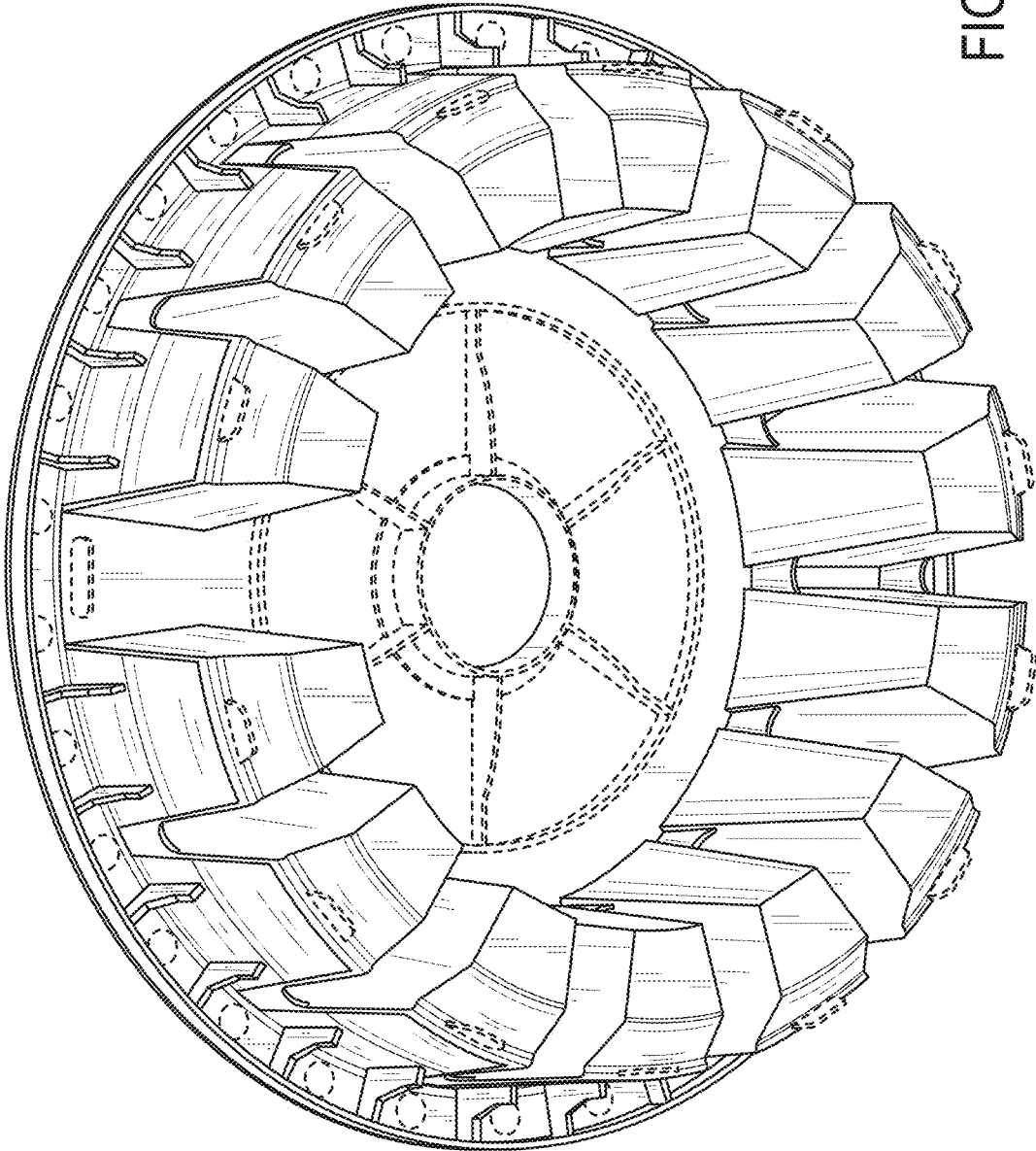

FIG. 8