



US00D858721S

(12) **United States Design Patent**
Gori et al.

(10) **Patent No.:** **US D858,721 S**

(45) **Date of Patent:** **** Sep. 3, 2019**

(54) **GUTTER GUARD REAR RECEIVER**

(71) Applicant: **LEAFFILTER NORTH, LLC**,
Hudson, OH (US)

(72) Inventors: **Michael Gori**, Norton, OH (US);
Michael J. Peck, Fairlawn, OH (US);
Scott M. Garbe, Massillon, OH (US)

(73) Assignee: **LEAFFILTER NORTH, LLC**,
Hudson, OH (US)

(**) Term: **15 Years**

(21) Appl. No.: **29/647,735**

(22) Filed: **May 15, 2018**

(51) **LOC (12) Cl.** **23-01**

(52) **U.S. Cl.**
USPC **D23/267**; D25/119

(58) **Field of Classification Search**
USPC D23/259–260, 267, 209, 365, 393;
D25/119, 121–124, 133, 141–142, 48.2,
D25/120, 131, 136, 138–139, 143–144,
D25/164, 199; 52/11–16, 60, 96–97
CPC ... E04D 13/076; E04D 13/072; E04D 13/064;
E04D 13/068; E04D 13/158; E04D
13/0641; E04D 13/0459; E04D 13/0477;
E04D 13/0481; E04D 13/15
See application file for complete search history.

(56) **References Cited**

U.S. PATENT DOCUMENTS

D210,935 S * 5/1968 Cook D25/119
D498,309 S * 11/2004 Koerner D25/164

D703,307 S * 4/2014 Little D23/393
D734,498 S * 7/2015 Batres D25/136
D734,499 S * 7/2015 Batres D25/136
D734,871 S * 7/2015 Wright D25/119
D767,382 S * 9/2016 Libreiro D25/119
D794,833 S * 8/2017 Singh D25/119
2007/0119105 A1* 5/2007 MacDonald E04F 13/0826
52/235

* cited by examiner

Primary Examiner — Eric L. Goodman

Assistant Examiner — Amy C. Wierenga

(74) *Attorney, Agent, or Firm* — Benesch, Friedlander,
Coplan & Aronoff LLP

(57) **CLAIM**

What is claimed is the ornamental design of a gutter guard rear receiver, as shown and described.

DESCRIPTION

FIG. 1 is a perspective view of a gutter guard rear receiver; FIG. 2 is a right-side elevation view of the gutter guard rear receiver of FIG. 1; FIG. 3 is a left-side elevation view of the gutter guard rear receiver of FIG. 1; FIG. 4 is a front elevation view of the gutter guard rear receiver of FIG. 1; FIG. 5 is a rear elevation view of the gutter guard rear receiver of FIG. 1; FIG. 6 is a top plan view of the gutter guard rear receiver of FIG. 1; and, FIG. 7 is a bottom plan view of the gutter guard rear receiver of FIG. 1.

The broken lines depict portions of the article that form no part of the claimed design.

1 Claim, 3 Drawing Sheets

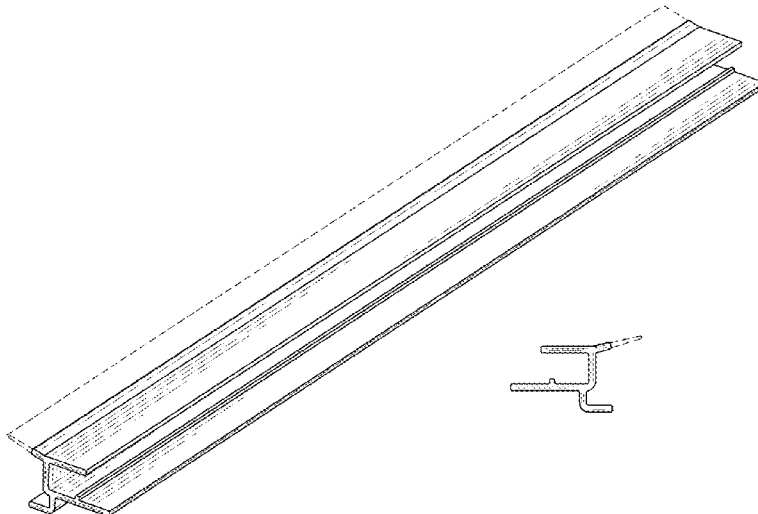

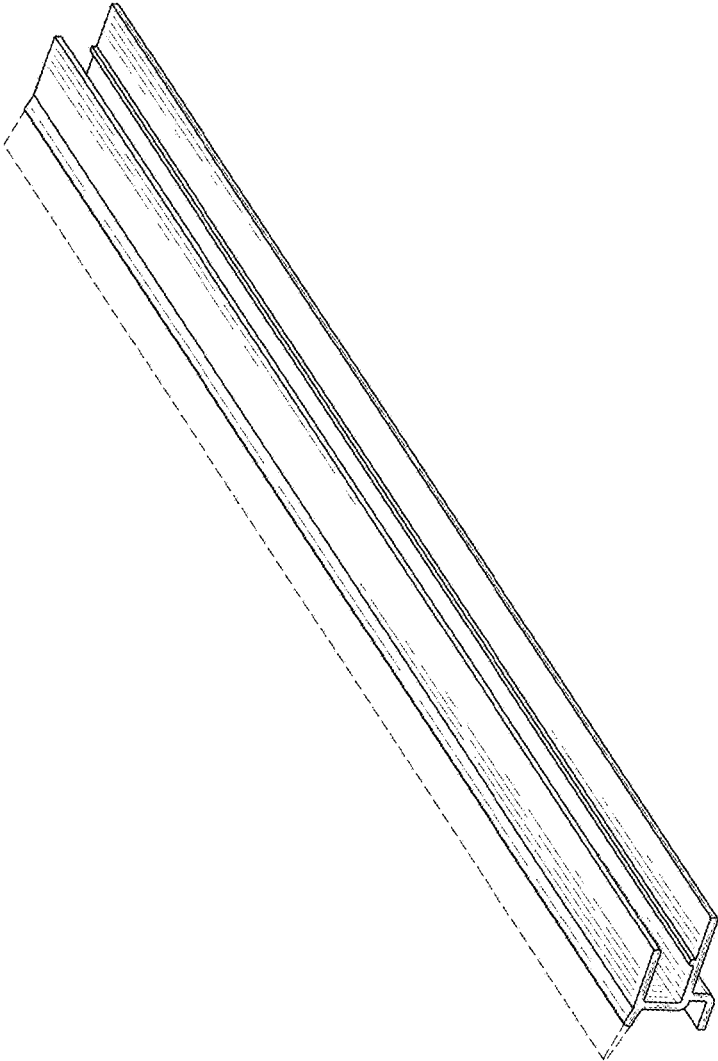

FIG. 1

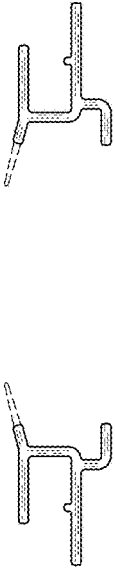

FIG. 3

FIG. 2

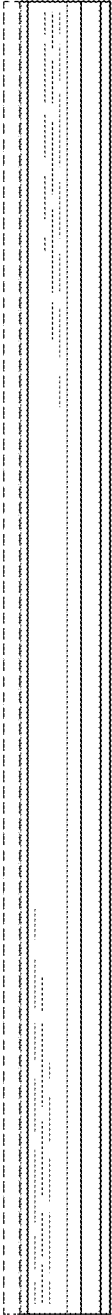

FIG. 4

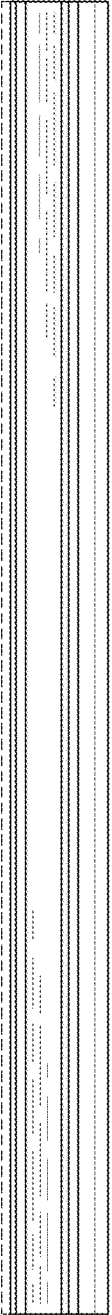

FIG. 5

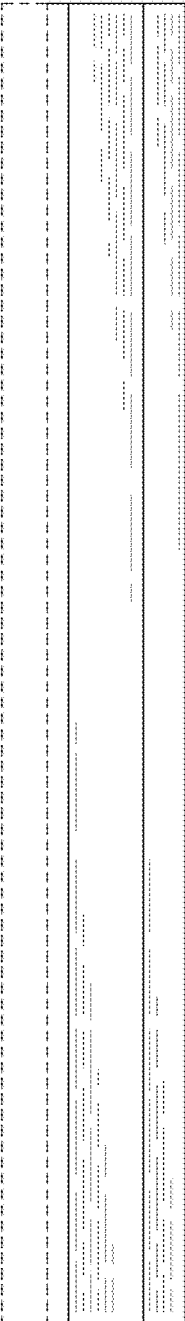

FIG. 6

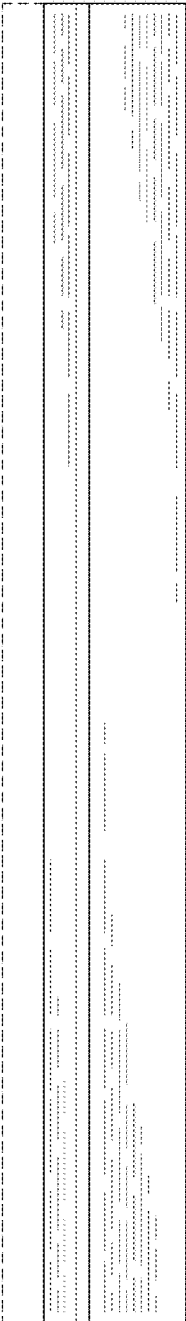

FIG. 7