



US00D781281S

(12) **United States Design Patent** (10) **Patent No.:** **US D781,281 S**
Lyles et al. (45) **Date of Patent:** **** Mar. 14, 2017**

(54) **INFORMATION HANDLING SYSTEM**

OTHER PUBLICATIONS

(71) Applicant: **Dell Products L.P.**, Round Rock, TX (US)

Apple, Macbook (13-inch, Late 2009), Technical Specifications, https://support.apple.com/kb/SP579?locale=en_US, printed Feb. 25, 2016.

(72) Inventors: **Justin C. Lyles**, Austin, TX (US);
Brian Hargrove Leonard, Austin, TX (US)

* cited by examiner

(73) Assignee: **Dell Products L.P.**, Round Rock, TX (US)

Primary Examiner — Freda S Nunn

(**) Term: **15 Years**

(74) *Attorney, Agent, or Firm* — Terrile, Cannatti, Chambers & Holland, LLP; Stephen A. Terrile

(21) Appl. No.: **29/555,885**

(22) Filed: **Feb. 25, 2016**

(57) **CLAIM**

(51) **LOC (10) Cl.** **14-02**

The ornamental design for an information handling system, as shown and described.

(52) **U.S. Cl.**

USPC **D14/315**

(58) **Field of Classification Search**

USPC D14/315-327; D18/1, 2, 7, 11;
235/145 A, 145 R; 341/22, 23; 345/104,
345/156, 168, 169, 173; 361/679.08,
361/679.09, 679.11, 679.26, 679.27
CPC G06F 1/16; G06F 1/1616; G06F 1/1626;
G06F 1/1632; G06F 1/1613; G06F
1/1601; G06F 1/1618; G06F 1/162; G06F
1/166; G06F 1/1654; G06F 1/1681; G06F
1/1637; G06F 1/1688; H01R 35/02;
H03M 11/00; G09B 13/04; H03K 17/94;
G09G 5/00; F16M 11/10; H05K 5/00;
H05K 7/02; H04M 1/0237

See application file for complete search history.

DESCRIPTION

FIG. 1 is a front perspective view of the information handling system in a closed position comprising the present invention;

FIG. 2 is a front view thereof in a closed position;

FIG. 3 is a rear view thereof in a closed position;

FIG. 4 is a right side view thereof in a closed position;

FIG. 5 is a left side view thereof in a closed position;

FIG. 6 is a top view thereof;

FIG. 7 is a bottom view thereof; and,

FIG. 8 is a front perspective view thereof in an open position.

Broken lines shown in the drawings illustrate portions of the information handling system, and form no part of the claimed design.

(56) **References Cited**

U.S. PATENT DOCUMENTS

6,067,224 A * 5/2000 Nobuchi G06F 1/1688
361/679.21
D624,911 S * 10/2010 Lee D14/315
D676,041 S * 2/2013 McManigal D14/315
2011/0255727 A1* 10/2011 Azuchi G06F 1/1616
381/333

1 Claim, 5 Drawing Sheets

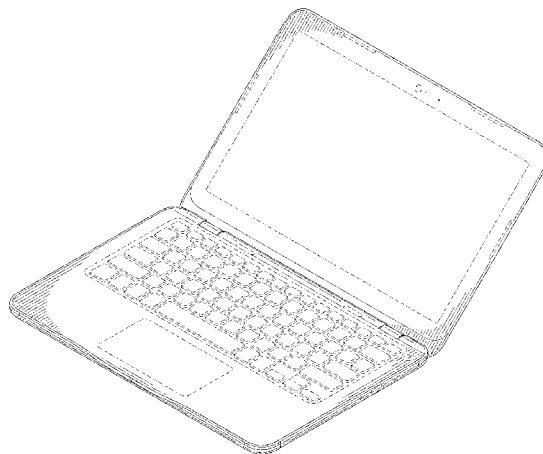

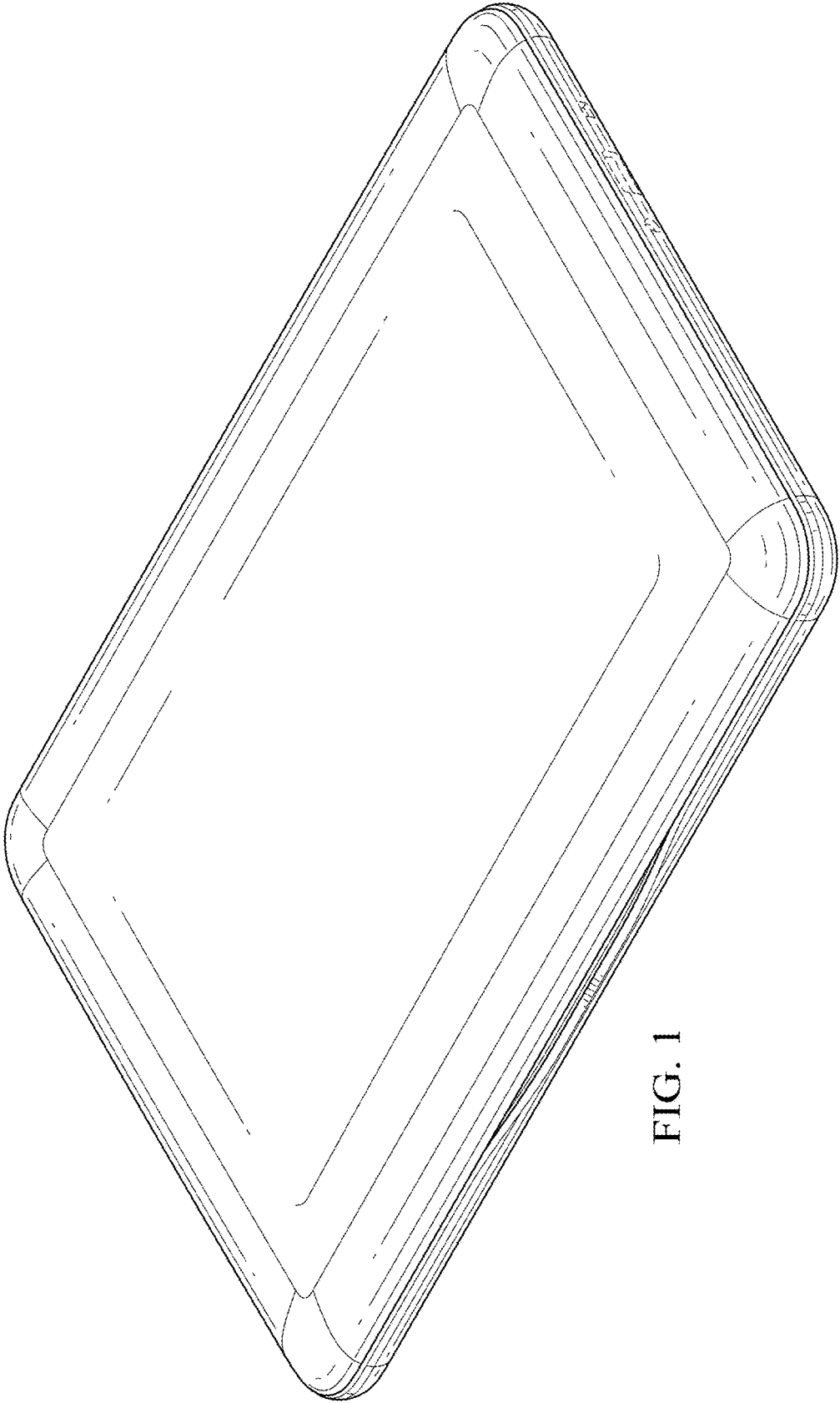

FIG. 1



FIG. 2

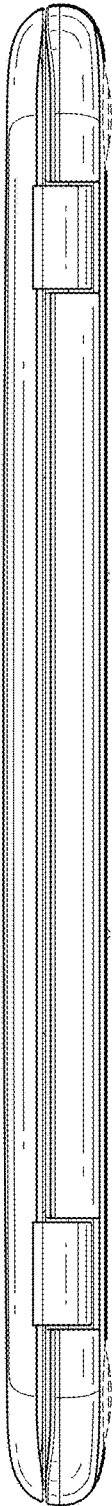

FIG. 3

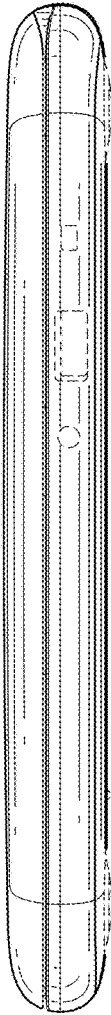

FIG. 4

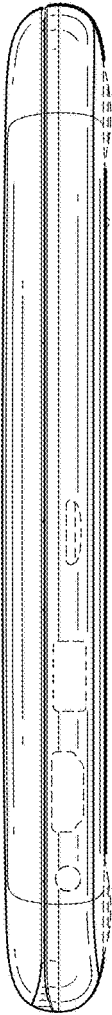

FIG. 5

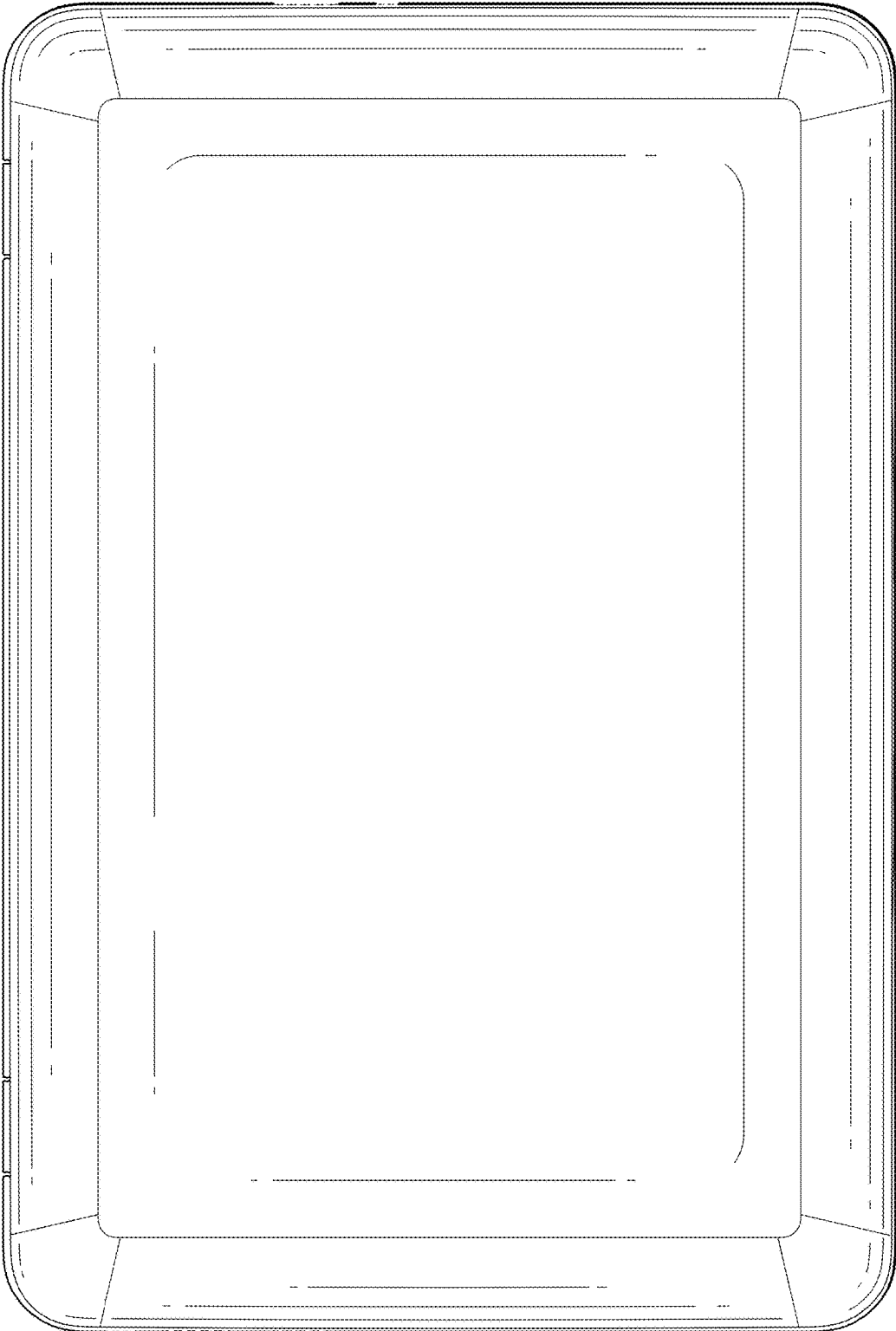

FIG. 6

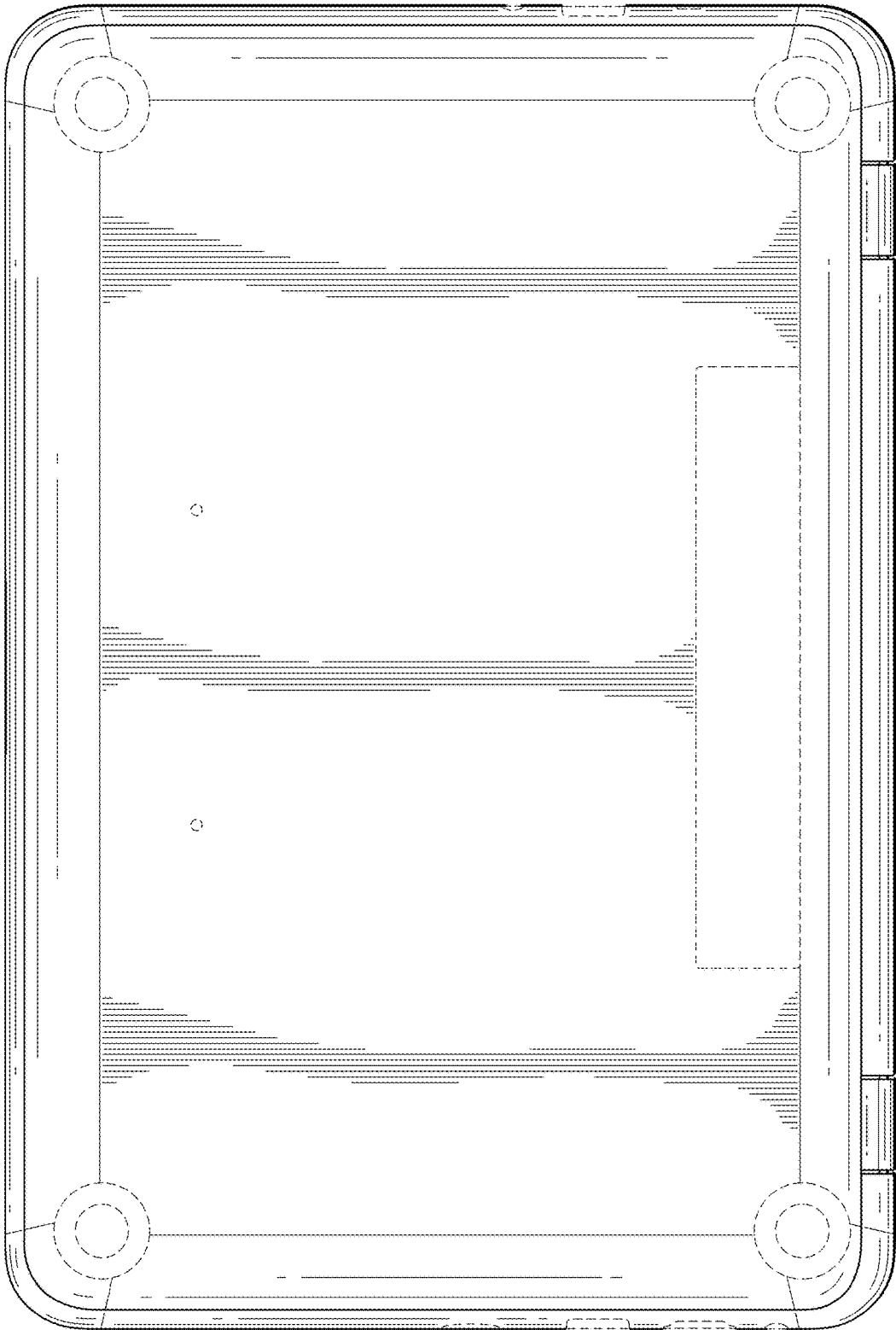

FIG. 7

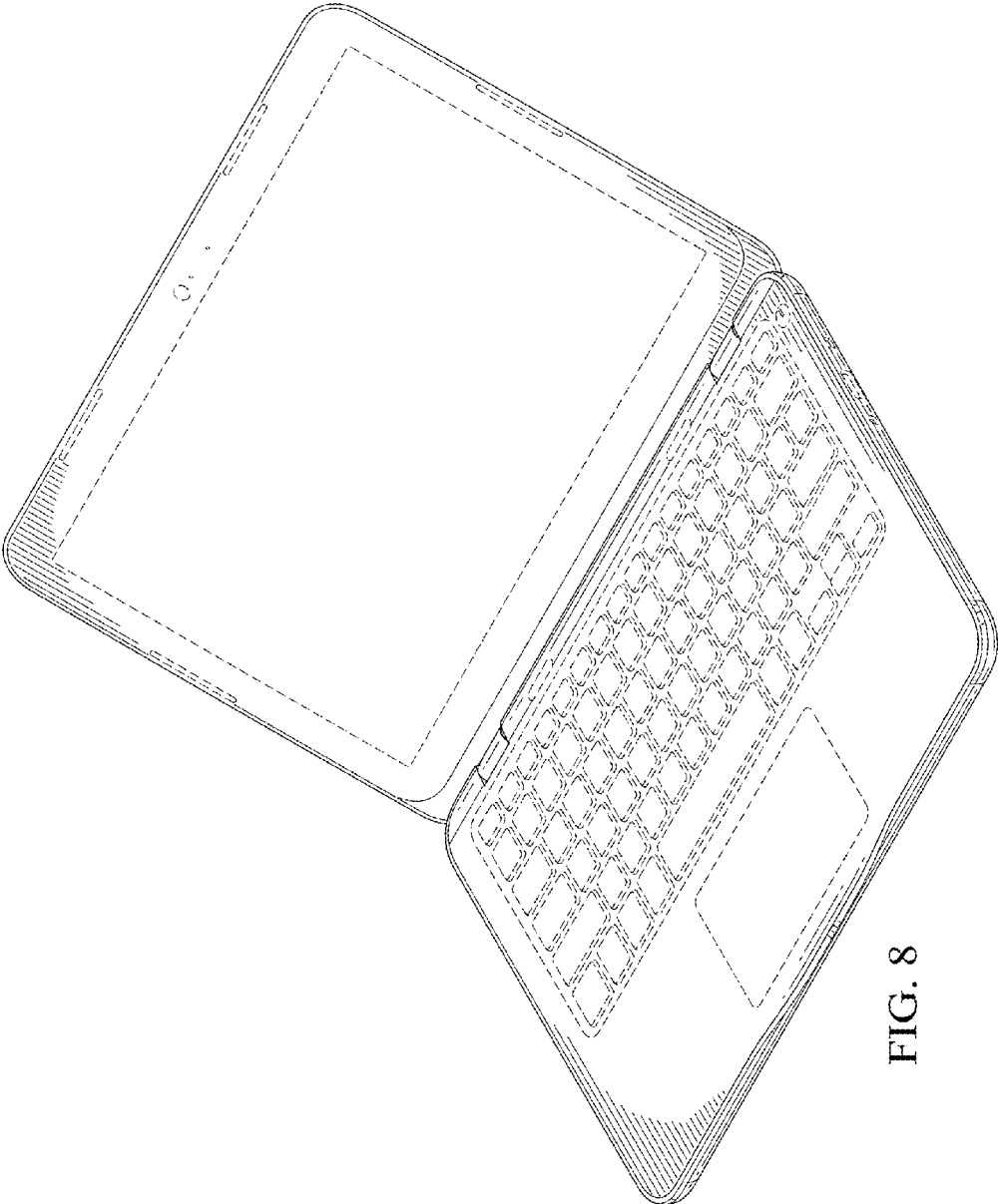

FIG. 8