



US00D567221S

(12) **United States Design Patent**
Liang

(10) **Patent No.:** **US D567,221 S**

(45) **Date of Patent:** **** Apr. 22, 2008**

(54) **IPOD SPEAKER**

D509,223 S * 9/2005 Steele et al. D14/496
D519,487 S * 4/2006 Knight D14/188
D555,147 S * 11/2007 Solland D14/211

(75) Inventor: **Maxine Liang**, ChungHe (TW)

(73) Assignee: **Globe Union Industrial Corp.**,
Taichung (TW)

* cited by examiner

Primary Examiner—Nanda Bondade

(74) *Attorney, Agent, or Firm*—Leong C. Lei

(**) Term: **14 Years**

(21) Appl. No.: **29/277,036**

(57) **CLAIM**

(22) Filed: **Feb. 12, 2007**

The ornamental design for an ipod speaker, as shown and described.

(51) **LOC (8) Cl.** **14-01**

(52) **U.S. Cl.** **D14/207; D14/216**

(58) **Field of Classification Search** D14/204,
D14/207, 209–217, 188–189, 168, 496; 181/143–144,
181/147–148, 150, 157, 198–199, 151, 153;
381/300–302, 306, 333, 345, 361–364, 386–388,
381/332, 336

See application file for complete search history.

DESCRIPTION

FIG. 1 is a perspective view of an ipod speaker showing my new design;

FIG. 2 is a front elevational view thereof;

FIG. 3 is a rear elevational view thereof;

FIG. 4 is a left side elevational view thereof;

FIG. 5 is a right side elevational view thereof;

FIG. 6 is a top plan view thereof; and,

FIG. 7 is a bottom plan view thereof.

(56) **References Cited**

U.S. PATENT DOCUMENTS

D408,035 S * 4/1999 Denham D14/212
D503,395 S * 3/2005 Hirano D14/168

1 Claim, 7 Drawing Sheets

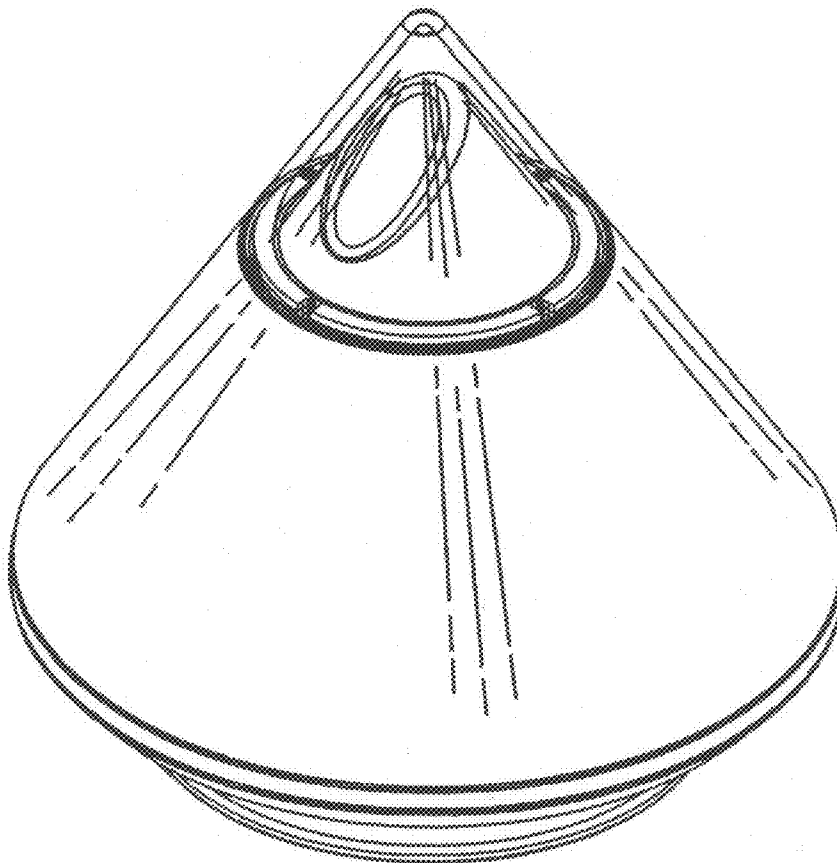

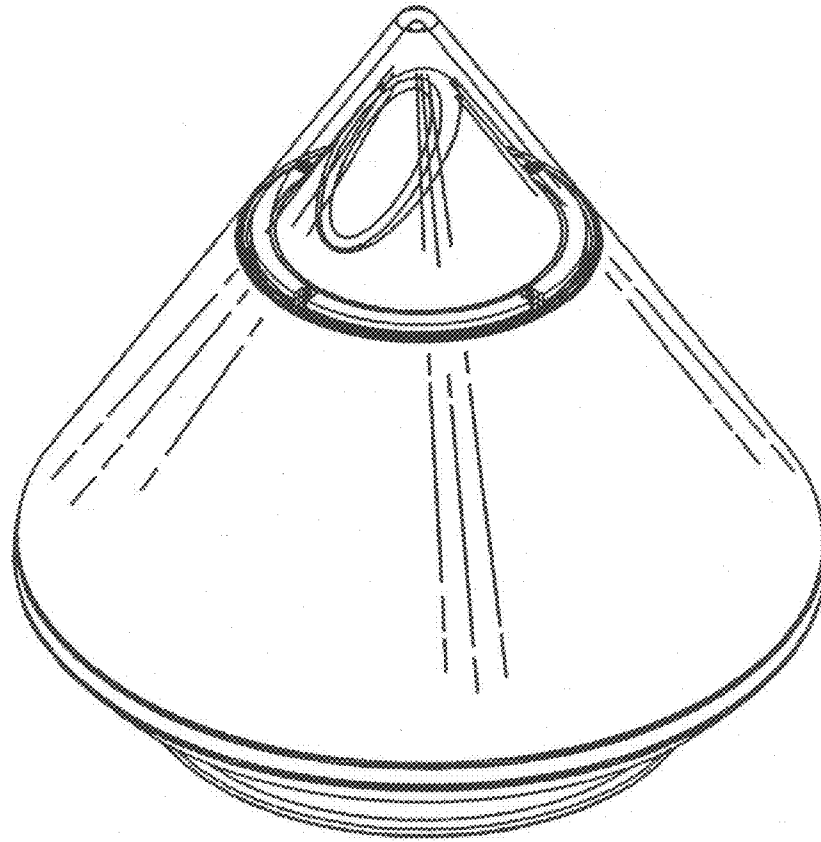

FIG. 1

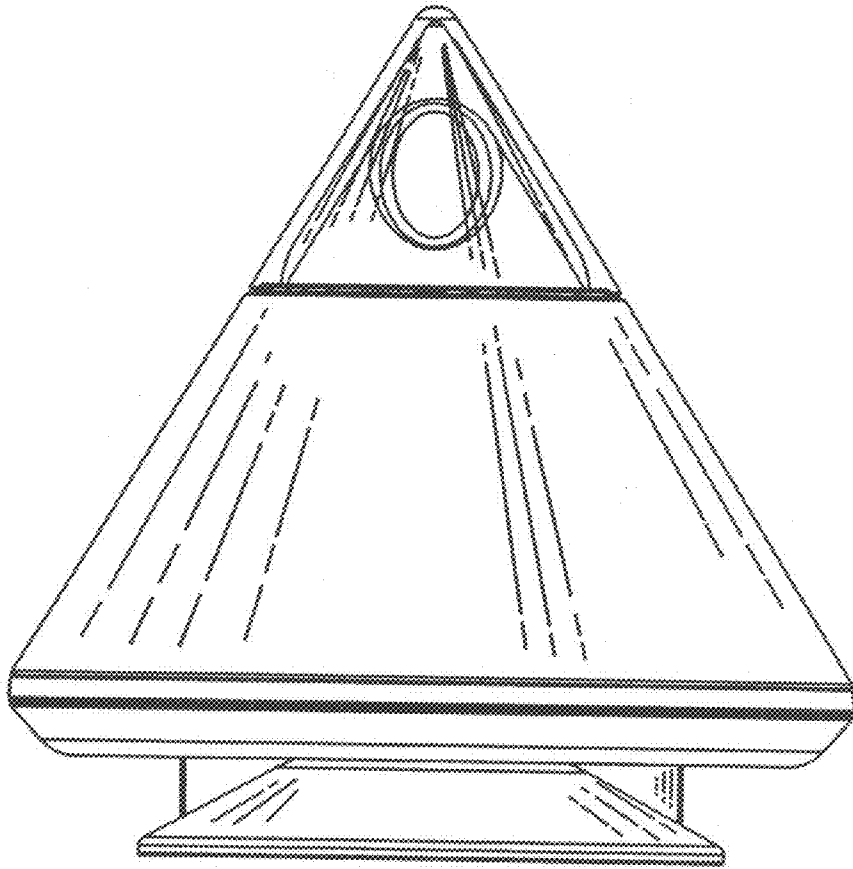

FIG. 2

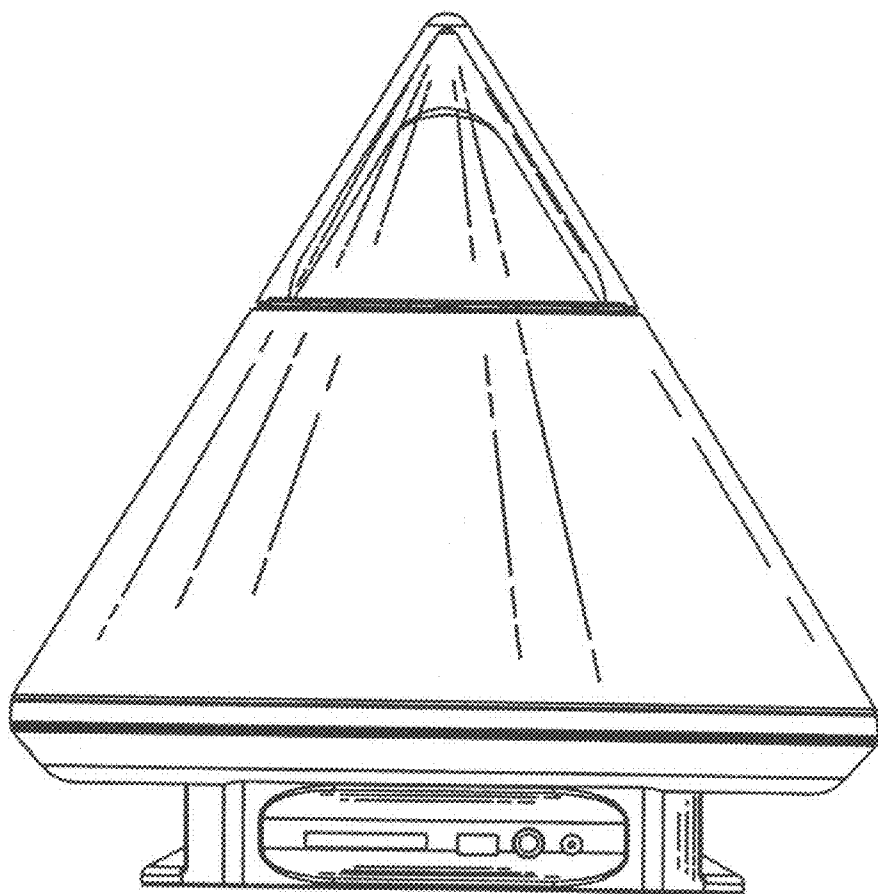

FIG. 3

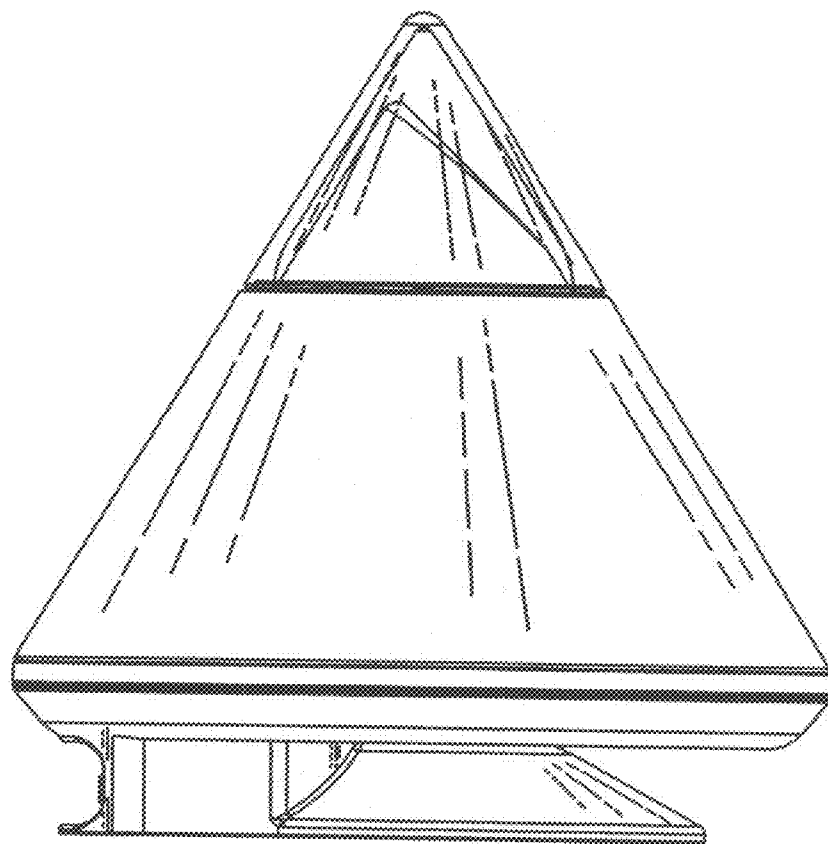

FIG. 4

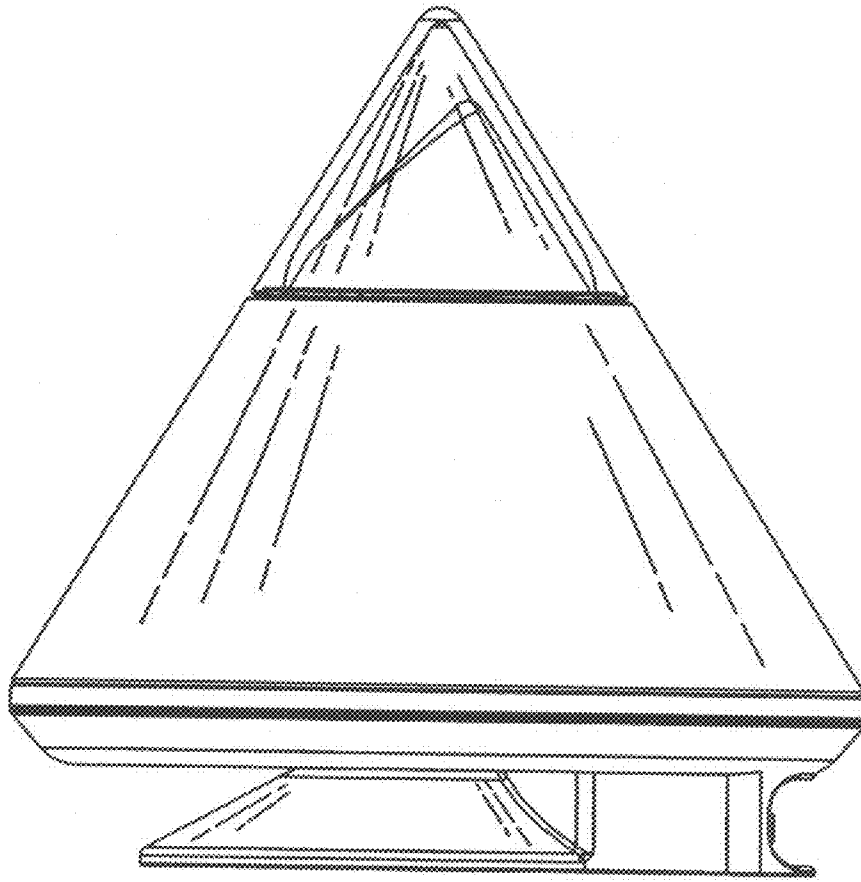

FIG. 5



FIG. 6

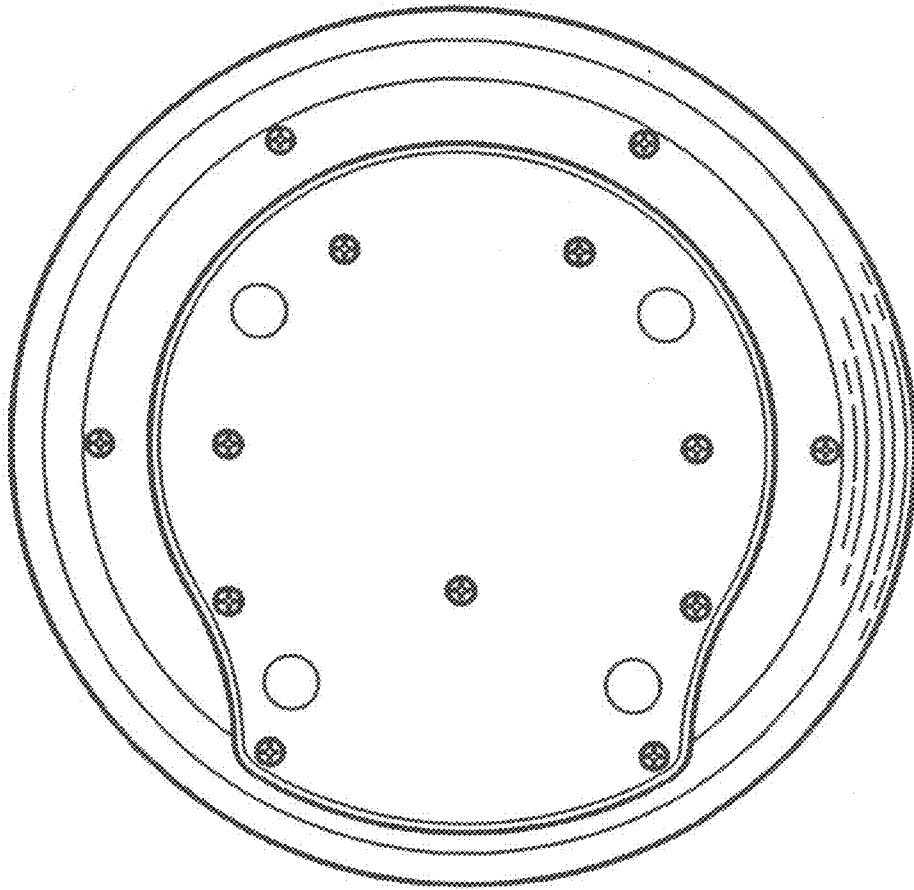

FIG. 7

UNITED STATES PATENT AND TRADEMARK OFFICE
CERTIFICATE OF CORRECTION

PATENT NO. : Des. 567,221 S
APPLICATION NO. : 29/277036
DATED : April 22, 2008
INVENTOR(S) : Maxine Liang

Page 1 of 1

It is certified that error appears in the above-identified patent and that said Letters Patent is hereby corrected as shown below:

Title Page, Item (73) Assignee: should read, CONCEPTMAX CORP.

Signed and Sealed this

Fifth Day of January, 2010

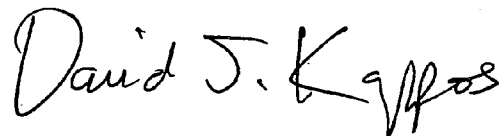
A handwritten signature in black ink that reads "David J. Kappos". The signature is written in a cursive, slightly slanted style.

David J. Kappos
Director of the United States Patent and Trademark Office