



US00D328221S

United States Patent [19]

[11] Patent Number: Des. 328,221

Piccarillo

[45] Date of Patent: ** Jul. 28, 1992

[54] WHEELED COOLER CHEST

4,873,841 10/1989 Bradsaw et al. 62/457.1 X
4,932,677 6/1990 Shustack 62/457.1 X

[76] Inventor: Joseph Piccarillo, 1921 - 80th St.,
Brooklyn, N.Y. 11213

Primary Examiner—Terry A. Pfeffer
Attorney, Agent, or Firm—Terry M. Gernstein

[**] Term: 14 Years

[57] CLAIM

[21] Appl. No.: 527,243

The ornamental design for a wheeled cooler chest, as shown and described.

[22] Filed: May 23, 1990

[52] U.S. Cl. D7/605

[58] Field of Search D7/605-608;
D34/12, 14, 24; 206/541, 545; 62/457.1, 457.2,
457.7

DESCRIPTION

[56] References Cited

U.S. PATENT DOCUMENTS

3,591,194 7/1971 Vaga .
4,319,629 3/1982 Hotta .
4,724,681 2/1988 Bartholomew .

FIG. 1 is a perspective view of a wheeled cooler chest showing my new design;

FIG. 2 is a left side elevational view thereof;

FIG. 3 is a front elevational view thereof;

FIG. 4 is a right side elevational view thereof;

FIG. 5 is a rear elevational view thereof;

FIG. 6 is a top plan view thereof; and,

FIG. 7 is a bottom view thereof.

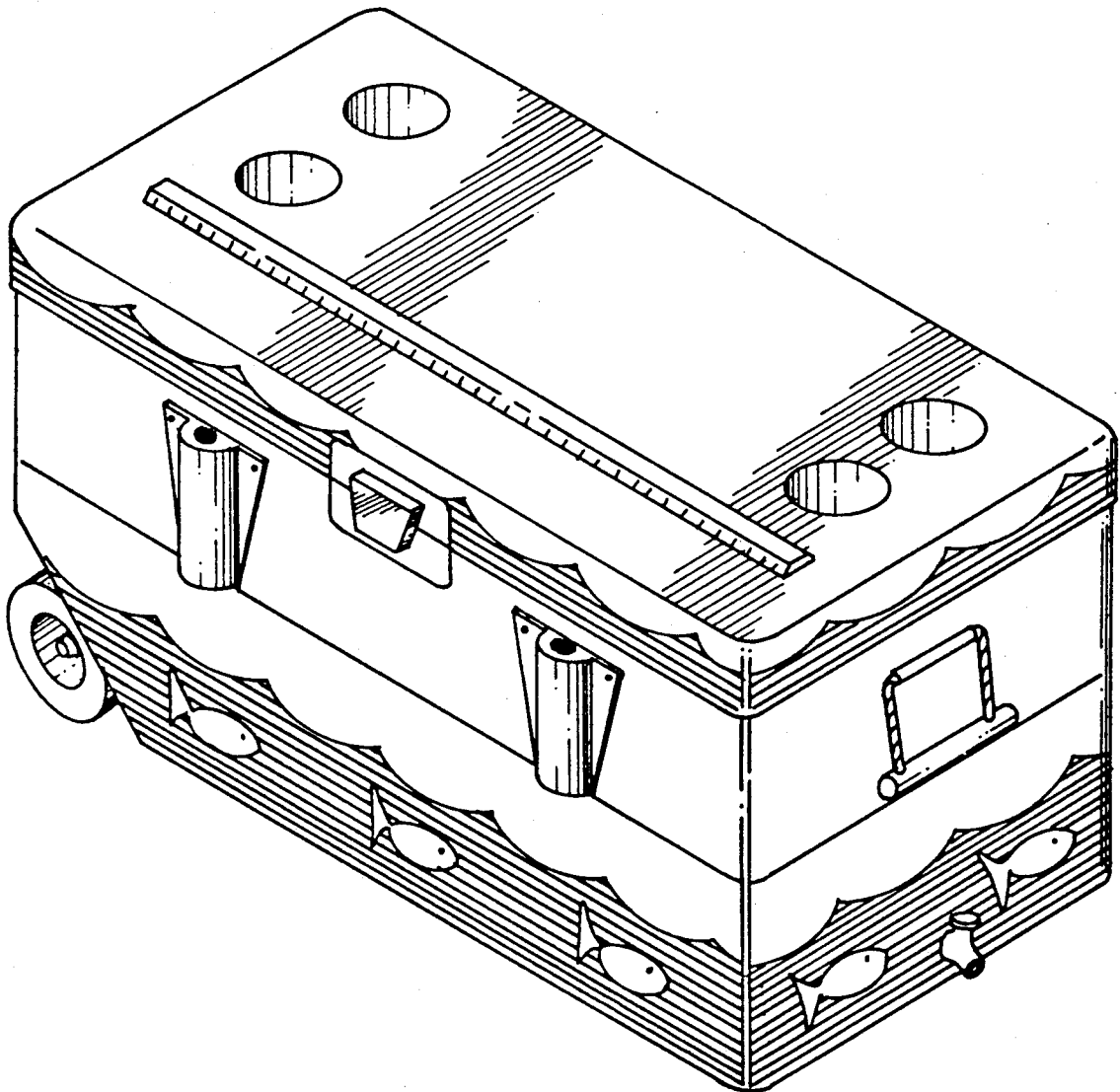

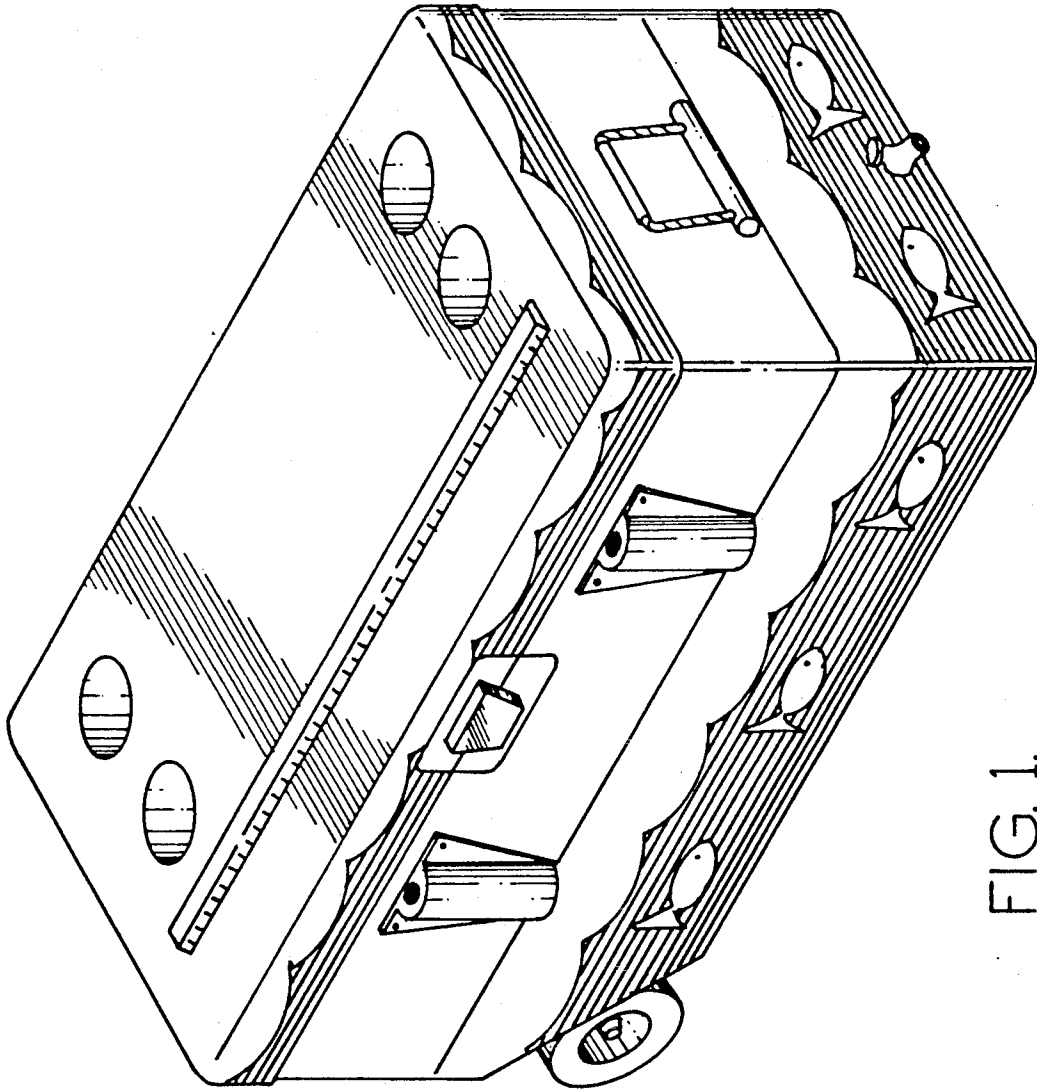

FIG. 1.

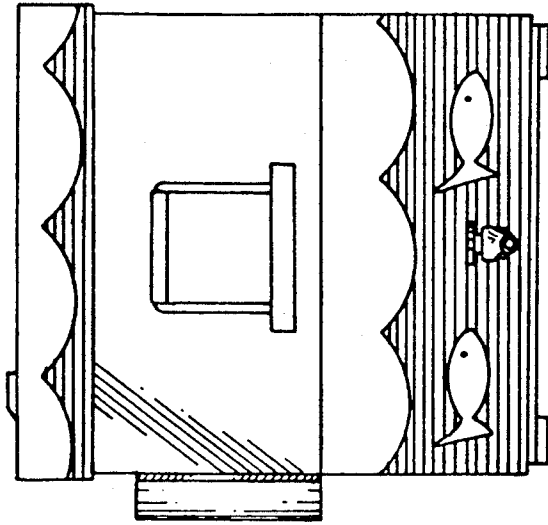

FIG. 3.

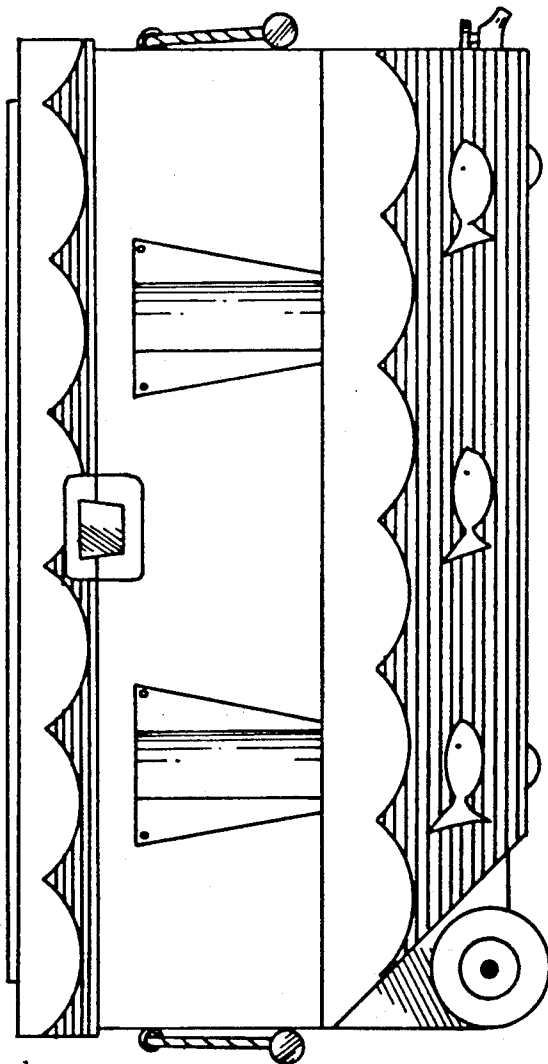

FIG. 2.

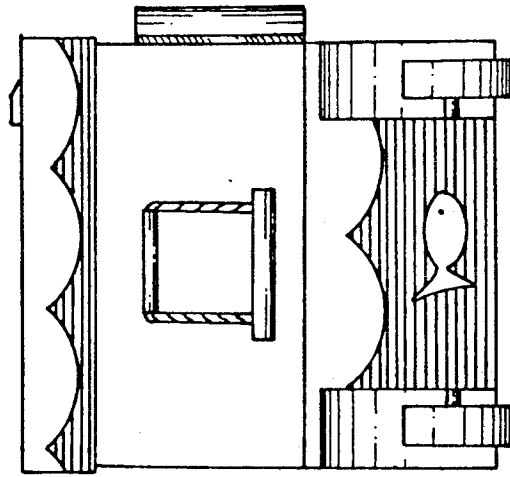

FIG. 5.

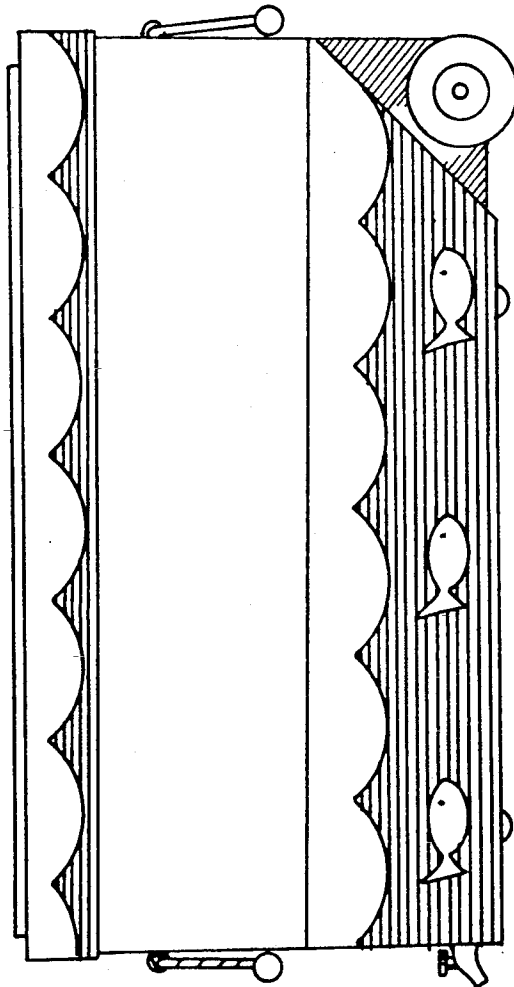

FIG. 4.

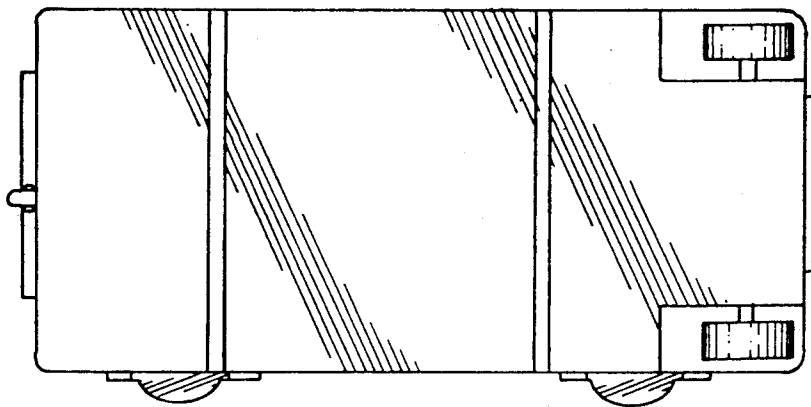

FIG.7.

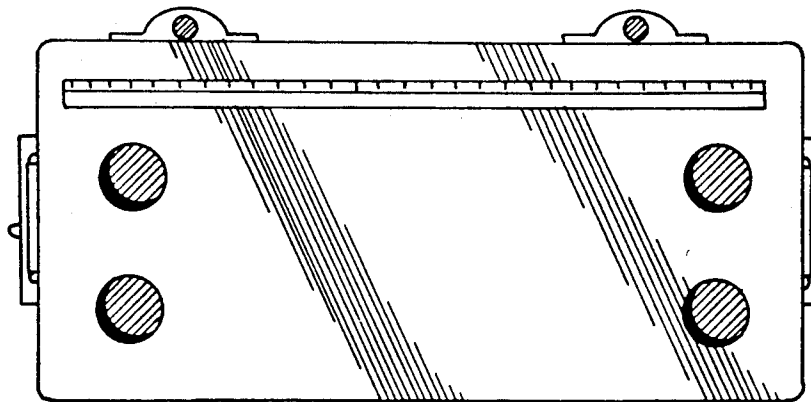

FIG.6.