



US00D590106S

(12) **United States Design Patent**
Nimmons

(10) **Patent No.:** **US D590,106 S**

(45) **Date of Patent:** **** Apr. 7, 2009**

(54) **FACEGUARD**

(75) Inventor: **Kenneth W. Nimmons**, Litchfield, IL (US)

(73) Assignee: **Melas, Inc.**, Litchfield, IL (US)

(**) Term: **14 Years**

(21) Appl. No.: **29/292,936**

(22) Filed: **Oct. 31, 2007**

(51) **LOC (9) Cl.** **29-02**

(52) **U.S. Cl.** **D29/122**

(58) **Field of Classification Search** D29/102-112, D29/122; D24/110.1-110.4, 191; 267/142-146, 267/113, 64.13; 2/410-414, 416, 422-425, 2/9, 10, 206, 427, 429, 5, 6.3, 6.5, 6.7; 128/857-858
See application file for complete search history.

(56) **References Cited**

U.S. PATENT DOCUMENTS

1,522,952 A	1/1925	Goldsmith
1,892,943 A	1/1933	Geyer
2,140,716 A	12/1938	Pryale
2,296,335 A	9/1942	Brady
2,969,546 A	1/1961	Morgan, Jr.
3,166,761 A	1/1965	Strohm
3,186,004 A	6/1965	Carlini
3,263,236 A	8/1966	Humphrey
3,274,613 A	9/1966	Sowle
3,548,409 A	12/1970	Aileo
3,609,764 A	10/1971	Morgan
3,761,959 A	10/1973	Dunning
3,882,547 A	5/1975	Morgan
3,897,598 A	8/1975	Bednarczuk et al.
4,028,743 A	6/1977	Christensen
4,075,714 A	2/1978	Ryder et al.
4,086,664 A	5/1978	Humphrey et al.

(Continued)

OTHER PUBLICATIONS

Face-off Lacrosse Yearbook, 2003, vol. 10, Spring 2003, three pages.

(Continued)

Primary Examiner—Ruth McInroy

(74) *Attorney, Agent, or Firm*—Brinks Hofer Gilson & Lione

(57) **CLAIM**

I claim the ornamental design for a faceguard, as shown and described.

DESCRIPTION

FIG. 1 is a perspective view of a first embodiment of a new design of a faceguard;

FIG. 2 is a front view of the design shown in FIG. 1;

FIG. 3 is a rear view of the design shown in FIG. 1;

FIG. 4 is a right side view of the design shown in FIG. 1;

FIG. 5 is a left side view of the design shown in FIG. 1;

FIG. 6 is a top view of the design shown in FIG. 1;

FIG. 7 is a bottom view of the design shown in FIG. 1;

FIG. 8 is a perspective view of a second embodiment of a new design of a faceguard;

FIG. 9 is a front view of the design shown in FIG. 8;

FIG. 10 is a rear view of the design shown in FIG. 8;

FIG. 11 is a right side view of the design shown in FIG. 8;

FIG. 12 is a left side view of the design shown in FIG. 8;

FIG. 13 is a top view of the design shown in FIG. 8; and,

FIG. 14 is a bottom view of the design shown in FIG. 8.

The ornamental designs which are claimed are shown in solid lines in the drawings. Any broken lines in the drawings are for illustrative purposes only and form no part of the claimed designs.

1 Claim, 8 Drawing Sheets

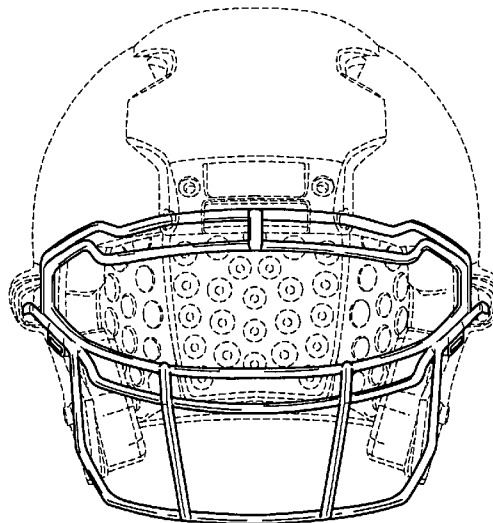
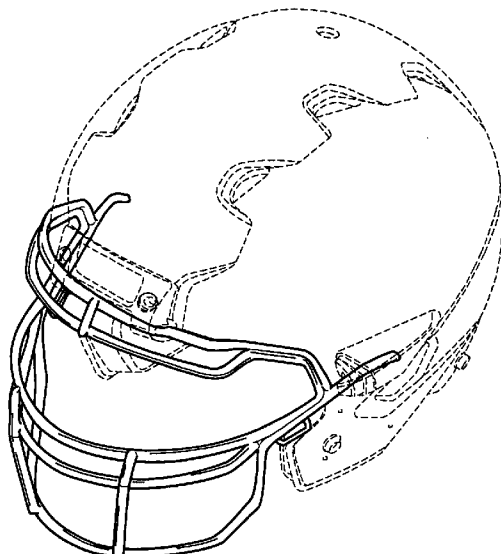

U.S. PATENT DOCUMENTS

D249,397 S * 9/1978 Humphrey et al. D29/111
 4,233,687 A 11/1980 Lancellotti
 4,287,613 A 9/1981 Schulz
 D267,287 S 12/1982 Gooding
 4,363,140 A 12/1982 Correale
 4,370,759 A 2/1983 Zide
 4,390,995 A 7/1983 Walck
 4,404,690 A 9/1983 Farquharson
 4,633,531 A 1/1987 Nimmons
 4,646,368 A 3/1987 Infusino et al.
 D289,568 S * 4/1987 Nimmons D29/111
 D289,569 S * 4/1987 Nimmons D29/111
 4,692,947 A 9/1987 Black et al.
 4,744,107 A 5/1988 Föhl
 D298,868 S * 12/1988 Klindt D29/111
 4,794,652 A 1/1989 Piech von Planta et al.
 4,831,668 A 5/1989 Schulz
 4,837,866 A 6/1989 Rector et al.
 4,853,980 A 8/1989 Zarotti
 4,903,346 A 2/1990 Reddemann et al.
 4,916,759 A 4/1990 Arai
 4,947,490 A 8/1990 Hayden
 5,014,365 A 5/1991 Schulz
 5,035,009 A 7/1991 Wingo, Jr. et al.
 5,142,700 A 8/1992 Reed
 D332,507 S 1/1993 Anderson et al.
 5,175,889 A 1/1993 Infusino
 5,177,816 A 1/1993 Schmidt et al.
 5,263,203 A 11/1993 Kraemer et al.
 5,267,353 A 12/1993 Milligan
 5,293,649 A 3/1994 Corpus
 D350,710 S 9/1994 Keiffer
 D358,686 S * 5/1995 Kraemer D29/111
 D364,487 S 11/1995 Tutton et al.
 D381,127 S * 7/1997 Rothwell D29/111
 D383,953 S 9/1997 DeFilippo
 5,732,414 A 3/1998 Monica

D408,236 S 4/1999 Rennick
 5,963,990 A 10/1999 White
 6,128,786 A 10/2000 Maddux et al.
 6,189,156 B1 2/2001 Loiares
 6,219,850 B1 4/2001 Halstead et al.
 6,226,801 B1 5/2001 Alexander et al.
 6,370,699 B1 4/2002 Halstead et al.
 D459,032 S 6/2002 Gatellet
 D459,554 S 6/2002 Gatellet
 6,438,762 B1 8/2002 Jenkins
 D463,885 S * 10/2002 Burns D29/111
 D465,067 S 10/2002 Ide et al.
 6,481,024 B1 11/2002 Grant
 D466,651 S 12/2002 Halstead et al.
 D475,486 S 6/2003 Ide et al.
 D508,298 S * 8/2005 Bernacchi et al. D29/111
 6,934,971 B2 8/2005 Ide et al.
 D517,250 S * 3/2006 Polstein D29/122
 7,036,151 B2 5/2006 Ide et al.
 D528,705 S 9/2006 Ida et al.
 7,146,652 B2 12/2006 Ide et al.
 7,240,376 B2 7/2007 Ide et al.
 2002/0104533 A1 8/2002 Kalhok et al.
 2007/0192944 A1 8/2007 Ide et al.

OTHER PUBLICATIONS

Photographs of four (4) helmets, labeled A1-A6, B1-B5, C1-C7, D1-D5, E1-E3, and F1-F5, eighteen pages, Atty Morgan verified date: Apr. 20, 2005.
 U.S. Appl. No. 11/981,171, filed Oct. 31, 2007, Nimmons et al.
 U.S. Appl. No. 29/292,931, filed Oct. 31, 2007, Nimmons.
 U.S. Appl. No. 29/292,922, filed Oct. 31, 2007, Nimmons.
 U.S. Appl. No. 29/294,838, filed Jan. 29, 2008, Nimmons et al.
 U.S. Appl. No. 29/294,839, filed Jan. 29, 2008, Nimmons et al.
 U.S. Appl. No. 29/294,848, filed Jan. 29, 2008, Nimmons et al.
 U.S. Appl. No. 29/294,857, filed Jan. 29, 2008, Nimmons et al.

* cited by examiner

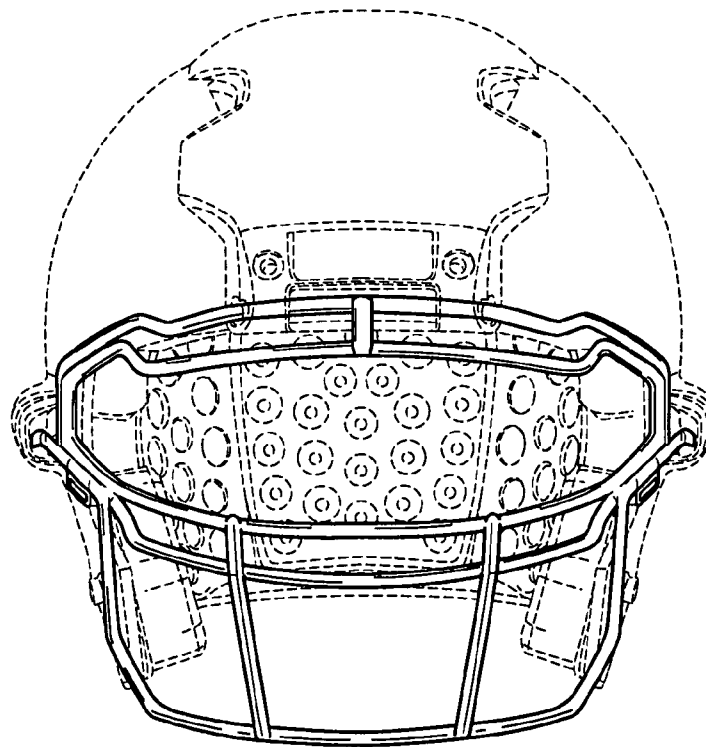
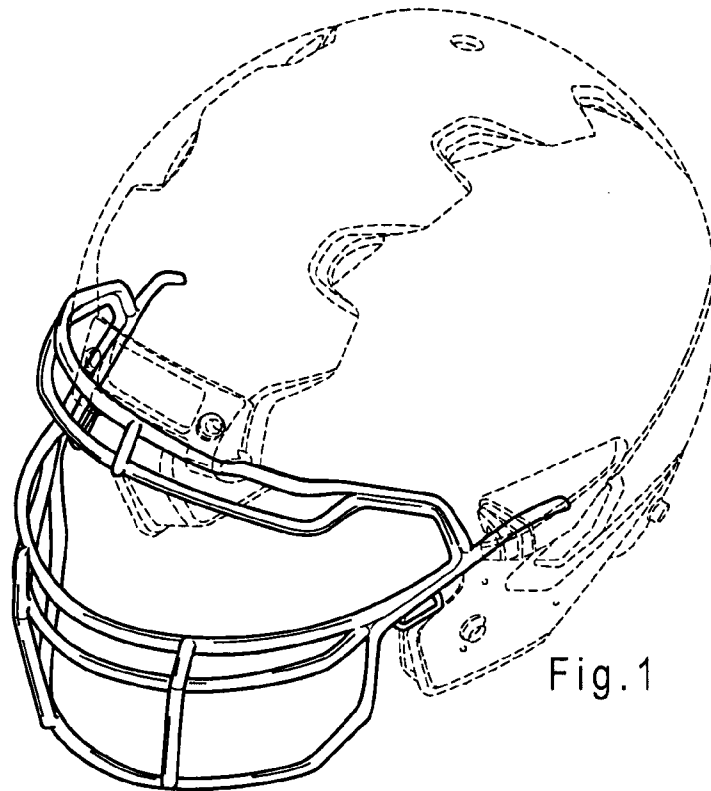

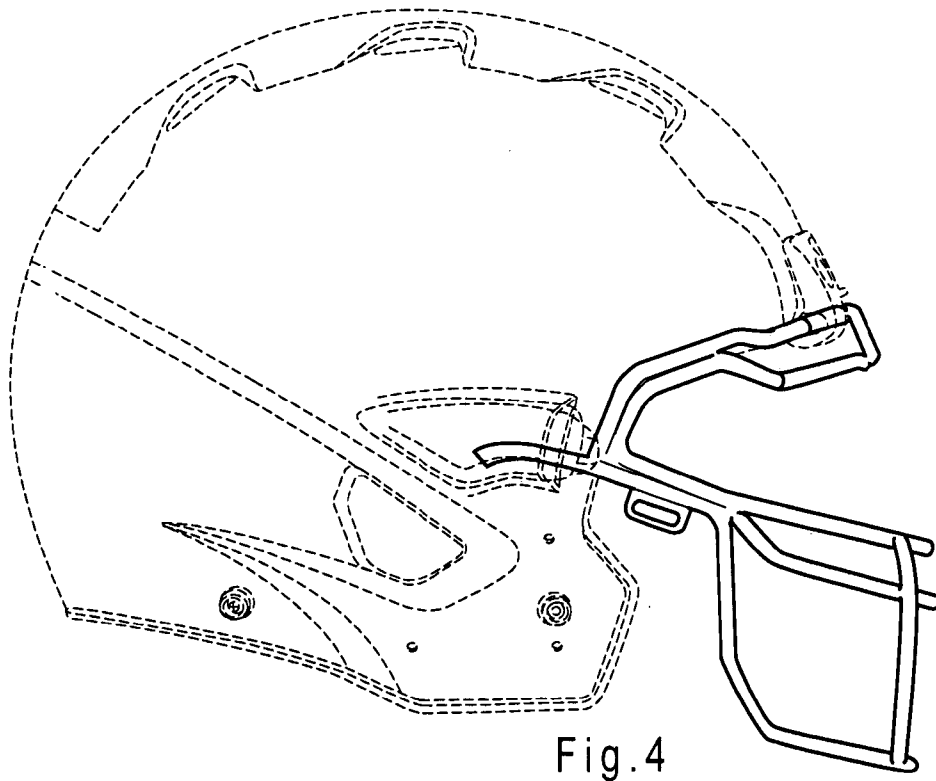
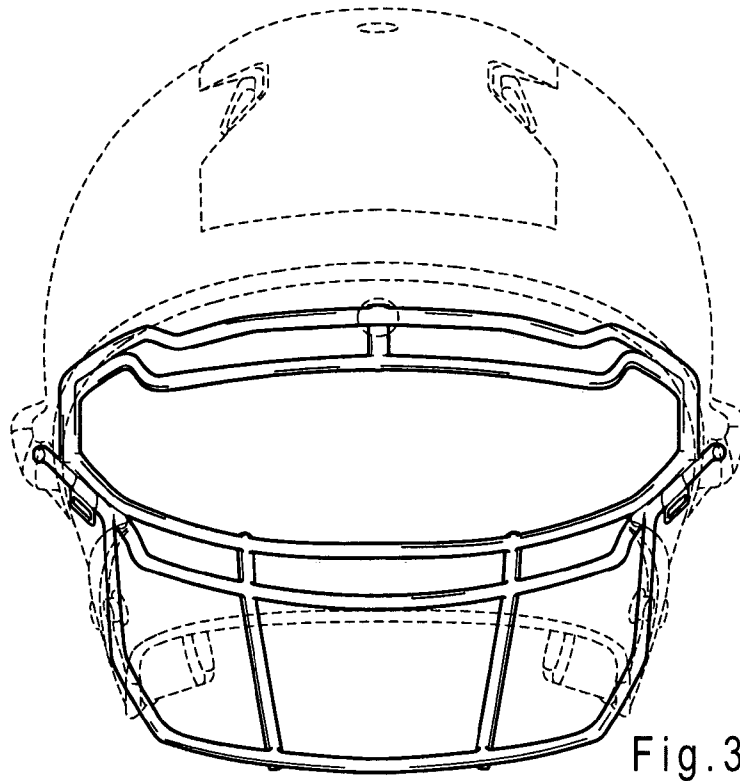

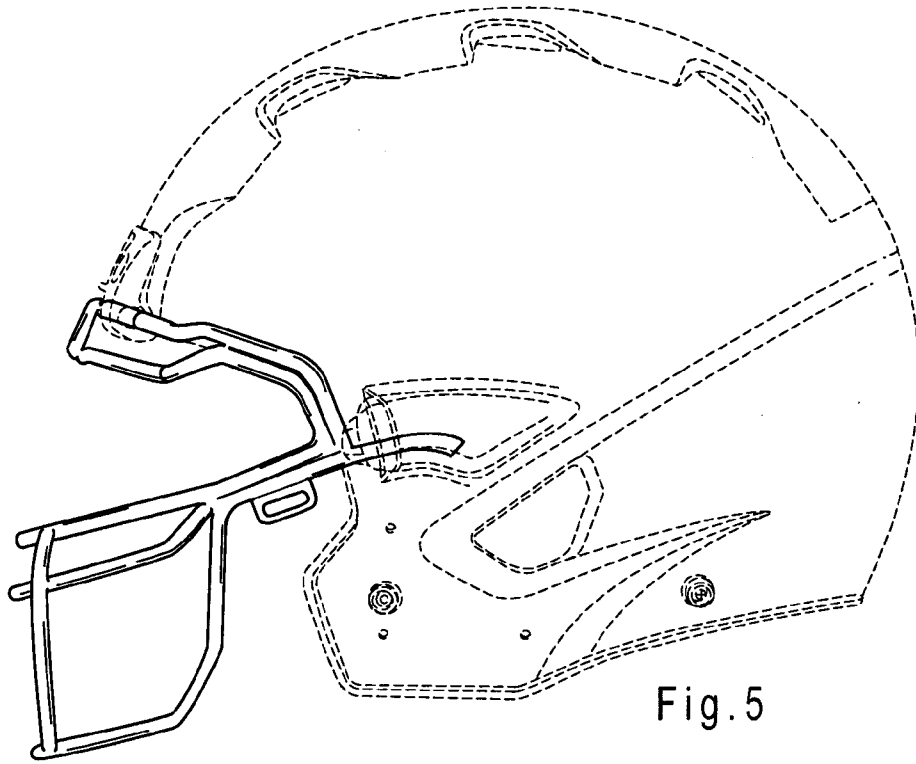

Fig. 5

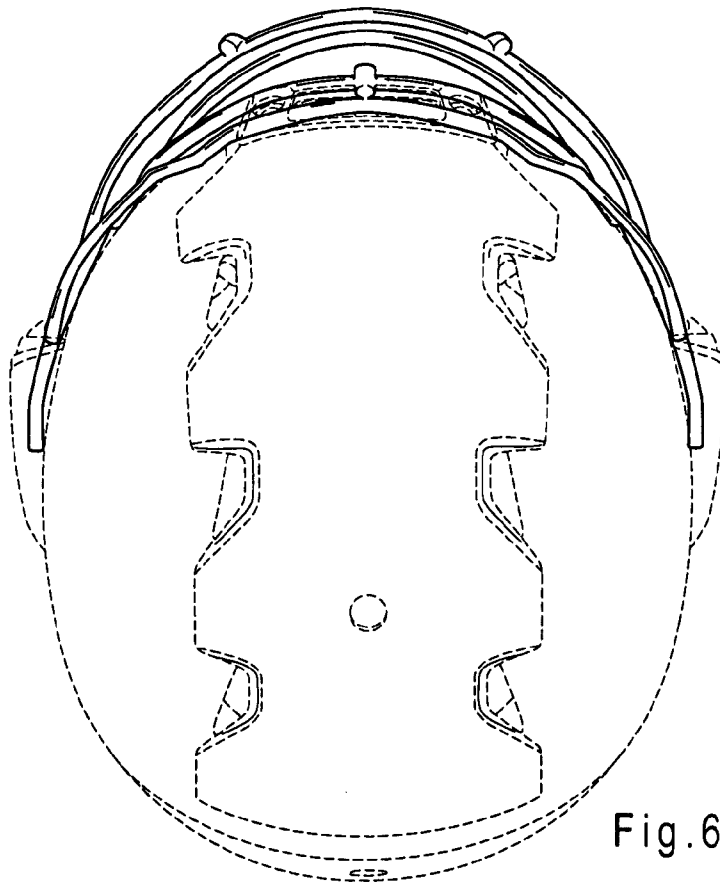

Fig. 6

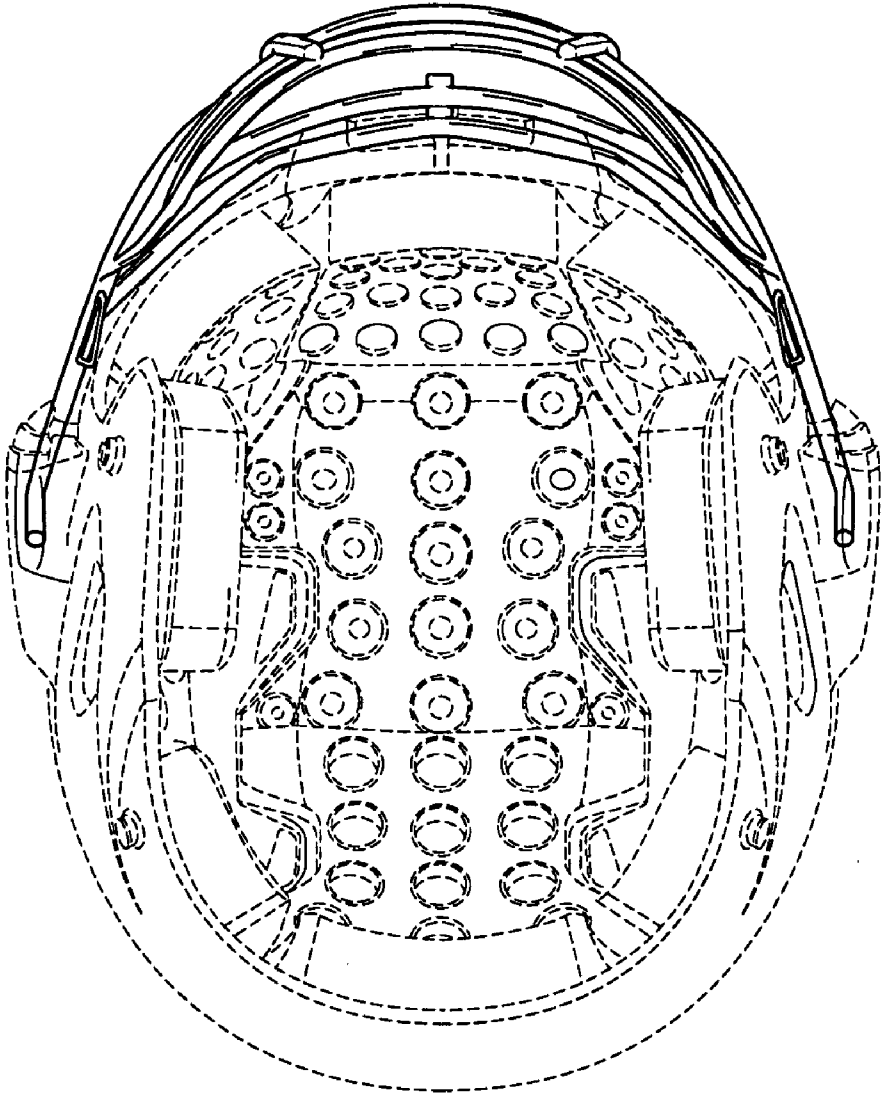

Fig. 7

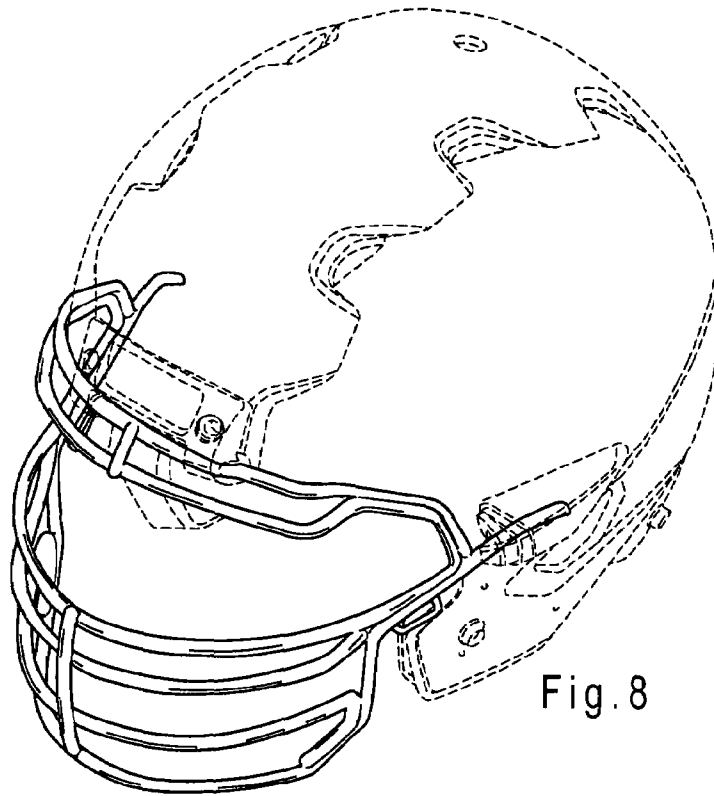

Fig. 8

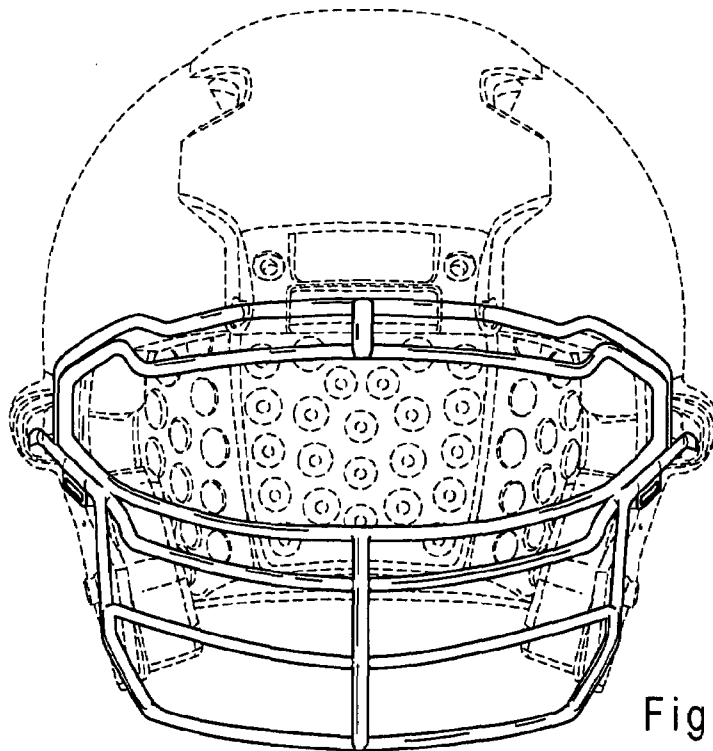

Fig. 9

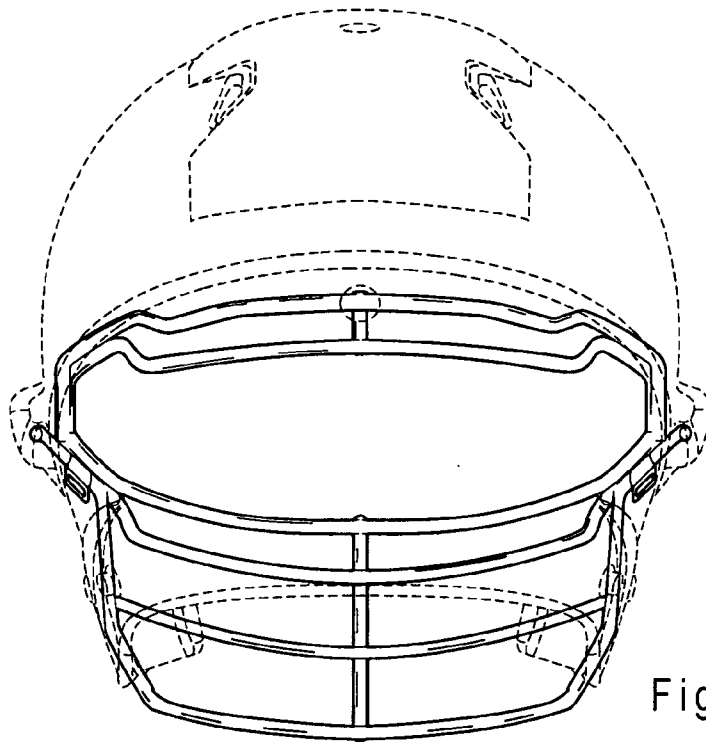

Fig.10

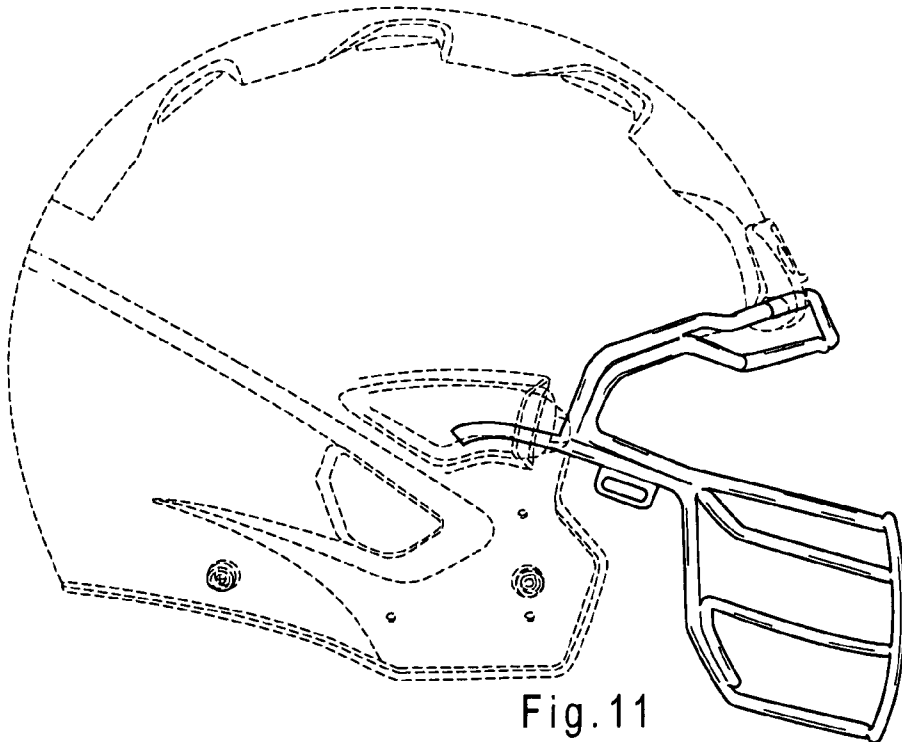

Fig.11

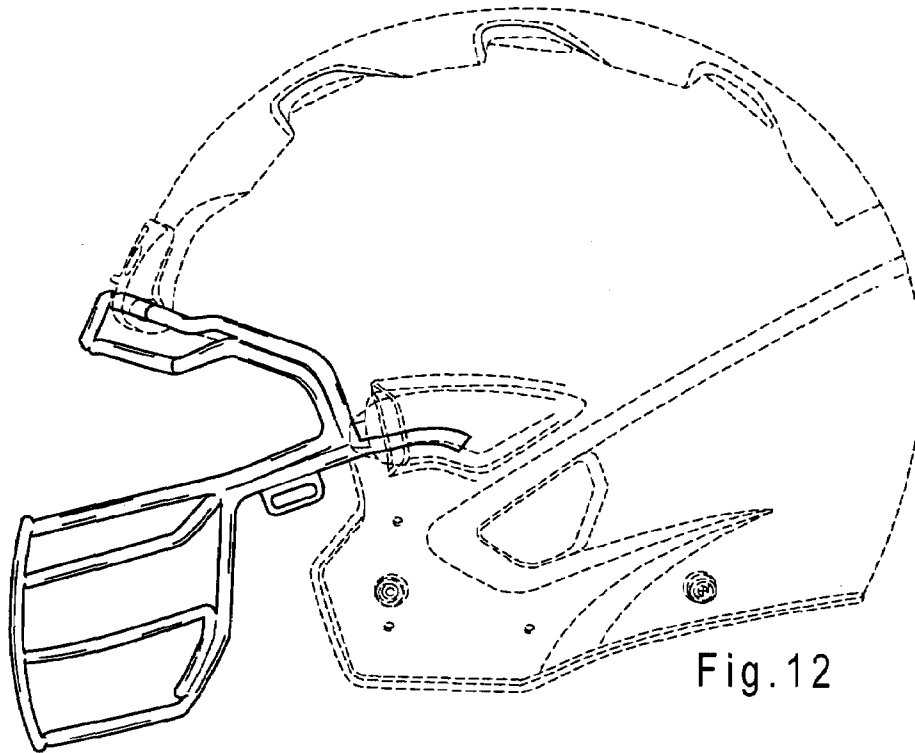

Fig. 12

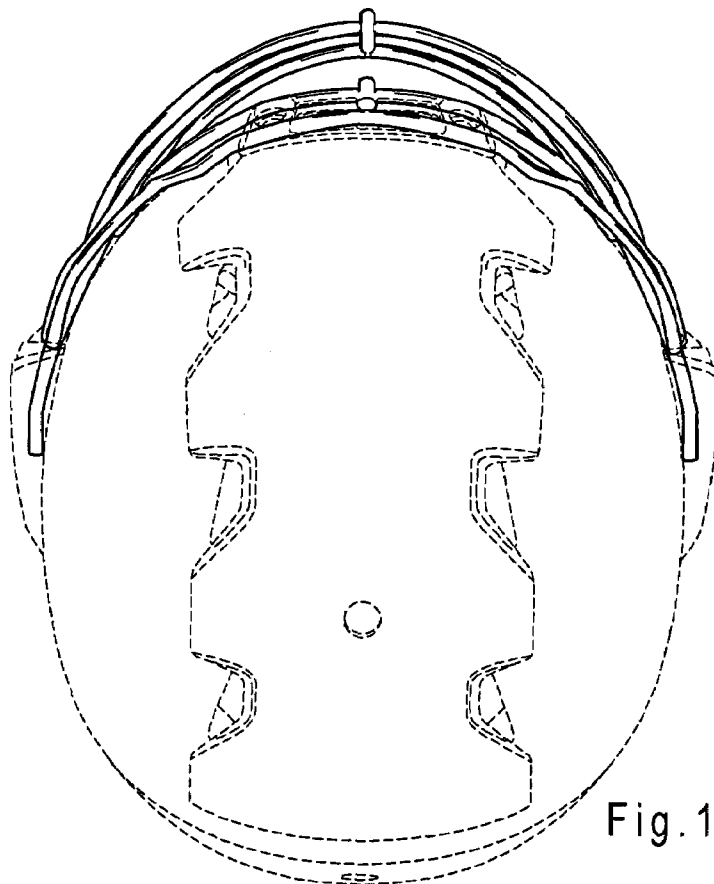

Fig. 13

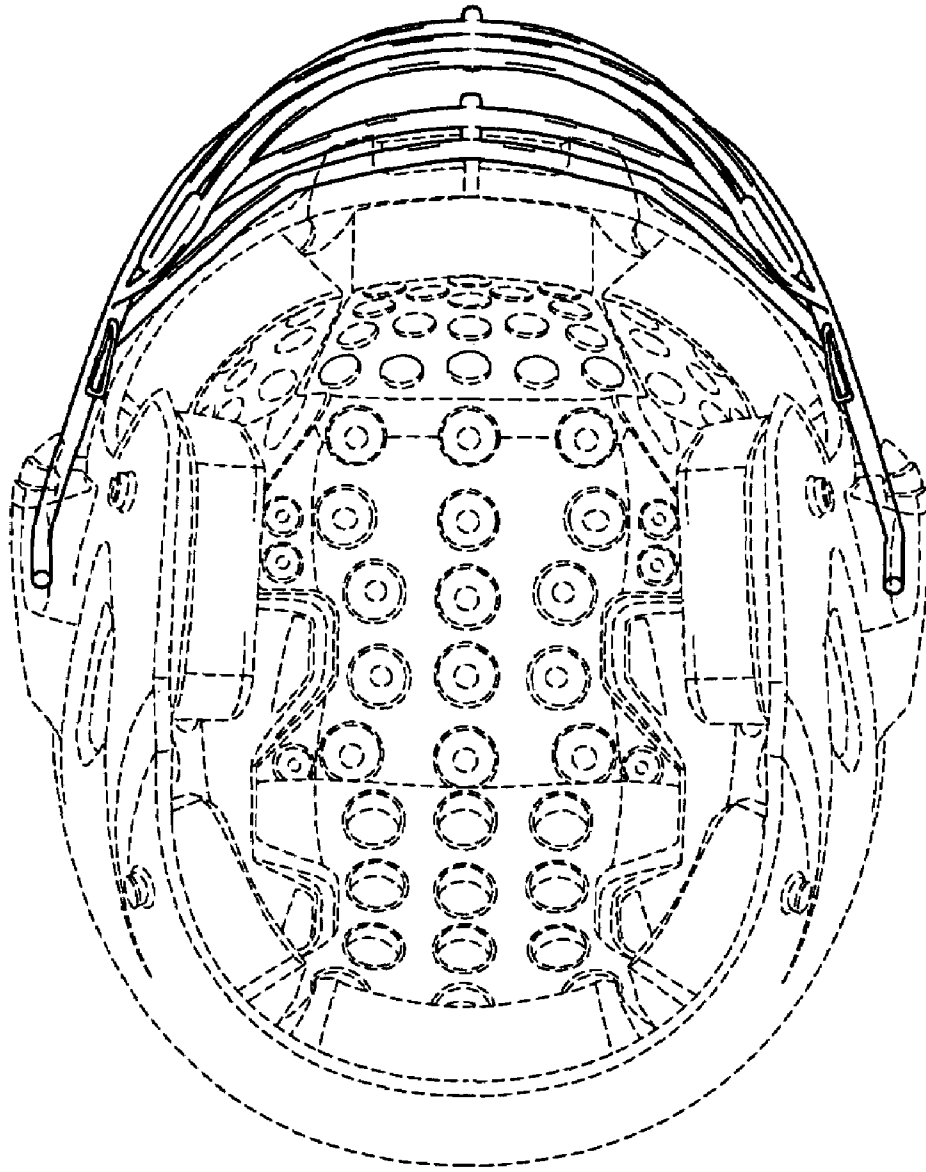

Fig. 14