

(19) World Intellectual Property Organization  
International Bureau



(43) International Publication Date  
20 November 2008 (20.11.2008)

PCT

(10) International Publication Number  
**WO 2008/140990 A1**

- (51) International Patent Classification:  
*G02C 7/10* (2006.01)
- (21) International Application Number:  
PCT/US2008/062691
- (22) International Filing Date: 5 May 2008 (05.05.2008)
- (25) Filing Language: English
- (26) Publication Language: English
- (30) Priority Data:  
11/746,017 8 May 2007 (08.05.2007) US
- (71) Applicant (for all designated States except US): **GUNNAR OPTIKS, LLC** [US/US]; 12626 High Bluff Drive, Suite 440, San Diego, CA 92130 (US).
- (72) Inventors; and
- (75) Inventors/Applicants (for US only): **CROFT, Joe** [US/US]; 3501 Tres Rios, San Clemente, CA 92673 (US). **MICHELSON, Matthew** [US/US]; 16724 Calle Hermosa, San Diego, CA 92127 (US). **JOYCE, Robert** [US/US]; 965 Idyllwild Way, San Marcos, CA 92078 (US).
- (74) Agent: **ALTMAN, Daniel, E.**; Knobbe, Martens, Olson & Bear, LLP, 2040 Main Street, 14th Floor, Irvine, CA 92614 (US).
- (81) Designated States (unless otherwise indicated, for every kind of national protection available): AE, AG, AL, AM, AO, AT, AU, AZ, BA, BB, BG, BH, BR, BW, BY, BZ, CA, CH, CN, CO, CR, CU, CZ, DE, DK, DM, DO, DZ, EC, EE, EG, ES, FI, GB, GD, GE, GH, GM, GT, HN, HR, HU, ID, IL, IN, IS, JP, KE, KG, KM, KN, KP, KR, KZ, LA, LC, LK, LR, LS, LT, LU, LY, MA, MD, ME, MG, MK, MN, MW, MX, MY, MZ, NA, NG, NI, NO, NZ, OM, PG, PH, PL, PT, RO, RS, RU, SC, SD, SE, SG, SK, SL, SM, SV, SY, TJ, TM, TN, TR, TT, TZ, UA, UG, US, UZ, VC, VN, ZA, ZM, ZW.
- (84) Designated States (unless otherwise indicated, for every kind of regional protection available): ARIPO (BW, GH, GM, KE, LS, MW, MZ, NA, SD, SL, SZ, TZ, UG, ZM, ZW), Eurasian (AM, AZ, BY, KG, KZ, MD, RU, TJ, TM), European (AT, BE, BG, CH, CY, CZ, DE, DK, EE, ES, FI, FR, GB, GR, HR, HU, IE, IS, IT, LT, LU, LV, MC, MT, NL,

[Continued on next page]

(54) Title: EYEWEAR FOR REDUCING SYMPTOMS OF COMPUTER VISION SYNDROME

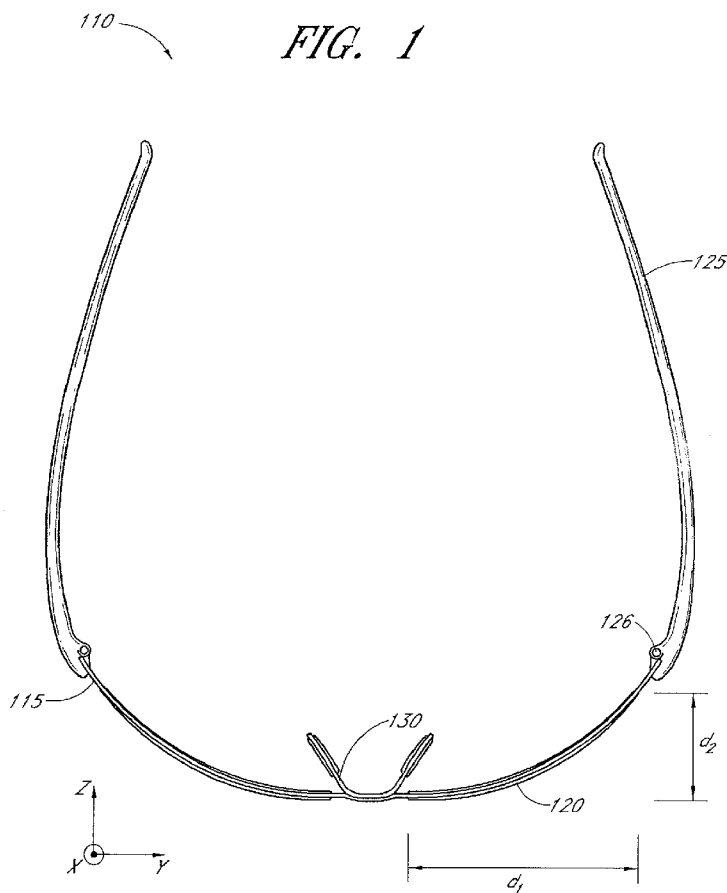

(57) Abstract: Computer eyewear (110) for reducing the effects of Computer Vision Syndrome (CVS). In one embodiment, the eyewear (110) comprises a frame (115) and two lenses (120). In some embodiments, the frame (115) and lenses (120) have a wrap-around design to reduce air flow in the vicinity of the eyes. The lenses can have optical power in the range of approximately +.5 to +2.5 diopters for reducing accommodation demands on a user's eyes when using a computer. The lenses (120) can also include prismatic power for reducing convergence demand on a user's eyes when sitting at a computer. The lenses (120) can also include a partially transmissive mirror coating, tinting, and anti-reflective coatings (e.g., 800, 900, 1000, 1100). In one embodiment, a partially transmissive mirror coating or tinting spectrally filters light to remove spectral peaks (720) in fluorescent or incandescent lighting.

WO 2008/140990 A1



NO, PL, PT, RO, SE, SI, SK, TR), OAPI (BF, BJ, CF, CG,  
CI, CM, GA, GN, GQ, GW, ML, MR, NE, SN, TD, TG).

— *before the expiration of the time limit for amending the  
claims and to be republished in the event of receipt of  
amendments*

**Published:**

— *with international search report*

## EYEWEAR FOR REDUCING SYMPTOMS OF COMPUTER VISION SYNDROME

### BACKGROUND OF THE INVENTION

#### Field of the Invention

[0001] The field of the invention relates to eyewear, and more particularly to eyewear for enhancing a user's experience when viewing a computer screen, or other near object, for extended periods of time.

#### Description of the Related Art

[0002] Computer Vision Syndrome (CVS) is a condition which can result from focusing the eyes on a computer display for protracted periods of time. Common symptoms of CVS are blurred vision, headaches, musculoskeletal pain and fatigue, eye strain, dry eyes, difficulty in focusing the eyes at various distances, double vision, and light sensitivity. Due in part to the prevalence of extended computer usage in many vocations, CVS is a problem that does now, or may in the future, afflict millions of individuals.

### SUMMARY OF THE INVENTION

[0003] Various embodiments of eyewear for viewing a near object, such as a computer screen, for extended periods of time are described herein.

[0004] In some embodiments stock computer eyewear is disclosed, the stock computer eyewear comprising: first and second lens portions each having optical power in the range between about +0.5 to +2.5 diopters, said first and second lens portions having substantially identical optical power to provide off-the-shelf correction for a user having substantially normal uncorrected or spectacle vision when viewing a computer screen, each lens portion having a base curve and an ocular curve; and a frame portion disposed about said first and second lens portions to provide support, wherein said base curve of said first and second lens portions includes a partially transmissive mirror coating thereon.

[0005] In some embodiments a method of mitigating symptoms of computer vision syndrome when viewing a computer screen is disclosed, said method comprising: disposing first and second lens portions in front of eyes having substantially normal uncorrected or spectacle vision, each lens portion having substantially identical optical power in the range between about +0.5 to +2.5 diopters, each lens portion having a partially

transmissive mirror coating thereon; and viewing said computer screen through said first and second lens portions.

[0006] In some embodiments a kit for mitigating symptoms of computer vision syndrome when viewing a computer screen is disclosed, said kit comprising: eyewear comprising first and second non-progressive lens portions, each lens portion having substantially identical optical power in the range between about +0.5 to +2.5 diopters, each lens portion having a partially transmissive mirror coating thereon; and information directing a user to wear said eyewear when viewing a computer screen.

[0007] In some embodiments a kit is disclosed, said kit comprising: a package of three or more pairs of computer eyeglasses, said computer eyeglasses comprising, first and second lens portions each having optical power in the range between about +0.5 to +2.5 diopters, said first and second lens portions having substantially identical optical power to provide non-prescription correction for viewing a computer screen; and a frame portion disposed about said first and second lens portions to provide support, wherein said first and second lens portions include a partially reflective mirror coating thereon.

[0008] In some embodiments a method of mass manufacturing computer eyewear is disclosed, said method comprising: without knowing the prescription of a user, producing a plurality of eyewear, each of said eyewear produced by combining left and right lens portions having optical power in the range between about +0.5 to +2.5 diopters, said left and right lens portions having substantially identical optical power to provide non-prescription correction for left or right eyes for viewing a computer screen, wherein said left and right lens portions have a partially transmissive mirror coating.

[0009] In some embodiments computer eyewear is disclosed, said computer eyewear comprising: first and second lens portions with substantially equal optical power in the range between about +0.5 to +2.5 diopters, said first and second lens portions having substantially identical optical power to provide non-prescription correction for viewing a computer screen; and a frame portion disposed about said first and second lens portions to provide support, wherein said first and second lens portions include an optical filter having at least one stop band in the visible spectrum that coincides with a spectral peak in the emission

of incandescent or fluorescent lighting such that transmission of said spectral peak through said filter is selectively attenuated.

[0010] In some embodiments a method of mass manufacturing computer eyewear is disclosed, said method comprising: without knowing the prescription of a user, producing first and second lens portions with substantially equal optical power in the range between about +0.5 to +2.5 diopters, said first and second lens portions having substantially identical optical power to provide non-prescription correction for viewing a computer screen, wherein said lens portions include a spectral optical filter having at least one stop band in the visible spectrum that coincides with a spectral peak in the emission of incandescent or fluorescent lighting such that transmission of said spectral peak through said filter is selectively attenuated.

[0011] In some embodiments a method of mitigating symptoms of computer vision syndrome when viewing a computer screen is disclosed, said method comprising: disposing first and second lens portions in front of eyes having substantially normal uncorrected or spectacle vision, each lens portion having substantially identical optical power in the range between about +0.5 to +2.5 diopters, each lens portion having a partially transmissive mirror coating thereon, said mirror coating comprising a spectral optical filter having at least one stop band in the visible spectrum that coincides with a spectral peak in the emission of incandescent or fluorescent lighting such that transmission of said spectral peak through said mirror coating is selectively attenuated; and viewing said computer screen through said first and second lens portions.

[0012] In some embodiments computer eyewear is disclosed, said computer eyewear comprising: first and second lens portions each having optical power in the range between about +0.5 to +2.5 diopters, said first and second lens portions having substantially identical optical power to provide non-prescription correction for viewing a computer screen; a frame portion disposed about said first and second lens portions to provide support; and a plurality of side-shields which are removably attached to said eyewear and are configured to at least partially block light and air flow.

[0013] In some embodiments a kit is disclosed, said kit comprising: computer eyewear comprising, first and second lens portions each having optical power in the range

between about +0.5 to +2.5 diopters, said first and second lens portions having substantially identical optical power to provide non-prescription correction for viewing a computer screen, and a frame portion disposed about said first and second lens portions to provide support; and a plurality of side-shields which are detachable from the eyewear and are configured to block light and air flow.

**[0014]** In some embodiments non-prescription computer eyewear is disclosed, said non-prescription computer eyewear comprising: first and second lens portions having optical power in the range between about +0.5 to +2.5 diopters, said first and second lens portions having substantially identical optical power to provide off-the-shelf correction for a user having substantially normal uncorrected or spectacle vision when viewing a computer screen, each lens portion having a peripheral region and a central region; and a frame portion disposed about said first and second lens portions to provide support, wherein said first and second lens portions have a transmissivity that varies smoothly from said peripheral regions to said central regions.

**[0015]** In some embodiments non-prescription computer eyewear is disclosed, said non-prescription computer eyewear comprising: first and second lenses having optical power in the range between about +0.5 to +2.5 diopters, said first and second lenses having substantially identical optical power to provide non-prescription correction for viewing a computer screen; and a frame portion disposed about said first and second lenses to provide support, wherein said first and second lenses include light absorbing tinting, the absorptivity of which substantially varies, said tinting covering at least 90% of said lenses.

**[0016]** In some embodiments non-prescription computer eyewear is disclosed, said non-prescription computer eyewear comprising: first and second lenses having optical power in the range between about +0.5 to +2.5 diopters, said first and second lenses having substantially identical optical power to provide off-the-shelf correction for a user having substantially normal uncorrected or spectacle vision when viewing a computer screen; and a frame portion disposed about said first and second lenses to provide support, wherein said first and second lenses include light absorbing tinting, the absorptivity of which varies between a non-zero baseline lower level and an upper level.

[0017] In some embodiments stock computer eyewear is disclosed, said stock computer eyewear comprising: a first lens having a first geometric center and a first optical center offset from the first geometric center; and a second lens having a second geometric center and a second optical center offset from the second geometric center, wherein said first and second lenses have substantially identical optical power in the range between about +0.5 to +2.5 diopters to provide off-the-shelf correction for a user having normal uncorrected or spectacle vision when viewing a computer screen.

[0018] In some embodiments stock computer eyewear is disclosed, said stock computer eyewear comprising: a first lens having a first lateral edge and a first medial edge, the first lens having a greater thickness at the first medial edge than at the first lateral edge; and a second lens having a second lateral edge and a second medial edge, the second lens having a greater thickness at the second medial edge than at the second lateral edge, wherein said first and second lenses have substantially identical optical power in the range between about +0.5 to +2.5 diopters to provide off-the-shelf correction for a user having normal uncorrected or spectacle vision when viewing a computer screen.

[0019] In some embodiments stock computer eyewear is disclosed, said stock computer eyewear comprising: first and second lenses each having optical power in the range between about +0.5 to +2.5 diopters, said first and second lenses having substantially identical optical power to provide off-the-shelf correction for a user having normal uncorrected or spectacle vision when viewing a computer screen, each lens having a base curve and an ocular curve; and a frame portion disposed about said first and second lens portions to provide support, wherein said eyewear has a base curvature of at least base six.

#### BRIEF DESCRIPTION OF THE DRAWINGS

[0020] For purposes of summarizing the disclosure, certain aspects, advantages and novel features of the inventions have been described herein. It is to be understood that not necessarily all such advantages may be achieved in accordance with any particular embodiment of the invention. Thus, the invention may be embodied or carried out in a manner that achieves or optimizes one advantage or group of advantages as taught herein without necessarily achieving other advantages as may be taught or suggested herein. Certain

embodiments are schematically illustrated in the accompanying drawings, which are for illustrative purposes only.

[0021] FIG. 1 is a top perspective view of eyewear that mitigates the symptoms of computer vision syndrome, according to one embodiment;

[0022] FIG. 2 is a front perspective view of the eyewear of FIG. 1;

[0023] FIG. 3 is a side perspective view of the eyewear of FIG. 1;

[0024] FIG. 4 is a diagram of eyewear with decentered lenses for use in a wrap-around design, according to one embodiment;

[0025] FIG. 5 is a magnified cross-sectional view of a lens of FIG. 4;

[0026] FIG. 6 is a perspective view of eyewear that includes removable side-shields for reducing symptoms of computer vision syndrome, according to one embodiment;

[0027] FIG. 7 is a plot of the visible spectral emission of a typical fluorescent lamp;

[0028] FIG. 8 illustrates one embodiment of a non-uniform optical treatment for performing spatial filtering of light incident upon a lens;

[0029] FIG. 9 illustrates another embodiment of a non-uniform optical treatment for performing spatial filtering of light incident upon a lens;

[0030] FIG. 10 illustrates one embodiment of an optical treatment for performing spatial filtering of light incident upon a lens; and

[0031] FIG. 11 illustrates one embodiment of an optical treatment for performing spatial filtering of light incident upon a lens.

#### DETAILED DESCRIPTION OF THE PREFERRED EMBODIMENT

[0032] Example embodiments of eyewear for enhancing the experience of viewing a near object, such as a computer screen, for extended periods of time are described herein. The eyewear is non-prescription eyewear; it can be used without the requirement of an optometric examination and can be mass-manufactured without regard to the specific optical prescription of the end-user's eyes.

[0033] As described herein, computer Vision Syndrome (CVS) is a condition which can result from focusing the eyes on a computer display for protracted periods of time. Common symptoms of CVS are blurred vision, headaches, musculoskeletal pain and fatigue,



eye strain, dry eyes, difficulty in focusing the eyes at various distances, double vision, and light sensitivity.

[0034] Relaxed eyes focus at a distance called the resting point of accommodation. For normal, healthy eyes, the resting point of accommodation is further away than the typical range of distances for viewing a computer monitor or other relatively near object upon which a person may fixate for substantial periods of time. Therefore, viewing a computer screen typically requires eye muscles to contract to bring an image of the screen, formed by the physiologic lenses, into focus at the retinas. This process of contracting eye muscles to increase the optical power of the corneal lenses is called accommodation. With extended, repetitive use, eye muscles used for accommodation tire. When the accommodation system begins to fail, an adaptation used to help clear optical blur is the pin-hole effect created by squinting. The increased use of facial muscles for the purpose of squinting and repetitive use of the intra-ocular muscles of the accommodative system can create some of the discomfort associated with many symptoms of CVS. In some cases, repetitive viewing of near objects, such as a computer screen, can even lead to long-term vision degeneration.

[0035] Vergence demand can also lead to symptoms of CVS. Vergence is the simultaneous movement of the eyes in opposite directions to maintain binocular vision. Just as normal eyes have a resting point of accommodation, they also have a resting point of vergence. Typically, the resting point of vergence causes the respective lines of sight of the left and right eyes to converge at a point that is further away than the typical viewing distance of a computer monitor. When viewing a near object, such as a computer monitor, eye muscles must rotate the eyes inwardly (toward the nose) so that both eyes converge upon the same point. As is the case for use of eye muscles for accommodation, extended contraction of eye muscles to converge on a near point can cause discomfort as well as vision problems. In addition, the systems of vergence and accommodation are linked in the brain stem. When the eyes accommodate, they converge. Some imbalances between these systems can cause symptoms of CVS with extended near work.

[0036] While many symptoms of CVS are caused by strain in the eye and face muscles to meet accommodation and vergence demands while viewing relatively near

objects, there are also other factors which contribute to CVS. For example, studies have shown that people tend to blink less often than normal while viewing a computer screen or concentrating on near objects. Staring and decreased frequency of blinking can cause the eyes to dry out, leading to discomfort. Making matters still worse is the fact that many work environments include relatively dry air currents from HVAC equipment that increase tear evaporation and dryness in the eyes.

**[0037]** Some embodiments of the eyewear described herein mitigate symptoms generally associated with CVS. For example, some embodiments of the eyewear include lenses with a relatively small amount of optical power for lessening accommodation demands upon a user's eyes while viewing a computer screen through the eyewear at a typical working distance. The eyewear can also include an amount of prismatic power for lessening convergence demands upon a user's eyes while viewing a computer screen through the eyewear at a typical working distance. Some embodiments of the eyewear also include optical coatings, and other types of optical treatments, for performing spectral and spatial filtering upon light passing through the lenses in order to achieve desirable effects described herein, such as altering the spectrum of light that is incident upon the user's retinas .

**[0038]** In some embodiments, the eyewear has a wrap-around design. The wrap-around design shields the eyes from air currents that could otherwise deprive the eyes of their natural moisture, helping to prevent uncomfortable dryness of the eyes. The eyewear may also include additional features for lessening air currents in the vicinity of the user's eyes, such as side-shields removably attached to the eyewear. In some embodiments, the wrap-around design, removable side-shields, and other features also aid in blocking extraneous light from reaching a user's eyes. Such extraneous light can increase glare, making it more difficult for a user to comfortably view an object such as a computer monitor.

**[0039]** FIG. 1 is a top perspective view of computer eyewear 110 that mitigates the symptoms of computer vision syndrome, according to one embodiment. The computer eyewear 110 includes a frame 115, left and right lenses 120, left and right ear stems 125, and a nose piece 130. FIG. 2 is a front perspective view of the computer eyewear 110 of FIG. 1, while FIG. 3 is a side perspective view of the computer eyewear 110 of FIG. 1.

[0040] As illustrated in FIGS. 1-3, the frame 115 is configured to support the lenses 120 in front of a user's eyes. The frame 115 is illustrated as a unitary piece with enclosures for the lenses 120 connected by a bridge portion 16. The bridge portion 16 is located at a medial region of the computer eyewear 110 and helps support the computer eyewear 110 on a user's nose. The frame 115 is coupled to left and right ear stems 125 at left and right lateral regions of the computer eyewear 110.

[0041] FIGS. 1-3 illustrate only a single embodiment of the frame 115 and one skilled in the art will recognize that computer eyewear frames can take many different shapes, sizes, and styles to suit the needs and aesthetic tastes of a wide variety of individuals. For example, the frame 115 may not be a unitary part but may instead comprise several pieces which are coupled together to form the frame 115. In some embodiments, the frame 115 does not entirely enclose the lenses 120 but instead supports them by one or more edges of the lenses 120. For example, the frame 115 may support the lenses 120 by their top edge 121 such that the lenses 120 suspend from the frame 115 downward in front of a user's eyes. Moreover, in some embodiments, the frame 115 need not support the lenses 120 by their edges but may instead be coupled to a surface of the lenses 120 by a fastener or adhesive.

[0042] As shown in FIGS. 1-3, the computer eyewear 110 also includes left and right ear stems 125 for supporting the eyewear 110 on a user's ears. The ear stems 125 are coupled to the frame 115 by hinges 126. The computer eyewear 110 also includes a nose piece 130 for supporting the eyewear 110 on a user's nose. It should be understood that any type of ear stem, hinge, nosepiece, or the like can be used with various embodiments of the computer eyewear 110. In addition, not all embodiments include each of the features illustrated in FIGS. 1-3, and some embodiments include additional features. For example, in some embodiments the computer eyewear 110 includes one or more straps to secure the eyewear to a user's head or clips to attach the computer eyewear 110 to a user's prescriptions eyeglasses.

[0043] In some embodiments, the frame 115 and/or ear stems 125 are made of metal, though other materials, such as plastics can also be used. Generally speaking, the frame 115 and ear stem 125 material can be chosen based on its strength, durability, density, and appearance. In some embodiments, relatively strong, low-density metals are

advantageously chosen for the frame 115 and/or ear stem 125 material. For example, strong, light-weight metals such as aluminum, magnesium, titanium, alloys of the same, and the like can be used. These materials allow for the design of sturdy, light-weight eyewear 110. Other materials may also be used.

[0044] Since the overall weight of the computer eyewear 110 is significantly affected by the weight of the frame 115 and ear stems 125, the usage of low-weight materials results in computer eyewear 110 that is more comfortable for a user over long periods of time than if a denser material had been chosen. For example, it may be typical for a user to wear the computer eyewear 110 for periods of up to ten hours per day or longer viewing a computer screen. In some embodiments, the user's level of comfort while using the computer eyewear 110 is enhanced because the overall weight of the computer eyewear 110 does not exceed approximately 40 grams. For example, in some embodiments the overall weight of the computer eyewear 110 is less than approximately 30 grams. In some embodiments, the overall weight of the computer eyewear 110 is less than approximately 20 grams. In some embodiments, the overall weight of the computer eyewear 110 is less than approximately 15 grams. Values outside these ranges are also possible.

[0045] As illustrated in FIGS. 1-3, the computer eyewear 110 has a dual-lens design with left and right lenses 120. In other embodiments, the computer eyewear 110 may have a unitary lens structure with separate regions of optical power positioned in front of the user's eyes. The lenses 120 have an ocular curve, which comprises the eye-side surface of the lenses 120, and a base curve, which comprises the opposing, or outer, surface of the lenses 120. As described herein, the lenses 120 can include a mirror coating, tinting, an anti-reflective (AR) coating, combinations of the same, or the like on one or more of the base and ocular lens surfaces.

[0046] The lenses 120 are positive-power, or converging, lenses that reduce the accommodation demand upon a user's eyes while viewing a computer screen or other relatively near object upon which the user fixates for significant periods of time. The accommodative demand is lessened because the positive optical power of the lenses 120 sets the user's resting point of accommodation at a distance that is closer to the distance of the computer screen, or other object, that the user is viewing while wearing the eyewear 110.

Since the positive optical power of the lenses 120 reduces accommodative demand, the user's eye muscles are permitted to relax, which in turn mitigates various symptoms of CVS.

[0047] In addition, the positive optical power of the lenses 120 may provide some magnification of objects nearer to the user than approximately the focal length of the lenses 120 by forming an enlarged virtual image of the object. Thus, in the case of a computer screen viewed at a distance less than the focal length of the lenses 120, text and images appearing on the computer screen are somewhat enlarged, allowing the user to read font sizes or see other details that would have been more difficult to perceive in the absence of the lenses 120.

[0048] In some embodiments, the optical power of the lenses 120 is greater than or equal to approximately +.5 diopters and less than or equal to approximately +.75 diopters. In some embodiments, the optical power of the lenses 120 is greater than or equal to approximately +.75 diopters and less than or equal to approximately +1 diopter. In some embodiments, the optical power of the lenses 120 is greater than or equal to approximately +1 diopter and less than or equal to approximately +1.125 diopters. In some embodiments, the optical power of the lenses 120 is greater than or equal to approximately +1.125 diopters and less than or equal to approximately +1.5 diopters. In some embodiments, the optical power of the lenses 120 is greater than or equal to approximately +1.5 diopters and less than or equal to approximately +1.75 diopters. In some embodiments, the optical power of the lenses 120 is greater than or equal to approximately +1.75 diopters and less than or equal to approximately +2 diopters. In some embodiments, the optical power of the lenses 120 is greater than or equal to approximately +2 diopters and less than or equal to approximately +2.125 diopters. In some embodiments, the optical power of the lenses 120 is greater than or equal to approximately +2.125 diopters and less than or equal to approximately +2.5 diopters.

[0049] The particular optical power chosen for the lenses 120 in an embodiment will generally depend upon the physical set-up of the user's workspace, such as the distance between a user and his computer screen, as well as the user's viewing preferences, and, in some embodiments, the user's eyesight. In some embodiments, the eyewear 110 is off-the-shelf, non-prescription eyewear, such that the optical power in each of the lenses 120 is substantially identical.

[0050] Various lens shapes can be used to achieve the desired optical power, according to various embodiments. For example, the lenses 120 can have a convex, plano-convex, or convex-concave shape. Other shapes can also be used to achieve lenses 120 with optical power in the range between approximately +.5 and +2.5 diopters, and are known to those skilled in the art. The lenses 120 can be spherical or aspheric. While in the embodiments illustrated in FIGS. 1-3 the lenses 120 are non-progressive lenses, progressive lenses can also be used.

[0051] In addition to being designed with an amount of focusing power, the lenses 120 can also be designed to display an amount of base-in prismatic power. The resting point of vergence of normal, healthy eyes is typically more distant than the location of a computer screen or other relatively near object upon which a user fixates for long periods of time. Thus, viewing such an object places convergence demand upon the muscles of the eyes and can result in strain and other symptoms of CVS. The resting point of vergence can be drawn in closer by designing the lenses to exhibit an amount of base-in prismatic power, according to methods known in the art. The base-in prismatic power of the lenses 120 can be set such that the user's resting point of vergence is located at approximately the distance of, for example, the user's computer screen while the user is working at his computer. In some embodiments, each of the lenses 120 of the computer eyewear 110 are designed with base-in prismatic power of about .25-1.5 prism diopters. In other embodiments, however, the lenses 120 have approximately zero prismatic power.

[0052] A wide variety of materials can be used to form the lenses 120. The lens material may be selected based upon properties of the material, such as refractive index, strength, Abbe number, density, and hardness. For example, the lenses 120 can be formed of polycarbonate, glass, nylon, various polymers (e.g., CR-39), or plastic. In some embodiments, high-refractive index materials are used to allow for the design of thinner, lighter lenses 120 that are more comfortable to wear to extended periods of time than eyewear 110 with lenses 120 made of a lower-index material. For example, in some embodiments, the refractive index of the lens material lies approximately in the range between 1.498 and 1.9, although the refractive index can be higher or lower.

[0053] The computer eyewear 110 can be effectively used by individuals with substantially normal (e.g., approximately 20/20) uncorrected vision. The eyewear can also be effectively used by individuals with normal corrected, or spectacle, vision. For example, users who wear contact lenses can effectively use the computer eyewear 110, in addition to their contact lenses, while working at a computer to mitigate the symptoms of CVS. Some embodiments of the computer eyewear 110 are also designed to be worn by those individuals who wear prescription eyeglasses to correct their vision. For example, the computer eyewear 110 can be designed to be worn over or attach to (e.g., clip-on eyewear) the user's prescription eyewear. In addition, in some embodiments, the computer eyewear 110 can be effectively used by individuals without normal vision, such as for example, presbyopes. Various embodiments, however, are non-prescription, off-the-shelf products.

[0054] While certain symptoms of CVS are caused by straining of the eye muscles as a result of accommodation and convergence demand while viewing a relatively near object such as a computer screen for extended periods of time, other symptoms are caused by the microclimate in the vicinity of the user's eyes. If the microclimate in the vicinity of the user's eyes becomes too dry, dry eye syndrome can result, causing soreness and irritation of the eyes. This problem is particularly acute for computer users because studies have shown that for most people blink rate tends to decrease while viewing a computer screen. This problem is exacerbated in office environments by the relatively dry air from air conditioners as well as air currents from office HVAC systems that also tend to dry out the eyes of a user. Extraneous light that enters the eyes from the peripheral regions of a user's vision can also worsen the symptoms of CVS. For example, such extraneous light can result in glare and loss of contrast, which makes it more difficult for the user to view a computer screen, for example.

[0055] In some embodiments, the computer eyewear 110 has a wrap-around design to mitigate the symptoms of CVS related to the microclimate in the vicinity of a user's eyes as well as to curtail the amount of extraneous light that reaches the eyes. Wrap-around designs are not used in conventional computer eyewear. These designs are typically used to provide protection against dust or other projectiles while participating in outdoor recreational activities – protection that is generally unnecessary in an office environment. However, a

wrap-around design can also help mitigate symptoms of CVS, especially when used in conjunction with other features described herein. Unlike conventional computer eyewear, embodiments of the computer eyewear 110 with a wrap-around design have a relatively high base curvature such that the computer eyewear has wrap and conforms closely to the user's face both in the frontal and peripheral regions of the user's vision. The wrap-around design improves the microclimate in the vicinity of the user's eyes by reducing air currents around the eyes and by allowing for the formation of a pocket of air on the ocular side of the lenses 120 with increased humidity relative to the ambient air on the base curve side of the lenses. In some embodiments, the wrap-around design also reduces the amount of extraneous light that enters a user's eyes from the peripheral field of vision.

[0056] One embodiment of computer eyewear 120 with a wrap-around design is illustrated in FIGS. 1-3. Unlike conventional computer eyewear, typically having a base curvature less than base 4, the base curvature of the frame 115 and lenses 120 maintains a relatively close fit to the user's face even at the peripheral regions of the user's field of view. In addition to closely following the curvature of a user's head, the frame 115 and lenses 120 of the eyewear 110 can be designed to complementarily follow the contours of a typical user's facial features to maintain a small separation distance between the frame 115 and the user's face. For example, the frame 115 and lenses 120 can be designed to maintain no more than a small degree of separation with the user's brow and cheekbones.

[0057] In some embodiments, the separation between the brow and an upper aspect, such as the upper edge, of the frame 115 (e.g., in the z-direction) is 12 mm or less. For example, in some embodiments, the separation between the brow and an upper aspect of the frame 115 is approximately 2-5 mm. In some embodiments, the separation between the brow and an upper aspect of the frame 115 is less than approximately 2 mm. In some embodiments, the distance between the cheekbone and a lower aspect, such as the lower edge, of the frame 115 (e.g., in the z-direction) is less than 5 mm. For example, in some embodiments, the separation between the cheekbone and a lower aspect of the frame is approximately 1-3 mm. In some embodiments, the separation between the cheekbone and a lower aspect of the frame is less than approximately 1 mm. In some embodiments, the separation between the temple region and the frame 115 (e.g., in the z-direction) is 35 mm or



less. For example, in some embodiments, the separation between the temple region and the frame 115 is approximately 5-10 mm. In some embodiments, the separation between the temple region and the frame 115 is less than approximately 5 mm. In some circumstances, a standard anatomical human head form can serve as a useful indicator of dimensions of a typical user's head and facial features.

[0058] Whereas in the case of conventional computer eyewear the peripheral region of a user's field of view is left exposed, the computer eyewear 110 of FIGS. 1-3 protects the user's eyes against air currents and extraneous light that could cause symptoms of CVS. In some embodiments, the computer eyewear 110 has a base curvature of base 5 or higher. In other embodiments, the computer eyewear 110 has a base curvature of base 6 or higher. In other embodiments, the computer eyewear 110 has a base curvature of base 8 or higher. In other embodiments, the computer eyewear 110 has a base curvature of base 10 or higher. As a result, the frame 115 and lenses 120 exhibit wrap. In addition, in some embodiments, the computer eyewear 110 is designed with an amount of pantoscopic tilt, or rake.

[0059] With reference to FIG. 1, in some embodiments the lenses 120 extend from their medial edge in the  $\pm y$ -direction by a distance  $d_1$ , and from the front surface in the  $z$ -direction by a distance  $d_2$ . In some embodiments,  $d_1$  is approximately 45-70 mm and  $d_2$  is approximately 20-40 mm. In some embodiments, the ratio of  $d_1$  to  $d_2$  is approximately 1.5-3.5.

[0060] The wrap-around computer eyewear 110 improves the microclimate in the vicinity of the user's eyes by blocking a portion of the air flow around the eyes that exists when a user wears a conventional pair of computer eyewear. Since air flow to the eyes is decreased, the amount of water vapor from the natural moisture of the eyes that is carried away by the air flow is also decreased. As a result, the air in a pocket formed around the eyes by the wrap-around computer eyewear 110 has a higher level of humidity than the ambient air. The increased humidity in a pocket of air trapped between the wrap-around computer eyewear 110 and the user's face helps to reduce dryness of the eyes and other associated symptoms of CVS. While in some embodiments, all or portions of the frame 115 of the computer eyewear 110 may be designed to be in physical contact with a user's face to form a

sealed chamber around the eyes, in other embodiments, the microclimate around the user's eyes can be enhanced appreciably if all or portions of the frame 115 are designed to closely conform to facial features, as described herein, though without forming a sealed chamber. Computer eyewear 110 that is not designed to form a sealed chamber around the eyes may be more comfortable to some users than computer eyewear 110 with a sealed chamber around the eyes.

**[0061]** In some embodiments, the design of the computer eyewear 110 blocks sufficient air flow around the eyes to allow for the percent relative humidity of the air on the ocular curve-side of the eyewear 110 to reach a level that is ten percentage points higher than the percent relative humidity of the ambient air. In some embodiments, the percent relative humidity of the air on the ocular curve-side of the computer eyewear 110 is at least about 40% or higher, while in some embodiments it lies in the range between about 40% and 60%.

**[0062]** While the wrap-around configuration illustrated in the computer eyewear 110 of FIGS. 1-3 advantageously helps to regulate the microclimate around a user's eyes as well as blocking some extraneous light, under some circumstances it can also have a deleterious impact on the optical performance of the lenses 120. For example, if the lenses 120 are canted with respect to a user's forward line of sight to provide wrap while the computer eyewear 110 is in the as-worn position, a degree of base-out prismatic power may be introduced along with other optical distortions. In addition, pantoscopic tilt can induce cylindrical optical power in the lenses 120, along with other optical distortions. These optical distortions can, however, be corrected to a certain extent by implementing decentered lenses in the computer eyewear 110.

**[0063]** FIG. 4 is a diagram of eyewear 410 with decentered lenses 420 for use in a wrap-around and/or raked design, according to one embodiment. Front and rear surfaces of one of the decentered lenses 420 follow a first arc 421 and a second arc 422, respectively. The first arc 421 is a portion of a circle with radius  $R1$  and a center point  $C1$ . The first arc 421 defines a convex surface. The second arc 422 defines a concave surface and is a portion of a circle with radius  $R2$  that, in some embodiments, is greater than  $R1$ . The circle that defines the second arc 422 has a center point  $C2$  that is offset from  $C1$ . In some embodiments, the center point  $C2$  of the second arc 422 is set away from the lenses 420 and

to the medial side of C1. Thus, in some embodiments, the lenses 420 are convex-concave lenses with an amount of positive optical power. In some embodiments, the lenses 420 have at least about +.5 diopters of positive optical power.

[0064] In FIG. 4, an optical center line 470 is drawn between the center points C1 and C2. The optical center line 470 intersects the thickest portion (i.e., the optical center) of the lens 420. A geometric center of the lens 420 can be defined in ways known by those of skill in the art (e.g., at the intersection of an A line, that defines the horizontal width of the lens, with a B line, that defines the vertical height of the lens). In addition, a forward line of sight 460 is drawn to indicate the direction of a user's line of sight while looking straight forward. As shown in FIG. 4, the optical center line 470 and the forward line of sight 460 are separated by an angle  $\theta$ . Thus, in one embodiment, the optical center line 470 and the forward line of sight 460 are not parallel. In other embodiments, however, the optical center line 470 is parallel with the forward line of sight 460, while in still other embodiments, the angle  $\theta$  is negative as compared to how it is illustrated in FIG. 4.

[0065] The decentered lenses 420 can be configured to correct the base-out prismatic power that would otherwise be introduced in a non-decentered lens due to the canted orientation of the lenses 420 in a wrap-around design of computer eyewear. Reduction or correction of the base-out prismatic power can be accomplished by adding an amount of base-in prismatic power. The amount of prismatic power can be controlled by varying the location of the center point C2 with respect to C1. This variation can consequently vary the angle  $\theta$  between the optical center line 470 and the forward line of sight 460, as well as the distance between the center points C1 and C2.

[0066] One way of adding base-in prismatic power is to decenter the optical center of the lens 420 medially with respect to the geometric center. For example, the lenses can be designed such that the distance between the optical centers of the left and right lenses 420 is less than a given pupillary distance such that the optical centers of the lenses 420 are offset medially from the y positions of the user's pupils. In non-prescription embodiments, the distance between optical centers of the left and right lenses 420 can be chosen with respect to a pupillary distance that is representative of a wide range of users. For example, the population median pupillary distance of approximately 62 mm can be chosen, though the

lenses 420 can also be designed for other pupillary distances. In other embodiments, the optical center of the lens 420 can be decentered laterally with respect to the geometric center.

**[0067]** In some embodiments, the decentered lenses 420 are configured to cancel out the base-out prismatic power otherwise introduced by the wrap-around design so that the lenses 420 of the computer eyewear have substantially no prismatic power. In other embodiments, the decentered lenses 420 are configured to cancel out the base-out prismatic power as well as adding an amount of base-in prismatic power to reduce the convergence demand upon the eye muscles while viewing, for example, a relatively near computer screen. The amount of prism induced by the decentration can be calculated with Prentice's Rule. Besides being decentered in the  $\pm y$  direction, as illustrated in FIG. 4, the optical centers of the lenses 420 can also be decentered in the  $\pm x$  direction to help correct optical distortions induced by pantoscopic tilt. For example, the optical centers of the lenses 420 can be decentered upward or downward with respect to the geometric centers of the lenses 420 based on the pantoscopic tilt.

**[0068]** FIG. 5 is a magnified cross-sectional view of a lens 520 of FIG. 4. Several measurements of the lens 520 are indicated on FIG. 5, including R1, R2, the lateral end thickness 501, the medial end thickness 502, and the distance between the midpoint 503 of the lens 520 and the thickest point 504 of the lens 520. As illustrated in FIG. 5, the medial end thickness 502 and the lateral end thickness 501 are each less than the thickness of the lens 520 at the thickest point 504. Moreover, the medial end thickness 502 is greater than the lateral end thickness 501. The thickest point 504 of the lens 520 is closer to the medial edge than to the lateral edge of the lens 520. As disclosed herein, the lens 520 has a degree of positive optical power in some embodiments. Moreover, while FIG. 5 illustrates a converging convex-concave lens 420, in other embodiments different types of converging lenses can be used.

**[0069]** In one embodiment, the lens 520 is a base 8 decentered lens with +.5 diopters of optical power. In this embodiment, the approximate values of the measurements of R1, R2, the lateral end thickness 501, the medial end thickness 502, and the distance between the midpoint 503 and the point of maximum thickness 504 are as follows: 63.75 mm, 68 mm, .9 mm, 1.837 mm, and 7.9 mm, respectively. In another embodiment, the lens

520 is a base 6 decentered lens with +.5 diopters of optical power. In this embodiment, the approximate values of the measurements of R1, R2, the lateral end thickness 501, the medial end thickness 502, and the distance between the midpoint 503 and the point of maximum thickness 504 are as follows: 85 mm, 92.72 mm, 1.1 mm, 2.084 mm, and 8.566 mm, respectively. These lenses have refractive indexes chosen to result in an optical power of +.5 diopters.

[0070] In addition to the wrap-around design for computer eyewear disclosed herein, other features can also be used to enhance the microclimate around a user's eyes. For example, some embodiments include removable side-shields that can reduce air flow to the eyes. FIG. 6 is a perspective view of eyewear 610 that includes removable side-shields 635 for reducing symptoms of CVS. The computer eyewear 610 has a unitary lens with positive optical power, a frame 615, ear stems 625, and a nose piece 430, as described herein. The computer eyewear 610 also includes removable side-shields 635. The side-shields 635 are configured to removably connect to and from the computer eyewear 610, thus permitting the user to decide under what circumstances to use the side-shields. The removable side-shields 635 are configured, in shape and size, to substantially reduce air flow to the eyes from the lateral regions of the computer eyewear 610. For example, in the embodiment illustrated in FIG. 6, the removable side-shields 635 help to close the space between the ear stems 625 and the side portion of a user's face, including the cheekbone and temple area.

[0071] In one embodiment, the dimensions of the removable side-shields 635 are approximately 20-80 mm in the z dimension and approximately 15-50 mm in the x dimension at the front of the computer eyewear, tapering down to approximately 5 mm at the rear (e.g., nearer the user's ear). While, FIG. 6 illustrates computer eyewear 610 with a wrap-around design, the removable side-shields 635 can also be used with computer eyewear without a wrap-around design.

[0072] The removable side-shields 635 have tabs 640 for removably fastening the side shields 635 to the frame 615 and ear stems 625 of the computer eyewear 610. The tabs 640 are configured to complementarily mate with apertures 645 located in the frame 615 and ear stems 645 where they are securely held in place. In some embodiments, the removable side-shields 635 attach to the frame 615 and/or ear stems 625 in a snap-on fashion. While

FIG. 6 illustrates connection points between the tabs 635 and apertures 645 at the frame 615 and ear stems 625, the connection points could be limited to only the frame 615 or only the ear stems 625. In addition, the removable side-shields could connect to the lens 620, or to some other portion of the computer eyewear 620. While a suitable tab/aperture fastener for removably attaching the side shields 635 to the computer eyewear 610 is illustrated in FIG. 6, those of ordinary skill in the art will recognize that many different types of fasteners could be used equally well. For example, friction fit fasteners, claw fasteners, sliding groove fasteners, or magnetic fasteners can all be used to removably attach the side shields 635 to the computer eyewear 610 in various embodiments.

[0073] The removable side-shields 635 can be made of a variety of materials. For example, metals and plastics are suitable materials. In one embodiment, the removable side-shields 635 are made of the same material as the frame 615 and ear stems 625 of the computer eyewear 610. In addition, the removable side-shields 635 can be transmissive to light or substantially opaque. In embodiments where the removable side-shields 635 are substantially opaque, they can perform the additional role of reducing the amount of extraneous light that is incident upon the eyes from the user's peripheral field of vision, along with symptoms of CVS related to such extraneous light.

[0074] The lenses 120 of certain embodiments of the computer eyewear 110 include one or more optical treatments to alter the optical performance of the lenses 120. For example, the lenses 120 may include a partial mirror coating that comprises one or more metal and/or dielectric layers formed on the lenses 120 (e.g., an aluminum coating, a  $\lambda/4$  stack, etc.). The partial mirror coating can be formed by vacuum deposition, physical vapor deposition, lamination of a sheet of reflective material on a lens surface, for example, with an adhesive, or any other thin film coating technology. In some embodiments, the partial mirror coating is at least 15% reflective across all, or a portion of, the visible spectrum of light from about 340 nm to about 780 nm. In some embodiments, the reflectivity of the partial mirror coating is greater than 95% reflective for all or a portion of the visible spectrum.

[0075] The lenses 120 can also include a tint. The tint may comprise a pigment, dye, optically absorptive layer, a photoreactive dye, or a tinting material laminated onto a lens surface, for example. In addition, in some embodiments, the lenses 120 include an anti-

reflective (AR) coating. The AR coating can comprise one or more thin films formed on the surface of a lens through vacuum deposition, physical vapor deposition, lamination of an AR layer on a lens surface, or some other method.

[0076] In some embodiments, the optical treatments are uniform across the surface of the lenses 120, while in other embodiments they are non-uniform. Some embodiments include a first optical treatment that is uniform, and a second optical treatment that is non-uniform. Moreover, in some embodiments an optical treatment covers greater than 90% of a surface of the lenses 120, while in other embodiments the optical treatment covers 50%-90% of a lens surface, 10%-40% of a lens surface, or less than 10% of a lens surface.

[0077] Optical coatings and treatments such as the types described herein can be used to spectrally filter light that passes through the lenses of the computer eyewear. This type of spectral filtering can be done to modify the spectrum of light that is incident upon the eyes in ways that help to reduce symptoms of CVS. For example, in some embodiments, optical coatings as well as other types of treatments are applied to the lenses to attenuate peaks in the spectra of typical fluorescent and incandescent lighting found in homes and offices. This can be done, for example, with a partially transmissive mirror coating, tinting, a combination of the same, or the like.

[0078] FIG. 7 is a plot 700 of the visible spectral emission of a typical fluorescent lamp. The curve 710 indicates power of the spectral emission of the fluorescent lamp as a function of wavelength. The curve 710 includes peaks 720, such as those seen at approximately 360 nm, 400 nm, 440 nm, 550 nm, and 575 nm. A plot of the spectral emission of a typical incandescent lamp, while not shown, has similar spectral peaks. The spectral peaks in these typical sources of lighting can result in poor contrast when viewing, for example, a computer screen. This in turn can cause the eyes to strain. People generally tend to prefer the viewing conditions presented by a more balanced spectrum as opposed to the viewing conditions under light with defined spectral peaks.

[0079] Therefore, some embodiments of the computer eyewear 110 include optical treatments applied to the lenses 120 to attenuate spectral peaks (e.g., 720) in various types of artificial lighting. For example, various embodiments include optical treatments for

attenuating spectral peaks in fluorescent lighting as seen in FIG. 7. Other embodiments can be customized for other types of lighting or for fluorescent lighting with different spectral peaks than those illustrated in FIG. 7. Optical treatments with the desired spectral characteristics for attenuating spectral peaks in various types of lighting can be designed using techniques known in the art.

[0080] For example, in one embodiment, an optical treatment for attenuating the peaks 720 in the lighting spectrum 710 shown in FIG. 7 has stop bands at approximately 360 nm, 400 nm, 440 nm, 550 nm, and 575 nm. The positions of the stop bands are selected to correspond to the positions of peaks in output spectrum 710 of the fluorescent lighting. The width of the stop bands, in a full width at half maximum sense, can be in the range of about 25 nm to about 150 nm wide in some embodiments, although the widths may be larger or smaller. In some embodiments, the width of the stop band may substantially equal the spectral width of a peak 720 in the emission spectrum of the lighting.

[0081] In some embodiments, the stop bands reduce the transmission of light through the lenses 120 by at least about 50%. Furthermore, in some embodiments, the attenuation of transmitted light provided by each stop band is designed to be proportionate, or otherwise related, to the height of the particular spectral peak which it is designed to attenuate. For example, the stop band at 440 nm can provide greater attenuation than the stop band at 360 nm. The precise characteristics of a spectral filter for attenuating peaks in the output spectrum 710 can vary widely, as will be appreciated by those of skill in the art. In this way, the optical treatment advantageously balances the spectrum of light that reaches a user's eyes. This balanced spectrum results in more natural viewing conditions that can lessen eye strain. In a similar manner, optical treatments can be designed to balance the spectrum of incandescent lighting as well as other types of lighting.

[0082] Balancing the spectrum of ambient light (e.g., fluorescent office lighting) can also have other benefits. For example, in some cases the light emitted from a backlit computer display does not share one or more of the spectral peaks of the ambient lighting that the optical treatment is designed to attenuate. In these cases, the optical treatment preferentially attenuates ambient lighting over light emitted from the computer display. In some circumstances, light that is incident upon the eyes from sources (e.g., overhead office



lighting) other than a backlit computer display being viewed by the user can be considered as a source of optical “noise” that makes it more difficult for the user to view the computer display without straining. By preferentially attenuating light from these sources of noise, the ratio of light from the computer display to ambient lighting noise is increased, resulting in more comfortable viewing of the computer display and reduced symptoms of CVS.

**[0083]** In some embodiments, the optical treatment for balancing the output spectrum of fluorescent lighting, or any other type of lighting, is a partially transmissive mirror coating. While a tint can also be used for this purpose, the spectral characteristics of a partially transmissive mirror coating can generally be customized to a greater extent. For example, the spectral locations of various stop bands in a partially transmissive mirror coating can be customized to a greater extent than in the case of tinting. In addition, these stop bands can be designed to attenuate incident light by a greater amount, making the stop bands deeper than is generally possible with tinting. Nevertheless, in other embodiments, the optical treatment is a tint applied to the lenses of the computer eyewear 110 that attenuates transmitted light primarily by introducing absorptive loss. In still other embodiments, the optical treatment comprises both a partially transmissive mirror coating as well as an optically absorptive tint. The use of both a mirror coating and tinting can be advantageous in that it allows for an extra degree of freedom to customize the spectral response of the optical treatment.

**[0084]** In some embodiments, the computer eyewear 110 includes optical treatments to provide spatial filtering of light that is incident upon the lenses 120. Spatial filtering of light incident upon the lenses 110 can be used to preferentially attenuate the transmission of, or otherwise alter, light originating from a selected direction within a user’s field of view. This can be done, for example, by applying optical treatments to the lenses 120 that cause the optical characteristics of the lenses 120 to spatially vary across one or more lens surfaces. In some embodiments, optical treatments that provide spatial filtering of light can have broadband spectral characteristics such that they affect all visible wavelengths of light substantially equally (e.g., neutral density spatial filtering). In other embodiments, optical treatments for spatial filtering can be combined with separate optical treatments for performing spectral filtering of incident light, as described herein. In still other

embodiments, a single optical treatment, such as a partially transmissive mirror coating or tint, can be designed to perform both spectral and spatial filtering.

[0085] FIG. 8 illustrates one embodiment of a non-uniform optical treatment 800 (illustrated as shading) for performing spatial filtering of light incident upon a lens 803. The optical treatment 800 can be a partially transmissive mirror coating, tinting, a combination of the two, or the like. The lens 803 includes a center region 801, which in some embodiments encompasses the mechanical center, or centroid, of the lens 803. The lens 803 also includes periphery regions near the edge 802 of the lens 803. The periphery regions include an upper region, which can encompass, for example, any portion of the lens 803 nearer point A than point B. The periphery regions can also include a lower region, which can encompass, for example, any portion of the lens 803 nearer point B than point A. For other lens shapes, the center, periphery, upper, and lower regions may be defined differently.

[0086] Point A is located in the vicinity of the upper region of the lens 803, while point B is located in the vicinity of the lower region of the lens 803. The curve 852 of the graph 850 shows the transmission of light through the lens 803 as a function of the position along the line AB that is indicated on the lens 803. The dotted line 854 indicates the level of transmission of light through the lens in the absence of the optical treatment 800 whose characteristics are illustrated by the curve 852. For example, if the optical treatment 800 is a mirror coating, the dotted line 854 represents the amount of incident light that is transmitted through the lens 803 in the absence of the mirror coating, since not all incident light will be transmitted by the lens 803 even in regions with no mirror coating due to some amount of Fresnel reflection at the air-lens interface.

[0087] In this embodiment, the optical treatment 800 is configured such that the transmissivity of the lens 803 increases smoothly from point A to point B. Thus, the curve 852 illustrates one embodiment where the transmissivity of the lens 803 is lesser in the vicinity of the upper region than in the vicinity of the middle and lower regions. In some embodiments, the transmissivity of the lens 803 in the lower region is at least about 15% less than in the upper region, and could be as much as approximately 70% less. While a transmission curve 852 is only indicated along the line AB, it should be understood that similar curves could be drawn for other lines between upper and lower regions of the lens

803 to indicate a generally lower transmissivity in the upper regions of the lens than in the lower regions, as roughly illustrated by the shading on the lens 803. Furthermore, in other embodiments, the transmission curve 852 can increase from A to B according to any other smooth path, including a linear path. The transmission curve 852 can be monotonic, but this is not required. Smooth transitions may be desirable in certain embodiments to avoid harsh transitions in the optical characteristics of the lens 803 between different regions in a user's field of view. However, discontinuous jumps in the transmission curve 852 are also possible and desirable in some situations. In fact, the transmission curve 852 may include more than one discontinuous jump such as, for example, a step transition from one level of transmissivity to another.

[0088] In the case where the optical treatment 800 is a partially transmissive mirror coating, the decreased transmissivity of the lens in the upper region is due principally to the fact that the reflectivity of the mirror coating is greater in the upper region of the lens 803. Increased reflectivity of the partially transmissive mirror coating near the upper region can be accomplished, for example, by making the partially transmissive mirror coating thicker in the upper region of the lens 803. In the case where the optical treatment 800 is a tinting material, decreased transmissivity of the lens 803 in the upper region near point A is due principally to increased absorptivity of the tinting material in the upper region of the lens 803. In either case, however, the dotted line 854 indicates the level of transmissivity of the lens 803 in the absence of the optical treatment 800. Thus, since the transmission curve 752 reaches up to the dotted line 754, at least a portion of the lens 803 is not affected by the optical treatment 800 in this embodiment.

[0089] Embodiments like the one illustrated in FIG. 8 where the transmissivity of the lens 803 in the upper region is lesser than the transmissivity of the lens in the middle and lower regions can be useful in preferentially attenuating the transmission of light that originates in a user's upper field of view. For example, when a user is seated at a computer terminal, the optical treatment 800 which provides for decreased transmissivity in the upper region of the lens 803, preferentially attenuates overhead lighting. This can reduce glare from the overhead lighting and make for more comfortable viewing of a computer terminal,

reducing various symptoms of CVS. In addition, the optical treatment 800 can be configured to attenuate spectral peaks in the spectrum of the overhead lighting, as described herein.

**[0090]** FIG. 9 illustrates another embodiment of a non-uniform optical treatment 900 (illustrated by the shading on lens 903) for performing spatial filtering of light incident upon a lens 903. The optical treatment 900 can be a partially transmissive mirror coating, tinting, a combination of the two, or the like. As described with reference to the lens 803 of FIG. 8, the lens 903 includes a center region 901 as well as periphery regions. The periphery regions include an upper region, and a lower region. The periphery regions also include first and second side regions, which can encompass, for example, any portion of the lens 903 nearer point C than point D for the first region, or nearer point D than point C for the second region.

**[0091]** Point A is located in the vicinity of the upper region of the lens 903, while point B is located in the vicinity of the lower region of the lens 903. The curve 952 of the graph 950 shows the transmission of light through the lens 903 as a function of position along the line AB that is indicated on the lens 903. The dotted line 954 indicates the level of transmission of light through the lens in the absence of the optical treatment whose characteristics are illustrated by the curve 952. Similarly to the embodiment illustrated in FIG. 8, the optical treatment is configured such that the transmissivity of the lens 903 increases smoothly from point A to point B.

**[0092]** Point C is located in the vicinity of the first side region of the lens 903, while point D is located in the vicinity of the second side region of the lens 903. Similarly to curve 952, curve 958 of the graph 956 shows optical transmission versus position on the lens. However, curve 958 shows the transmissivity profile of the lens along line CD. Again, the dotted line 960 indicates the level of transmission of light through the lens in the absence of the optical treatment 900 whose characteristics are illustrated by the curve 958. The optical treatment 900 is configured such that the transmissivity of the lens 903 varies smoothly from point C to point D and is lesser in the vicinity of the first and second side portions than in the vicinity of the middle region.

**[0093]** While only two transmission curves 952 and 958 are indicated for the lens 903, it should be understood that similar curves could be drawn for other lines on the lens

903 to indicate a generally lower transmissivity in the upper and side regions of the lens than in the middle and lower-middle regions, as roughly illustrated by the shading on lens 903. In some embodiments, the transmissivity of the lens 903 varies smoothly, whether monotonically or not, from the upper and side regions to the middle and lower-middle regions. In other embodiments, the transmissivity can discontinuously jump between one or more levels of transmissivity.

[0094] Embodiments where the transmissivity of the lens 903 in the upper and side regions is lesser than the transmissivity of the lens 903 in the middle and lower-middle regions can be useful in preferentially attenuating the transmission of light that originates in the upper and side portions of a user's field of view. For users working at a computer, this type of spatial filtering selectively attenuates light from most sources other than a computer screen located in the middle region of a user's field of view, as well as a desk area located in a lower region of the user's field of vision. This type of embodiment reduces glare, not only from overhead lighting, but also from other sources of light, including reflections, in other portions of the user's periphery field of view.

[0095] FIG. 10 illustrates another embodiment of an optical treatment 1000 for performing spatial filtering of light incident upon a lens 1003. Similarly to the embodiment illustrated in FIG. 9, the lens 1003 includes an optical treatment 1000 that causes the upper and side regions of the lens 1003 to have a lesser transmissivity than the middle and lower-middle portions. The optical treatment 1000 can be a partially transmissive mirror coating, tint, a combination of the two, or the like. A distinctive feature of the optical treatment 1000 in this embodiment is that it establishes a baseline level of reduced transmission of light over substantially the entire lens 1003 surface. The level of transmission of light through the lens 1003 then decreases from the baseline level in some regions of the lens 1003.

[0096] The baseline level of reduced transmission of light through the lens 1003 is illustrated by the gap between the dotted line 1054 and the transmission curve 1052 in graph 1050, as well as between the dotted line 1060 and the transmission curve 1058 in graph 1056. As before, the dotted lines 1054 and 1060 indicate the level of transmission of light through the lens 1003 in the absence of the optical treatment 1000 whose characteristics are illustrated by the transmission curves 1052 and 1058. The gaps show that the optical

treatment 1000 applied to the lens 1003 at least partially attenuates the transmission of light over substantially the entire lens surface and provides a baseline level of attenuation of transmitted light.

[0097] For example, a partially transmissive mirror coating can be applied to substantially the entire lens 1003. The mirror coating can be configured to provide a minimum level of reflectivity in the regions of the lens 1003 where the transmission of light through the lens 1003 is greatest. For the embodiment of FIG. 10, the regions of greatest transmissivity are the middle and lower-middle regions of the lens. The reflectivity of the mirror coating then increases toward the upper and side regions of the lens 1003 where the transmissivity is less. Thus, the mirror coating provides a baseline level of reflectivity over the lens 1003, with increased reflectivity in certain regions, rather than providing a mirror coating over a portion of the lens 1003 only. In another embodiment, a similar effect is achieved by treating the lens 1003 with a tint. The tint can be applied over substantially the entire lens 1003 to provide a non-zero baseline level of absorptivity, with increased absorptivity in certain regions of the lens 1003. For example, the tint can be configured to provide increased absorptivity in the upper and side regions of the lens 1003 to attenuate the transmission of light through the lens 1003 in those areas.

[0098] In some embodiments, the baseline amount of attenuation in the transmissivity of the lens 1003 is provided by a first optical treatment, while increased attenuation in certain regions of the lens 1003 is provided by a second optical treatment. Each optical treatment can be substantially neutral density, or can spectrally filter incident light as described above. For example, a uniform tint can be applied to the lens 1003 to provide a baseline amount of decreased transmissivity of the lens. A non-uniform partially transmissive mirror coating can then be applied to decrease the transmissivity of the lens in certain regions more than in others.

[0099] In one embodiment, the tint acts as a spectral filter that tends to balance the spectrum of fluorescent or incandescent lighting in an office environment, as described herein. The tint can be substantially uniform so as to establish a baseline decrease in the transmission of light through the lens 1003 over substantially its entire surface. A mirror coating can then be used to provide spatial filtering of incident light to reduce glare from, for

example, overhead lighting. In another embodiment, the roles of the tint and the mirror coating are reversed such that the mirror coating is applied to the lens 1003 to provide a baseline reduction in the transmissivity of the lens 1003, while the tint is applied to provide spatial filtering of incident light. Other designs are also possible.

[0100] It should be understood that, while FIG. 10 illustrates embodiments where a baseline reduction in the transmissivity of the lens 1003 is provided along with increased reductions to the transmissivity of the lens in the upper and side regions, in other embodiments other regions of the lens 1003 can have increased attenuation beyond the baseline level. Furthermore, the attenuation of the transmissivity of the lens 1003 can vary smoothly (whether monotonically or not), as roughly illustrated by the shading on lens 1003, or discontinuously.

[0101] In addition to providing optical treatments to selectively attenuate the transmission of light through various regions of a lens, some embodiments include optical treatments for selectively altering the amount of light that is reflected from a surface of a lens. For example, an optical treatment can be provided that selectively reduces the amount of light that originates generally from beside and behind a user that is reflected from the ocular curve of a lens into the eyes. One such embodiment is illustrated in FIG. 11.

[0102] FIG. 11 illustrates another embodiment of an optical treatment 1100 for performing spatial filtering of light incident upon a lens 1103. In this embodiment, the optical treatment 1100 is an AR coating applied to the ocular curve, or eye-side surface, of the lens 1103, though in some embodiments it is a partially transmissive mirror coating or tint applied to either the base or ocular curve. As in FIGS. 8-10, the lens 1103 includes a center region 1101 and peripheral regions. The peripheral regions include an upper region, a lower region, and first and second side regions.

[0103] Point A is located in the vicinity of the upper region of the lens 1103, while point B is located in the vicinity of the lower region of the lens 1103. The curve 1152 of the graph 1150 shows reflection of light from the lens 1103 as a function of position along the line AB. Likewise, the curve 1158 of the graph 1156 shows reflection of light from the lens 1103 as a function of position along the line CD. In this embodiment, the AR coating is configured such that the reflectivity of the lens 1103 is lesser in the periphery regions than in

the middle region. In fact, the reflectivity of the lens decreases smoothly from the middle region of the lens, represented on the graphs 1150 and 1156 as the portion between points A and B and between points C and D, though in other embodiments the reflectivity may vary discontinuously.

**[0104]** Thus, FIG. 11 illustrates an embodiment where the characteristics of the optical treatment vary according to a gradient extending radially from a center location. In particular, FIG. 11 illustrates an optical treatment with an annular gradient. Contour lines of the gradient illustrated in FIG. 11 will generally have closed paths. In some embodiments, the contour lines of the gradient are substantially circular, though they could be elliptical or have any other closed path. In some embodiments, an optical treatment with this type of gradient is formed on a lens by patterning the gradient on a thin film and then laminating the thin film onto a surface of the lens. This thin film can be, for example, a tinting layer, a mirror coating layer, or an AR coating layer.

**[0105]** The AR coating represented by FIG. 11 is effective at reducing glare from light that originates generally from behind a user and is incident upon the ocular curve of the lens 1103. For example, in an office environment if a window is located behind the user, light from the window could reflect from the ocular side of the lens 1103 and into the user's eye, resulting in increased glare and associated symptoms of CVS. However, since the AR coating represented in FIG. 11 is located on the ocular curve of the lens 1103, it is effective at decreasing glare from lighting that originates generally behind the user but that is not blocked by the user's head. The AR coating can be configured to decrease the reflectivity of the lens 1103 more substantially in the peripheral regions of the lens than in the middle region since light that reflects from the middle region of the ocular side of the lens 1103 is less likely to be re-directed into the user's eyes. In other embodiments, the AR coating may be substantially uniform over the surface of the ocular side of the lens 1103. In some embodiments, an AR coating can also be formed on the base side of the lens 1103.

**[0106]** Various embodiments of improved computer eyewear have been disclosed herein. In some embodiments, the embodiments of computer eyewear are off-the-shelf, non-prescription eyewear. Since the computer eyewear is non-prescription eyewear, it can be mass manufactured without knowledge of the optometric prescriptions of the end-users for



which the eyewear is intended. Once manufactured, sets of the computer eyewear can be packaged together for shipping to retailers. A package can include multiple sets of the eyewear with identical optical power, or sets of computer eyewear with several different amounts of optical power. For example, the package could include three or more pairs of eyewear, though the number can vary. The computer eyewear can also be packaged as part of a kit that also includes instructions for proper usage of the eyewear. For example, the instructions can direct the user to view a computer screen with the eyewear. The kit can also include removable side-shields for use with the eyewear.

[0107] While certain embodiments of computer eyewear have been explicitly described herein, other embodiments will become apparent to those of ordinary skill in the art based on this disclosure. Therefore, the scope of the inventions is intended to be defined by reference to the claims and not simply with regard to the explicitly described embodiments. Furthermore, while some embodiments have been described in connection with the accompanying drawings, a wide variety of variation is possible. For example, components, and/or elements may be added, removed, or rearranged.

WHAT IS CLAIMED IS:

1. Stock computer eyewear comprising:  
first and second lens portions each having optical power in the range between about +0.5 to +2.5 diopters, said first and second lens portions having substantially identical optical power to provide off-the-shelf correction for a user having substantially normal uncorrected or spectacle vision when viewing a computer screen, each lens portion having a base curve and an ocular curve; and  
a frame portion disposed about said first and second lens portions to provide support,  
wherein said base curve of said first and second lens portions includes a partially transmissive mirror coating thereon.
2. The stock computer eyewear of Claim 1, wherein said lens portions comprise plastic.
3. The stock computer eyewear of Claim 1, wherein said first and second lens portions comprises first and second lenses, and said frame comprises generally round enclosures into which said lenses fit.
4. The stock computer eyewear of Claim 1, wherein said first and second lens portions comprise a unitary body.
5. The stock computer eyewear of Claim 1, wherein said mirror coating comprises metallization.
6. The stock computer eyewear of Claim 1, wherein said mirror coating is at least 15% reflective over at least a portion of a 340-780 nm wavelength band.
7. The stock computer eyewear of Claim 1, wherein said mirror coating is non-uniform across said first and second lens portions.
8. The stock computer eyewear of Claim 7, wherein said mirror coating has a higher reflectivity in peripheral regions of said lens portions in comparison to central regions of said lens portions.
9. The stock computer eyewear of Claim 8, wherein said peripheral regions have a reflectivity that is at least about 20% higher than in said central regions.

10. The stock computer eyewear of Claim 7, wherein said lens portions have upper regions, side regions, central regions, and lower regions, said mirror coating having a higher reflectivity in said upper regions and side regions than in said central regions.

11. The stock computer eyewear of Claim 10, further comprising a nosepiece, said lower regions being closer to said nosepiece than said upper regions.

12. The stock computer eyewear of Claim 1, wherein said mirror coating comprises a spectral filter that filters at least one band of wavelengths in the visible range.

13. The stock computer eyewear of Claim 12, wherein said spectral filter includes at least one stop band in the visible spectrum that coincides with a spectral peak in the emission of incandescent or fluorescent lighting such that transmission of said spectral peak through said mirror coating is selectively attenuated.

14. The stock computer eyewear of Claim 13, wherein said stop band reduces transmission by at least about 50% over a band between about 25 and 150 nanometers wide in the visible spectrum.

15. The stock computer eyewear of Claim 12, wherein said spectral filter comprises a high pass, a low pass, or a bandpass filter.

16. The stock computer eyewear of Claim 1, wherein said lens portions further comprises light absorbing tinting.

17. The stock computer eyewear of Claim 16, wherein said light absorbing tinting comprises pigments, non-photoreactive dyes, photoreactive dyes, or optically absorptive layers.

18. The stock computer eyewear of Claim 16, wherein said mirror coating is non-uniform and said light absorbing tinting is substantially uniform across said first and second lens portions.

19. The stock computer eyewear of Claim 16, wherein said mirror coating is substantially uniform and said light absorbing tinting is non-uniform across said first and second lens portions.

20. The stock computer eyewear of Claim 16, wherein said light absorbing tinting is non-uniform across said first and second lens portions.

21. The stock computer eyewear of Claim 20, wherein said light absorbing tinting is more absorptive in peripheral regions of said lens portions than in central regions of said lens portions.

22. The stock computer eyewear of Claim 21, wherein said peripheral regions are at least about 20% more absorptive than said central regions.

23. The stock computer eyewear of Claim 20, wherein said lens portions have upper regions, side regions, central regions, and lower regions, and said light absorbing tinting is more absorptive in said upper regions and side regions than in said central regions.

24. The stock computer eyewear of Claim 23, further comprising a nosepiece, said lower regions being closer to said nosepiece than said upper regions.

25. The stock computer eyewear of Claim 16, wherein said light absorbing tinting comprises a spectral filter in the visible wavelengths.

26. The stock computer eyewear of Claim 25, wherein said spectral filter includes at least one stop band in the visible spectrum that coincides with a spectral peak in the emission of incandescent or fluorescent lighting such that transmission of said spectral peak through said tinting is selectively attenuated.

27. The stock computer eyewear of Claim 26, wherein said stop band reduces transmission by at least about 50% over a band between about 25 and 150 nanometers wide in the visible spectrum.

28. The stock computer eyewear of Claim 25, wherein said spectral filter comprises a high pass, a low pass, or a bandpass filter.

29. The stock computer eyewear of Claim 1, wherein said ocular curve of said first and second lens portions includes an anti-reflective coating thereon.

30. The stock computer eyewear of Claim 29, wherein said anti-reflective coating comprises a thin-film coating.

31. The stock computer eyewear of Claim 29, wherein said lens portions treated with the anti-reflective coating have reduced reflectivity in peripheral regions compared to central regions of the lens portions.

32. The stock computer eyewear of Claim 1, wherein said frame portion comprises aluminum, magnesium, titanium, or any alloy or combination of these metals.

33. The stock computer eyewear of Claim 1, wherein said lens portions comprise non-progressive lenses.

34. The stock computer eyewear of Claim 1, wherein said lens portions include prismatic power.

35. A method of mitigating symptoms of computer vision syndrome when viewing a computer screen, said method comprising:

disposing first and second lens portions in front of eyes having substantially normal uncorrected or spectacle vision, each lens portion having substantially identical optical power in the range between about +0.5 to +2.5 diopters, each lens portion having a partially transmissive mirror coating thereon; and

viewing said computer screen through said first and second lens portions.

36. The method of Claim 35, wherein said computer screen is viewed indoors.

37. A kit for mitigating symptoms of computer vision syndrome when viewing a computer screen, said kit comprising:

eyewear comprising first and second non-progressive lens portions, each lens portion having substantially identical optical power in the range between about +0.5 to +2.5 diopters, each lens portion having a partially transmissive mirror coating thereon; and

information directing a user to wear said eyewear when viewing a computer screen.

38. The computer eyewear of Claim 37, wherein said information is included on or in packaging for said eyewear.

39. A kit comprising:

a package of three or more pairs of computer eyeglasses, said computer eyeglasses comprising,

first and second lens portions each having optical power in the range between about +0.5 to +2.5 diopters, said first and second lens portions having substantially identical optical power to provide non-prescription correction for viewing a computer screen; and

a frame portion disposed about said first and second lens portions to provide support,

wherein said first and second lens portions include a partially reflective mirror coating thereon.

40. The kit of Claim 39 wherein said three or more pairs of computer eyeglasses have substantially identical optical power.

41. The kit of Claim 39, wherein said three or more pairs of computer eyeglasses have different optical power.

42. The kit of Claim 41, wherein said package includes computer eyeglasses selected from at least two of the following groups:

eyeglasses having optical power in the range of about +.5 to less than +.75 diopters;

eyeglasses having optical power in the range of about +.75 to less than +1.0 diopters;

eyeglasses having optical power in the range of about +1.0 to less than +1.25 diopters;

eyeglasses having optical power in the range of about +1.25 to less than +1.50 diopters;

eyeglasses having optical power in the range of about +1.50 to less than +1.75 diopters

eyeglasses having optical power in the range of about +1.75 to less than +2.0 diopters;

eyeglasses having optical power in the range of about +2.0 to less than +2.25 diopters; or

eyeglasses having optical power in the range of about +2.25 to less than +2.50 diopters.

43. A method of mass manufacturing computer eyewear, comprising:

without knowing the prescription of a user, producing a plurality of eyewear, each of said eyewear produced by combining left and right lens portions having optical power in the range between about +0.5 to +2.5 diopters, said left and right lens

portions having substantially identical optical power to provide non-prescription correction for left or right eyes for viewing a computer screen,

wherein said left and right lens portions have a partially transmissive mirror coating.

44. Computer eyewear comprising:

first and second lens portions with substantially equal optical power in the range between about +0.5 to +2.5 diopters, said first and second lens portions having substantially identical optical power to provide non-prescription correction for viewing a computer screen; and

a frame portion disposed about said first and second lens portions to provide support,

wherein said first and second lens portions include an optical filter having at least one stop band in the visible spectrum that coincides with a spectral peak in the emission of incandescent or fluorescent lighting such that transmission of said spectral peak through said filter is selectively attenuated.

45. The computer eyewear of Claim 44, wherein said optical filter comprises a partially transmissive mirror coating, light absorbing tinting, or a combination of the two.

46. The computer eyewear of Claim 44, wherein said stop band reduces transmission by at least about 50% over a band between about 25 and 150 nanometers wide in the visible spectrum.

47. The computer eyewear of Claim 44, wherein said spectral filter comprises a high pass, a low pass, or a band pass filter.

48. A method of mass manufacturing computer eyewear, comprising:

without knowing the prescription of a user, producing first and second lens portions with substantially equal optical power in the range between about +0.5 to +2.5 diopters, said first and second lens portions having substantially identical optical power to provide non-prescription correction for viewing a computer screen,

wherein said lens portions include a spectral optical filter having at least one stop band in the visible spectrum that coincides with a spectral peak in the emission

of incandescent or fluorescent lighting such that transmission of said spectral peak through said filter is selectively attenuated.

49. A method of mitigating symptoms of computer vision syndrome when viewing a computer screen, said method comprising:

disposing first and second lens portions in front of eyes having substantially normal uncorrected or spectacle vision, each lens portion having substantially identical optical power in the range between about +0.5 to +2.5 diopters, each lens portion having a partially transmissive mirror coating thereon, said mirror coating comprising a spectral optical filter having at least one stop band in the visible spectrum that coincides with a spectral peak in the emission of incandescent or fluorescent lighting such that transmission of said spectral peak through said mirror coating is selectively attenuated; and

viewing said computer screen through said first and second lens portions.

50. Computer eyewear comprising:

first and second lens portions each having optical power in the range between about +0.5 to +2.5 diopters, said first and second lens portions having substantially identical optical power to provide non-prescription correction for viewing a computer screen;

a frame portion disposed about said first and second lens portions to provide support; and

a plurality of side-shields which are removably attached to said eyewear and are configured to at least partially block light and air flow.

51. The computer eyewear of Claim 51, wherein the percent relative humidity in the vicinity of a user's eyes while wearing said computer eyewear with said removable side-shields attached to said eyewear is at least about 40%.

52. The computer eyewear of Claim 50, wherein said detachable shields are attachable to said eyewear via snap-on fasteners or magnetic fasteners.

53. The computer eyewear of Claim 50, wherein said detachable shields are substantially opaque.



54. The computer eyewear of Claim 50, wherein said detachable shields comprise plastic.

55. The computer eyewear of Claim 50, wherein said lens portions include one or more edges which complementarily follow contours of a user's face.

56. A kit comprising:

computer eyewear comprising,

first and second lens portions each having optical power in the range between about +0.5 to +2.5 diopters, said first and second lens portions having substantially identical optical power to provide non-prescription correction for viewing a computer screen, and

a frame portion disposed about said first and second lens portions to provide support; and

a plurality of side-shields which are detachable from the eyewear and are configured to block light and air flow.

57. Non-prescription computer eyewear comprising:

first and second lens portions having optical power in the range between about +0.5 to +2.5 diopters, said first and second lens portions having substantially identical optical power to provide off-the-shelf correction for a user having substantially normal uncorrected or spectacle vision when viewing a computer screen, each lens portion having a peripheral region and a central region; and

a frame portion disposed about said first and second lens portions to provide support,

wherein said first and second lens portions have a transmissivity that varies smoothly from said peripheral regions to said central regions.

58. The computer eyewear of Claim 57, wherein said transmissivity is higher in said central regions than in said peripheral regions.

59. The computer eyewear of Claim 57, wherein said first and second lens portions include a partially transmissive mirror coating and the reflectivity of said mirror coating varies smoothly from said peripheral regions to said central regions.

60. The computer eyewear of Claim 57, wherein said first and second lens portions include light absorbing tinting and the absorptivity of said tinting varies smoothly from said peripheral regions to said central regions.

61. The computer eyewear of Claim 57, wherein said first and second lens portions include a partially transmissive mirror coating and light absorbing tinting, and wherein the reflectivity of the mirror coating or the absorptivity of the tinting is non uniform.

62. Non-prescription computer eyewear comprising:

first and second lenses having optical power in the range between about +0.5 to +2.5 diopters, said first and second lenses having substantially identical optical power to provide non-prescription correction for viewing a computer screen; and

a frame portion disposed about said first and second lenses to provide support, wherein said first and second lenses include light absorbing tinting, the absorptivity of which substantially varies, said tinting covering at least 90% of said lenses.

63. Non-prescription computer eyewear comprising:

first and second lenses having optical power in the range between about +0.5 to +2.5 diopters, said first and second lenses having substantially identical optical power to provide off-the-shelf correction for a user having substantially normal uncorrected or spectacle vision when viewing a computer screen; and

a frame portion disposed about said first and second lenses to provide support, wherein said first and second lenses include light absorbing tinting, the absorptivity of which varies between a non-zero baseline lower level and an upper level.

64. The non-prescription computer eyewear of Claim 63, wherein a region of each of said lenses is tinted at said non-zero baseline level, a region of said lenses is tinted at an intermediate level, and a region of said lenses is tinted at the upper level.

65. Stock computer eyewear comprising:

a first lens having a first geometric center and a first optical center offset from the first geometric center; and

a second lens having a second geometric center and a second optical center offset from the second geometric center,

wherein said first and second lenses have substantially identical optical power in the range between about +0.5 to +2.5 diopters to provide off-the-shelf correction for a user having normal uncorrected or spectacle vision when viewing a computer screen.

66. The stock computer eyewear of Claim 65, wherein said first and second optical centers are offset medially from said first and second geometric centers, respectively.

67. The stock computer eyewear of Claim 66, wherein said first and second optical centers are offset upward, toward a user's brow, from said first and second geometric centers, respectively.

68. The stock computer eyewear of Claim 65, wherein said eyewear has a base curvature of at least base six.

69. Stock computer eyewear comprising:

a first lens having a first lateral edge and a first medial edge, the first lens having a greater thickness at the first medial edge than at the first lateral edge; and

a second lens having a second lateral edge and a second medial edge, the second lens having a greater thickness at the second medial edge than at the second lateral edge,

wherein said first and second lenses have substantially identical optical power in the range between about +0.5 to +2.5 diopters to provide off-the-shelf correction for a user having normal uncorrected or spectacle vision when viewing a computer screen.

70. The stock computer eyewear of Claim 69, wherein said first and second lenses have top and bottom edges, each of said first and second lenses having a greater thickness at the top edge than at the bottom edge.

71. The stock computer eyewear of Claim 69, wherein said first and second lenses include at least .25 prism diopters of base-in prismatic power.

72. The stock computer eyewear of Claim 69, wherein said first and second lenses have a partially transmissive coating deposited thereon.

73. The stock computer eyewear of Claim 69, wherein said eyewear has a base curvature of at least base six.

74. Stock computer eyewear comprising:

first and second lenses each having optical power in the range between about +0.5 to +2.5 diopters, said first and second lenses having substantially identical optical power to provide off-the-shelf correction for a user having normal uncorrected or spectacle vision when viewing a computer screen, each lens having a base curve and an ocular curve; and

a frame portion disposed about said first and second lens portions to provide support,

wherein said eyewear has a base curvature of at least base six.

75. The stock computer eyewear of Claim 74, wherein said eyewear has an amount of pantoscopic tilt.

76. The stock computer eyewear of Claim 74, wherein said eyewear has a base curvature of at least base eight.

77. The stock computer eyewear of Claim 74, wherein said eyewear has a base curvature of at least base ten.

78. The stock computer eyewear of Claim 74, wherein said first and second lenses include at least .25 prism diopters of base-in prismatic power.

79. The stock computer eyewear of Claim 74, wherein said first and second lenses comprise first and second decentered lenses.

80. The stock computer eyewear of Claim 74, wherein a ratio of a transverse measurement,  $d_1$ , of said first and second lenses to a depth measurement,  $d_2$ , of said first and second lenses is approximately 1.5-3.5.

81. The stock computer eyewear of Claim 74, wherein said wrap-around design maintains the percent relative humidity of air in the vicinity of the eyes at about 40% or higher.

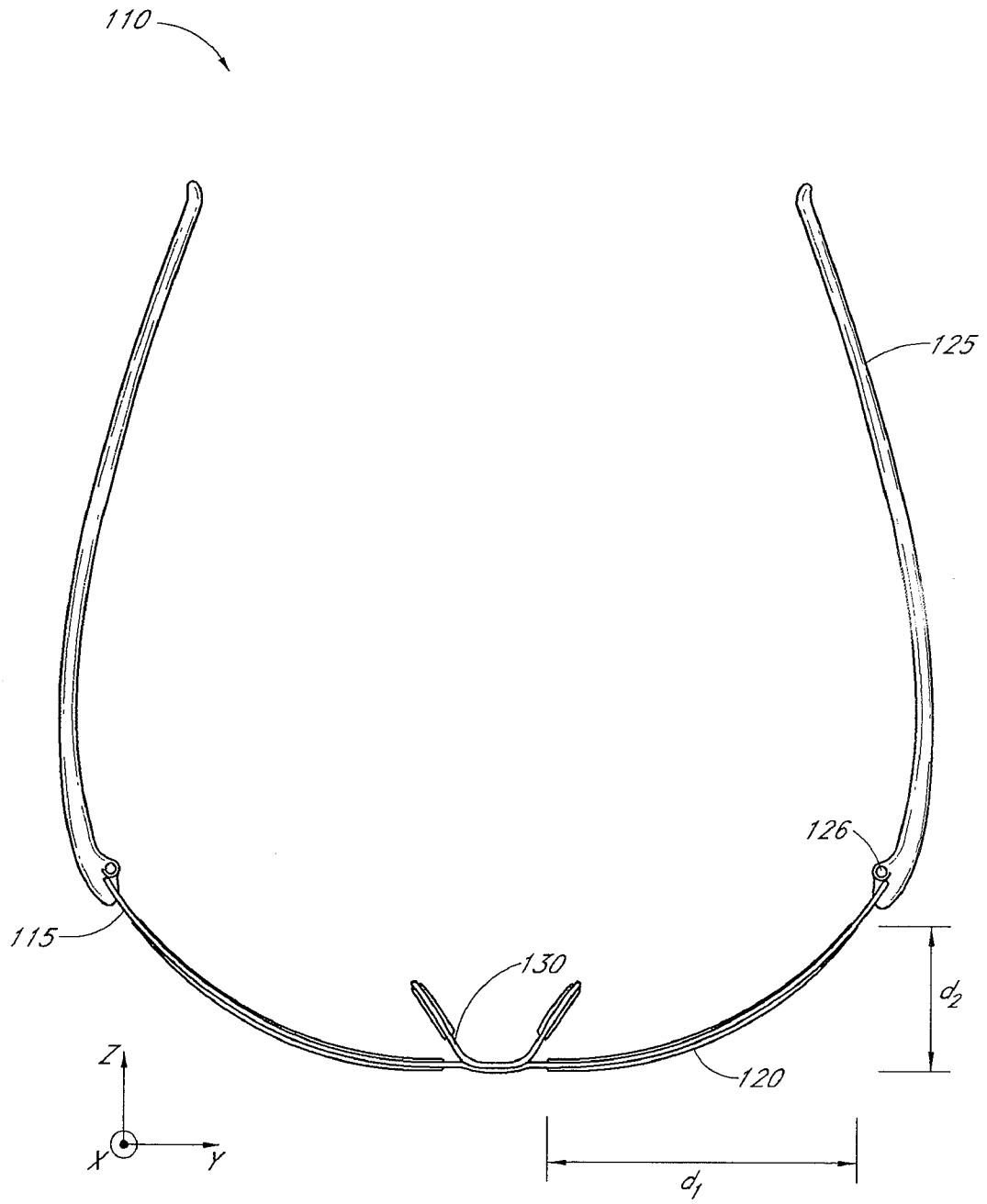
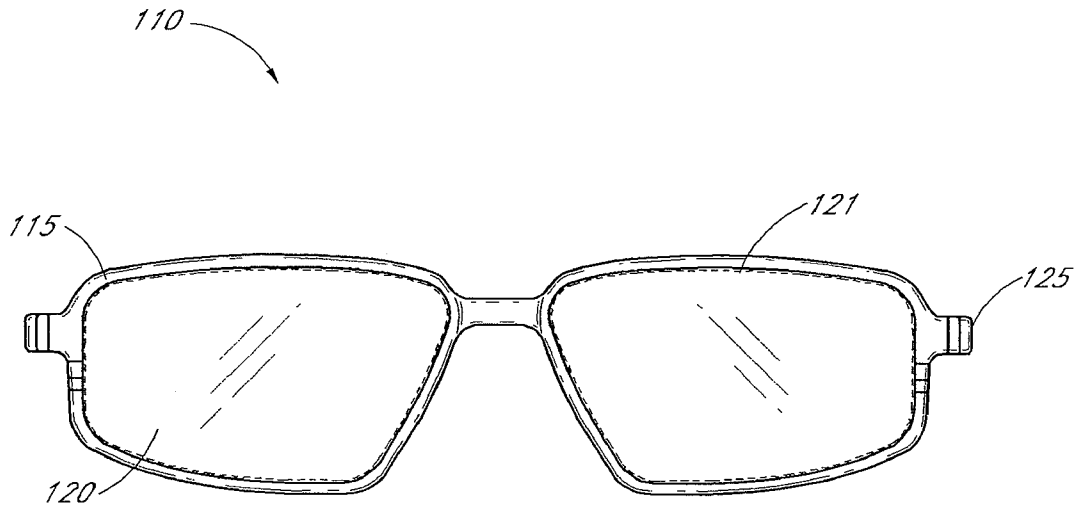
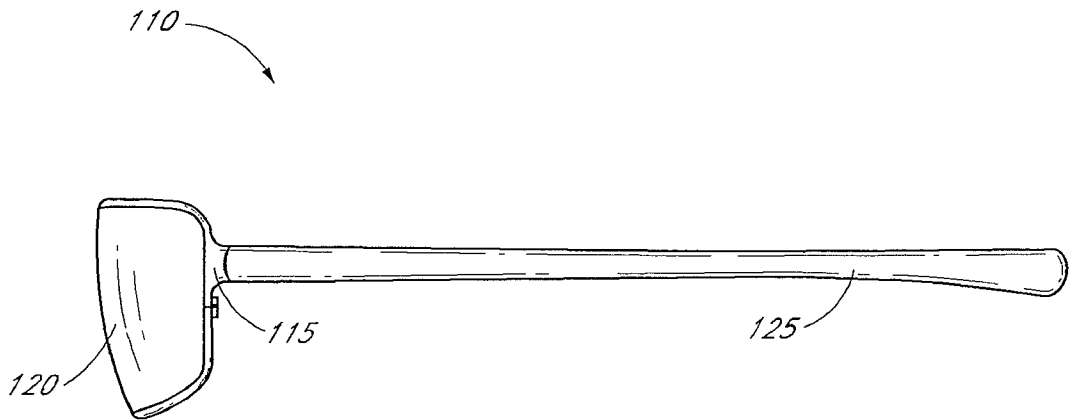

FIG. 1



*FIG. 2*



*FIG. 3*

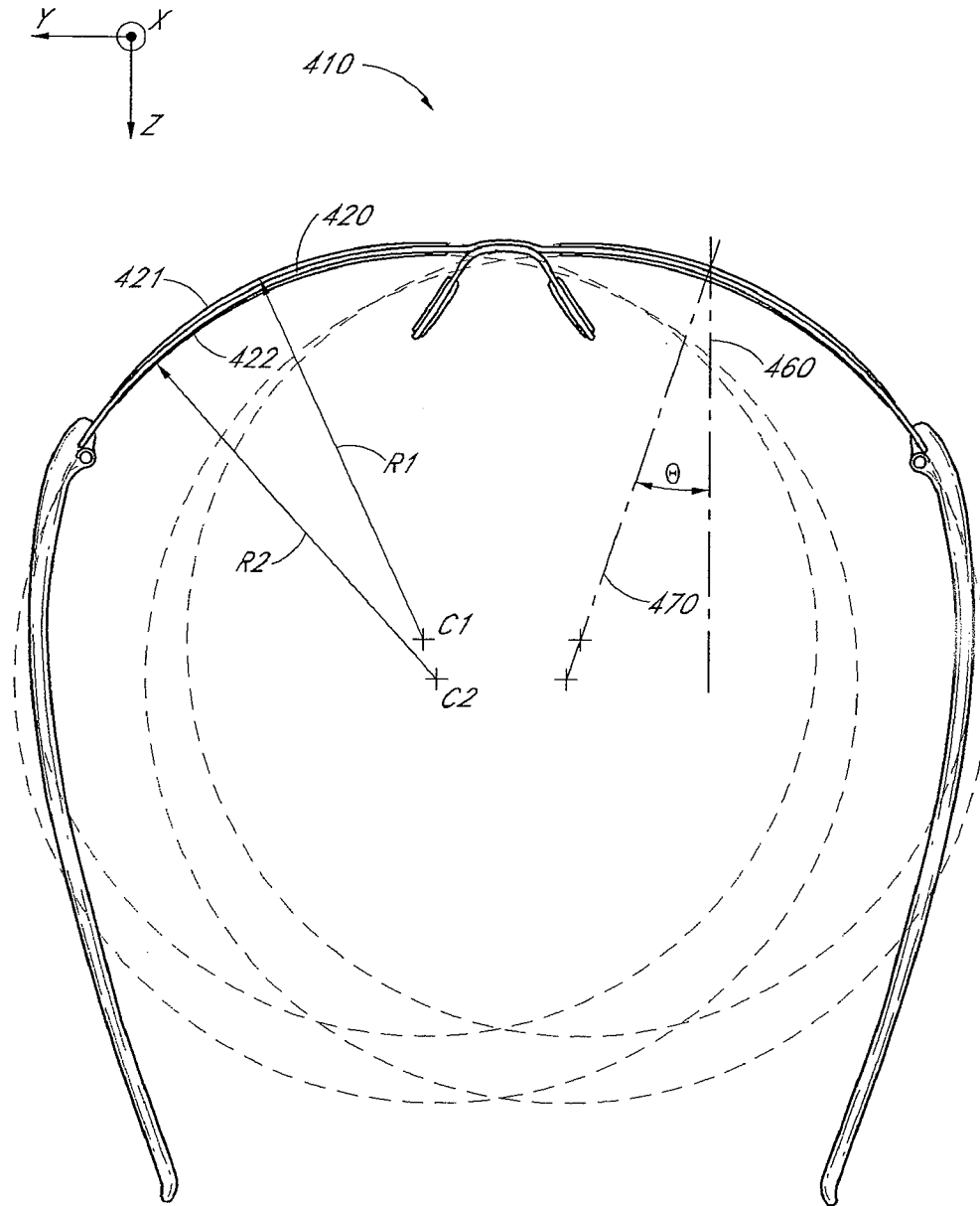

FIG. 4

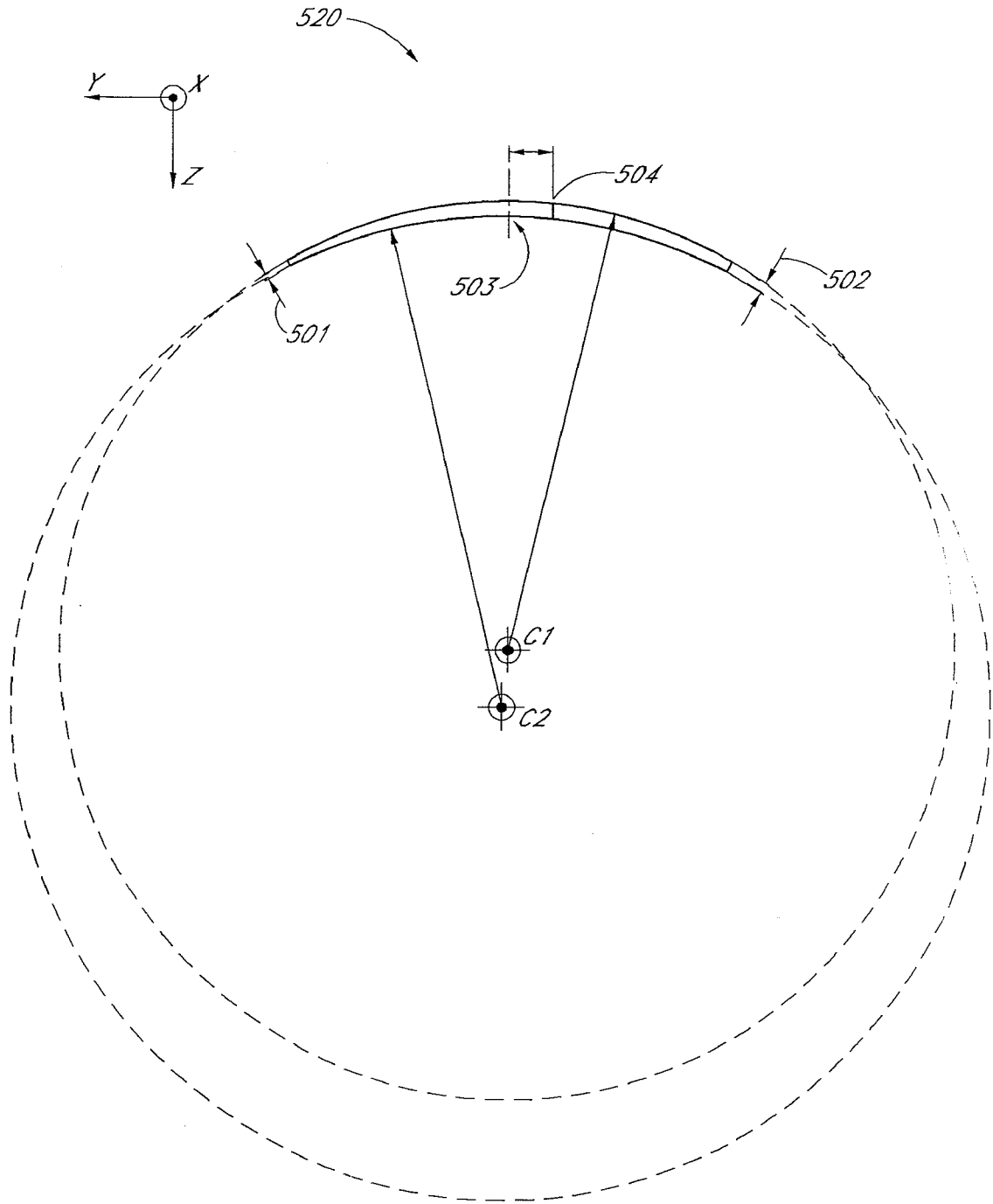

FIG. 5



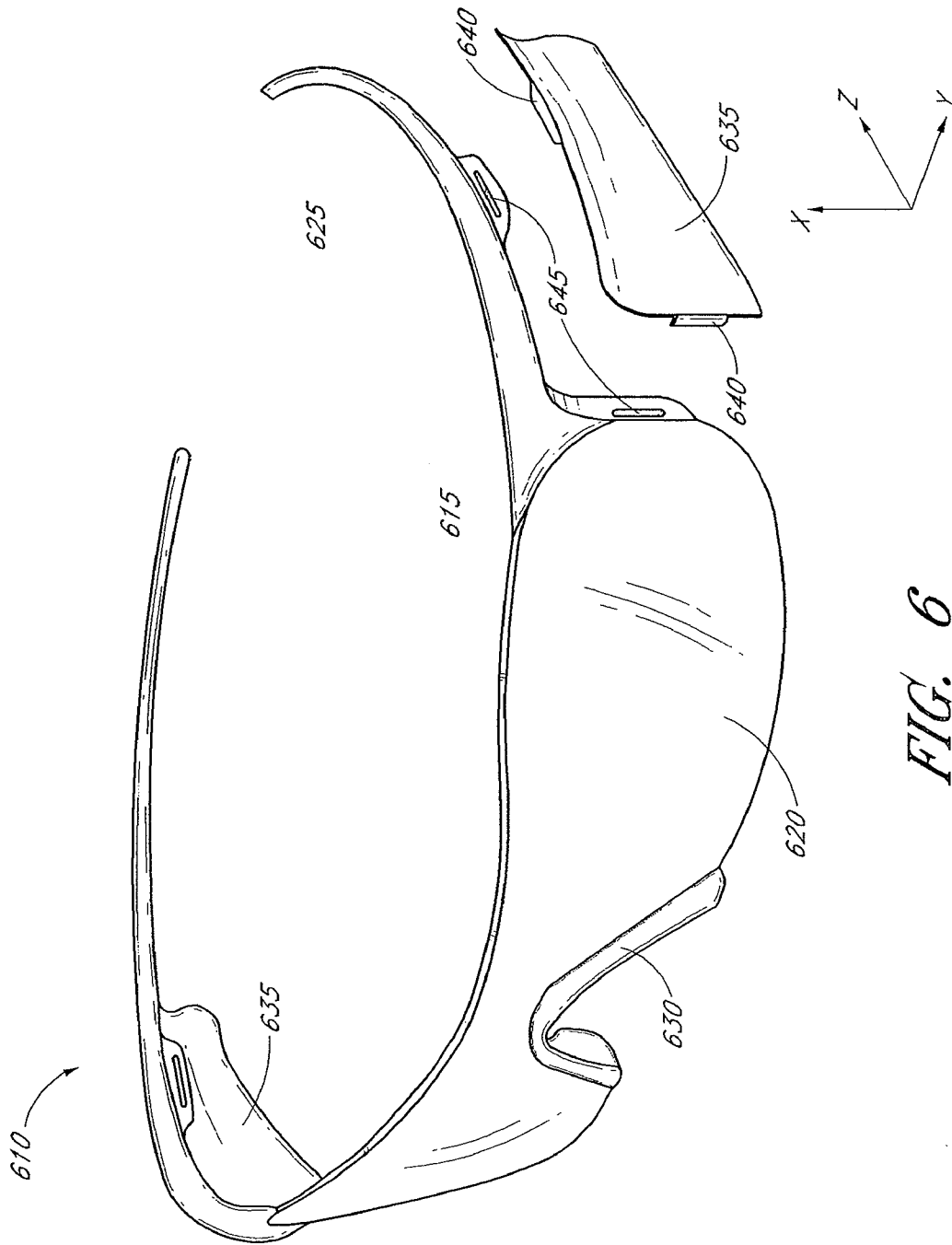

FIG. 6

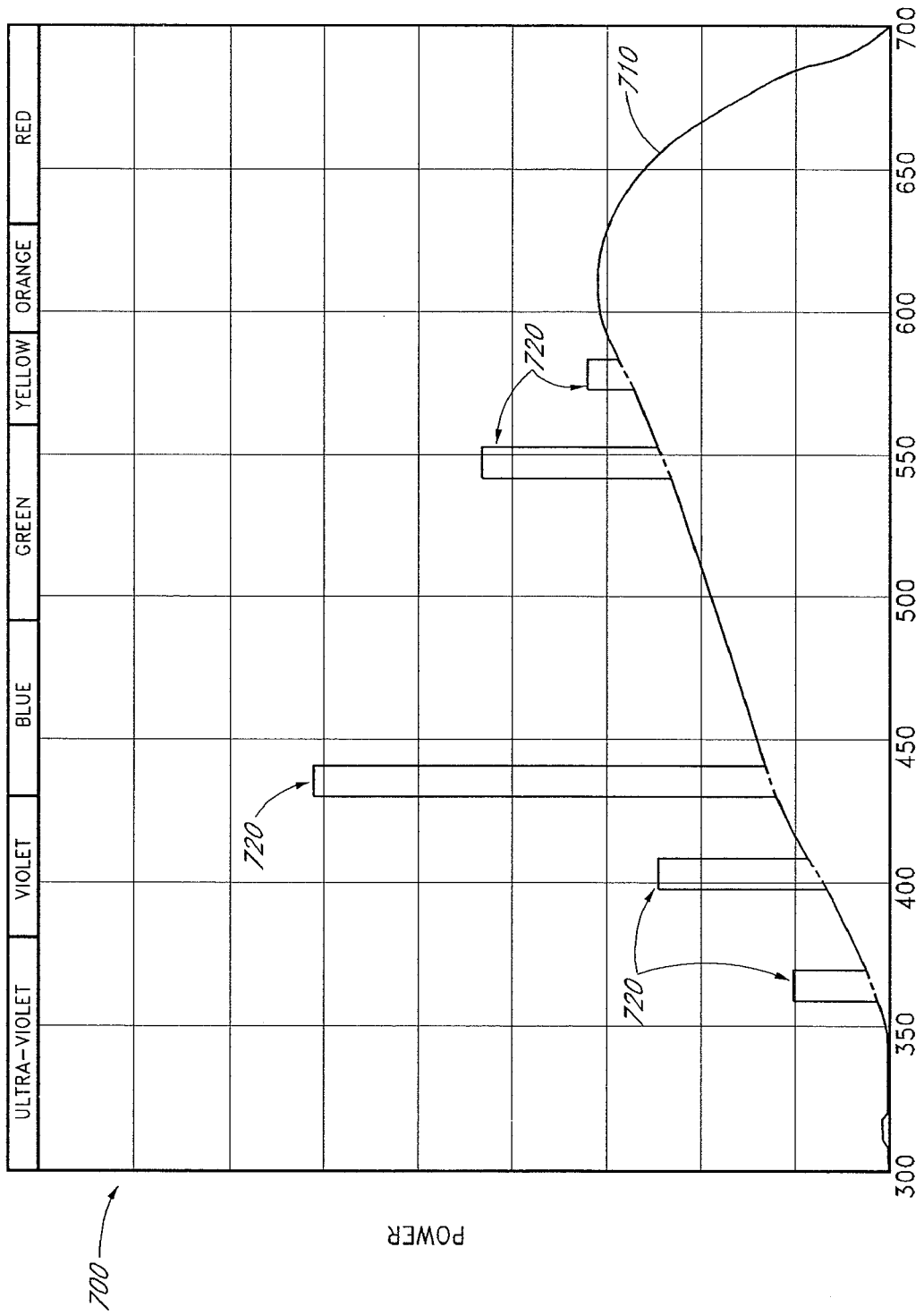

FIG. 7

WAVELENGTH IN NANOMETERS

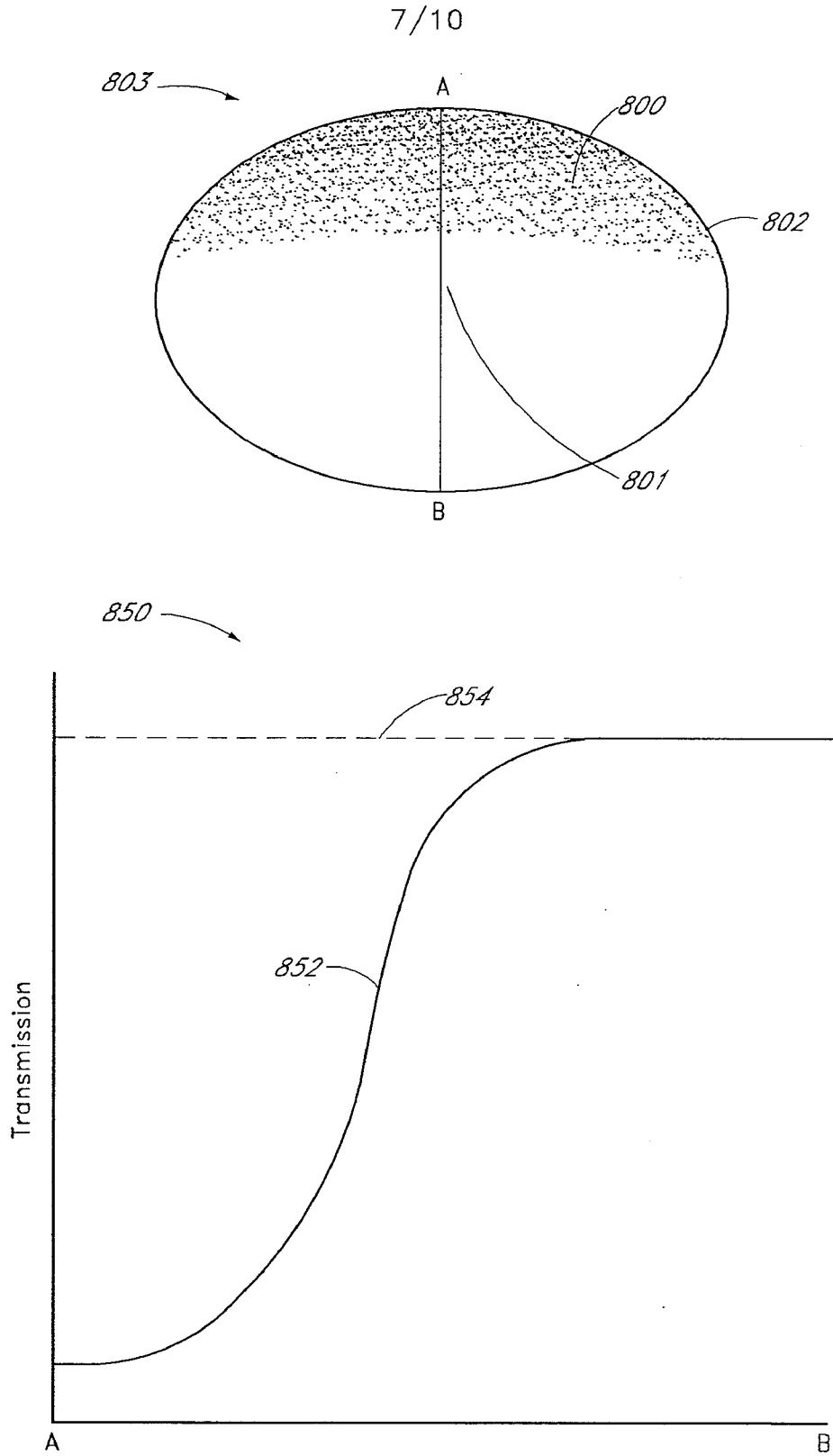

FIG. 8

8/10

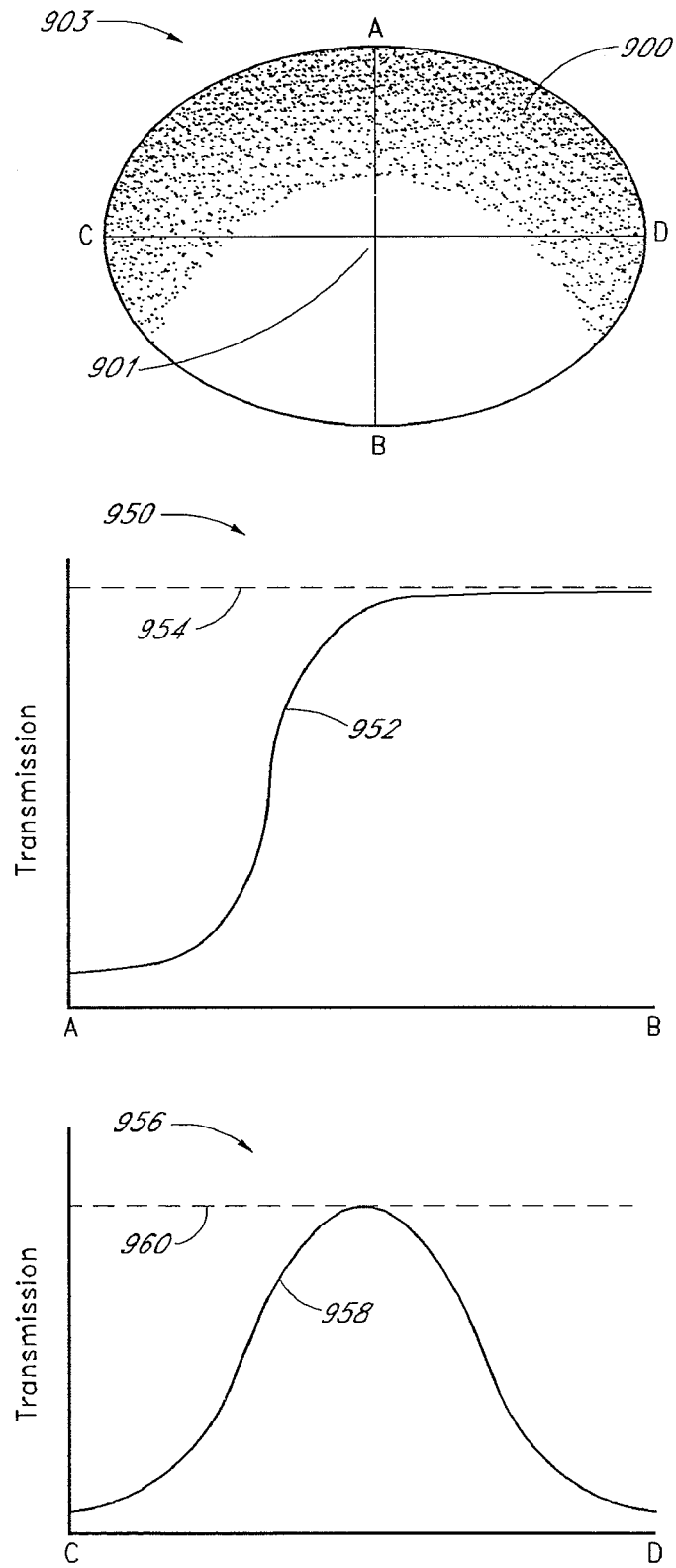

FIG. 9

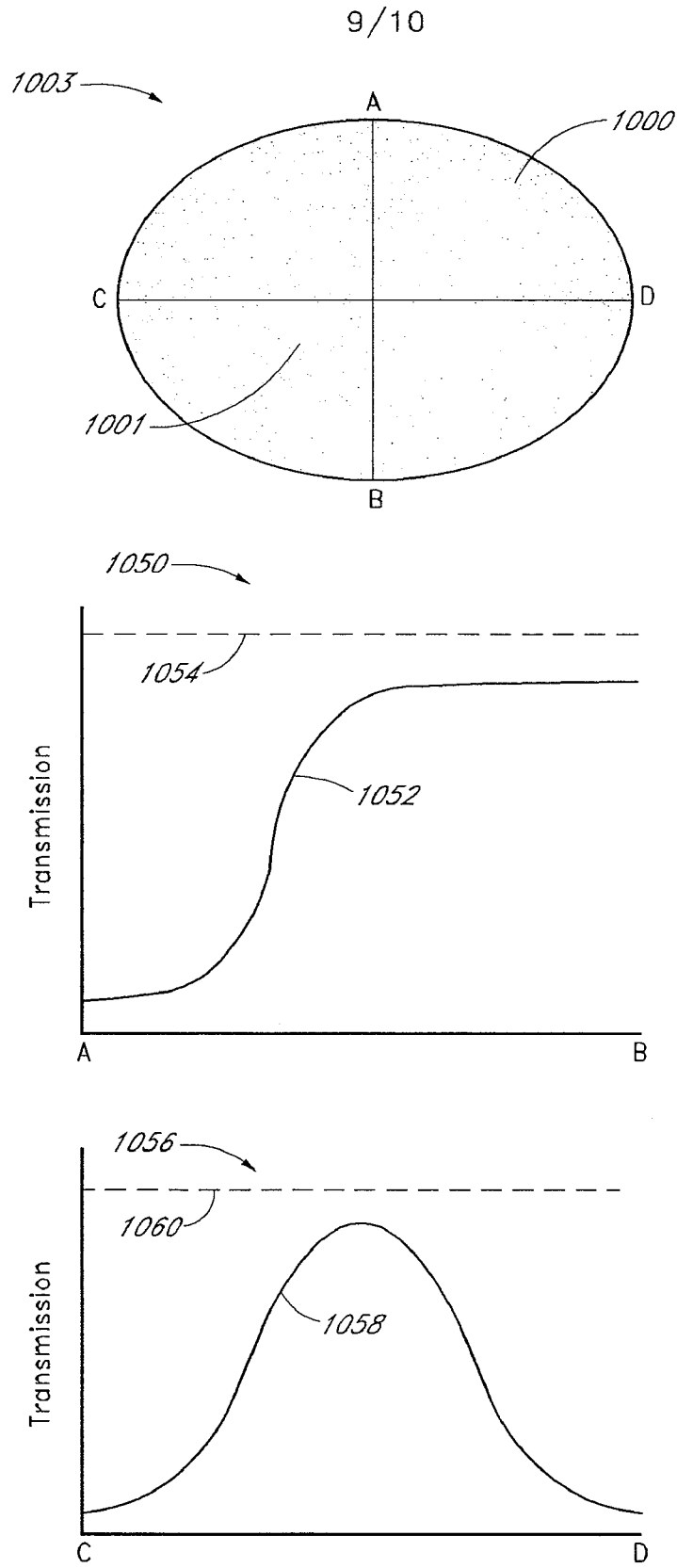

FIG. 10

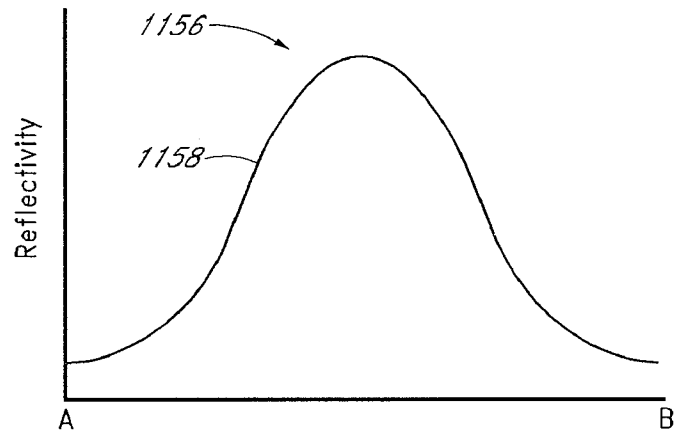
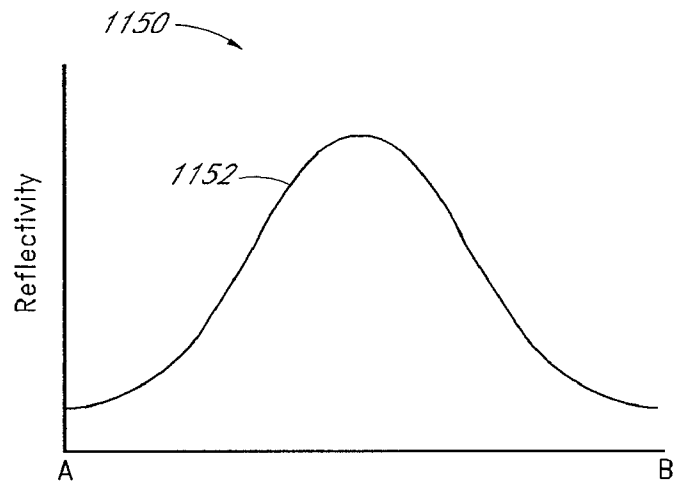
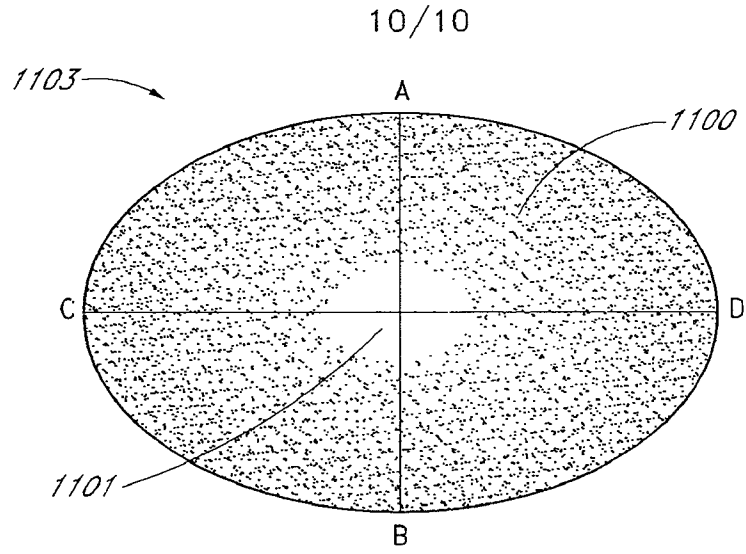

FIG. 11

**INTERNATIONAL SEARCH REPORT**

International application No.

PCT/US2008/062691

**A. CLASSIFICATION OF SUBJECT MATTER**

IPC(8) - G02C 7/10 (2008.04)

USPC - 351/163

According to International Patent Classification (IPC) or to both national classification and IPC

**B. FIELDS SEARCHED**

Minimum documentation searched (classification system followed by classification symbols)

IPC(8) - G02C 7/10 (2008.04)

USPC - 351/163

Documentation searched other than minimum documentation to the extent that such documents are included in the fields searched

USPC - 351/44-49, 351/158-159; 2/428, 351/\$ and unrestricted key word searches

Electronic data base consulted during the international search (name of data base and, where practicable, search terms used)

USPTO WEST System (US, USPG-PUB, EPO)

**C. DOCUMENTS CONSIDERED TO BE RELEVANT**

Category*	Citation of document, with indication, where appropriate, of the relevant passages	Relevant to claim No.
X --- Y	US 2006/0055878 A1 (Yee) 16 March 2006 (16.03.2006) entire document.	1-4, 12, 16-17, 25, 33-35, 39-43, 50-56, 63 --- 5-11, 13-15, 18-24, 26-32, 36-38, 44-49, 57-62, 64-81
Y	US 2005/0179859 A1 (Perrott et al) 18 August 2004 (18.08.2005) entire document.	5, 65-81
Y	US 2006/0146275 A1 (Mertz) 6 July 2006 (6.07.2006) entire document.	6-11, 13-15, 18-24, 26-28, 31, 36, 44-49, 57-62, 64
Y	US 2005/0099589 A1 (Ishak) 12 May 2005 (12.05.2005) entire document.	29-31
Y	US 6,386,701 B1 (Khulusi) 14 May 2002 (14.05.2002) entire document.	32
Y	US 5,848,700 A (Horn) 15 December 1998 (15.12.1998) entire document.	37-38

Further documents are listed in the continuation of Box C.

* Special categories of cited documents:	"T" later document published after the international filing date or priority date and not in conflict with the application but cited to understand the principle or theory underlying the invention
"A" document defining the general state of the art which is not considered to be of particular relevance	"X" document of particular relevance; the claimed invention cannot be considered novel or cannot be considered to involve an inventive step when the document is taken alone
"E" earlier application or patent but published on or after the international filing date	"Y" document of particular relevance; the claimed invention cannot be considered to involve an inventive step when the document is combined with one or more other such documents, such combination being obvious to a person skilled in the art
"L" document which may throw doubts on priority claim(s) or which is cited to establish the publication date of another citation or other special reason (as specified)	"&" document member of the same patent family
"O" document referring to an oral disclosure, use, exhibition or other means	
"P" document published prior to the international filing date but later than the priority date claimed	

Date of the actual completion of the international search

03 September 2008 (03.09.2008)

Date of mailing of the international search report

**09 SEP 2008**

Name and mailing address of the ISA/US

Mail Stop PCT, Attn: ISA/US, Commissioner for Patents  
P.O. Box 1450, Alexandria, Virginia 22313-1450  
Facsimile No. 571-273-3201

Authorized officer:

Blaine R. Copenheaver

PCT Helpdesk: 571-272-4300  
PCT OSP: 571-272-7774