



US00D998391S

(12) **United States Design Patent**
Dart et al.

(10) **Patent No.:** **US D998,391 S**

(45) **Date of Patent:** **** Sep. 12, 2023**

(54) **ADJUSTABLE SHELF**

DESCRIPTION

- (71) Applicant: **Dedee R. Dart**, Mapleton, UT (US)
- (72) Inventors: **Dedee R. Dart**, Mapleton, UT (US);
Bart Storrs, Highland, UT (US)
- (73) Assignee: **Edgy Shelf Products, LLC**, Mapleton,
UT (US)
- (**) Term: **15 Years**
- (21) Appl. No.: **29/870,626**
- (22) Filed: **Jan. 31, 2023**

Related U.S. Application Data

- (63) Continuation-in-part of application No. 29/821,065,
filed on Dec. 27, 2021, now Pat. No. Des. 976,623,
(Continued)
- (51) **LOC (14) Cl.** **06-06**
- (52) **U.S. Cl.**
USPC **D6/678**
- (58) **Field of Classification Search**
USPC D6/406.1-406.5, 654, 654.1, 678, 678.1,
D6/704, 705, 705.1, 707
(Continued)

References Cited

U.S. PATENT DOCUMENTS

- 4,713,949 A * 12/1987 Wilcox A47B 45/00
211/186
- 5,029,724 A * 7/1991 Serio B65D 55/14
292/205

(Continued)

Primary Examiner — Kelley A Donnelly

(74) *Attorney, Agent, or Firm* — Morriss O'Bryant
Compagni Cannon, PLLC

(57) **CLAIM**

The ornamental design for the adjustable shelf, as shown and described.

FIG. 1 is a perspective top front view of the adjustable shelf of the present invention in expanded form;
 FIG. 2 is a perspective bottom back view of the adjustable shelf in expanded form thereof;
 FIG. 3 is a front side view of the adjustable shelf in expanded form;
 FIG. 4 is a back side view of the adjustable shelf in expanded form;
 FIG. 5 is a left side view of the adjustable shelf in expanded form;
 FIG. 6 is a right side view of the adjustable shelf in expanded form;
 FIG. 7 is a top side view of the adjustable shelf in expanded form;
 FIG. 8 is a bottom side view of the adjustable shelf in expanded form;
 FIG. 9 is a right side view of the adjustable shelf in expanded form showing the location of the detailed view of the adjustable leg of FIG. 10;
 FIG. 10 is a detailed view of the adjustable shelf shown in FIG. 9;
 FIG. 11 is a perspective top back view of the adjustable shelf in collapsed form;
 FIG. 12 is a perspective bottom front view in expanded form;
 FIG. 13 is a front side view of the adjustable shelf in collapsed form;
 FIG. 14 is a back side view of the adjustable shelf in collapsed form;
 FIG. 15 is a left side view of the adjustable shelf in collapsed form;
 FIG. 16 is a right side view of the adjustable shelf in collapsed form;
 FIG. 17 is a top side view of the adjustable shelf in collapsed form;
 FIG. 18 is a bottom side view of the adjustable shelf in collapsed form;
 FIG. 19 is a right side view of the adjustable shelf in collapsed form showing the location of the detailed view of the adjustable leg of FIG. 20; and,
 FIG. 20 is a detailed view of the adjustable shelf shown in FIG. 19.

(Continued)

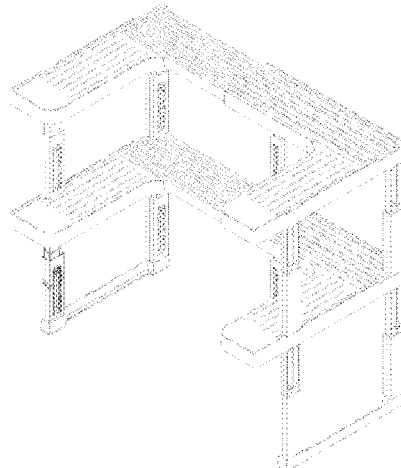

The broken lines illustrate portions of the adjustable shelf that form no part of the claimed design.

1 Claim, 20 Drawing Sheets

Related U.S. Application Data

which is a continuation of application No. 29/812, 120, filed on Oct. 19, 2021, which is a continuation of application No. 29/769,945, filed on Feb. 8, 2021, now Pat. No. Des. 933,404, which is a continuation-in-part of application No. 29/754,701, filed on Oct. 13, 2020, which is a continuation of application No. 29/689,053, filed on Apr. 26, 2019, now Pat. No. Des. 898,489.

- (58) **Field of Classification Search**
 CPC A47F 5/0018; A47F 5/0043; A47F 5/10;
 A47F 7/00; A47F 5/0081
 See application file for complete search history.

(56) **References Cited**

U.S. PATENT DOCUMENTS

5,964,360 A * 10/1999 Hwang A47B 87/0215
 211/186
 7,204,569 B2 * 4/2007 Walburn A47B 96/16
 312/246
 D609,500 S * 2/2010 Fieldhouse D6/678
 D652,222 S * 1/2012 Edwards D6/349
 D691,404 S * 10/2013 Baum D6/705.7

D696,540 S * 12/2013 Dart D6/705.1
 D698,163 S * 1/2014 Edwards D6/349
 D710,980 S * 8/2014 Pollard, Jr. D23/308
 D716,065 S * 10/2014 Hubbard, Jr. D6/349
 9,010,552 B2 * 4/2015 Dart A47F 5/10
 211/186
 D746,087 S * 12/2015 Dart D6/678.1
 9,335,089 B1 * 5/2016 Gossens A47B 96/025
 D778,648 S * 2/2017 Johnson D6/705.7
 D785,386 S * 5/2017 Flaherty D6/707.15
 D832,623 S * 11/2018 Flaherty D6/655
 D834,862 S * 12/2018 Dart D6/705
 D898,489 S * 10/2020 Dart D6/678
 D899,159 S * 10/2020 Dart D6/678
 10,881,198 B1 * 1/2021 Chaoyi A47B 45/00
 D932,818 S * 10/2021 Dart D6/678
 D933,404 S * 10/2021 Dart D6/678.1
 D943,314 S * 2/2022 Guzman D6/654
 2001/0052505 A1 * 12/2001 Lee B65G 11/143
 211/74
 2004/0159622 A1 * 8/2004 Craft A47B 87/0246
 108/106
 2012/0223038 A1 * 9/2012 Bean A47B 96/021
 29/527.1
 2015/0068999 A1 * 3/2015 Dart A47B 57/20
 211/186
 2016/0106210 A1 * 4/2016 Kassanoff A47B 21/00
 108/60
 2016/0206090 A1 * 7/2016 Feeley A47B 21/0314
 2018/0132608 A1 * 5/2018 Benden A47B 97/00
 2018/0279773 A1 * 10/2018 Rink A47B 23/043
 2019/0328129 A1 * 10/2019 Namala A47B 9/20
 2020/0093259 A1 * 3/2020 Verhappen A47B 9/10
 2020/0146440 A1 * 5/2020 Fogarty A47B 21/02
 2021/0235862 A1 * 8/2021 Dart A47B 45/00

* cited by examiner

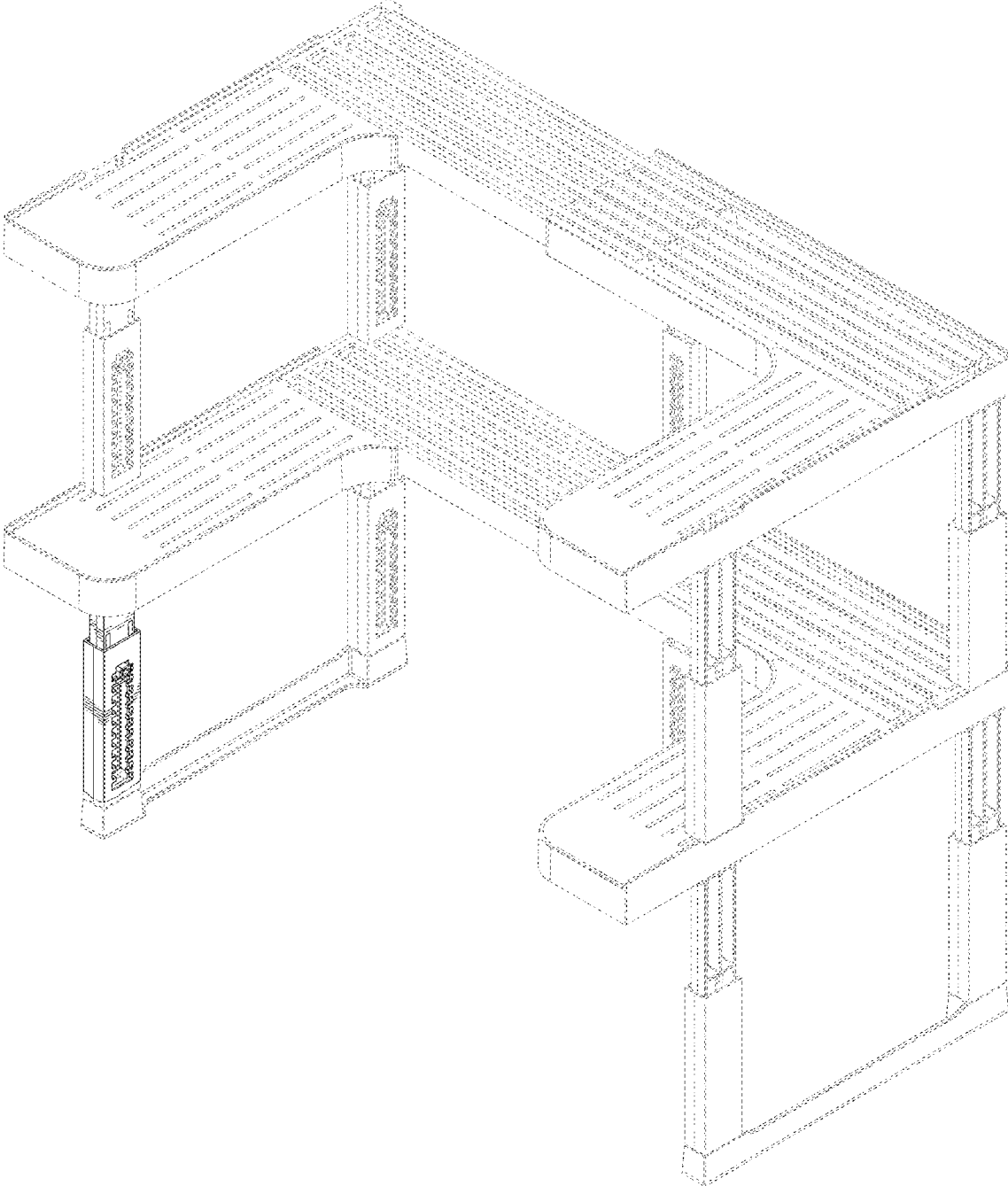

FIG. 1

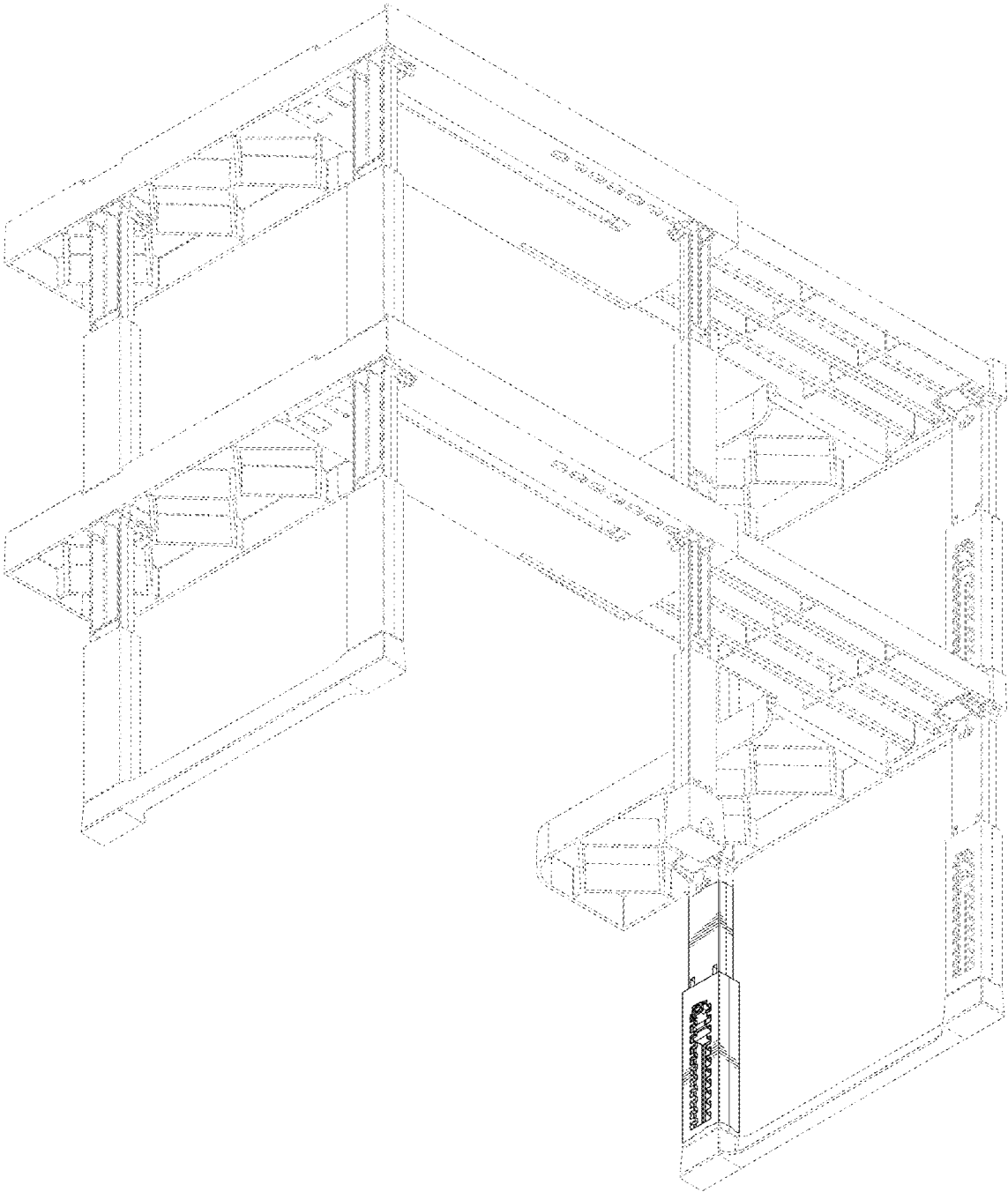

FIG. 2

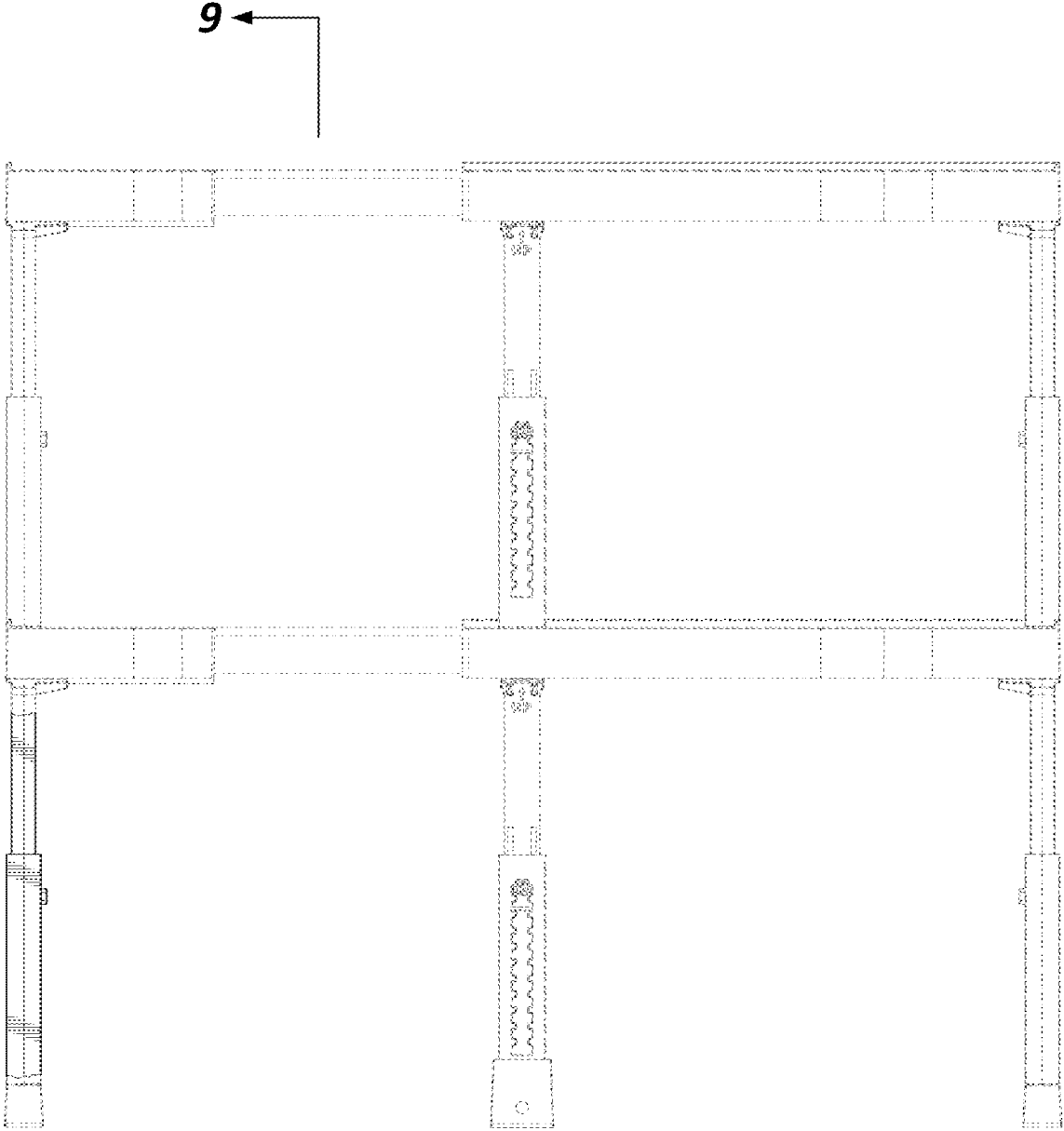

FIG. 3

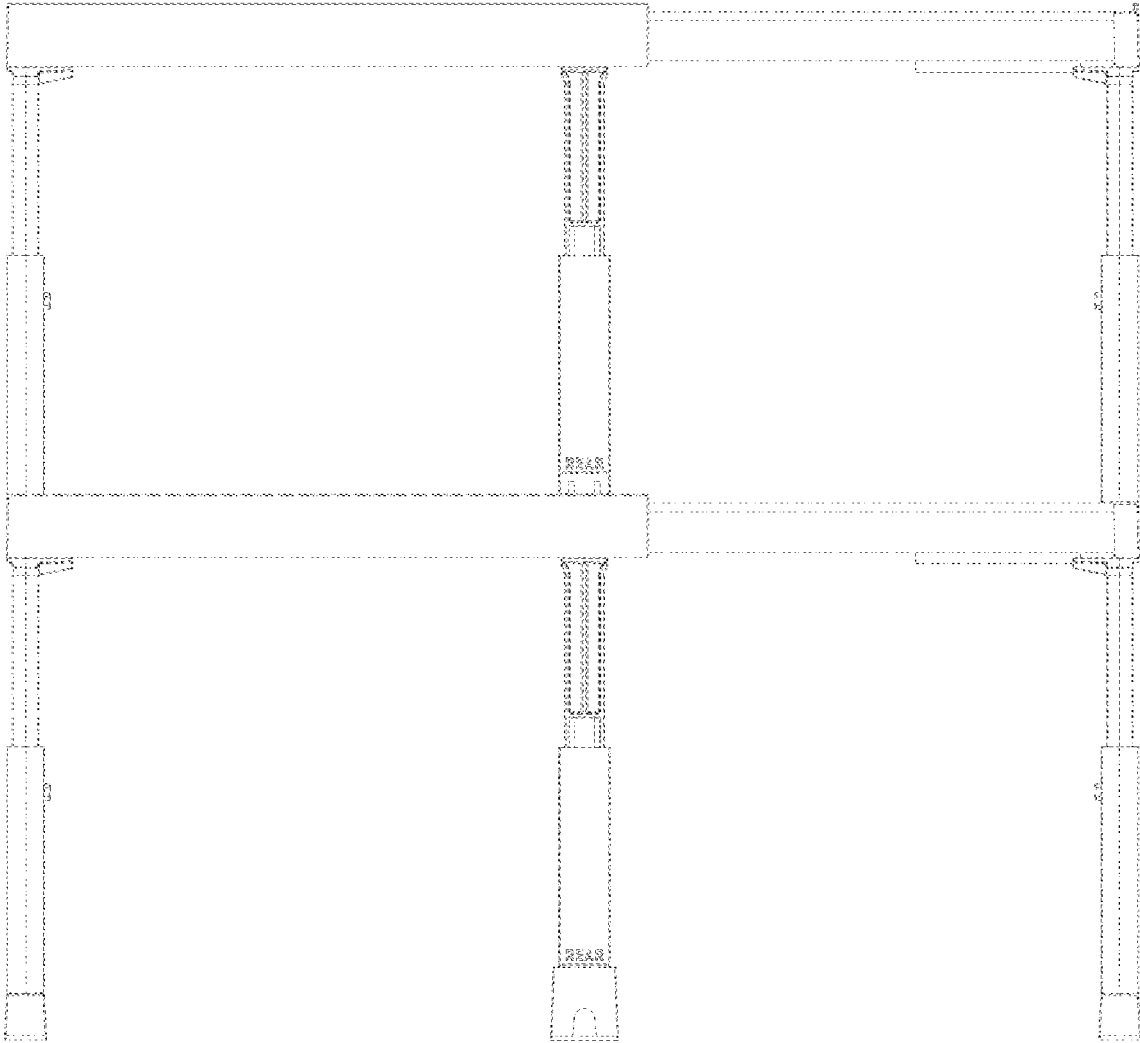

FIG. 4

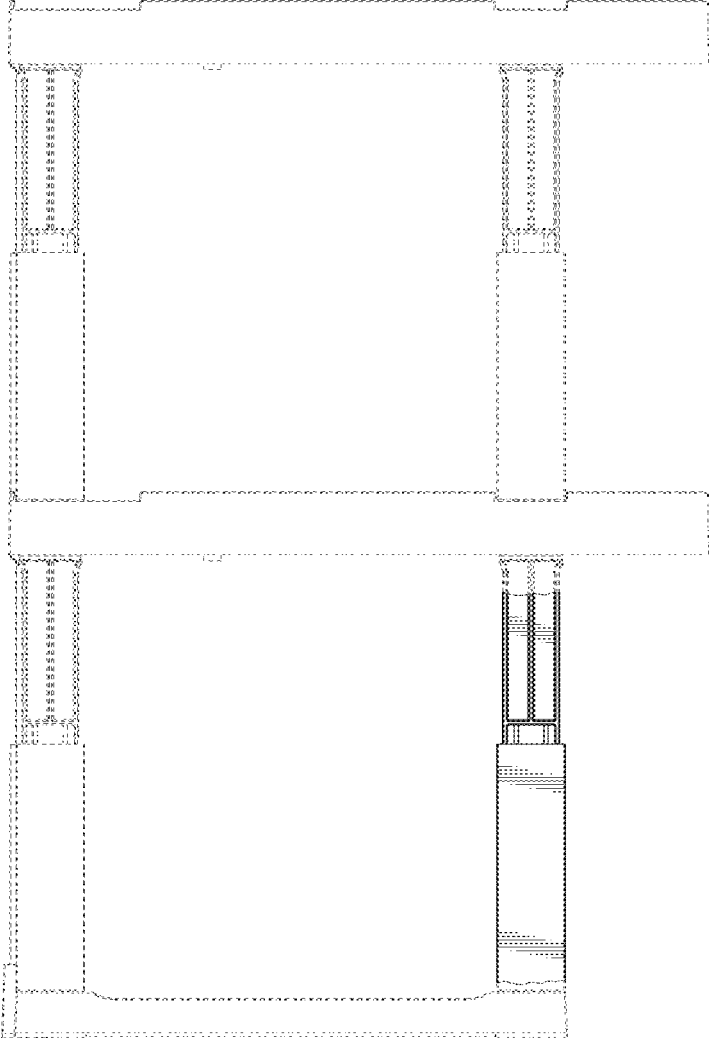

FIG. 5

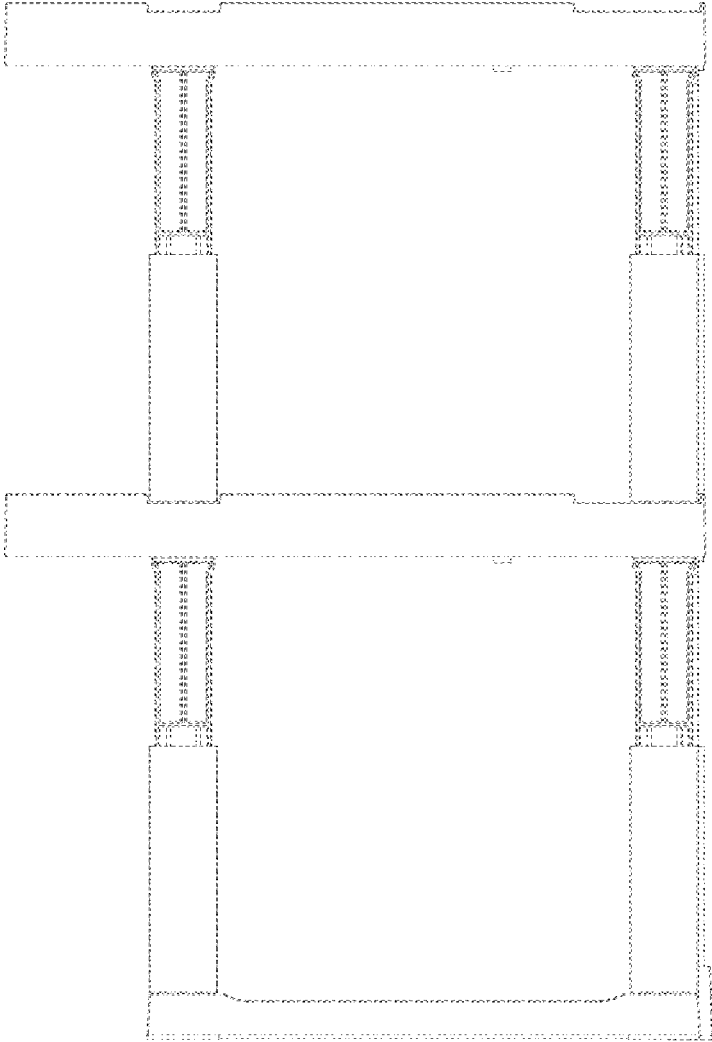

FIG. 6



FIG. 7

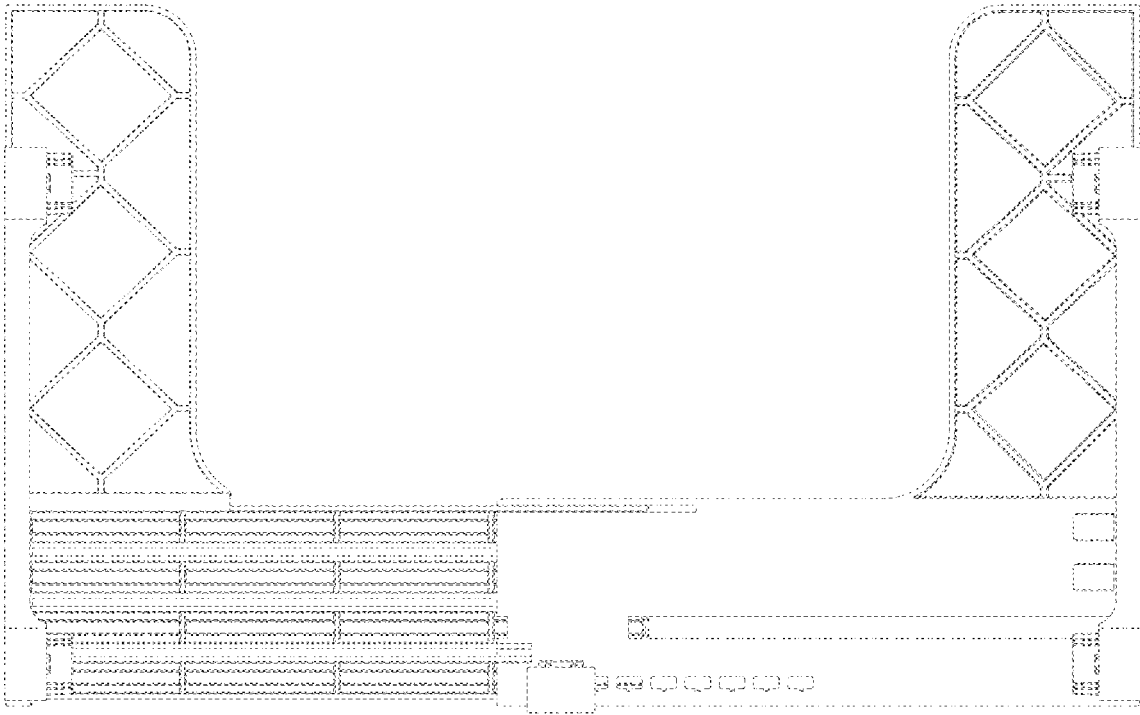

FIG. 8

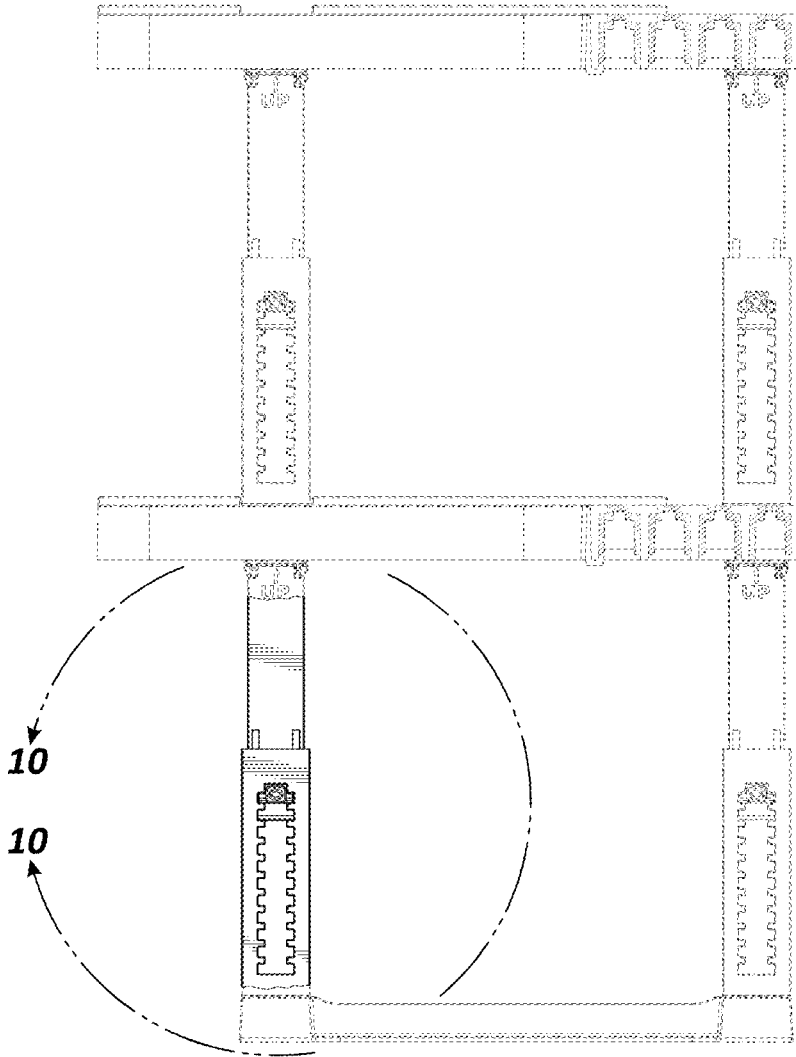

FIG. 9

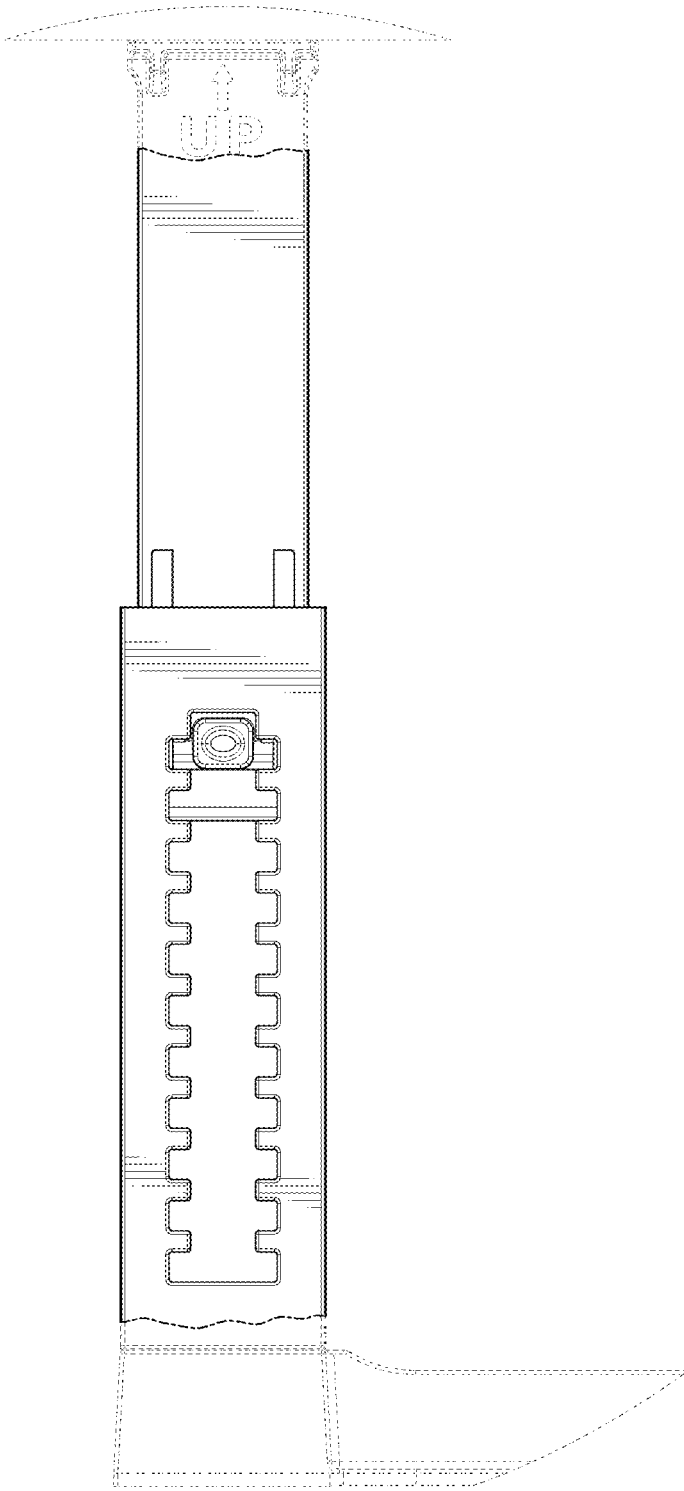

FIG. 10

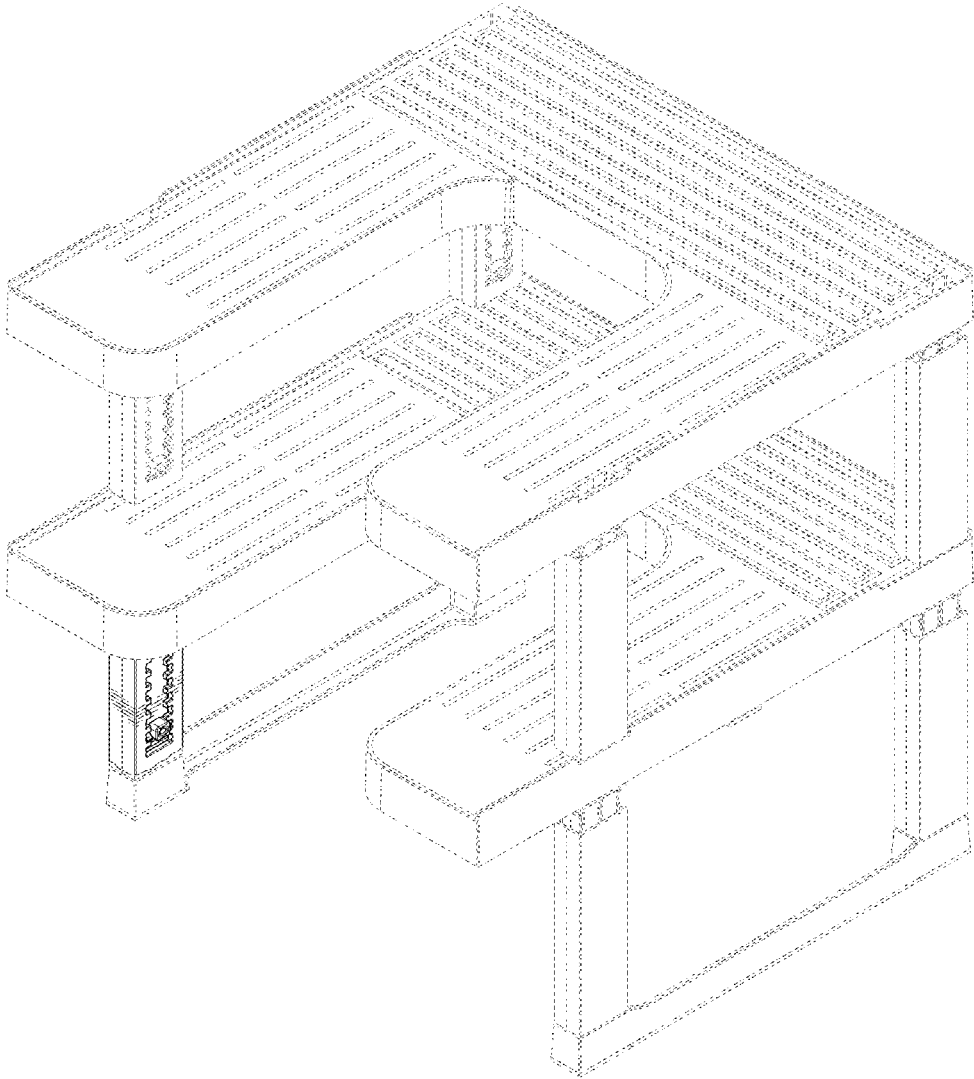

FIG. 11

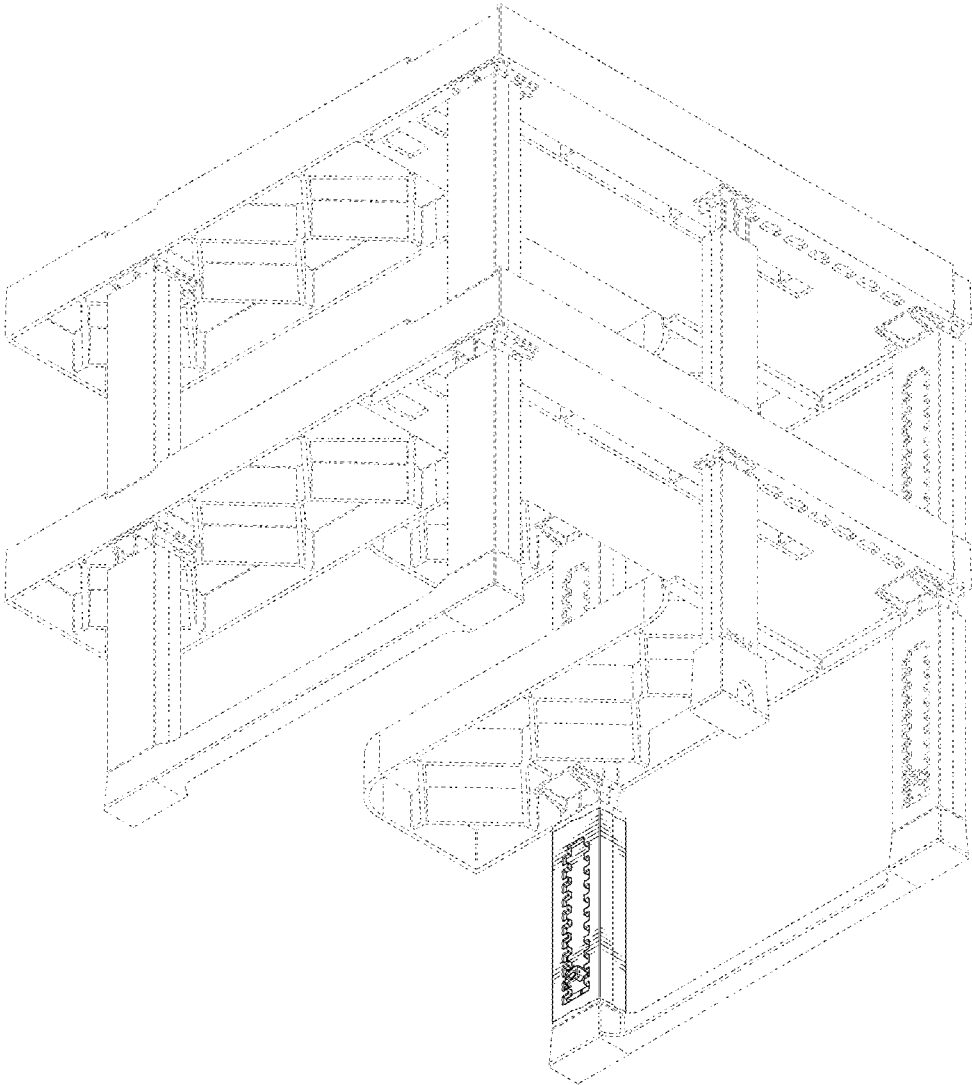
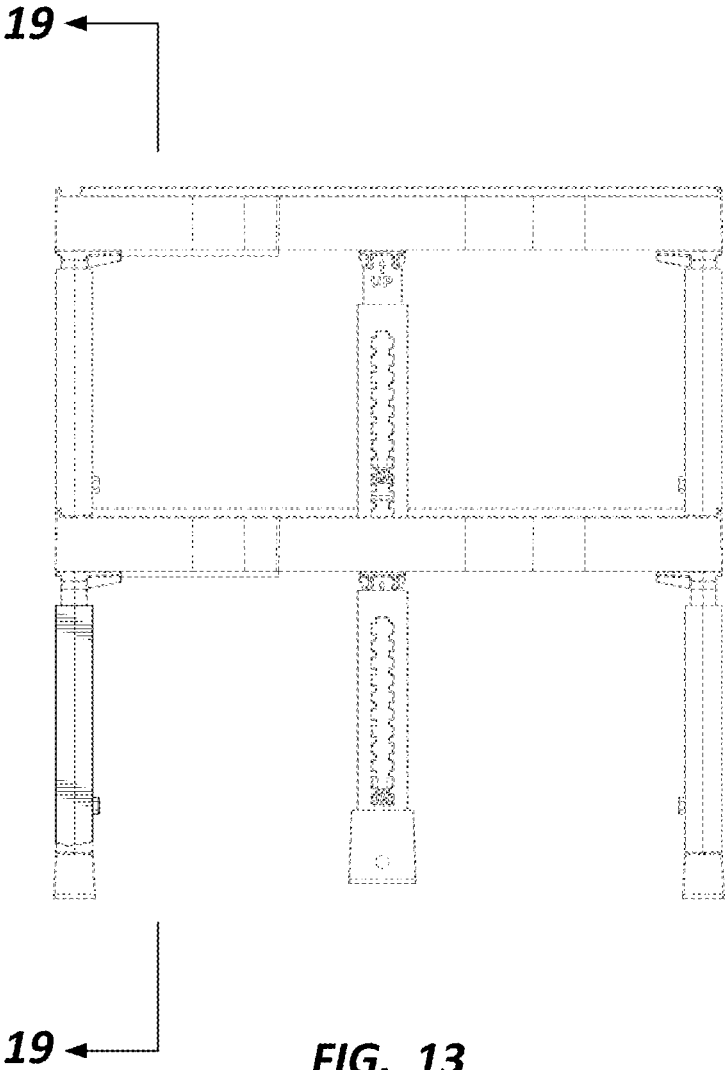

FIG. 12



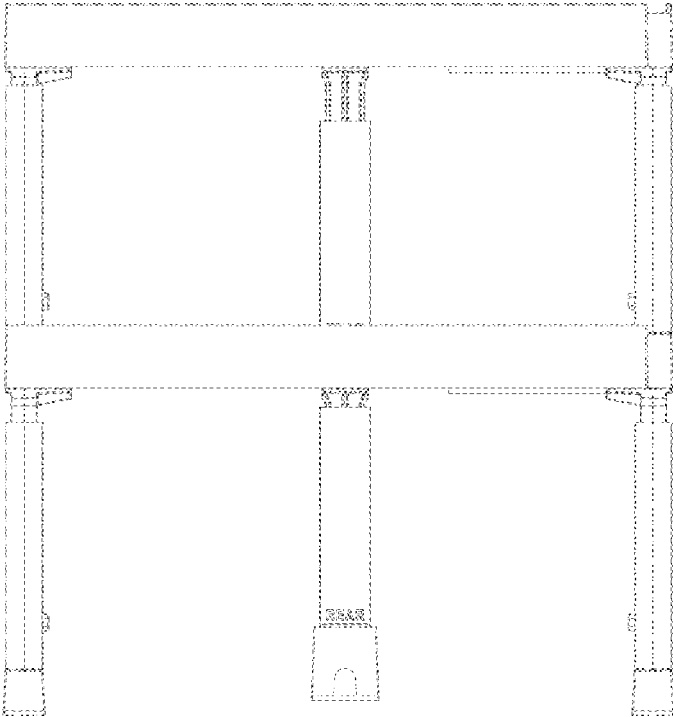

FIG. 14

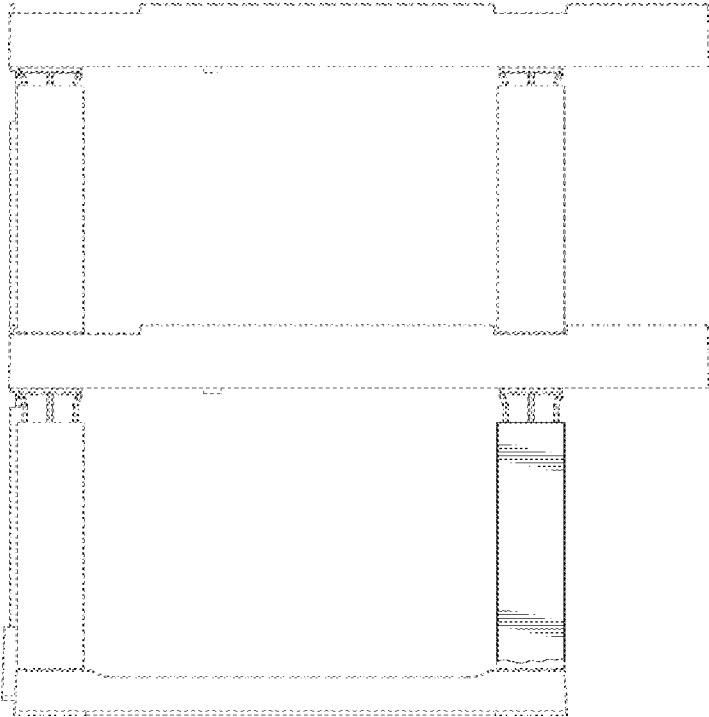

FIG. 15

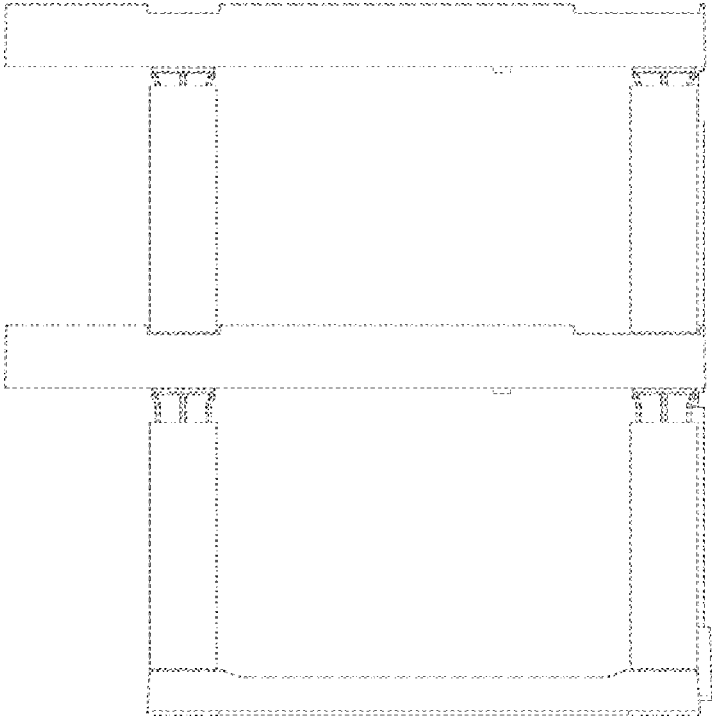

FIG. 16

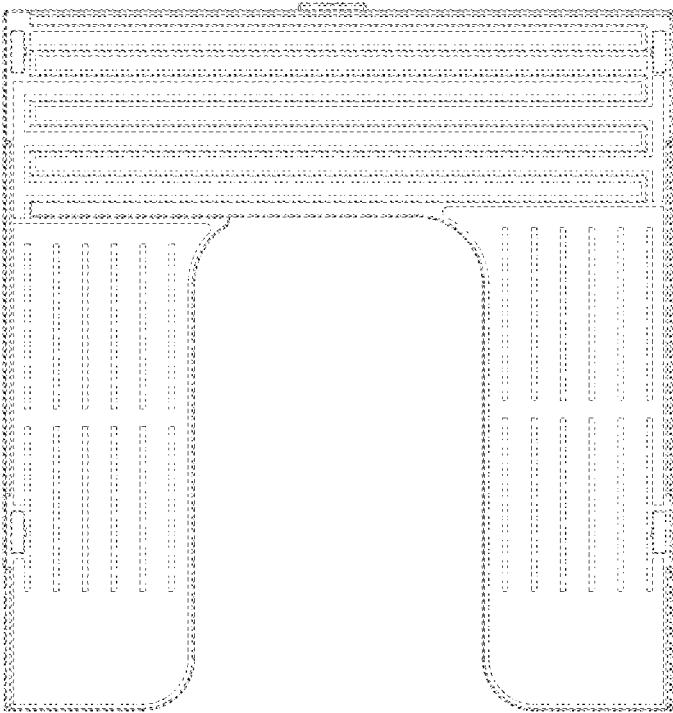

FIG. 17

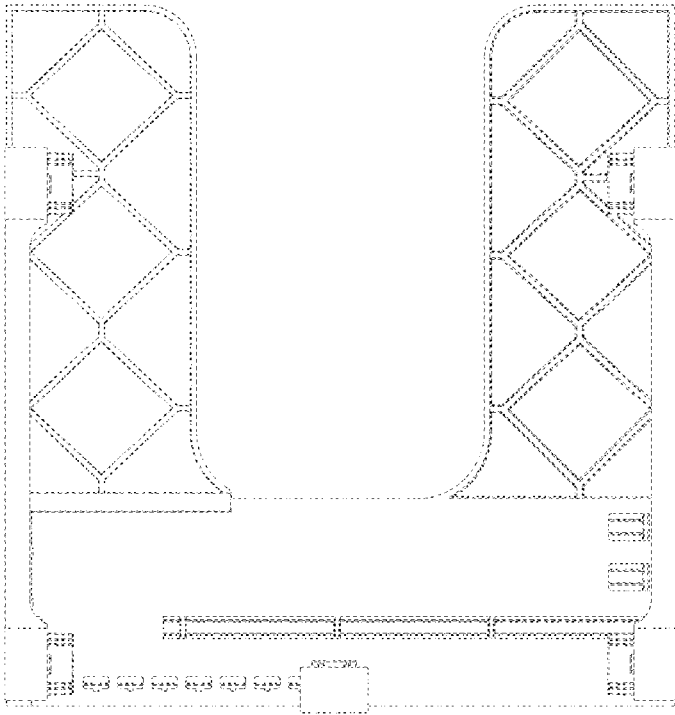

FIG. 18

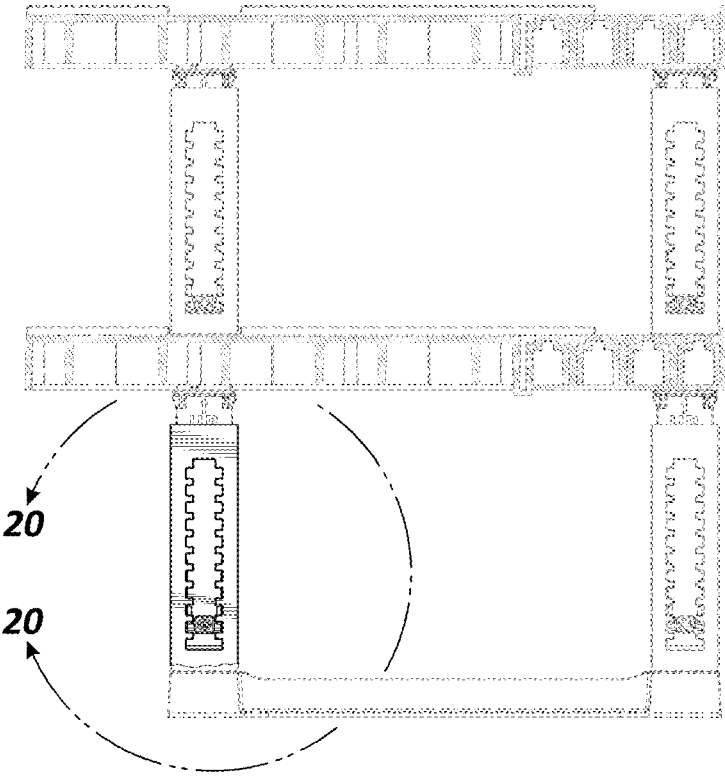

FIG. 19

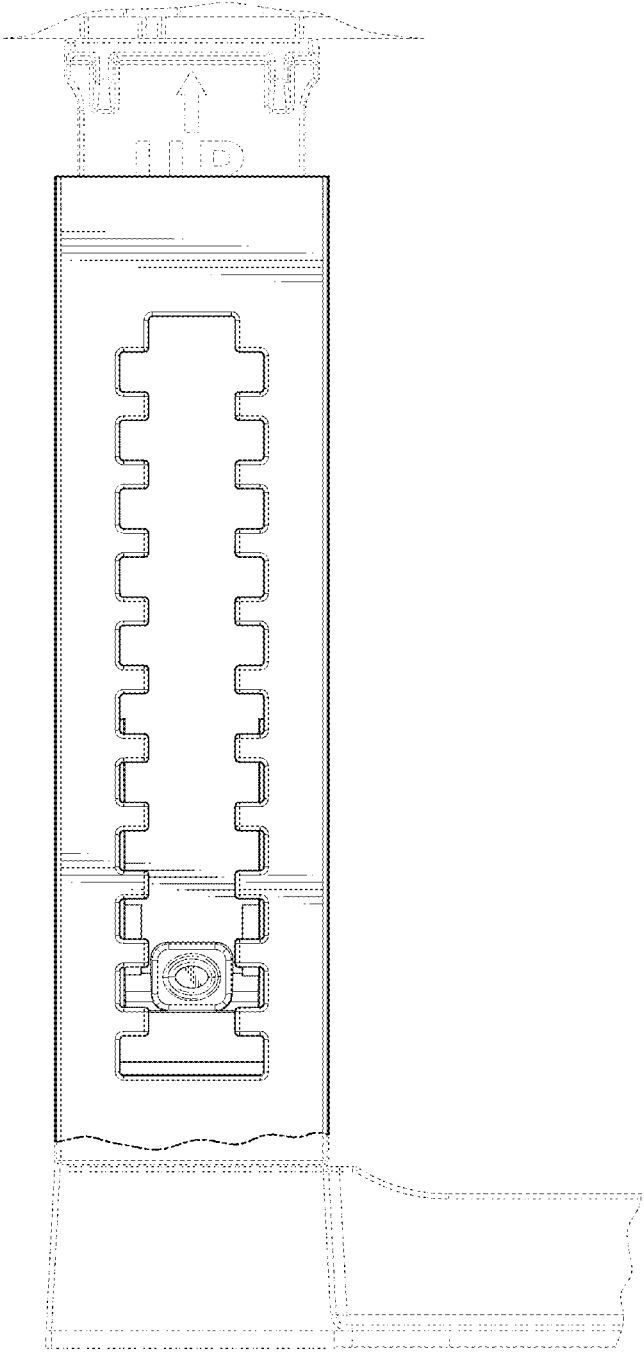

FIG. 20