



US00D506648S

(12) **United States Design Patent**  
**Mac William**

(10) **Patent No.:** **US D506,648 S**

(45) **Date of Patent:** **\*\* Jun. 28, 2005**

(54) **JUICER**

(75) Inventor: **Gilles Mac William**, Chicago, IL (US)

(73) Assignee: **SEB**, Selongey (FR)

(\*\*) Term: **14 Years**

(21) Appl. No.: **29/195,899**

(22) Filed: **Dec. 19, 2003**

(30) **Foreign Application Priority Data**

Jun. 19, 2003 (FR) ..... 03 3217

(51) **LOC (8) Cl.** ..... **31-00**

(52) **U.S. Cl.** ..... **D7/665**

(58) **Field of Search** ..... D7/665, 666, 678,  
D7/376, 378; 99/501-513, 348, 357, 492,  
499; 241/100

(56) **References Cited**

**U.S. PATENT DOCUMENTS**

5,088,392 A \* 2/1992 Ancona et al. .... 99/499  
D379,744 S \* 6/1997 Thackray ..... D7/665

\* cited by examiner

*Primary Examiner*—Terry A. Wallace

(74) *Attorney, Agent, or Firm*—Browdy and Neimark,  
P.L.L.C.

(57) **CLAIM**

The ornamental design for juicer, as shown.

**DESCRIPTION**

FIG. 1 is a front elevational view of a first embodiment of a juicer in accordance with the present design; FIG. 2 is a rear elevational view thereof; FIG. 3 is a left side elevational view thereof; FIG. 4 is a right side elevational view thereof; FIG. 5 is a top plan view thereof; FIG. 6 is a bottom plan view thereof; FIG. 7 is a perspective view thereof; FIG. 8 is a front elevational view of a second embodiment of a juicer in accordance with the present design; FIG. 9 is a rear elevational view thereof; FIG. 10 is a left side elevational view thereof; FIG. 11 is a right side elevational view thereof; FIG. 12 is a top plan view thereof; FIG. 13 is a bottom plan view thereof; and, FIG. 14 is a perspective view thereof.

**1 Claim, 14 Drawing Sheets**

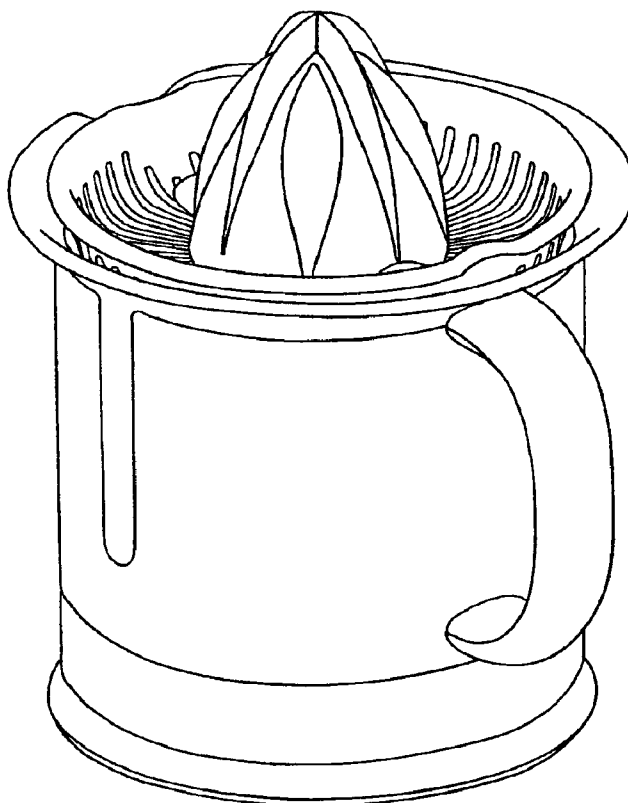

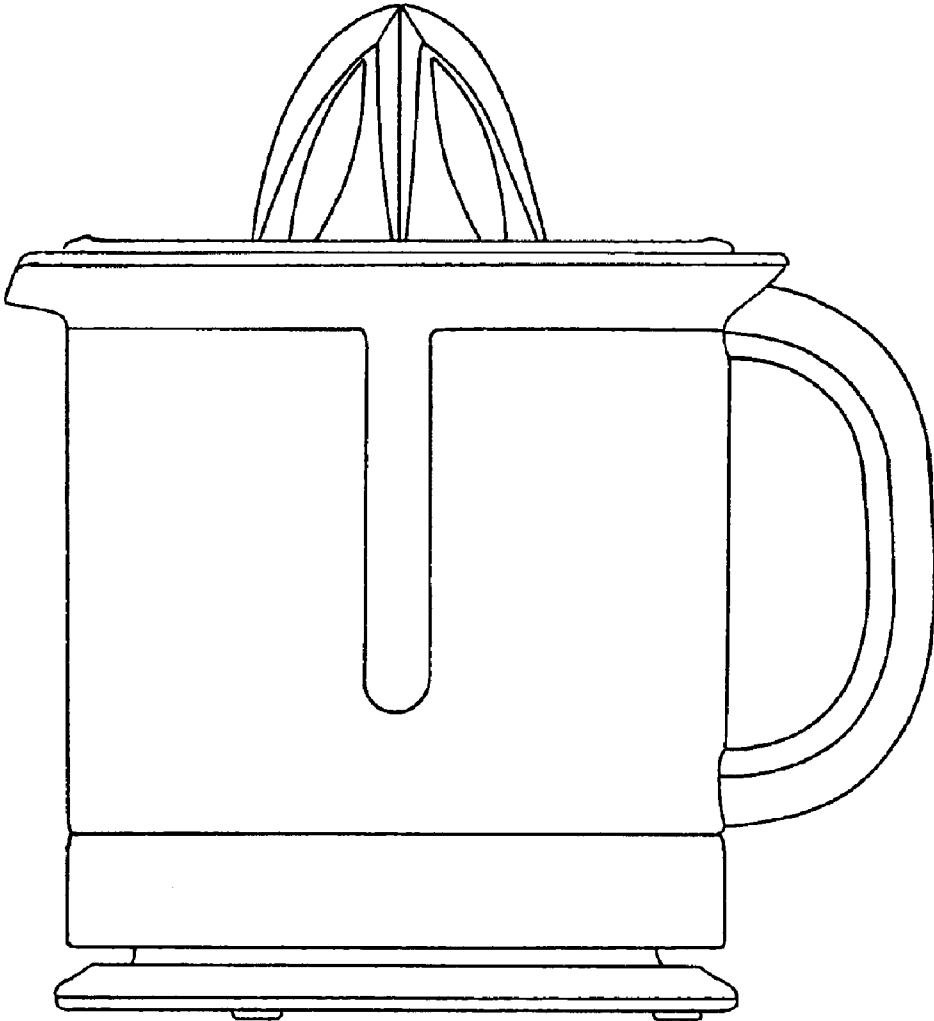

FIG. 1

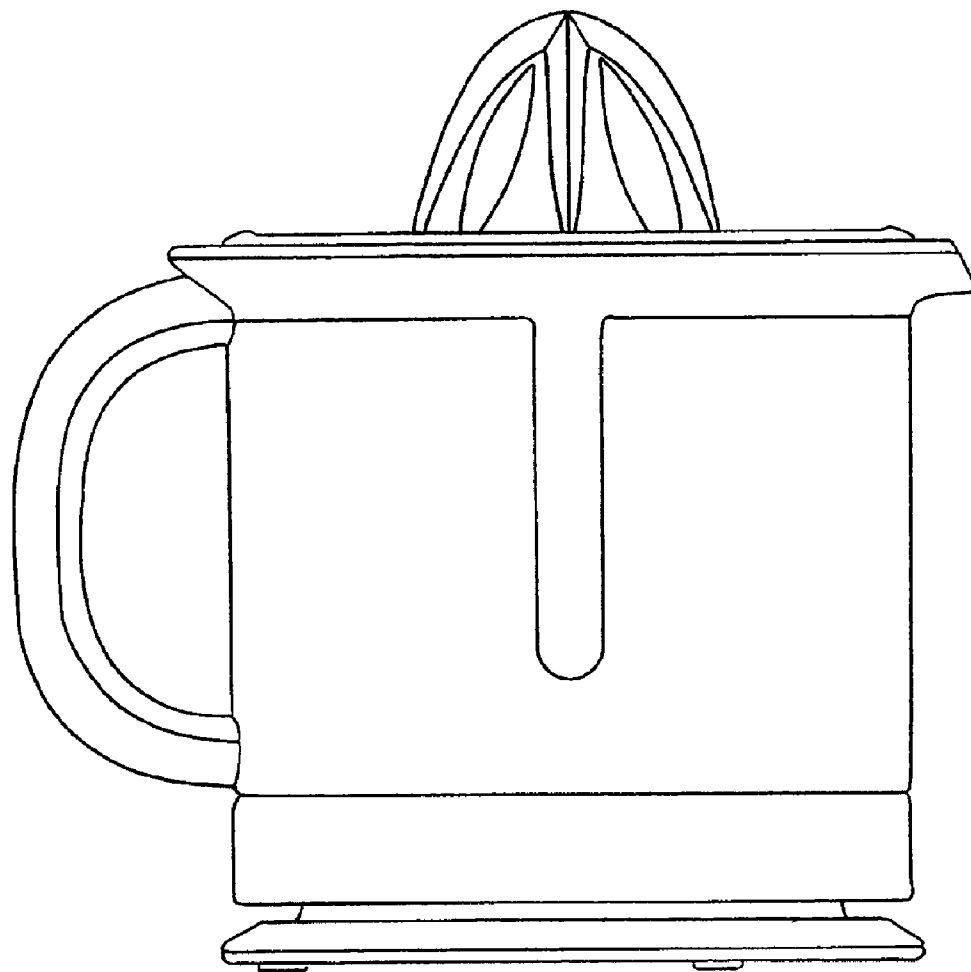

FIG 2

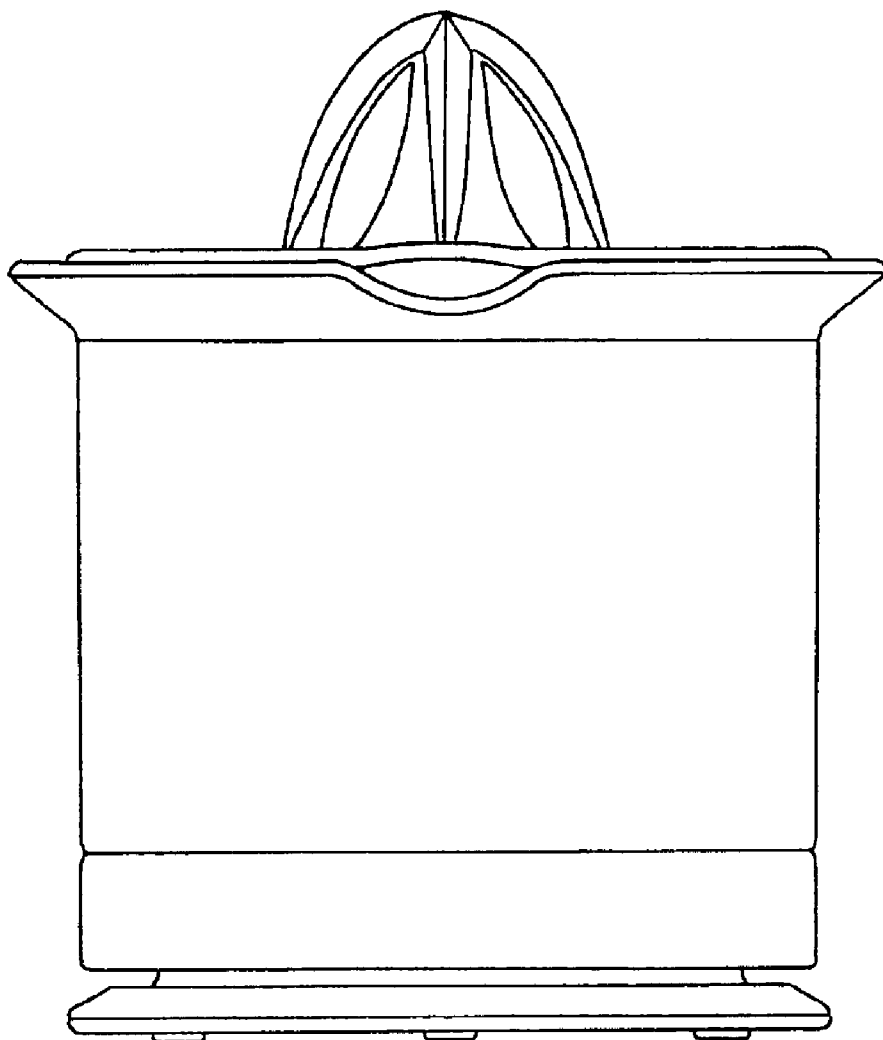

FIG 3

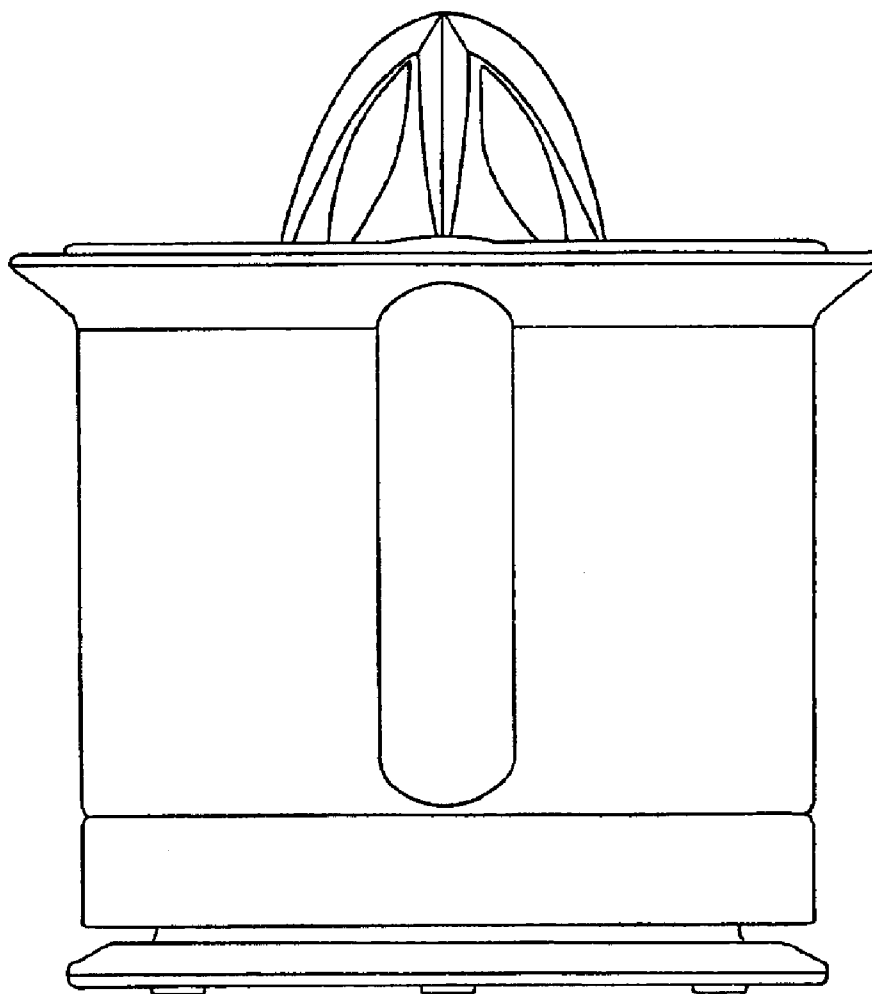

FIG. 4

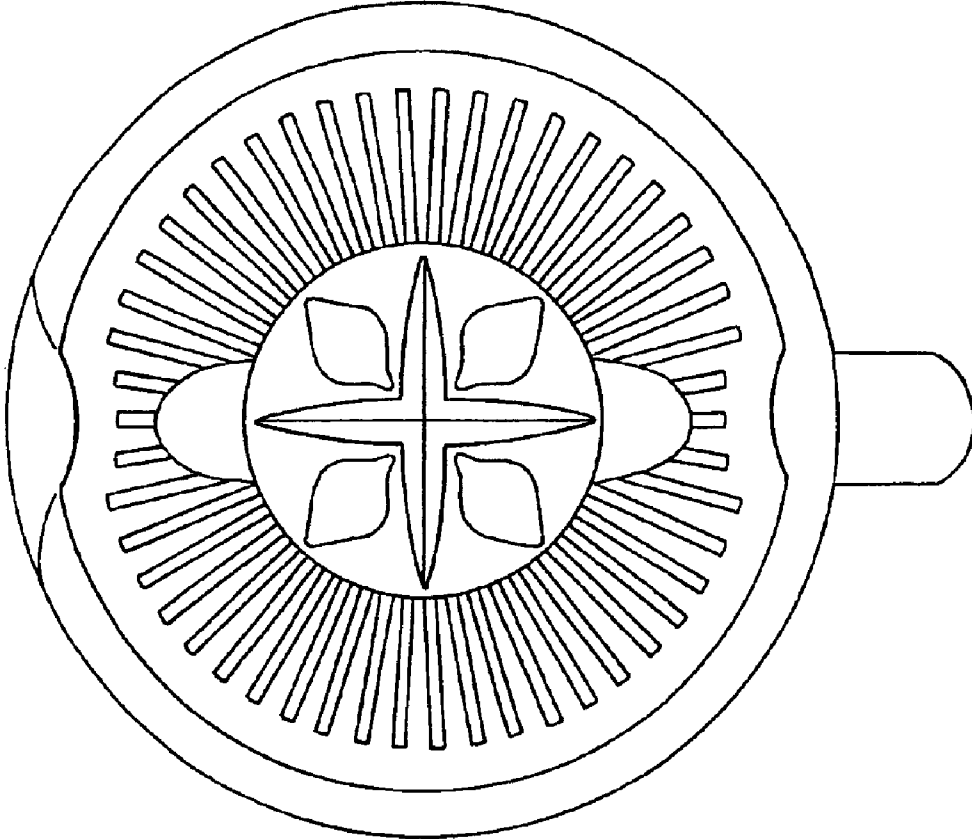

FIG. 5

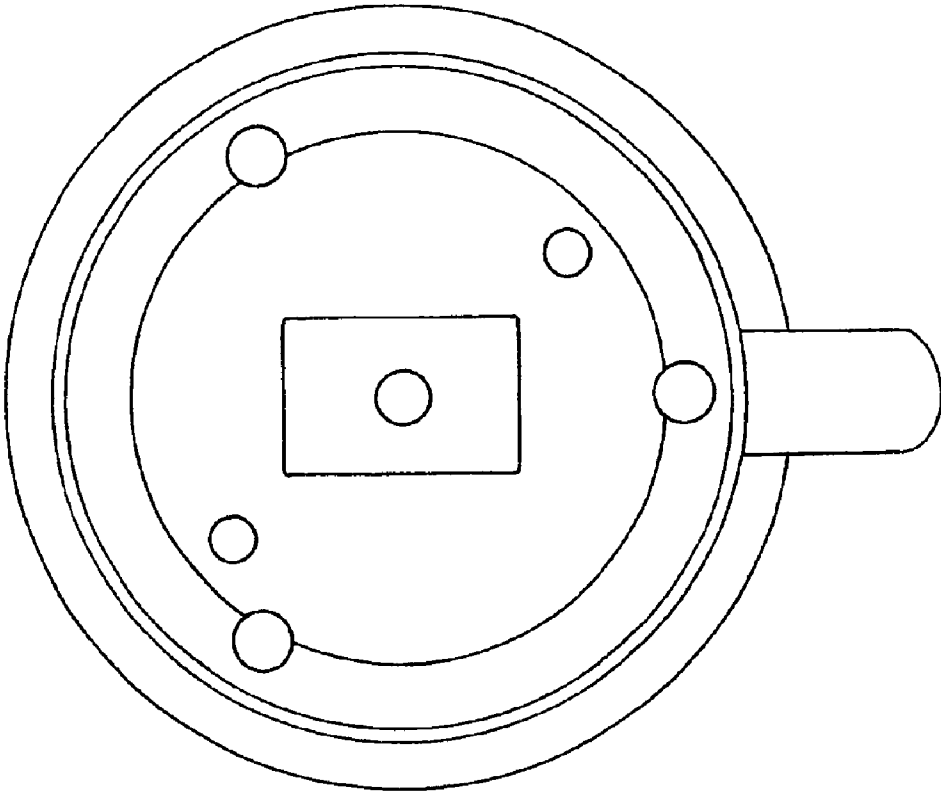

FIG. 6

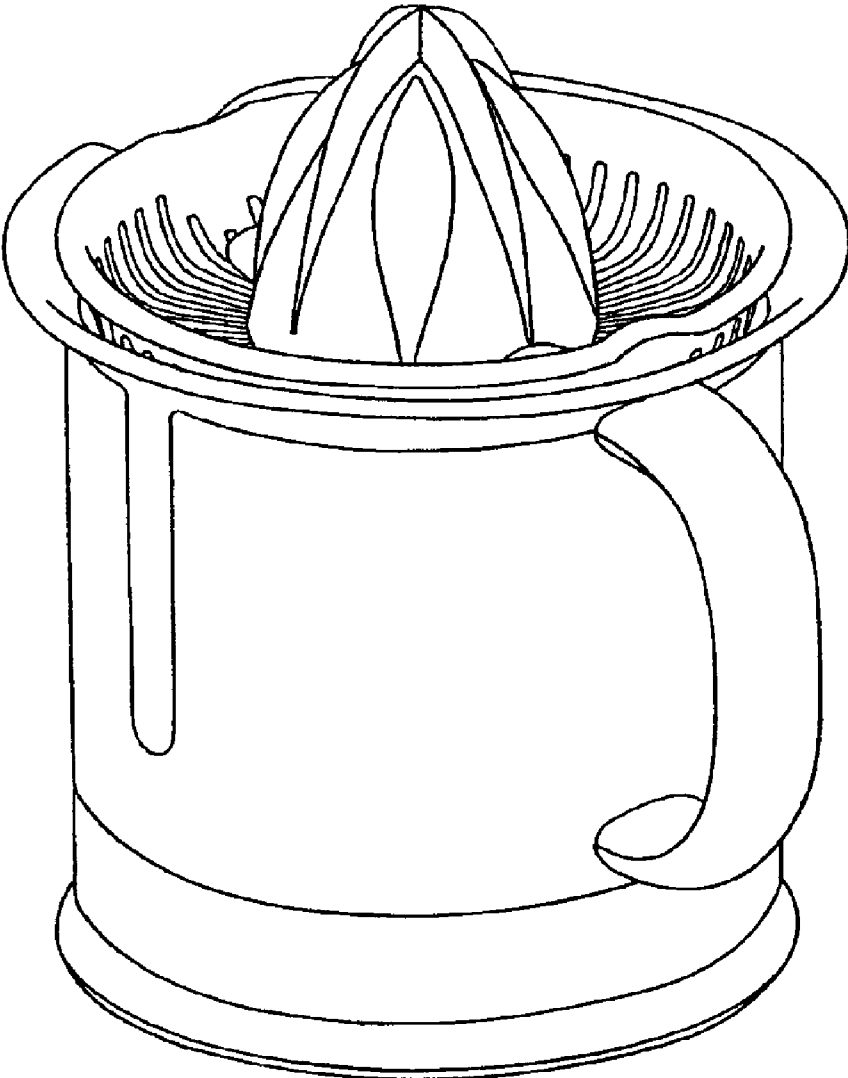

FIG. 7



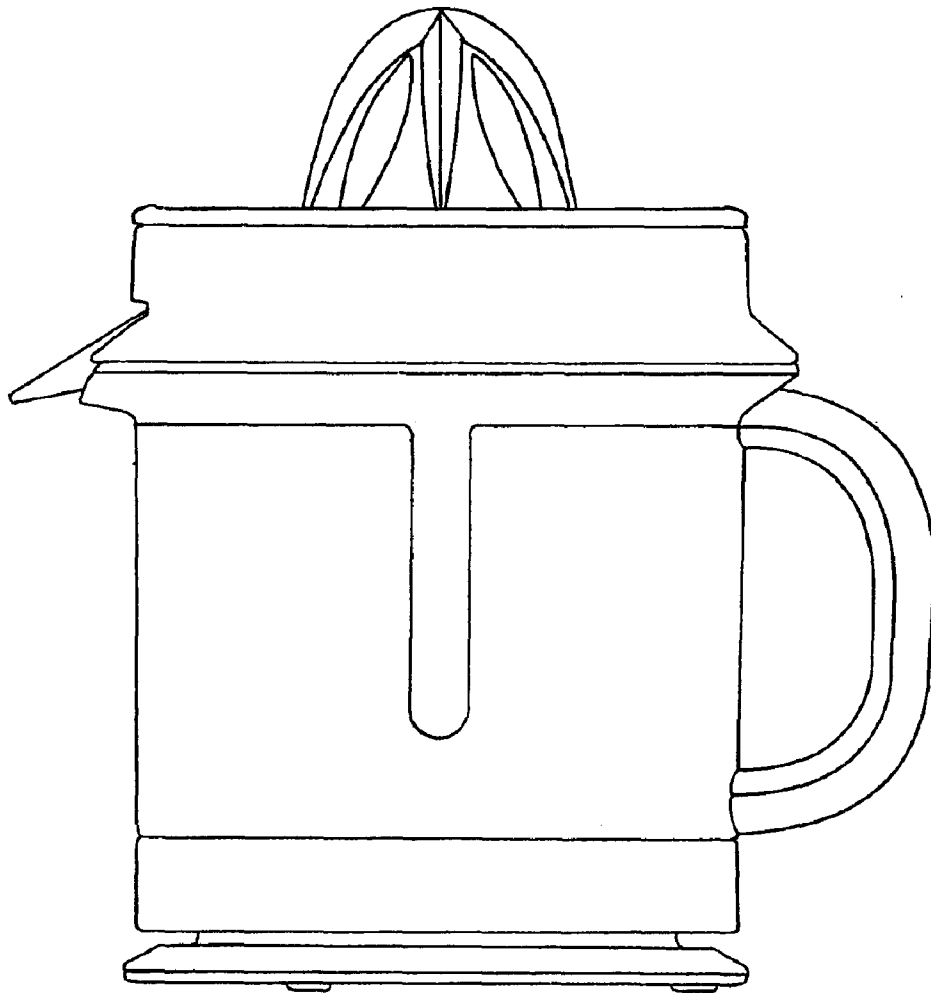

FIG. 8

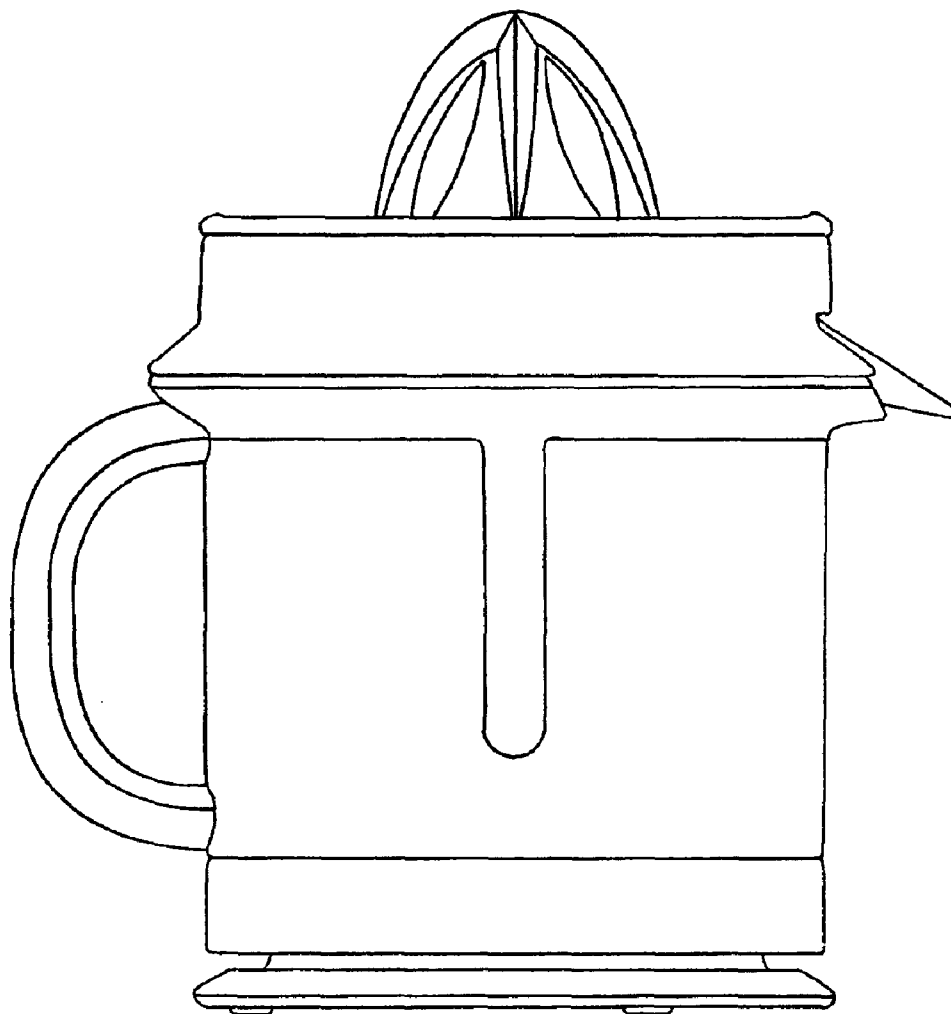

FIG 9

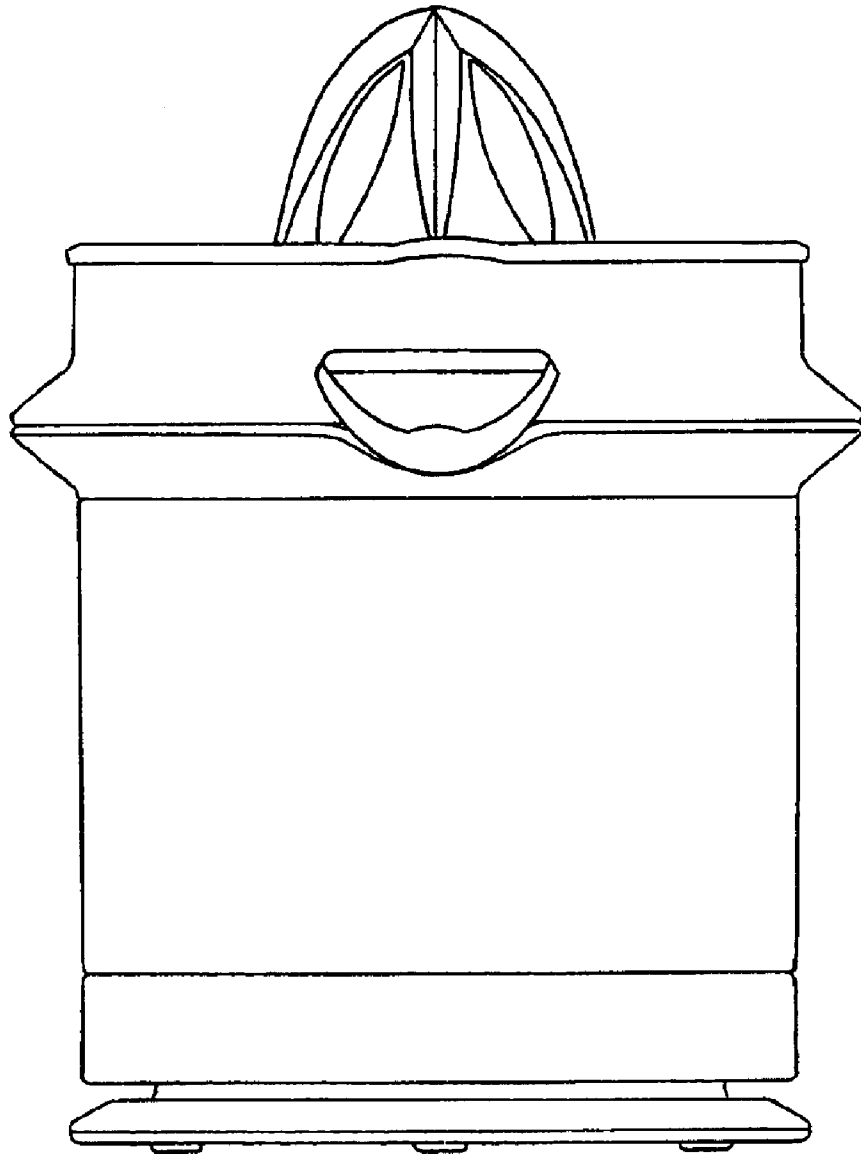

FIG 10

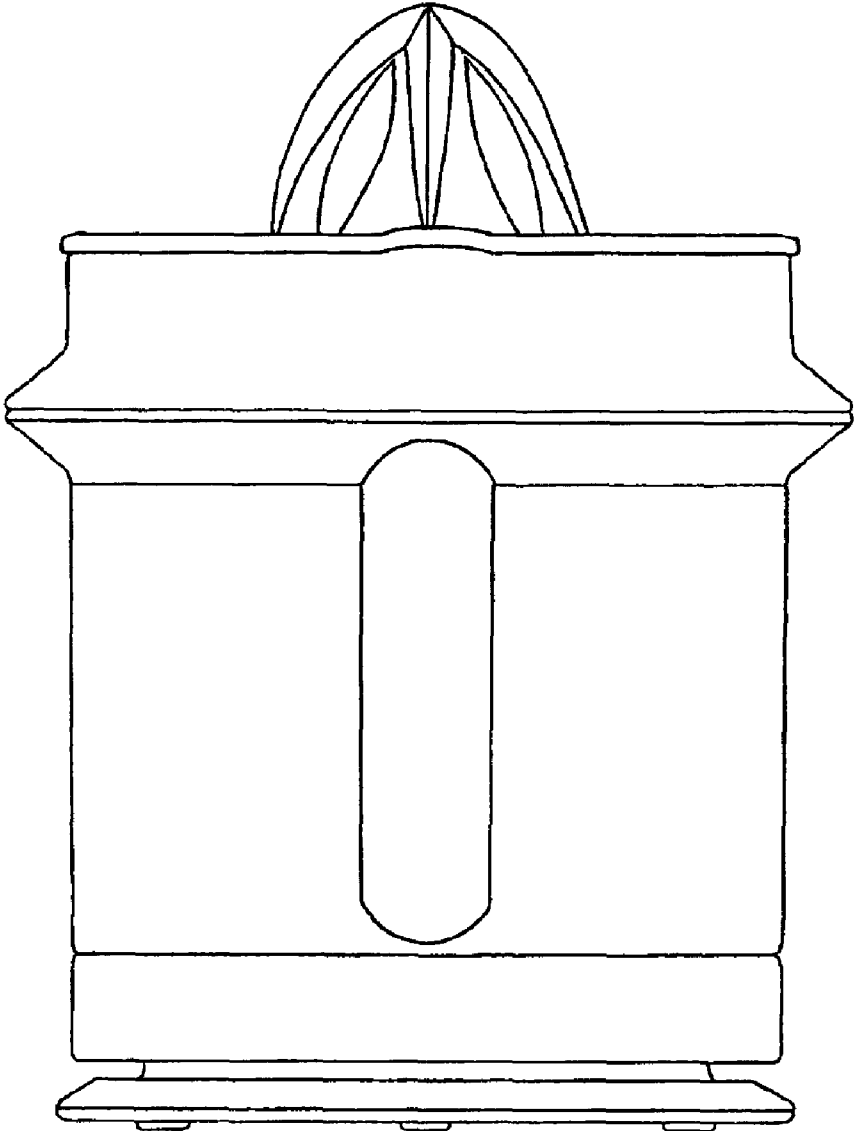

FIG II

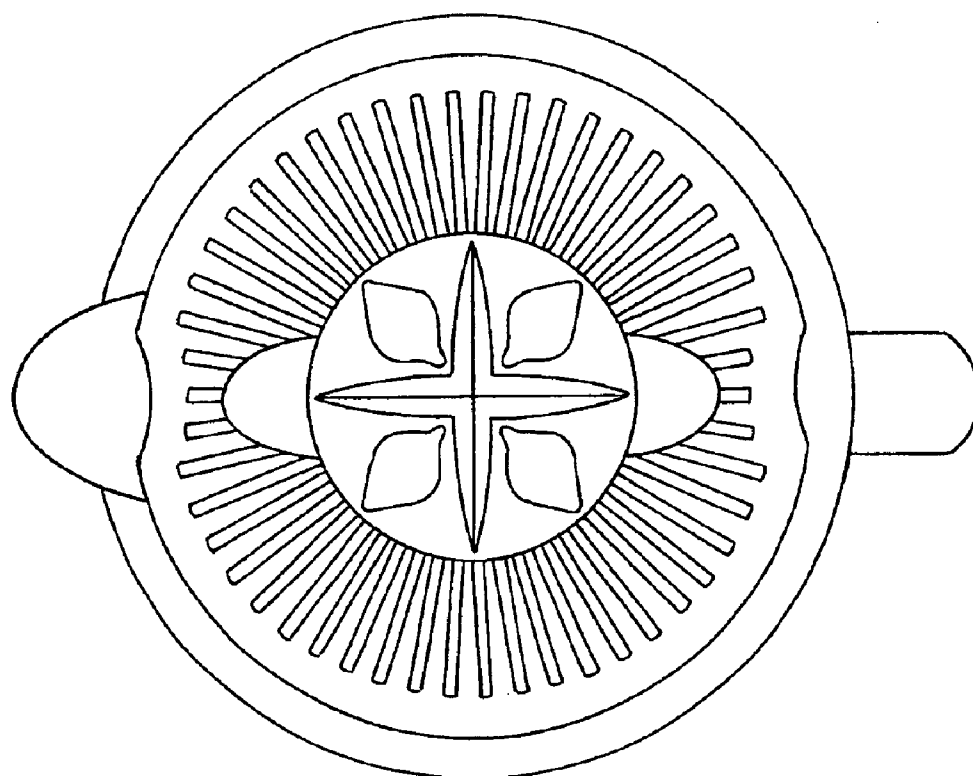

FIG 12

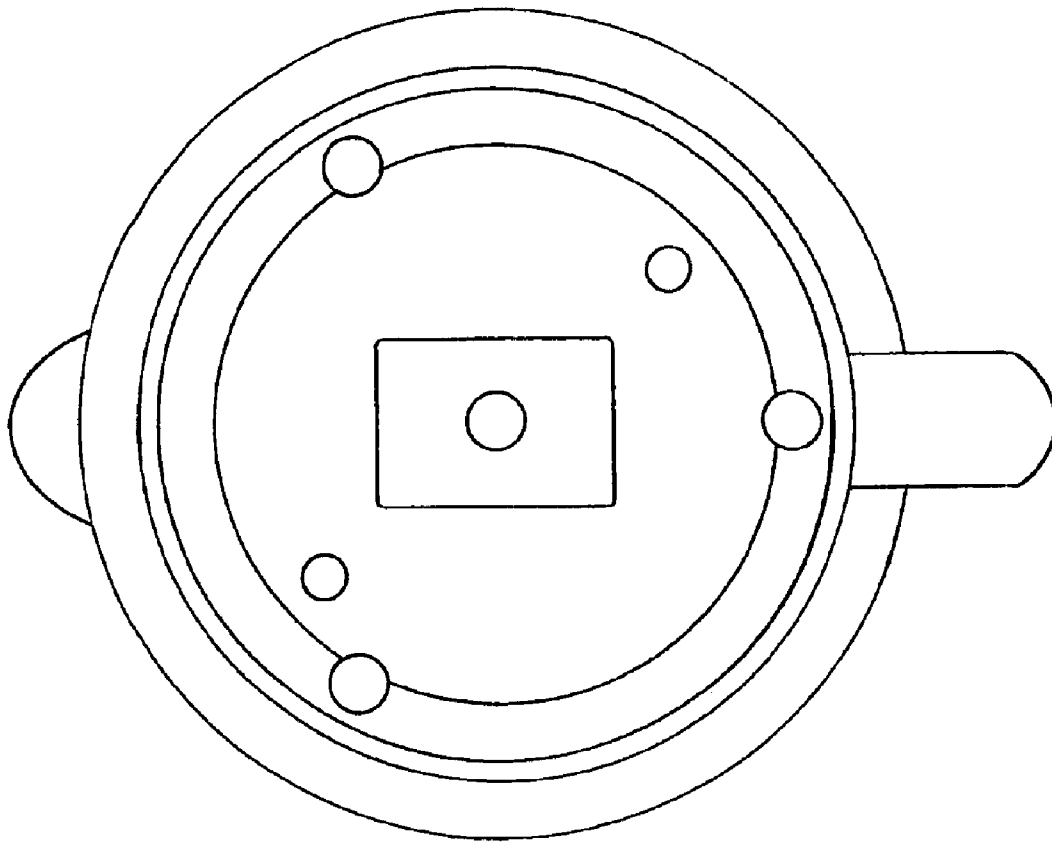

FIG 13

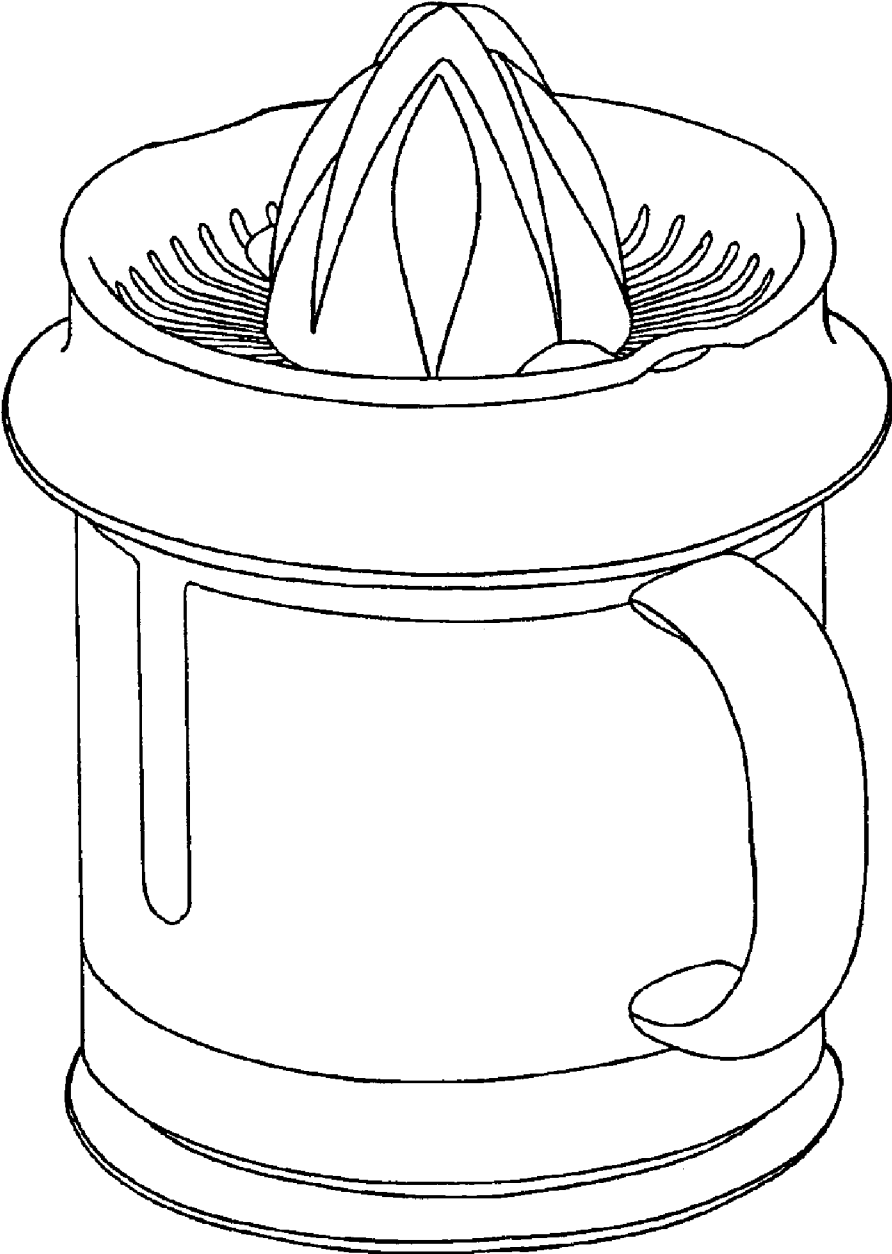

FIG. 14