

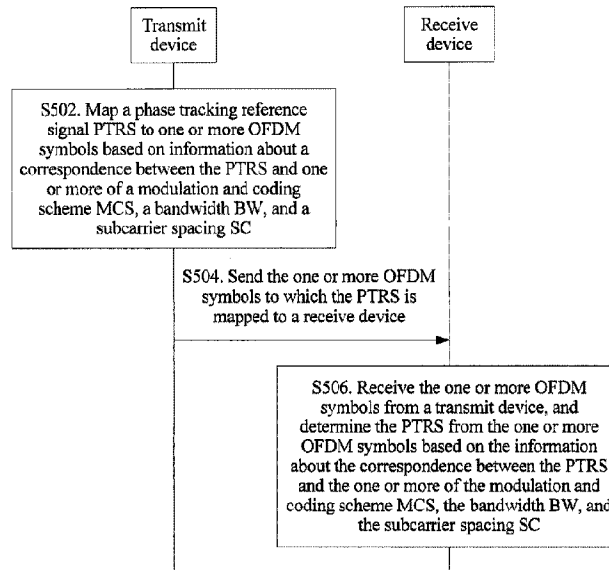

(86) Date de dépôt PCT/PCT Filing Date: 2017/10/20
 (87) Date publication PCT/PCT Publication Date: 2018/07/12
 (45) Date de délivrance/Issue Date: 2024/02/27
 (85) Entrée phase nationale/National Entry: 2019/07/05
 (86) N° demande PCT/PCT Application No.: CN 2017/107135
 (87) N° publication PCT/PCT Publication No.: 2018/126763
 (30) Priorité/Priority: 2017/01/06 (CN201710011404.4)

(51) Cl.Int./Int.Cl. *H04L 5/00* (2006.01)
 (72) Inventeurs/Inventors:
 ZHANG, XI, CN;
 WEN, RONG, CN;
 CHEN, LEI, CN
 (73) Propriétaire/Owner:
 HUAWEI TECHNOLOGIES CO., LTD., CN
 (74) Agent: GOWLING WLG (CANADA) LLP

(54) Titre : PROCÉDE, APPAREIL ET SYSTÈME DE CONFIGURATION DE FORMAT DE SIGNAL DE RÉFÉRENCE
 (54) Title: REFERENCE SIGNAL CONFIGURATION METHOD, APPARATUS, AND SYSTEM



(57) **Abrégé/Abstract:**

Embodiments of the present invention provide a reference signal configuration method, an apparatus, and a system. The method includes: mapping a phase tracking reference signal (PTRS) to one or more OFDM symbols based on information about a correspondence between the PTRS and one or more of a modulation and coding scheme (MCS), a subcarrier spacing, and a bandwidth (BW); and sending the one or more OFDM symbols to which the PTRS is mapped to a receive device. In the embodiments of the present invention, a correspondence between the PTRS and the subcarrier spacing or the modulation and coding scheme or the bandwidth is used to implicitly indicate a time-frequency location of the PTRS. In comparison with the prior art, no explicit indication is required, and signaling overheads are reduced.

ABSTRACT

Embodiments of the present invention provide a reference signal configuration method, an apparatus, and a system. The method includes: mapping a phase tracking reference signal (PTRS) to one or more OFDM symbols based on information about a
5 correspondence between the PTRS and one or more of a modulation and coding scheme (MCS), a subcarrier spacing, and a bandwidth (BW); and sending the one or more OFDM symbols to which the PTRS is mapped to a receive device. In the
embodiments of the present invention, a correspondence between the PTRS and the subcarrier spacing or the modulation and coding scheme or the bandwidth is used to
10 implicitly indicate a time-frequency location of the PTRS. In comparison with the prior art, no explicit indication is required, and signaling overheads are reduced.

REFERENCE SIGNAL CONFIGURATION METHOD, APPARATUS, AND SYSTEM

TECHNICAL FIELD

[0001] The present invention relates to the field of communications technologies,
5 and in particular, to a reference signal configuration method, an apparatus, and a system.

BACKGROUND

[0002] A 5G communications system uses a higher carrier frequency (referred to
as high frequency) than a Long Term Evolution (Long Term Evolution, LTE) system.
10 According to a current standard, it is specified that generally a 6 GHz frequency or
above is a high frequency. Frequency bands such as 28 GHz, 38 GHz, and 72 GHz are
currently researched as a focus, to implement wireless communication with a larger
bandwidth and a higher transmission rate. However, a high-frequency system has a
more serious intermediate radio frequency distortion, especially stronger phase noise
15 impact relative to conventional low-frequency communication. In addition, impact of
a Doppler shift and a carrier frequency offset (Carrier Frequency Offset, CFO) may
increase as a frequency increases.

[0003] Multiple-input multiple-output-orthogonal frequency division multiplexing
(Massive input massive output-Orthogonal Frequency Division Multiplexing,
20 MIMO-OFDM) is used as an example. In consideration of phase noise and carrier
frequency offsets at both a receive end and a transmit end, a receiving expression for
an nth receive antenna on a kth subcarrier after fast Fourier transform (Fast Fourier
Transform, FFT) at the receive end is:

$$Y_n^k = \sum_{m=1}^M H_{nm}^k \underbrace{P_n^{r,0} P_m^{t,0}}_{CPE} S_m^k + \underbrace{\sum_{m=1}^M \sum_{i=0}^{K-1} P_n^{r,(k-i)K} H_{nm}^i \sum_{l=0, l \neq i \& l \neq k}^{K-1} P_m^{t,(i-l)} S_m^l}_{ICI} + Z_n^k, \text{ where}$$

$$25 \quad P_n^{r,k} = \frac{1}{K} \sum_{t=0}^{K-1} e^{j\theta_n^r(t)} e^{j2\pi tk/K}, P_m^{t,k} = \frac{1}{K} \sum_{t=0}^{K-1} e^{j\theta_m^t(t)} e^{j2\pi tk/K}; \text{ and}$$

in this case,

$$P_n^{r,0} = \frac{1}{K} \sum_{t=0}^{K-1} e^{j\theta_n^r(t)}, P_m^{t,0} = \frac{1}{K} \sum_{t=0}^{K-1} e^{j\theta_m^t(t)}$$

[0004] H_{mm}^k indicates a channel from an m^{th} transmit antenna to the n^{th} receive antenna on the k^{th} subcarrier, S_m^k indicates sent data of the m^{th} antenna on the k^{th} subcarrier, Z_n^k indicates noise on the n^{th} receive antenna on the k^{th} subcarrier, $P_n^{r,k}$ indicates a phase offset on the n^{th} receive antenna on the k^{th} subcarrier that is caused by the phase noise and the CFO at the receive end, and $P_m^{t,k}$ indicates a phase offset on an m^{th} transmit antenna on the k^{th} subcarrier that is caused by the phase noise and the CFO at the transmit end. It can be learned from the expression that impact of phase noise on OFDM performance mainly lies in two aspects: a common phase error (Common Phase Error, CPE) and inter-carrier interference (Inter-carrier Interference, ICI), and impact of the CFO on the OFDM performance mainly lies in the ICI. In an actual system, the ICI has weaker impact on performance than the CPE. Therefore, usually the CPE is preferably compensated for in a phase noise compensation solution.

[0005] Phase noise is used as an example. As a frequency band increases, a phase noise level decreases by $20 \cdot \log(f_1/f_2)$. A 2 GHz frequency band and a 28 GHz frequency band are used as examples. A phase noise level of the 28 GHz frequency band is 23 dB higher than that of the 2 GHz frequency band. A higher phase noise level indicates stronger common phase error (Common Phase Error, CPE) impact and a larger phase error caused by a CPE, as shown in FIG. 1A to FIG. 1C.

[0006] Different subcarriers in a same OFDM symbol are under same impact of a CPE. Phase errors on different subcarriers are different because of impact of white Gaussian noise. Therefore, in frequency domain, a plurality of estimated phase noise values are obtained by using a specific quantity of phase noise reference signals, and the plurality of estimated phase noise values are averaged to obtain a CPE, to reduce the impact of the white Gaussian noise to a greatest extent. Theoretically, a larger quantity of phase noise reference signals indicates a better averaging effect and a more accurately estimated CPE. In time domain, because phase noise varies

discontinuously, and there is no linear relationship between different symbols, performance is poorer if time domain pilots are sparser. In addition, a larger quantity of phase noise reference signals indicates more occupied time-frequency resources and higher overheads. Therefore, a compromise needs to be made between performance and overheads to determine the quantity of phase noise reference signals.

5 [0007] The prior art provides a phase tracking reference signal (the reference signal may also be referred to as a pilot) design solution, as shown in FIG. 2A-1 and FIG. 2A-2 and FIG. 2B-1 and FIG. 2B-2. A demodulation reference signal (Demodulation Reference Signal, DMRS) and a phase compensation reference signal (Phase compensation Reference Signal, PCRS) (which may also be referred to as a phase tracking reference signal (Phase tracking Reference Signal, PTRS), and the PCRS and the PTRS are not uniformly named in the industry currently and are collectively referred to as the PTRS subsequently for ease of description in the present invention) are used to complete channel estimation, phase noise estimation, and data demodulation together for both uplink and downlink. The DMRS is used for channel estimation and data demodulation, and the PTRS is used for tracking a residual phase error. There are a plurality of ports for the DMRS and the PTRS. A same antenna port is used for the PTRS and the DMRS in uplink, and a plurality of ports for the DMRS correspond to a same PTRS port in downlink. In time domain, PTRSs are consecutively mapped, to be specific, a PTRS is mapped to each symbol after the DMRS. In frequency domain, a frequency division manner is used between different ports. A time domain density and a frequency domain density are set to fixed values (an uplink density is $1/96$, and a downlink density is $1/48$). A quantity of reference signals increases as an effective bandwidth increases. When a data bandwidth is relatively small, there are a relatively small quantity of reference signals, and when the data bandwidth is less than four RBs, no PTRS is mapped, as shown in FIG. 2A-1 and FIG. 2A-2 and FIG. 2B-1 and FIG. 2B-2.

15 20 25 30 [0008] In addition, 2-bit and 1-bit downlink control information (Downlink Control Information, DCI) or uplink control information (Uplink Control Information, UCI) are respectively used for downlink and uplink, to indicate PTRS-related configurations. The downlink is used as an example. The 2-bit DCI is used to indicate whether a base station is to send a PTRS and which port is used if the base station is to send the PTRS. Details are shown in Table 1.

Table 1

Bits	Configuration information
00	Send no PTRS
01	Send a PTRS by using a port 60
10	Send a PTRS by using a port 61
11	Send a PTRS by using a port 60 and a port 61

[0009] The prior art has the following disadvantages: PTRSs are consecutive in time domain, and a frequency division manner is used for a plurality of ports in frequency domain. Also, a time domain density and a frequency domain density are fixed values, and a relatively large quantity of subcarriers are occupied and overheads are relatively high when a data bandwidth is large. In addition, the prior art is not flexible enough because the fixed time domain density and the fixed frequency domain density are used for different scenarios such as different phase noise levels and different moving speeds.

SUMMARY

[0010] Embodiments of the present invention provide a reference signal configuration method. This can reduce resource overheads, is more flexible, and better fits requirements of different future 5G scenarios in comparison with the prior art.

[0011] According to a first aspect, a reference signal configuration method is provided, including: mapping a phase tracking reference signal (PTRS) to one or more orthogonal frequency division multiplexing (orthogonal frequency division multiplexing, OFDM) symbols based on information about a correspondence between the PTRS and one or more of a modulation and coding scheme (Modulation and Coding Scheme, MCS), a subcarrier spacing (subcarrier spacing, SC), and a bandwidth (bandwidth, BW); and sending the one or more OFDM symbols to which the PTRS is mapped to a receive device.

[0012] In a possible design, the method further includes: determining to map the phase tracking reference signal (PTRS) to the one or more OFDM symbols.

[0013] In another possible design, the determining to map the phase tracking

reference signal (PTRS) to the one or more OFDM symbols specifically includes: when the MCS meets a preset condition, determining to map the PTRS to the one or more OFDM symbols.

5 [0014] In another possible design, the determining to map the PTRS to the one or more OFDM symbols specifically includes: when the bandwidth meets a preset condition and the MCS meets a preset condition, determining to map the PTRS to the one or more OFDM symbols.

[0015] In another possible design, the method further includes: preconfiguring or pre storing information about a correspondence between the SC and/or the MCS and a PTRS time domain density, where the PTRS time domain density is used to indicate that one PTRS is mapped to every several OFDM symbols in time domain.

[0016] In another possible design, a correspondence between the SC and the PTRS time domain density is:
different SCs correspond to different PTRS time domain densities, or
15 different SC intervals correspond to different PTRS time domain densities.

[0017] In another possible design, a correspondence between the MCS and the PTRS time domain density is:
different MCSs correspond to different PTRS time domain densities, or
different MCS intervals correspond to different PTRS time domain densities.

20 [0018] In another possible design, the method further includes: preconfiguring or pre storing a correspondence between the bandwidth and a quantity of PTRS frequency domains.

[0019] In another possible design, the correspondence is: different bandwidth intervals correspond to different quantities of PTRS frequency domains.

25 [0020] In another possible design, the method further includes: preconfiguring or pre storing a correspondence between the bandwidth and a PTRS frequency domain density, where the PTRS frequency domain density is used to indicate that one PTRS is mapped to every several subcarriers in frequency domain.

[0021] In another possible design, the correspondence is: different bandwidth intervals correspond to different PTRS frequency domain densities.

[0022] In another possible design, the method further includes: preconfiguring or pre storing a correspondence between the MCS and a quantity of PTRS frequency domains.

[0023] In another possible design, the correspondence is: different MCS intervals correspond to different quantities of PTRS frequency domains.

[0024] In another possible design, the method further includes: preconfiguring or prestoring a correspondence between the MCS and a PTRS frequency domain density.

5 [0025] In another possible design, the correspondence is: different MCS intervals correspond to different quantities of PTRS frequency domains.

[0026] In another possible design, the method further includes: preconfiguring or prestoring a correspondence between both the MCS and the bandwidth and a quantity of PTRS frequency domains.

10 [0027] In another possible design, the method further includes: preconfiguring or prestoring a correspondence between both the MCS and the bandwidth and a PTRS frequency domain density.

[0028] In another possible design, the one or more OFDM symbols are some or all symbols of a physical downlink shared channel (physical downlink shared channel,

15 PDSCH) or a physical uplink shared channel (physical uplink shared channel, PUSCH).

[0029] In another possible design, the receive device is a terminal or a base station.

[0030] According to a second aspect, a reference signal configuration method is provided, including: receiving one or more OFDM symbols from a transmit device; and determining a PTRS from the one or more OFDM symbols based on information about a correspondence between the PTRS and one or more of a MCS, a SC, and a BW.

[0031] In a possible design, the determining a PTRS from the one or more OFDM symbols specifically includes:

obtaining a SC and/or a MCS of a current slot;

determining a PTRS time domain density based on preconfigured or prestored information about a correspondence between the SC and/or the MCS and the PTRS time domain density; and

30 determining a time-frequency location of the PTRS in the one or more OFDM symbols based on the PTRS time domain density and a preset rule.

[0032] In another possible design, the determining a PTRS from the one or more OFDM symbols specifically includes:

obtaining a bandwidth in a current network; and
determining the time-frequency location of the PTRS in the one or more OFDM symbols based on preconfigured or prestored information about a correspondence between the bandwidth and a quantity of PTRS frequency domains.

5 [0033] In another possible design, the determining a PTRS from the one or more OFDM symbols specifically includes:

obtaining a bandwidth in a current network; and
determining the time-frequency location of the PTRS in the one or more OFDM symbols based on preconfigured or prestored information about a
10 correspondence between the bandwidth and a PTRS frequency domain density.

[0034] In another possible design, the determining a PTRS from the one or more OFDM symbols specifically includes:

obtaining the MCS of the current slot;
obtaining a bandwidth in a current network;
15 determining a quantity of PTRS frequency domains or a PTRS frequency domain density based on a preconfigured or prestored correspondence between both the MCS and the bandwidth and the quantity of PTRS frequency domains or the PTRS frequency domain density; and
determining the time-frequency location of the PTRS in the one or more
20 OFDM symbols based on the quantity of PTRS frequency domains or the PTRS frequency domain density.

[0035] In another possible design, the transmit device is a base station or a terminal.

[0036] According to a third aspect, an embodiment of the present invention
25 further provides a transmit device, including: a processor, configured to map a PTRS to one or more OFDM symbols based on information about a correspondence between the PTRS and one or more of a MCS, a SC, and a BW; and a transceiver, configured to send the one or more OFDM symbols to which the PTRS is mapped to a receive device.

30 [0037] In a possible design, the processor is further configured to determine to map the PTRS to the one or more OFDM symbols.

[0038] In a possible design, the processor is specifically configured to: when the MCS meets a preset condition, determine to map the PTRS to the one or more OFDM symbols.

[0039] In another possible design, the processor is specifically configured to: when the bandwidth meets a preset condition and the MCS meets a preset condition, determine to map the PTRS to the one or more OFDM symbols.

5 [0040] In another possible design, the transmit device further includes a memory, where the memory is configured to prestore information about a correspondence between the SC and/or the MCS and a PTRS time domain density, where the PTRS time domain density is used to indicate that one PTRS is mapped to every several OFDM symbols in time domain.

10 [0041] In another possible design, a correspondence between the SC and the PTRS time domain density is:

different SCs correspond to different PTRS time domain densities, or different SC intervals correspond to different PTRS time domain densities.

[0042] In another possible design, a correspondence between the MCS and the PTRS time domain density is:

15 different MCSs correspond to different PTRS time domain densities, or different MCS intervals correspond to different PTRS time domain densities.

[0043] In another possible design, the transmit device further includes the memory, and the memory is configured to prestore a correspondence between the bandwidth and a quantity of PTRS frequency domains.

20 [0044] In another possible design, the correspondence is: different bandwidth intervals correspond to different quantities of PTRS frequency domains.

[0045] In another possible design, the transmit device further includes the memory, and the memory is configured to prestore a correspondence between the bandwidth and a PTRS frequency domain density.

25 [0046] In another possible design, the correspondence is: different bandwidth intervals correspond to different PTRS frequency domain densities.

[0047] In another possible design, the transmit device further includes the memory, and the memory is configured to prestore a correspondence between the MCS and a quantity of PTRS frequency domains.

30 [0048] In another possible design, the transmit device further includes the memory, and the memory is configured to prestore a correspondence between the MCS and a PTRS frequency domain density.

[0049] In another possible design, the transmit device further includes the

memory, and the memory is configured to prestore a correspondence between both the MCS and the bandwidth and a quantity of PTRS frequency domains.

[0050] In another possible design, the transmit device further includes the memory, and the memory is configured to prestore a correspondence between both the
5 MCS and the bandwidth and a PTRS frequency domain density.

[0051] In another possible design, the transmit device is a base station or a terminal.

[0052] In another possible design, the receive device is a terminal or a base station.

10 [0053] According to a fourth aspect, an embodiment of the present invention further provides a receive device, including: a transceiver, configured to receive one or more OFDM symbols from a transmit device; and a processor, configured to determine a PTRS from the one or more OFDM symbols based on information about a correspondence between the PTRS and one or more of a MCS, a SC, and a BW.

15 [0054] In a possible design, the processor is specifically configured to:
obtain a SC and/or a MCS of a current slot;
determine a PTRS time domain density based on preconfigured or prestored information about a correspondence between the SC and/or the MCS and the PTRS time domain density, where the PTRS time domain density is used to
20 indicate that one PTRS is mapped to every several OFDM symbols in time domain;
and

determine a time-frequency location of the PTRS in the one or more OFDM symbols based on the PTRS time domain density and a preset rule.

[0055] In another possible design, the processor is specifically configured to:
25 obtain a bandwidth in a current network; and
determine the time-frequency location of the PTRS in the one or more OFDM symbols based on preconfigured or prestored information about a correspondence between the bandwidth and a quantity of PTRS frequency domains.

[0056] In another possible design, the processor is specifically configured to:
30 obtain a bandwidth in a current network; and
determine the time-frequency location of the PTRS in the one or more OFDM symbols based on preconfigured or prestored information about a correspondence between the bandwidth and a PTRS frequency domain density.

[0057] In another possible design, the processor is specifically configured to:

obtain the MCS of the current slot;
obtain a bandwidth in a current network;
determine a quantity of PTRS frequency domains or a PTRS frequency domain density based on a preconfigured or prestored correspondence between both
5 the MCS and the bandwidth and the quantity of PTRS frequency domains or the PTRS frequency domain density; and
determine the time-frequency location of the PTRS in the one or more OFDM symbols based on the quantity of PTRS frequency domains or the PTRS frequency domain density.

10 [0058] In another possible design, the transmit device is a base station or a terminal.
[0059] In another possible design, the receive device is a terminal or a base station.
[0060] According to a fifth aspect, an embodiment of the present invention further
15 provides a communications system, including the transmit device according to the third aspect and/or the receive device according to the fourth aspect.
[0061] In the embodiments of the present invention, a correspondence between the PTRS and the subcarrier spacing or the modulation and coding scheme or the bandwidth is used to implicitly indicate the time-frequency location of the PTRS. In
20 comparison with the prior art, no explicit indication is required, and signaling overheads are reduced.

BRIEF DESCRIPTION OF DRAWINGS

[0062] To describe the technical solutions in the embodiments of the present invention or in the prior art more clearly, the following briefly describes the
25 accompanying drawings required for describing the embodiments or the prior art. Apparently, the accompanying drawings in the following description show merely some embodiments of the present invention, and a person of ordinary skill in the art may still derive other drawings from these accompanying drawings without creative efforts.

30 [0063] FIG. 1A shows constellation points at which 64QAM modulation signal is not affected by phase noise;
[0064] FIG. 1B shows constellation points at which 64QAM modulation signal is

affected by phase noise on a 2 GHz frequency band;

[0065] FIG. 1C shows constellation points at which 64QAM modulation signal is affected by phase noise on a 28 GHz frequency band;

[0066] FIG. 2A-1 and FIG. 2A-2 are a schematic diagram of an uplink phase tracking pilot solution in the prior art;

[0067] FIG. 2B-1 and FIG. 2B-2 are a schematic diagram of a downlink phase tracking pilot solution in the prior art;

[0068] FIG. 3 is a schematic diagram of a network architecture according to an embodiment of the present invention;

10 [0069] FIG. 4 is a schematic diagram of a reference signal design pattern according to an embodiment of the present invention;

[0070] FIG. 5 is a schematic diagram of a reference signal configuration method according to an embodiment of the present invention;

[0071] FIG. 6A is a schematic diagram of a PTRS time domain mapping according to an embodiment of the present invention;

[0072] FIG. 6B is a schematic diagram of another PTRS time domain mapping according to an embodiment of the present invention;

[0073] FIG. 7A is a schematic diagram of a PTRS frequency domain mapping according to an embodiment of the present invention;

20 [0074] FIG. 7B is a schematic diagram of another PTRS frequency domain mapping according to an embodiment of the present invention;

[0075] FIG. 7C is a schematic diagram of another PTRS frequency domain mapping according to an embodiment of the present invention;

[0076] FIG. 8 is a schematic structural diagram of a transmit device according to an embodiment of the present invention; and

25 [0077] FIG. 9 is a schematic structural diagram of a receive device according to an embodiment of the present invention.

DESCRIPTION OF EMBODIMENTS

[0078] FIG. 3 is a schematic architectural diagram of an application scenario according to an embodiment of the present invention. A network architecture shown in FIG. 3 mainly includes a base station 31 and a terminal 32. The base station 31 may communicate with the terminal 32 by using a millimeter-wave band of a low

frequency (mainly 6 GHz or below) or a relatively high frequency (6 GHz or above). For example, the millimeter-wave band may be 28 GHz, 38 GHz, or an enhanced bandwidth (E-band) band of a data plane with a relatively small coverage area, for example, a frequency band of 70 GHz or above. The terminal 32 in coverage of the
5 base station 31 may communicate with the base station 31 by using the millimeter-wave band of a low frequency or a relatively high frequency.

[0079] The terminal 32 in the present invention may communicate with one or more core networks by using a radio access network (Radio Access Network, RAN). The terminal 32 may be an access terminal, a subscriber unit, a subscriber station, a
10 mobile station, a mobile console, a remote station, a remote terminal, a mobile device, a user terminal, a terminal, a wireless communications device, a user agent, or a user apparatus. The access terminal may be a cellular phone, a cordless phone, a Session Initiation Protocol (Session Initiation Protocol, SIP) phone, a wireless local loop (Wireless Local Loop, WLL) station, a personal digital assistant (Personal Digital
15 Assistant, PDA), a handheld device having a wireless communication function, a computing device, another processing device connected to a wireless modem, an in-vehicle device, a wearable device, a terminal in a 5G network, or the like.

[0080] The base station 31 in the present invention may be a Wireless Fidelity (Wireless Fidelity, Wi-Fi) station, an eNodeB in LTE, or a base station in next
20 generation communication, for example, a 5G base station gNB, a small cell, a micro base station, or may be a relay node, an access point, an in-vehicle device, a wearable device, or the like operating on a high frequency band.

[0081] Reference signals designed in the embodiments of the present invention are shown in FIG. 4 (a horizontal axis indicates time domain, and a vertical axis
25 indicates frequency domain). In one transmission slot, a PTRS is mapped to one or more OFDM symbols at a specific time domain density and a specific frequency domain density. The PTRS is usually used to track a rapid channel change, for example, track changes of a carrier frequency offset (Carrier Frequency Offset, CFO), phase noise (Phase noise, PN), and a Doppler shift. The PTRS usually occupies
30 several subcarriers in frequency domain, and in time domain, may occupy all OFDM symbols to which the PTRS is to be mapped, or occupy some OFDM symbols at a specific interval, or occupy some OFDM symbols according to another rule. The rule may be specified in a standard and preconfigured or prestored on a transmit device and a receive device.

[0082] Optionally, the OFDM symbols to which the PTRS is to be mapped are all symbols on a physical downlink shared channel (Physical Downlink Shared Channel, PDSCH) or a physical uplink shared channel (Physical Uplink Shared Channel, PUSCH), or all OFDM symbols except an OFDM symbol to which a DMRS is to be mapped, or may be OFDM symbols occupied by another control channel. This is not limited in the present invention.

[0083] As shown in FIG. 5, an embodiment of the present invention provides a reference signal configuration method. The method includes the following steps.

[0084] S502. A transmit device maps a PTRS to one or more OFDM symbols based on information about a correspondence between the PTRS and one or more of a modulation and coding scheme (MCS), a bandwidth (BW), and a subcarrier spacing (SC).

[0085] S504. The transmit device sends the one or more OFDM symbols to which the PTRS is mapped to a receive device.

[0086] S506. The receive device receives the one or more OFDM symbols from the transmit device, and determines the PTRS from the one or more OFDM symbols based on the information about the correspondence between the PTRS and the one or more of the MCS, the BW, and the SC.

[0087] It should be understood that the transmit device mentioned in this embodiment of the present invention may be a base station or a terminal. When the transmit device is a base station, the receive device is a terminal; or when the transmit device is a terminal, the receive device is a base station.

[0088] Optionally, before step S502, the method further includes:

[0089] S501: Determine whether to map the phase tracking reference signal (PTRS).

[0090] Step S501 of determining whether to map the phase tracking reference signal (PTRS) specifically includes the following implementations.

[0091] In a possible implementation, when the modulation and coding scheme (MCS) meets a preset condition, it is determined to map the phase tracking reference signal (PTRS).

[0092] For example, when the MCS is less than a threshold M_0 , the transmit device maps no PTRS; or when the MCS is greater than a threshold M_0 , the transmit device maps the phase tracking reference signal to one or more OFDM symbols. M_0

indicates a threshold for determining whether to map the PTRS, M_0 is an integer greater than 0, and a larger MCS indicates a higher modulation and coding rate.

[0093] For example, a value of the modulation and coding scheme (MCS) is referred to as an MCS index. In LTE, the MCS is used to indicate a modulation order and a bit rate, and one MCS index corresponds to one modulation order and one bit rate. A 3GPP R14 protocol is used as an example. One MCS index corresponds to one modulation order and one transport block size (Transport Block Size, TBS), and a TBS index is a parameter corresponding to the bit rate, as shown in Table 2.

Table 2

10 **3GPP 36.213: Modulation, TBS index and redundancy version table for PUSCH**

MCS Index I_{MCS}	Modulation Order Q_m	TBS Index I_{TBS}	Redundancy Version $r_{v_{idx}}$
0	2	0	0
1	2	1	0
2	2	2	0
3	2	3	0
4	2	4	0
5	2	5	0
6	2	6	0
7	2	7	0
8	2	8	0
9	2	9	0
10	2	10	0
11	4	10	0
12	4	11	0
13	4	12	0
14	4	13	0
15	4	14	0
16	4	15	0

17	4	16	0
18	4	17	0
19	4	18	0
20	4	19	0
21	6	19	0
22	6	20	0
23	6	21	0
24	6	22	0
25	6	23	0
26	6	24	0
27	6	25	0
28	6	26	0
29	reserved		1
30			2
31			3

[0094] Therefore, comparison between the MCS and M0 mentioned in this embodiment of the present invention is actually comparison between I_{MCS} and M0 in Table 2, and M0 is an integer greater than 0.

5 [0095] It should be further understood that currently a specific value of I_{MCS} is not determined in a standard, an I_{MCS} value in the future may be different from that in existing LTE (for example, in Table 2). No limitation is imposed on the I_{MCS} value in this embodiment of the present invention.

[0096] In another possible implementation, it may be determined, based on both
10 the MCS and the bandwidth (BW), whether the phase tracking reference signal needs to be mapped. For example, when I_{MCS} is less than M0, or when I_{MCS} is less than M1 and the BW is less than a preset threshold B0, the transmit device maps no phase tracking information; otherwise, the transmit device needs to map phase tracking information to one or more OFDM symbols. M0 indicates a first threshold for determining whether to map the PTRS, M1 indicates a second threshold for determining whether to map the PTRS, and B0 indicates a BW threshold for determining whether to map the PTRS.
15

5 [0097] It should be understood that the thresholds M0, B0, and M1 mentioned above may be constants as specified in a standard, or may be dynamically adjusted. If the thresholds need to be dynamically adjusted, a base station side may actively initiate a threshold adjustment, or a terminal side may actively initiate an adjustment request.

[0098] For example, the base station may use higher layer signaling to instruct to adjust the MCS threshold M0, or instruct to adjust the MCS threshold M1 and the BW threshold B0, to adapt to different scenarios and conditions. For example, the MCS threshold M0, or the MCS threshold M1 and the BW threshold B0 are adjusted by using signaling in the following two manners:

[0099] In Manner 1, a new MCS threshold M0, or a new MCS threshold M1 and a new BW threshold B0 are directly configured by using higher layer signaling such as a radio resource control (Radio Resource Control, RRC) or Media Access Control control element (Media Access Control Control Element, MAC CE).

15 [0100] In Manner 2, a subset that includes a plurality of MCS thresholds is stored at a higher layer. Different MCS subsets represent different configuration solutions. A command for adjusting an MCS threshold upward or downward by L levels is configured by using higher layer signaling. The MCS threshold is correspondingly increased or decreased by L levels based on the command at a physical layer. L is an integer greater than or equal to 1. It should be understood that in this manner, the higher layer signaling may include a plurality of bits, one bit is used to indicate whether to increase or decrease the MCS threshold, and the other bits are used to indicate a specific level.

25 [0101] It should be noted that when the preset condition mentioned in the foregoing embodiment is not met, a PTRS-related operation is terminated; or when the preset condition mentioned in the foregoing embodiment is met, a PTRS time domain density and a PTRS frequency domain density need to be determined based on information provided in the following embodiment.

30 [0102] For step S502 of mapping a PTRS to one or more OFDM symbols based on information about a correspondence between the PTRS and one or more of a MCS, a BW, and a SC, it should be understood that before step S502, the transmit device needs to preconfigure or prestore the information about the correspondence between

the PTRS and the one or more of the MCS, the bandwidth (BW), and the SC.

[0103] Specifically, the information about the correspondence between the PTRS and the one or more of the MCS, the BW, and the SC may be directly specified in the standard and stored by the transmit device in a memory. Alternatively, before the PTRS is mapped, the transmit device preconfigures the information about the correspondence between the PTRS and the one or more of the MCS, the BW, and the SC.

[0104] Specifically, the information about the correspondence between the PTRS and the one or more of the MCS, the BW, and the SC includes two dimensions: time domain and frequency domain. The following separately provides descriptions from the two dimensions: time domain and frequency domain.

[0105] Time domain solution

[0106] In time domain, the PTRS may occupy all OFDM symbols to which the PTRS is to be mapped, or occupy, at a specific interval, some OFDM symbols to which the PTRS may be mapped, or occupy some OFDM symbols according to a preset rule.

[0107] One resource block (Resource Block, RB, including 12 resource elements (Resource Element, RE)) is used as an example. It is assumed that one transmission slot is 14 OFDM symbols (numbered from 0 to 13), and OFDM symbols to which the PTRS may be mapped are numbered from 3 to 13. For example, two specific embodiments are provided in FIG. 6A and FIG. 6B, and respectively correspond to an example in which the PTRS is mapped to all the OFDM symbols to which the PTRS may be mapped in time domain and an example in which the PTRS occupies only about half the OFDM symbols.

[0108] The base station preconfigures or prestores a table of a correspondence between a time domain density and the SC or the MCS, and then obtains PTRS time domain density configuration information of a current slot based on the table and SC information and MCS information of the current slot. The time domain density is used to indicate that one PTRS is mapped to every several OFDM symbols. For example, if the time domain density is $1/3$, it indicates that one PTRS is mapped to every three OFDM symbols, or if the time domain density is $1/4$, it indicates that one PTRS is mapped to every four OFDM symbols.

[0109] In this embodiment of the present invention, the receive device may determine the PTRS time domain density based on the SC and/or the MCS, and then

obtain the PTRS. In comparison with the prior art, no additional indication information is required to notify a receive end.

[0110] There are a plurality of mapping rules between the PTRS time domain density and the SC and/or the MCS. The following provides descriptions by using a plurality of embodiments.

[0111] Embodiment 1: Establish a one-to-one correspondence between subcarrier spacings (SCs) and time domain densities.

[0112] Specifically, a larger subcarrier spacing indicates a smaller PTRS time domain density, and this is represented by $\text{Density} = 1/\lfloor \text{SC}/\text{SC}_0/\alpha_0 \rfloor$ or $\text{Density} = 1/\lceil \text{SC}/\text{SC}_0/\alpha_0 \rceil$. Density indicates the time domain density. For example, if a value of Density is 1/3, it indicates that one PTRS is mapped to every three OFDM symbols. SC indicates a current subcarrier spacing, SC_0 is a reference subcarrier spacing, α_0 is a constant, and $\lfloor \ \rfloor$ and $\lceil \ \rceil$ respectively indicate rounding down and rounding up.

[0113] For example, $\text{SC}_0=60$ k, and $\alpha_0=1$. When $\text{SC}=60$ k, the PTRS time domain density is 1, when $\text{SC}=120$ k, the PTRS time domain density is 1/2, when $\text{SC}=240$ k, the PTRS time domain density is 1/4, and so on, as shown in Table 3.

Table 3

Subcarrier spacing	Time domain density
60 k	1
120 k	1/2
240 k	1/4
480 k	1/8

[0114] It should be understood that the time domain density is greater than or equal to 1/total quantity of symbols and less than or equal to 1. When the time domain density Density is greater than 1, Density is directly set to 1, to be specific, the PTRS is mapped to all symbols. When Density is less than 1/total quantity of symbols, Density is directly set to 1/total quantity of symbols, to be specific, the PTRS is

mapped to only one of the symbols. Herein the total quantity of symbols is a total quantity of symbols to which the PTRS may be mapped in one slot. Details are not described repeatedly below.

5 [0115] Further, when the time domain density is less than 1, for example, the time domain density is 1/5, and there are a total of 10 OFDM symbols, the PTRS needs to be mapped to two OFDM symbols, and the PTRS may be mapped to two of the symbols according to a preset rule. For example, the preset rule may be mapping the PTRS to first two symbols, or mapping the PTRS to a symbol 4 and a symbol 9, or mapping the PTRS based on an algorithm or a formula.

10 [0116] The preset rule may be prestored on the transmit device and the receive device. When obtaining the time domain density, the receive device may determine a specific time-frequency location of the PTRS according to the prestored rule.

15 [0117] Optionally, after a table of a correspondence between the subcarrier spacing and the time domain density is established, the time domain density may also be corrected based on the modulation and coding scheme (MCS). Specifically, the time domain density may be adjusted by correcting a value of α_0 . For example, MCSs may be classified into x levels, and x is greater than or equal to 1. Each MCS level corresponds to one value of α , as shown in Table 4. In this case, a system may obtain a PTRS time domain density of the current slot based on the preset table of the
20 correspondence between the SC and the time domain density with reference to the MCS level, as shown in Table 4.

Table 4

MCS level	0	1	...	X
MCS interval	[MCS ₀ , MCS ₁)	[MCS ₁ , MCS ₂)	...	[MCS _{x-1} , MCS _x)
Adjustment factor	α_0	α_1	...	α_x

25 [0118] It should be understood that MCS interval classification in Table 4 is merely an example, and intervals may be (MCS₀, MCS₁], (MCS₁, MCS₂], (MCS₂, MCS₃], and the like. This is not limited in the present invention.

[0119] A value of the MCS is a positive integer.

[0120] In this way, a corrected time domain density is $\text{Density} = 1/\lceil \text{SC}/\text{SC}_0/\alpha_0 \rceil$,

and the value of α_0 is no longer a constant, but corresponds to different α_0 , α_1 , and α_x based on different MCS intervals recorded in Table 4. In this case, a final time domain density is related to both the SC and the MCS.

[0121] In the configuration of Embodiment 1, after receiving the one or more OFDM symbols from the transmit device, the receive device may determine a time-frequency location of the PTRS in the one or more OFDM symbols in the following manner:

obtaining a subcarrier spacing (SC) and/or a modulation and coding scheme (MCS) of a current slot;

10 determining the PTRS time domain density based on preconfigured or prestored information about a correspondence between the subcarrier spacing (SC) and/or the modulation and coding scheme (MCS) and the PTRS time domain density, where the PTRS time domain density is used to indicate that one PTRS is mapped to every several OFDM symbols in time domain; and

15 determining the time-frequency location of the PTRS in the one or more OFDM symbols based on the PTRS time domain density and a preset rule.

[0122] Embodiment 2: Establish a one-to-one correspondence between time domain densities and SCs.

[0123] Specifically, SCs may be classified into K levels, each level corresponds to one SC interval, and a subcarrier spacing interval corresponding to a level k is $[SC_{k-1}, SC_k]$. In addition, one SC level corresponds to one time domain density. Table 5 provides a specific example for SC levels and time domain densities.

Table 5

SC level	1	2	3	...
SC interval	<60 k	[60 k, 120 k)	[120 k, 240 k)	...
Time domain density	1	1/2	1/4	...

25 [0124] Optionally, after a table of a correspondence between the SC and the time domain density is established, the preset table may be corrected based on the MCS.

[0125] Specifically, the time domain density may be adjusted by correcting the SC level. For example, MCSs may be classified into 2*x levels, and each MCS level

corresponds to one SC level correction amount, as shown in Table 6. For example, when a value of the MCS level is 0, the table of the correspondence between the SC and the time domain density is not corrected; or when a value of the MCS level is x , the SC level increases by x levels; or when a value of the MCS level is $-x$, the SC level decreases by x levels. A larger MCS indicates a larger time domain density. In this case, a system may obtain a PTRS time domain density of the current slot based on the preset table of the correspondence between the SC and the time domain density with reference to the MCS level, as shown in Table 6.

Table 6

MCS level	$-x$...	0	1	...	x
MCS interval	$[MCS_0,$ $MCS_1)$...	$[MCS_m,$ $MCS_{m+1})$	$[MCS_{m+1},$ $MCS_{m+2})$...	$[MCS_{x-1},$ $MCS_x)$
SC level correction amount	$-y$...	0	1	...	y

10

[0126] For example, based on Table 5, when the SC is 80 k and falls within an interval [60 k, 120 k), a corresponding time domain density is 1/2. With reference to Table 6, when a value of the MCS falls within an interval $[MCS_{m+1}, MCS_{m+2})$, a corresponding SC level correction amount is 1, and it indicates that an original SC level 2 is increased to an SC level 3. Based on Table 5, it can be learned that a corrected time domain density is 1/4.

15

[0127] Optionally, higher layer signaling may also be used to instruct to adjust a correspondence, in a solution, between an MCS level and an MCS interval corresponding to the MCS level and/or to adjust a correspondence between an SC level and an SC interval corresponding to the SC level, to adapt to a new scenario and condition.

20

[0128] For example, quantities or a quantity of levels by which the MCS level and/or the SC level shown in Table 5 or Table 6 are/is increased or decreased may be directly adjusted by using higher layer signaling.

25

[0129] In the configuration of Embodiment 2, after receiving the one or more OFDM symbols from the transmit device, the receive device may determine a

time-frequency location of the PTRS in the one or more OFDM symbols in the following manner:

obtaining a subcarrier spacing SC and/or a modulation and coding scheme (MCS) of a current slot;

5 determining the PTRS time domain density based on preconfigured or prestored information about a correspondence between the subcarrier spacing (SC) and/or the modulation and coding scheme (MCS) and the PTRS time domain density, where the PTRS time domain density is used to indicate that one PTRS is mapped to every several OFDM symbols in time domain; and

10 determining the time-frequency location of the PTRS in the one or more OFDM symbols based on the PTRS time domain density and a preset rule.

[0130] Frequency domain solution

[0131] For mapping of the PTRS in frequency domain, a table of a correspondence between the MCS and/or the BW and a quantity of subcarriers to which the PTRS is mapped in each OFDM symbol in frequency domain may be established according to a specific criterion, or a table of a correspondence between the frequency domain density and the MCS and/or the BW may be established according to a specific criterion. In this embodiment of the present invention, PTRS frequency domain configuration information may be indicated based on the MCS and/or the BW, and no additional indication information is required to notify a receive end.

[0132] There are a plurality of mapping rules between a PTRS frequency domain mapping pattern and the MCS and/or the BW. The following uses a plurality of embodiments for description.

25 **[0133]** In frequency domain, PTRSs occupy several subcarriers, and the PTRSs are evenly distributed or consecutively distributed on the transmission bandwidth. One resource block is used as an example. It is assumed that the PTRS is mapped to all OFDM symbols (3 to 13) in time domain. FIG. 7A, FIG. 7B, and FIG. 7C provide three specific embodiments in which PTRSs are evenly mapped in frequency domain and are mapped to adjacent subcarriers.

[0134] Embodiment 3: Establish a correspondence between the BW and a quantity of PTRS frequency domains.

[0135] For example, a correspondence table may be established according to a specific criterion, as shown in Table 7.

Table 7

BW level	0	1	2	...	K
BW	$<BW_0$	$[BW_0, BW_1)$	$[BW_1, BW_2)$...	$<BW_K$
Quantity of PTRS frequency domains	P_0	P_1	P_2	...	P_K

[0136] For example, when the bandwidth falls within an interval $[BW_0, BW_1)$, it can be learned from Table 7 that the quantity of PTRS frequency domains is P_1 . It is assumed that there are a total of 10 subcarriers in frequency domain, and a value of P_1 is 3, and it indicates that the PTRS occupies a total of three of the 10 subcarriers in frequency domain. The three subcarriers may be selected according to a preset rule. For example, the preset rule is selecting first three subcarriers, selecting last three subcarriers, selecting three of the subcarriers based on a formula or an algorithm, or mapping PTRSs to three of the 10 subcarriers at equal intervals.

[0137] The preset rule may be specified in the standard and preconfigured or prestored on the transmit device and the receive device.

[0138] In the configuration of Embodiment 3, after receiving the one or more OFDM symbols from the transmit device, the receive device may determine a time-frequency location of the PTRS in the one or more OFDM symbols in the following manner:

- obtaining a bandwidth in a current network; and
- determining the time-frequency location of the PTRS in the one or more OFDM symbols based on preconfigured or prestored information about a correspondence between the bandwidth and the quantity of PTRS frequency domains.

[0139] Embodiment 4: Establish a correspondence between the BW and a PTRS frequency domain density T.

[0140] The frequency domain density is used to indicate a PTRS density or the quantity of PTRS frequency domains on each scheduled bandwidth.

[0141] For example, a correspondence table is established according to a specific criterion, as shown in Table 8. For example, if the frequency domain density is equal to $1/12$, and the scheduled bandwidth is four RBs (the scheduled bandwidth is a known bandwidth allocated by the base station to the terminal), that is, 48 subcarriers (each RB includes 12 subcarriers), a total of four PTRSs ($48 * 1/12 = 4$) are mapped on

the scheduled bandwidth of four RBs. The four PTRSs may be mapped on the scheduled bandwidth at equal intervals, or may be mapped to four consecutive subcarriers, or may be mapped to four inconsecutive subcarriers through hashing according to another rule. Details are shown in Table 8.

5

Table 8

BW level	0	1	2	...	K
BW interval	<BW ₀	[BW ₀ , BW ₁)	[BW ₁ , BW ₂)	...	<BW _K
Frequency domain density	T ₀	T ₁	T ₂	...	T _K

[0142] Optionally, higher layer signaling may be used to instruct to adjust a correspondence, in a solution, between a BW level and a BW interval corresponding to the BW level. Specifically, the BW level may be directly increased or decreased by x levels through adjustment by using higher layer signaling, where x is an integer less than or equal to K.

[0143] In the configuration of Embodiment 4, after receiving the one or more OFDM symbols from the transmit device, the receive device may determine a time-frequency location of the PTRS in the one or more OFDM symbols in the following manner:

- obtaining a bandwidth in a current network; and
- determining the time-frequency location of the PTRS in the one or more OFDM symbols based on preconfigured or prestored information about a correspondence between the bandwidth and the PTRS frequency domain density.

[0144] Embodiment 5: Establish a one-to-one correspondence between both MCSs and BWs and quantities (K) of frequency domain pilots or frequency domain densities.

[0145] For example, BWs are classified into K levels (columns in Table 9), and MCSs are classified into M levels (rows in Table 9), to obtain a correspondence table of K*M dimensions, as shown in Table 9.

Table 9

BW/MCS	BW level		0	1	2	...	K-1
	MCS	BW	$<BW_0$	$[BW_0, BW_1)$	$[BW_1, BW_2)$...	$\geq BW_{K-1}$
0	$<MCS_0$		T_{11}	T_{12}	T_{13}	...	T_{1K}
1	$[MCS_0, MCS_1)$		T_{21}	T_{22}	T_{23}	...	T_{2K}
...
M-1	$\geq MCS_{m-1}$		T_{M1}	T_{M2}	T_{M3}	...	T_{MK}

[0146] For example, the scheduled bandwidth (BW) allocated by the base station to the terminal falls within an interval $[BW_1, BW_2)$, and a value of the MCS used by the base station falls within an interval $[MCS_0, MCS_1)$. It can be learned, based on mapping information in Table 9, that the quantity of PTRS frequency domains or the PTRS frequency domain density is T_{23} . T_{23} herein may be a decimal or an integer.

[0147] If T_{23} indicates the quantity of PTRS frequency domains, an integer obtained after T_{23} is rounded up or rounded down indicates the quantity of PTRS frequency domains.

[0148] If T_{23} indicates the PTRS frequency domain density, T_{23} may not be rounded.

[0149] Further, when T_{23} indicates the quantity of PTRS frequency domains, the receive device may determine, according to a preset rule or a preset algorithm, a specific subcarrier to which the PTRS is mapped.

[0150] For example, the preset rule may be mapping T_{23} PTRSs at equal intervals starting from a first subcarrier, or consecutively mapping T_{23} PTRSs starting from a fifth subcarrier, or mapping one PTRS every other subcarrier starting from a first subcarrier until all PTRSs are mapped.

[0151] The preset rule or the preset algorithm may be directly specified in the standard and prestored or preconfigured on the transmit device and the receive device.

[0152] Optionally, higher layer signaling may be used to instruct to adjust a correspondence, in a solution, between a BW level and a BW interval corresponding to the BW level, or instruct to adjust a correspondence, in a solution, between an MCS level and an MCS interval corresponding to the MCS level, or instruct to adjust both a

correspondence between a BW level and a BW interval corresponding to the BW level and a correspondence between an MCS level and an MCS interval corresponding to the MCS level. The BW level and/or the MCS level may be directly increased or decreased by X or Y levels through configuration by using higher layer signaling. X and Y are integers greater than 0.

5 [0153] In the configuration of Embodiment 5, after receiving the one or more OFDM symbols from the transmit device, the receive device may determine a time-frequency location of the PTRS in the one or more OFDM symbols in the following manner:

- 10 obtaining a modulation and coding scheme (MCS) in a current network;
- obtaining a bandwidth in the current network;
- determining a quantity of PTRS frequency domains or a PTRS frequency domain density based on a preconfigured or prestored correspondence between both the MCS and the bandwidth and the quantity of PTRS frequency domains or the
- 15 PTRS frequency domain density; and
- determining the time-frequency location of the PTRS in the one or more OFDM symbols based on the quantity of PTRS frequency domains or the PTRS frequency domain density.

[0154] According to the method in the present invention, the receive device may obtain PTRS-related configuration information by using information such as the MCS, 20 the BW, and the SC. This can reduce signaling overheads in comparison with the prior art.

[0155] FIG. 8 is a schematic block diagram of a transmit device 800 according to another embodiment of the present invention. The transmit device 800 includes a processor 810, a memory 820, a transceiver 830, an antenna 840, a bus 850, and a user interface 860. 25

[0156] Specifically, the processor 810 controls an operation of the transmit device 800, and the processor may be a general-purpose processor, a digital signal processor, a dedicated integrated circuit, a field programmable gate array, or another programmable logic device. 30

[0157] The transceiver 830 includes a transmitter 832 and a receiver 834, the transmitter 832 is configured to transmit a signal, and the receiver 834 is configured to receive a signal. There may be one or more antennas 840. The transmit device 800

may further include the user interface 860 such as a keyboard, a microphone, a loudspeaker, and/or a touchscreen. The user interface 860 may transfer content and a control operation to the transmit device 800.

5 [0158] All components of the transmit device 800 are coupled together by using the bus 850. In addition to a data bus, the bus 850 includes a power bus, a control bus, and a status signal bus. However, for clarity of description, various buses are marked as the bus 850 in the figure. It should be noted that the foregoing descriptions about the transmit device structure may be applied to the embodiments of the present invention.

10 [0159] The memory 820 may include a read-only memory (Read-Only Memory, ROM), a random access memory (Random Access Memory, RAM), or another type of dynamic storage device that may store information and an instruction, or may be a magnetic disk storage. The memory 820 may be configured to store an instruction for implementing the related method provided in the embodiments of the present invention. It may be understood that an executable instruction is programmed or
15 loaded into at least one of the processor 810, a cache, and a long term memory of the transmit device 800.

[0160] In a specific embodiment, the processor 810 is configured to map a PTRS to one or more OFDM symbols based on information about a correspondence between
20 the PTRS and one or more of a modulation and coding scheme (MCS), a bandwidth (BW), and a subcarrier spacing (SC).

[0161] The transceiver 830 is configured to send the one or more OFDM symbols to which the PTRS is mapped to a receive device.

25 [0162] Optionally, the processor 810 is further configured to determine to map the phase tracking reference signal (PTRS) to the one or more orthogonal frequency division multiplexing (OFDM) symbols.

[0163] Further, the processor 810 is specifically configured to: when the MCS meets a preset condition, determine to map the PTRS to the one or more OFDM symbols.

30 [0164] Further, the processor 810 is specifically configured to:
when the bandwidth meets a preset condition and the MCS meets a preset condition, determine to map the PTRS to the one or more OFDM symbols.

[0165] Optionally, the memory 820 is configured to prestore information about a correspondence between the subcarrier spacing and/or the MCS and a PTRS time domain density, where the PTRS time domain density is used to indicate that one PTRS is mapped to every several OFDM symbols. For a specific correspondence, refer to the descriptions in Embodiment 1 and Embodiment 2, and details are not described herein again.

[0166] Optionally, the memory 820 is configured to prestore a correspondence between the bandwidth and a quantity of PTRS frequency domains or a PTRS frequency domain density.

[0167] Optionally, the memory 820 is configured to prestore a correspondence between the MCS and a quantity of PTRS frequency domains or a PTRS frequency domain density.

[0168] Optionally, the memory 820 is configured to prestore a correspondence between both the MCS and the bandwidth and a quantity of PTRS frequency domains or a PTRS frequency domain density.

[0169] It should be understood that the transmit device shown in FIG. 8 may be a base station or a terminal.

[0170] It should be further understood that the transmit device shown in FIG. 8 corresponds to the transmit device in the foregoing method embodiment, and descriptions about all details of the method embodiment may be used to explain the apparatus embodiment of the transmit device. For details of interaction between the transmit device and the receive device, refer to the foregoing description. Details are not described again.

[0171] FIG. 9 is a schematic block diagram of a receive device 900 according to another embodiment of the present invention. The receive device 900 includes a processor 910, a memory 920, a transceiver 930, an antenna 940, a bus 950, and a user interface 960.

[0172] Specifically, the processor 910 controls an operation of the receive device 900, and the processor may be a general-purpose processor, a digital signal processor, a dedicated integrated circuit, a field programmable gate array, or another programmable logic device.

[0173] The transceiver 930 includes a transmitter 932 and a receiver 934, the transmitter 932 is configured to transmit a signal, and the receiver 934 is configured to receive a signal. There may be one or more antennas 940. The receive device 900

may further include the user interface 960 such as a keyboard, a microphone, a loudspeaker, and/or a touchscreen. The user interface 960 may transfer content and a control operation to the receive device 900.

5 [0174] All components of the receive device 900 are coupled together by using the bus 950. In addition to a data bus, the bus 950 includes a power bus, a control bus, and a status signal bus. However, for clarity of description, various buses are marked as the bus 950 in the figure. It should be noted that the foregoing descriptions about a network element structure may be applied to the embodiments of the present invention.

10 [0175] The memory 920 may include a read-only memory (Read-Only Memory, ROM), a random access memory (Random Access Memory, RAM), or another type of dynamic storage device that may store information and an instruction, or may be a magnetic disk storage. The memory 920 may be configured to store an instruction for implementing the related method provided in the embodiments of the present
15 invention. It may be understood that an executable instruction is programmed or loaded into at least one of the processor 910, a cache, and a long term memory of the receive device 900. In a specific embodiment, the memory is configured to store computer executable program code. When the program code includes an instruction, and the processor executes the instruction, the instruction enables the receive device
20 to perform the following operations:

[0176] The transceiver 930 is configured to receive one or more orthogonal frequency division multiplexing (OFDM) symbols from a transmit device.

25 [0177] The processor 910 is configured to determine a phase tracking reference signal (PTRS) from the one or more OFDM symbols based on information about a correspondence between the PTRS and one or more of a modulation and coding scheme (MCS), a bandwidth (BW), and a subcarrier spacing (SC).

[0178] Optionally, the processor 910 is specifically configured to:
obtain a subcarrier spacing (SC) and/or a modulation and coding scheme (MCS) of a current slot;
30 determine a PTRS time domain density based on preconfigured or prestored information about a correspondence between the subcarrier spacing and/or the MCS and the PTRS time domain density, where the PTRS time domain density is

used to indicate that one PTRS is mapped to every several OFDM symbols in time domain; and

determine a time-frequency location of the PTRS in the one or more OFDM symbols based on the PTRS time domain density and a preset rule.

5 [0179] Optionally, the processor 910 is specifically configured to:

obtain a bandwidth in a current network; and

determine the time-frequency location of the PTRS in the one or more OFDM symbols based on preconfigured or prestored information about a correspondence between the bandwidth and a quantity of PTRS frequency domains.

10 [0180] Optionally, the memory 920 is configured to prestore information about a correspondence between the subcarrier spacing or the MCS and a PTRS time domain density, where the PTRS time domain density is used to indicate that one PTRS is mapped to every several OFDM symbols.

[0181] Optionally, the processor 910 is specifically configured to:

15 obtain a bandwidth in a current network; and

determine the time-frequency location of the PTRS in the one or more OFDM symbols based on preconfigured or prestored information about a correspondence between the bandwidth and a PTRS frequency domain density.

[0182] Optionally, the processor 910 is specifically configured to:

20 obtain a modulation and coding scheme (MCS) in a current network;

obtain a bandwidth in the current network;

determine a quantity of PTRS frequency domains or a PTRS frequency domain density based on a preconfigured or prestored correspondence between both the modulation and coding scheme (MCS) and the bandwidth and the quantity of PTRS frequency domains or the PTRS frequency domain density; and

25 determine the time-frequency location of the PTRS in the one or more OFDM symbols based on the quantity of PTRS frequency domains or the PTRS frequency domain density.

[0183] Optionally, the memory 920 is configured to prestore a correspondence between the bandwidth and a quantity of PTRS frequency domains or a PTRS frequency domain density.

30 [0184] Optionally, the memory 920 is configured to prestore a correspondence between the MCS and a quantity of PTRS frequency domains or a PTRS frequency domain density.

[0185] Optionally, the memory 920 is further configured to prestore a correspondence between both the modulation and coding scheme (MCS) and the BW and a quantity of PTRS frequency domains.

5 [0186] Optionally, the memory 920 is further configured to prestore a correspondence between both the MCS and the BW and a PTRS frequency domain density.

[0187] For a specific implementation of performing operations by the processor included in the receive device, refer to corresponding steps performed by the receive device in the method embodiment. Details are not described again in this embodiment
10 of the present invention.

[0188] It should be understood that the receive device shown in FIG. 9 corresponds to the receive device in the foregoing method embodiment, and descriptions about all details of the method embodiment may be used to explain the apparatus embodiment of the receive device. For details of interaction between the
15 transmit device and the receive device, refer to the foregoing description. Details are not described again.

[0189] An embodiment of the present invention further provides a computer storage medium, configured to store a computer software instruction used by a transmit device. The computer software instruction includes a program designed for
20 performing the foregoing embodiment.

[0190] An embodiment of the present invention further provides a computer storage medium, configured to store a computer software instruction used by the foregoing receive device. The computer software instruction includes a program designed for performing the foregoing embodiment.

25 [0191] An embodiment of the present invention further provides a communications network system, including a transmit device and a receive device.

[0192] The transmit device is configured to perform steps performed by the transmit device in the method embodiment.

[0193] The receive device is configured to perform steps performed by the receive
30 device in the method embodiment.

[0194] For a process of interaction between the transmit device and the receive device, refer to the descriptions in the method embodiment, and details are not described herein again.

[0195] In the embodiments of the present invention, the subcarrier spacing or the

modulation and coding scheme or the bandwidth is used to implicitly indicate the time-frequency location of the PTRS, so that no explicit DCI indication is required. In comparison with the prior art, signaling overheads are reduced.

5 [0196] In the specification, claims, and accompanying drawings of the present invention, the terms "first", "second", "third", "fourth", and the like are intended to distinguish between different objects but do not indicate a particular order. Moreover, the terms "include", "contain", and any other variant thereof are intended to cover a non-exclusive inclusion. For example, a process, a method, a system, a product, or a device that includes a series of steps or units is not limited to the listed steps or units,
10 but optionally further includes an unlisted step or unit, or optionally further includes another inherent step or unit of the process, the method, the system, the product, or the device.

[0197] All or some of the foregoing embodiments may be implemented by using software, hardware, firmware, or any combination thereof. When software is used to
15 implement the embodiments, all or some of the embodiments may be implemented in a form of a computer program product. The computer program product includes one or more computer instructions. When the computer program instructions are loaded and executed on a computer, the procedures or functions according to the embodiments of the present invention are all or partially generated. The computer
20 may be a general-purpose computer, a dedicated computer, a computer network, or another programmable apparatus. The computer instructions may be stored in a computer-readable storage medium or may be transmitted from a computer-readable storage medium to another computer-readable storage medium. For example, the computer instructions may be transmitted from a website, computer, server, or data
25 center to another website, computer, server, or data center in a wired (for example, a coaxial cable, an optical fiber, or a digital subscriber line (DSL)) or wireless (for example, infrared, radio, or microwave) manner. The computer-readable storage medium may be any usable medium accessible by the computer, or a data storage device, such as a server or a data center, integrating one or more usable media. The
30 usable medium may be a magnetic medium (for example, a floppy disk, a hard disk, or a magnetic tape), an optical medium (for example, a DVD), a semiconductor medium (for example, a solid state disk Solid State Disk, (SSD)), or the like.

[0198] What are disclosed above are merely examples of the embodiments of the present invention, and certainly are not intended to limit the scope of the claims of the

present invention. Therefore, equivalent variations made in accordance with the claims of the present invention shall fall within the scope of the present invention.

CLAIMS

What is claimed is:

1. A reference signal configuration method, comprising:
 - mapping, by a communication device, a phase tracking reference signal (PTRS)
5 to one or more orthogonal frequency division multiplexing (OFDM) symbols based on information about a correspondence between a modulation and coding scheme (MCS) and a PTRS time domain density and information about a correspondence between a scheduled bandwidth (BW) and a PTRS frequency domain density; and
 - 10 sending, by the communication device, the one or more OFDM symbols to which the PTRS is mapped to another communication device;
 - wherein before the mapping, the method further comprises:
 - preconfiguring or prestoring the information about the correspondence between the MCS and the PTRS time domain density and the information about the correspondence between the scheduled bandwidth and the PTRS frequency domain
15 density;
 - wherein the correspondence between the MCS and the PTRS time domain density comprises:
 - different MCS intervals correspond to different PTRS time domain densities;
 - wherein the correspondence between the scheduled bandwidth and the PTRS
20 frequency domain density comprises:
 - different scheduled bandwidth intervals correspond to different PTRS frequency domain densities.
2. The method according to claim 1, further comprising:
 - 25 when the MCS is less than a threshold M_0 , not mapping the phase tracking reference signal (PTRS).
3. The method according to claim 2, further comprising:
 - receiving the MCS threshold M_0 by using higher layer signaling.
30
4. A reference signal configuration method, comprising:
 - receiving, by a communication device, one or more orthogonal frequency

division multiplexing (OFDM) symbols from another communication device; and

determining, by the communication device, a phase tracking reference signal (PTRS) from the one or more orthogonal frequency division multiplexing (OFDM) symbols based on information about a correspondence between a modulation and coding scheme (MCS) and a PTRS time domain density and information about a
5 correspondence between a scheduled bandwidth (BW) and a PTRS frequency domain density;

wherein before the receiving, the method further comprises:

preconfiguring or prestoring the information about the correspondence between
10 the MCS and the PTRS time domain density and the information about the correspondence between the scheduled bandwidth and the PTRS frequency domain density;

wherein the correspondence between the MCS and the PTRS time domain density comprises:

15 different MCS intervals correspond to different PTRS time domain densities;

wherein the correspondence between the scheduled bandwidth and the PTRS frequency domain density comprises:

different scheduled bandwidth intervals correspond to different PTRS frequency domain densities.

20
5. The method according to claim 4, wherein the determining a PTRS from the one or more OFDM symbols specifically comprises:

obtaining a modulation and coding scheme (MCS) of a current slot;

determining a time domain density of the PTRS based on the information about
25 the correspondence between the modulation and coding scheme (MCS) and the PTRS time domain density; and

determining a time-frequency location of the PTRS in the one or more OFDM symbols based on the determined time domain density of the PTRS and a predetermined rule.

30
6. The method according to claim 4, wherein the determining a PTRS from the one or more OFDM symbols specifically comprises:

obtaining a scheduled bandwidth in a current network; and

determining a time-frequency location of the PTRS in the one or more OFDM

symbols based on the information about the correspondence between the scheduled bandwidth and the PTRS frequency domain density.

7. A communications apparatus, comprising:

- 5 a processor, configured to map a phase tracking reference signal (PTRS) to one or more orthogonal frequency division multiplexing (OFDM) symbols based on information about a correspondence between a modulation and coding scheme (MCS) and a PTRS time domain density and information about a correspondence between a scheduled bandwidth (BW) and a PTRS frequency domain density; and
- 10 a transmitter, configured to send the one or more OFDM symbols to which the PTRS is mapped to another communication device;
- a memory, configured to prestore the information about the correspondence between the MCS and the PTRS time domain density and the information about the correspondence between the scheduled bandwidth and the PTRS frequency domain
- 15 density;
- wherein the correspondence between the MCS and the PTRS time domain density comprises:
- different MCS intervals correspond to different PTRS time domain densities;
- wherein the correspondence between the scheduled bandwidth and the PTRS
- 20 frequency domain density comprises:
- different scheduled bandwidth intervals correspond to different PTRS frequency domain densities.

8. The communications apparatus according to claim 7, wherein the processor is

25 configured to:

when the MCS is less than a threshold M_0 , determine not to map the PTRS.

9. The communications apparatus according to claim 8, further comprising:

a receiver, configured to receive the MCS threshold M_0 by using higher layer

30 signaling.

10. The communications apparatus according to claim 7, wherein the processor is further configured to preconfigure the information about the correspondence between the MCS and the PTRS time domain density and the correspondence

between the scheduled bandwidth and the PTRS frequency domain density.

11. A communications apparatus, comprising:

5 a receiver, configured to receive one or more orthogonal frequency division multiplexing (OFDM) symbols; and

a processor, configured to determine a phase tracking reference signal (PTRS) from the one or more orthogonal frequency division multiplexing (OFDM) symbols based on information about a correspondence between a modulation and coding scheme (MCS) and a PTRS time domain density and information about a
10 correspondence between a scheduled bandwidth (BW) and a PTRS frequency domain density;

a memory, configured to prestore the information about the correspondence between the MCS and the PTRS time domain density and the information about the correspondence between the scheduled bandwidth and the PTRS frequency domain
15 density;

wherein the correspondence between the MCS and the PTRS time domain density comprises:

different MCS intervals correspond to different PTRS time domain densities;

20 wherein the correspondence between the scheduled bandwidth and the PTRS frequency domain density comprises:

different scheduled bandwidth intervals correspond to different PTRS frequency domain densities.

12. The communications apparatus according to claim 11, wherein the processor
25 is further configured to:

obtain a modulation and coding scheme (MCS) of a current slot;

determine a time domain density of the PTRS based on the information about the correspondence between the modulation and coding scheme (MCS) and the PTRS time domain density; and

30 determine a time-frequency location of the PTRS in the one or more OFDM symbols based on the determined time domain density of the PTRS and a predetermined rule.

13. The communications apparatus according to claim 11, wherein the processor

is further configured to:

obtain a scheduled bandwidth in a current network; and

determine a time-frequency location of the PTRS in the one or more OFDM symbols based on the information about the correspondence between the scheduled
5 bandwidth and the PTRS frequency domain density.

14. The communications apparatus according to claim 11, wherein the processor is further configured to preconfigure the information about the correspondence between the MCS and the PTRS time domain density and the correspondence
10 between the scheduled bandwidth and the PTRS frequency domain density.

15. A communications system, comprising the communications apparatus according to claims 7 to 10 and the communications apparatus according to claims 11 to 14.

15

16. A computer-readable storage medium, configured to store a computer readable code, wherein when the computer readable code runs on a computer, the computer performs the method according to any one of claims 1 to 3 or 4 to 6.

20 17. A computer program product comprising computer readable code, wherein when the computer readable code runs on a computer, the computer performs the method according to any one of claims 1 to 3 or 4 to 6.

18. An apparatus, comprising:

25

a memory storing computer readable code; and

a processor, configured to execute the computer readable code to make the apparatus implement the method according to any one of claims 1 to 3 or 4 to 6.

19. A communication device, comprising:

30

means for mapping a phase tracking reference signal (PTRS) to one or more orthogonal frequency division multiplexing (OFDM) symbols based on information about a correspondence between a modulation and coding scheme (MCS) and a PTRS time domain density and information about a correspondence between a scheduled

bandwidth (BW) and a PTRS frequency domain density;

means for sending the one or more OFDM symbols to which the PTRS is mapped to another communication device;

5 means for preconfiguring or prestoring the information about the correspondence between the MCS and the PTRS time domain density and the information about the correspondence between the scheduled bandwidth and the PTRS frequency domain density;

wherein the correspondence between the MCS and the PTRS time domain density comprises:

10 different MCS intervals correspond to different PTRS time domain densities;

wherein the correspondence between the scheduled bandwidth and the PTRS frequency domain density comprises:

different scheduled bandwidth intervals correspond to different PTRS frequency domain densities.

15

20. The communication device according to claim 19, further comprising:

means for determining not to map the phase tracking reference signal (PTRS) if the MCS is less than a threshold M_0 .

20 21. The communication device according to claim 20, further comprising:

means for receiving the MCS threshold M_0 by using higher layer signaling.

22. A communication device, comprising:

25 means for receiving one or more orthogonal frequency division multiplexing (OFDM) symbols from another communication device; and

means for determining a phase tracking reference signal (PTRS) from the one or more orthogonal frequency division multiplexing (OFDM) symbols based on information about a correspondence between a modulation and coding scheme (MCS) and a PTRS time domain density and information about a correspondence between a scheduled bandwidth (BW) and a PTRS frequency domain density;

30

means for preconfiguring or prestoring the information about the correspondence between the MCS and the PTRS time domain density and the information about the correspondence between the scheduled bandwidth and the PTRS frequency domain density;

wherein the correspondence between the MCS and the PTRS time domain density comprises:

different MCS intervals correspond to different PTRS time domain densities;

wherein the correspondence between the scheduled bandwidth and the PTRS
5 frequency domain density comprises:

different scheduled bandwidth intervals correspond to different PTRS frequency domain densities.

23. The communication device according to claim 22, wherein means for the
10 determining a PTRS from the one or more OFDM symbols specifically comprises:

means for obtaining a modulation and coding scheme (MCS) of a current slot;

means for determining a time domain density of the PTRS based on the
information about the correspondence between the modulation and coding scheme
(MCS) and the PTRS time domain density; and

15 means for determining a time-frequency location of the PTRS in the one or more
OFDM symbols based on the determined time domain density of the PTRS and a
predetermined rule.

24. The communication device according to claim 22, wherein means for the
20 determining a PTRS from the one or more OFDM symbols specifically comprises:

means for obtaining a scheduled bandwidth in a current network; and

means for determining a time-frequency location of the PTRS in the one or more
OFDM symbols based on the information about the correspondence between the
scheduled bandwidth and the PTRS frequency domain density.

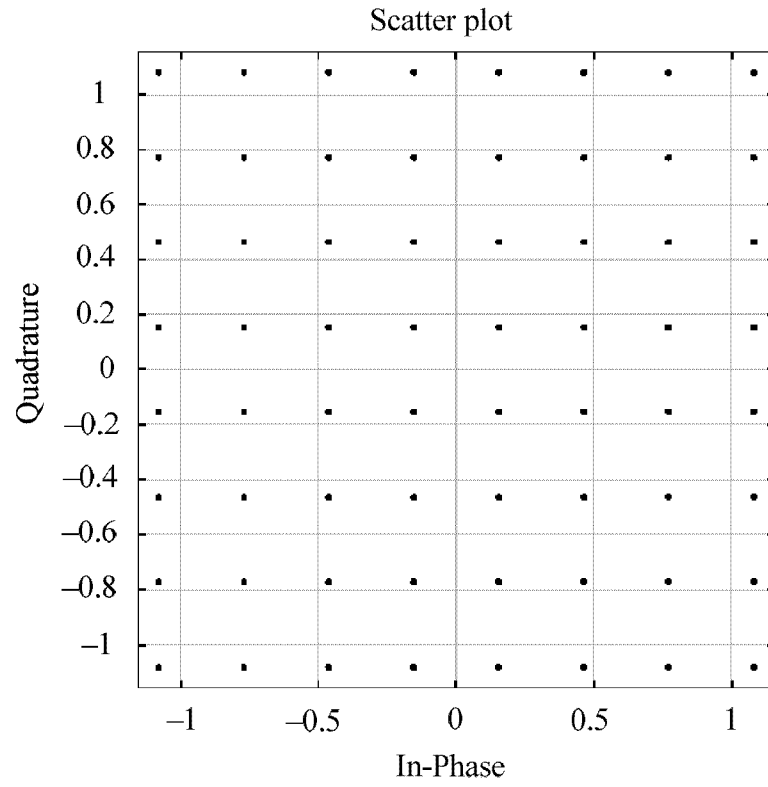

FIG. 1A (PRIOR ART)

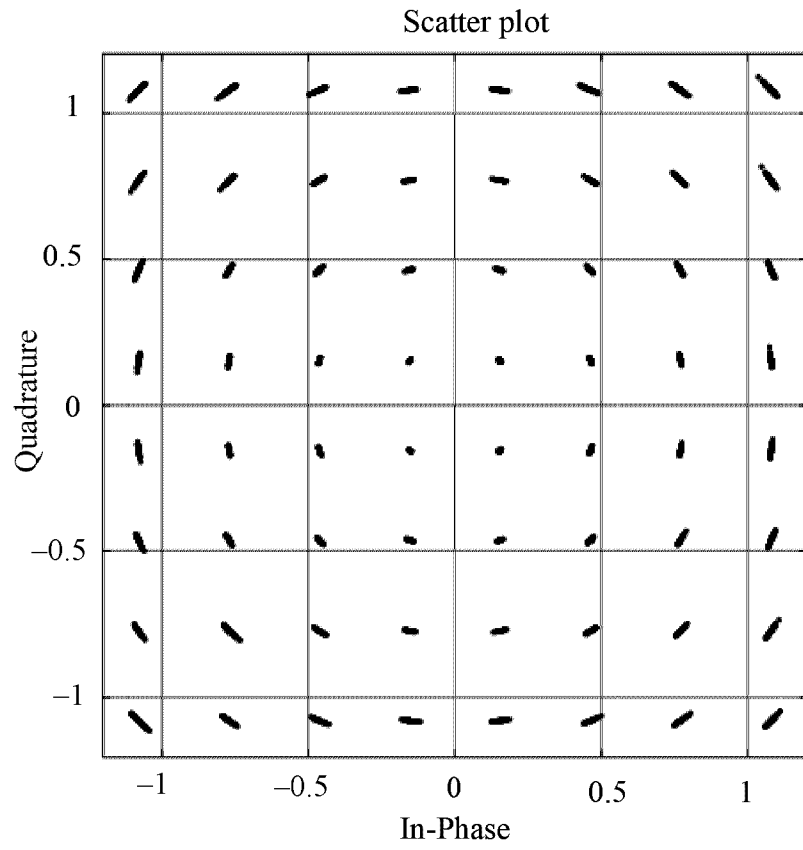

FIG. 1B (PRIOR ART)

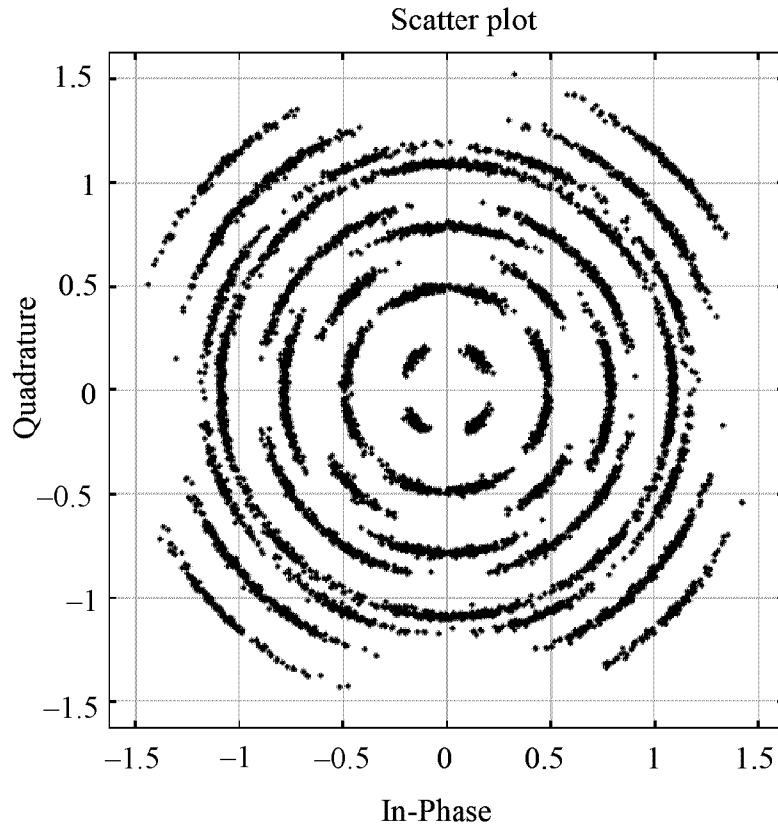
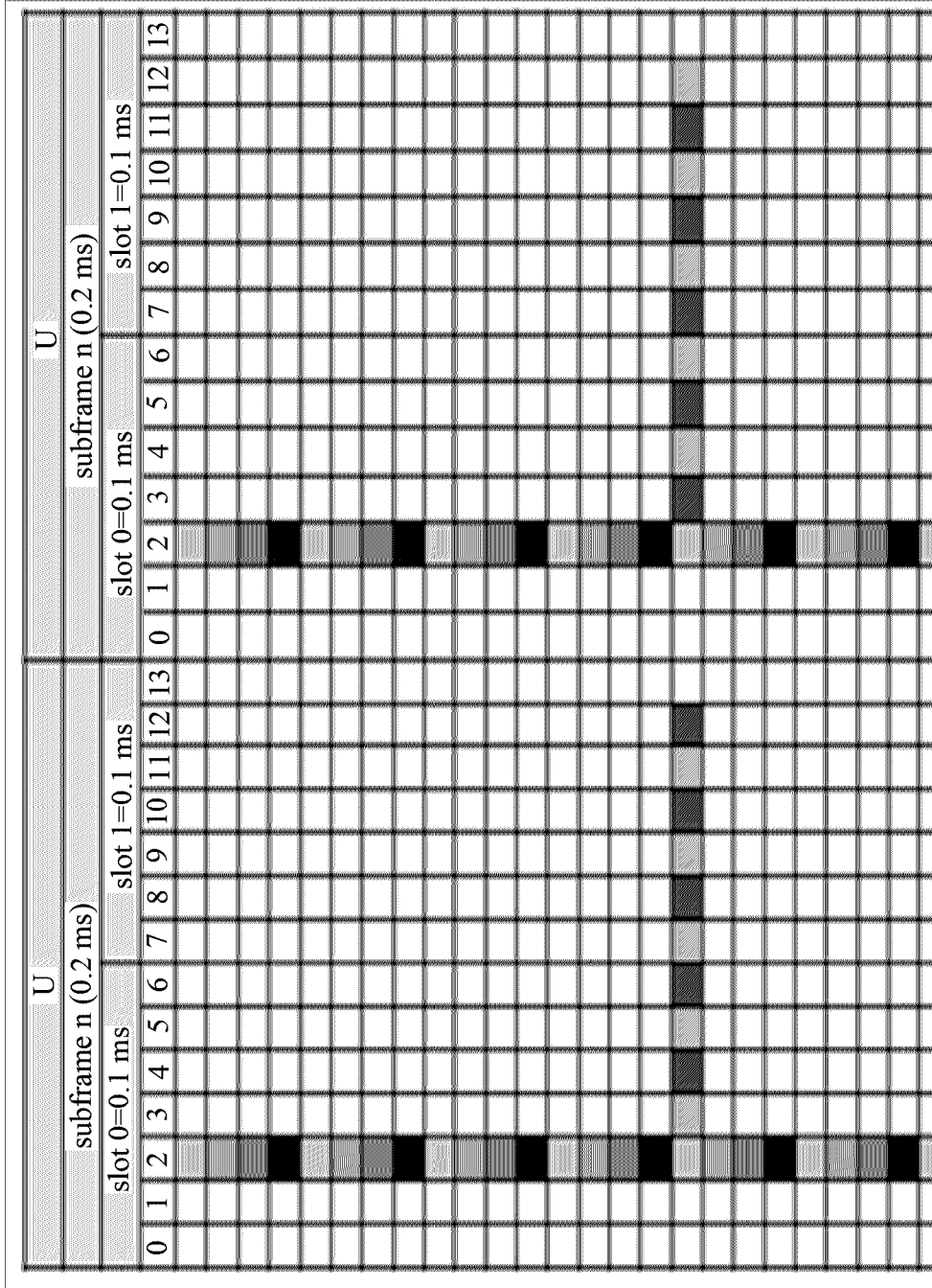

FIG. 1C (PRIOR ART)



TO
FIG. 2A-2

FIG. 2A-1 (PRIOR ART)

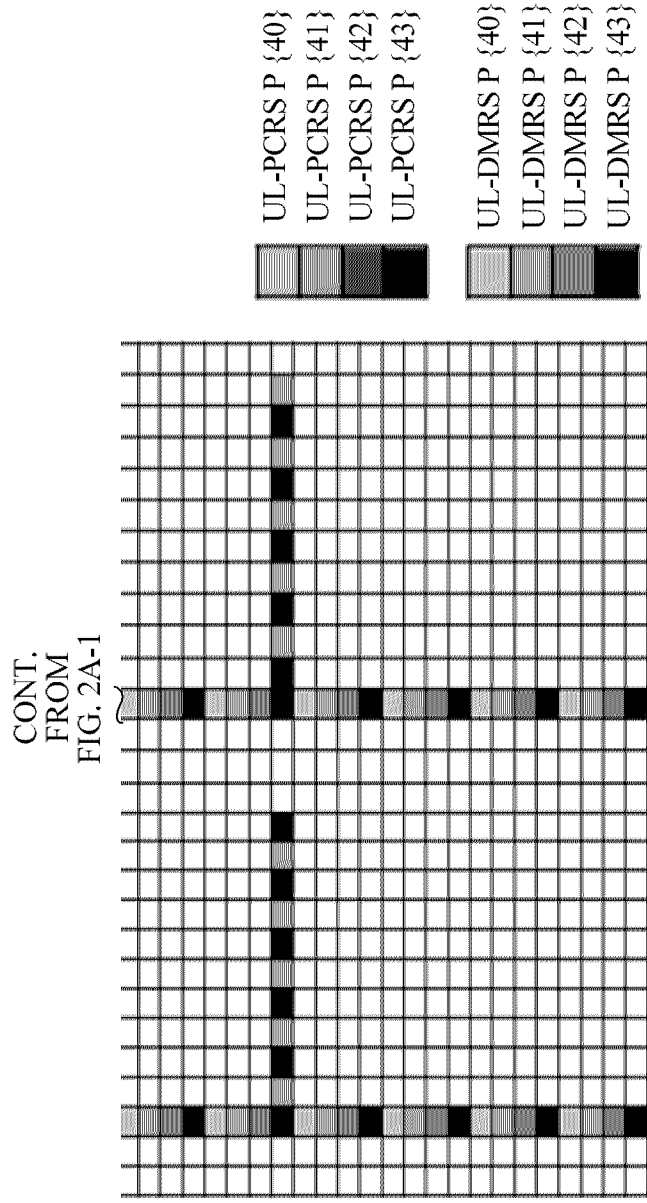
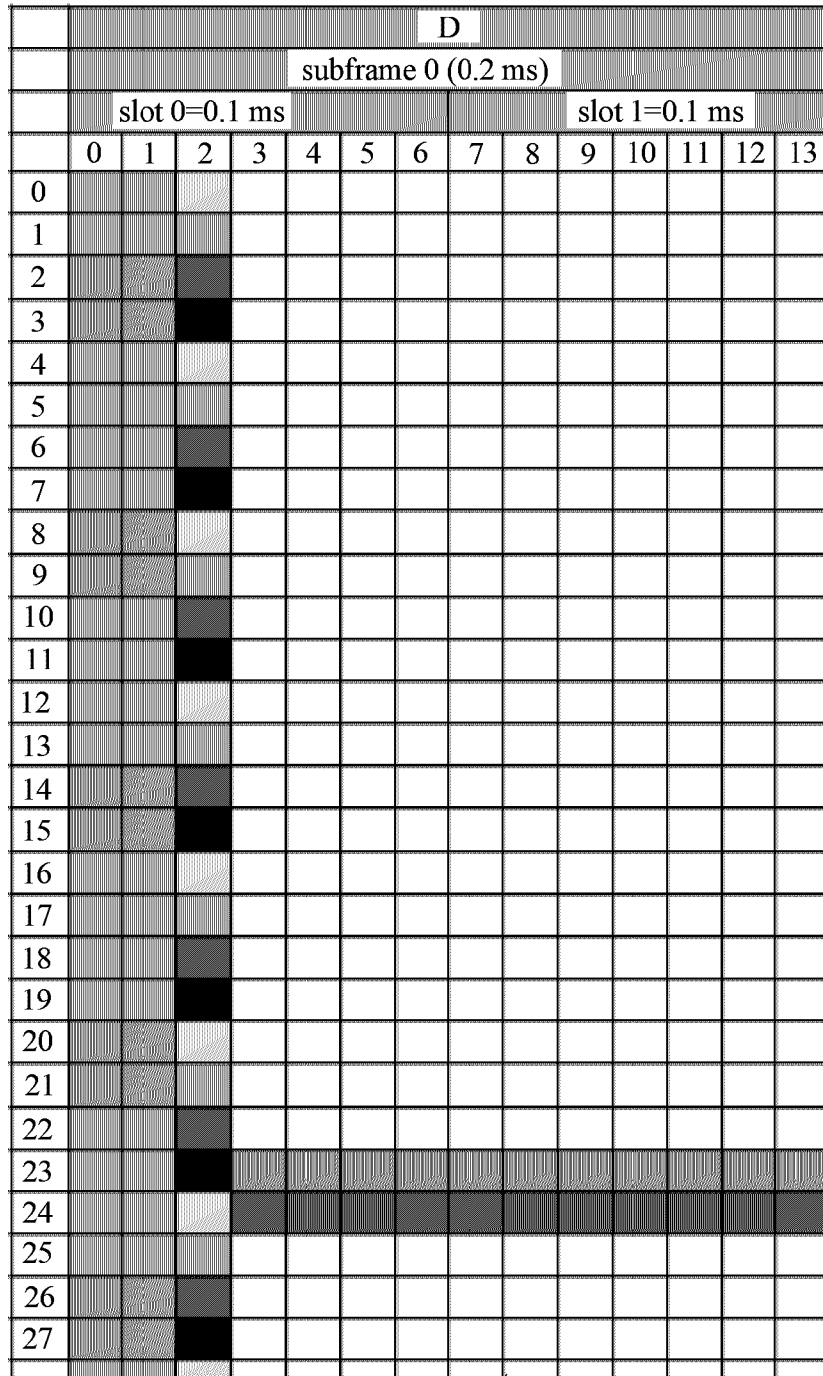

FIG. 2A-2 (PRIOR ART)



TO
FIG. 2B-2

FIG. 2B-1 (PRIOR ART)

CONT.
FROM
FIG. 2B-1

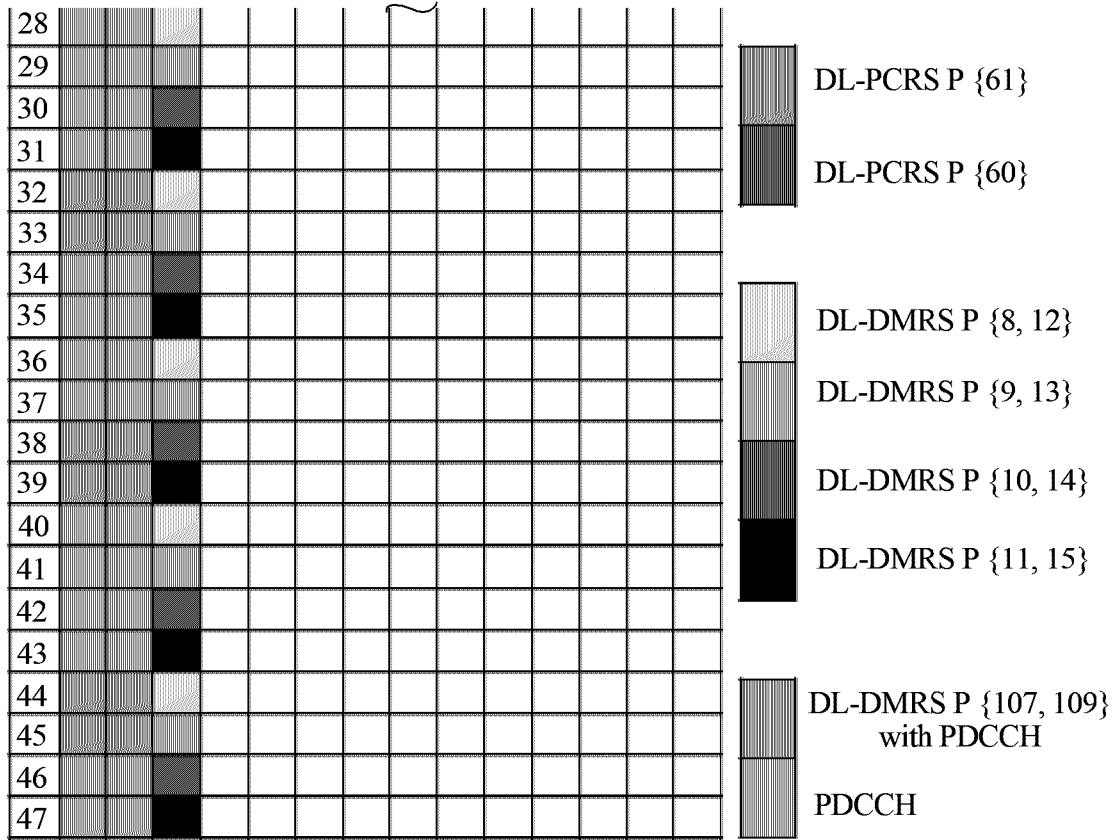

FIG. 2B-2 (PRIOR ART)

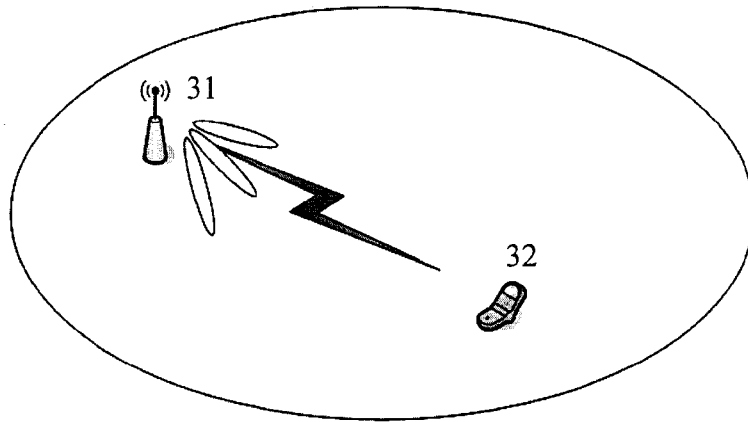

FIG. 3

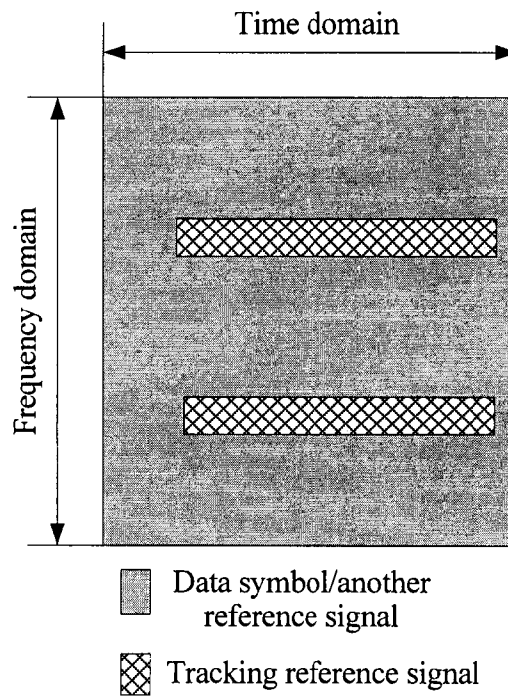

FIG. 4

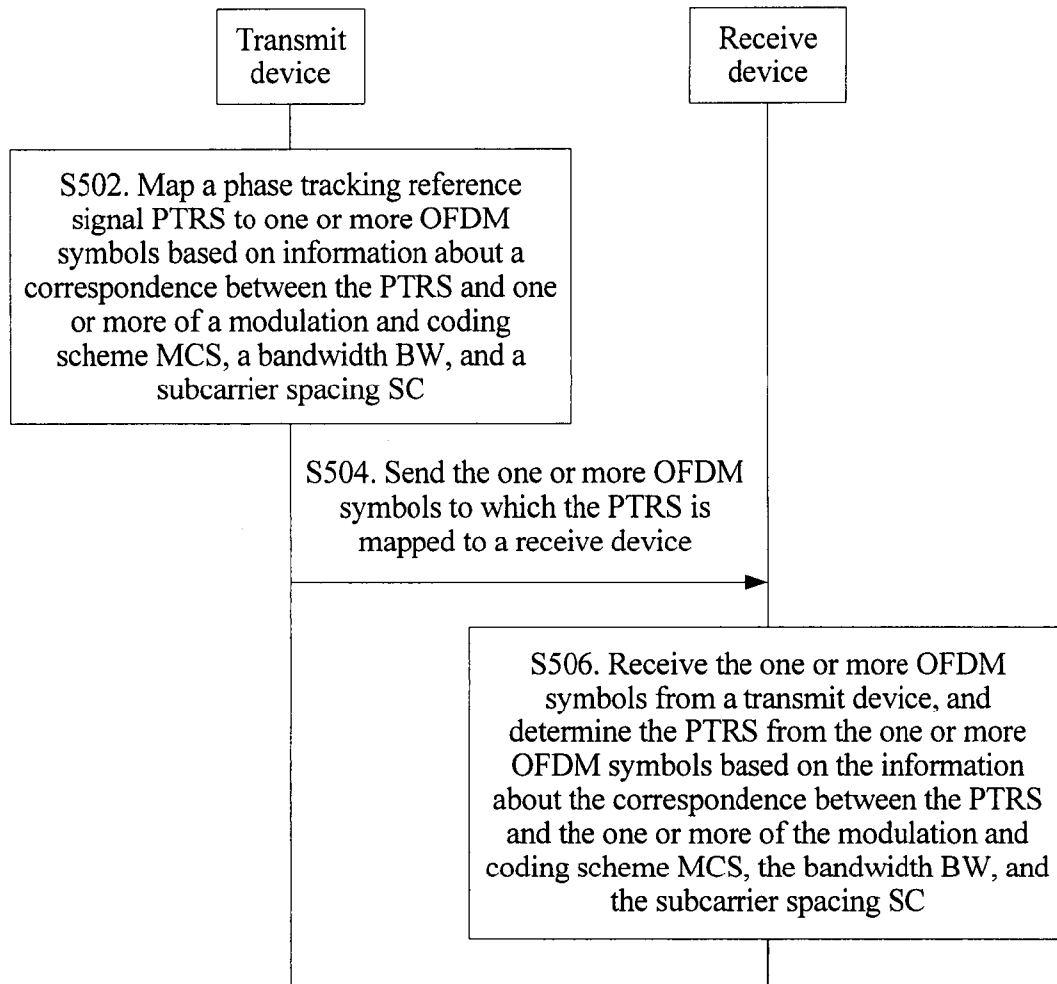

FIG. 5

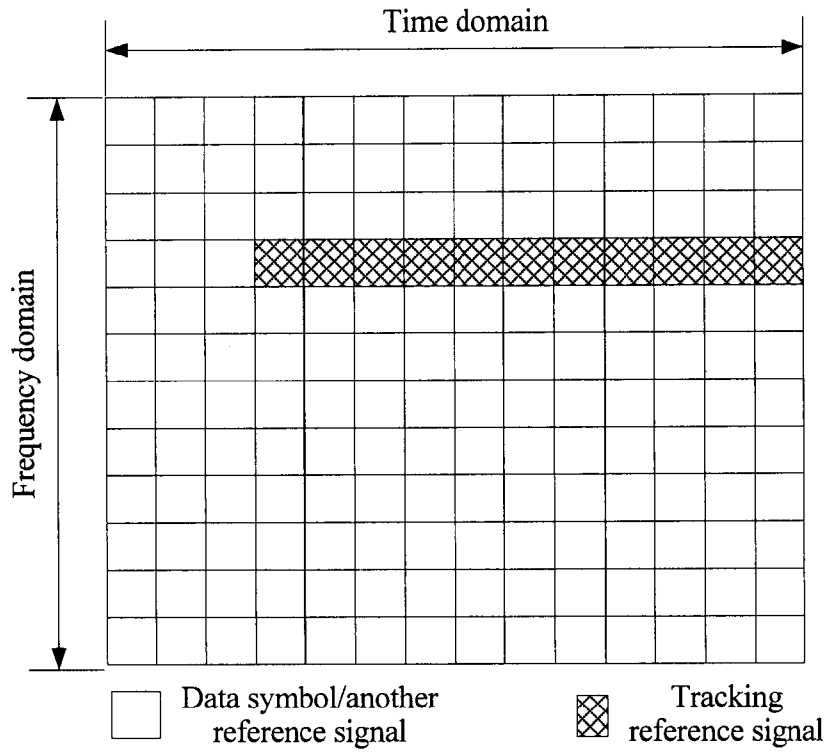

FIG. 6A

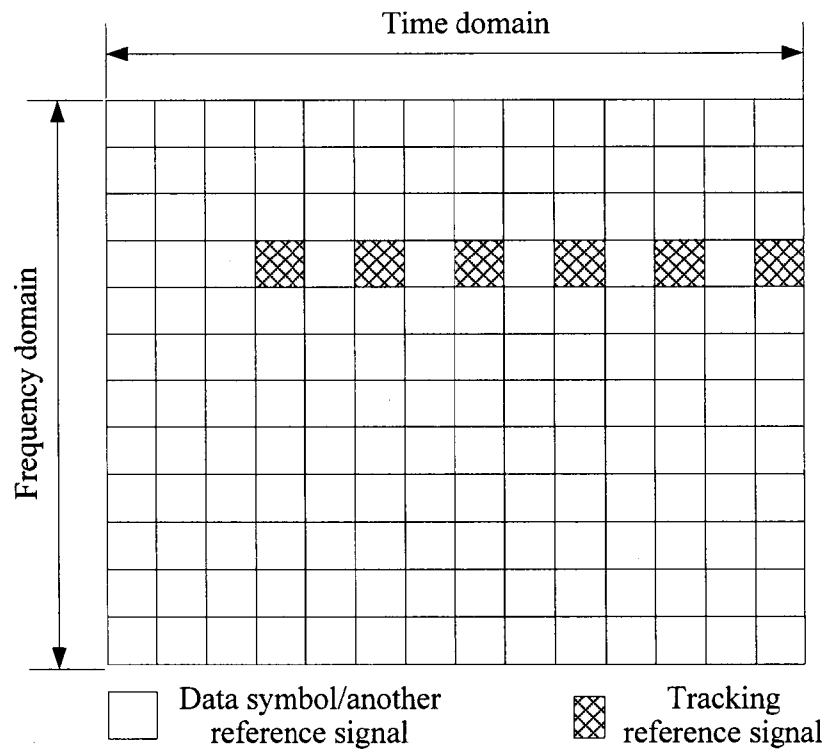

FIG. 6B

11/14

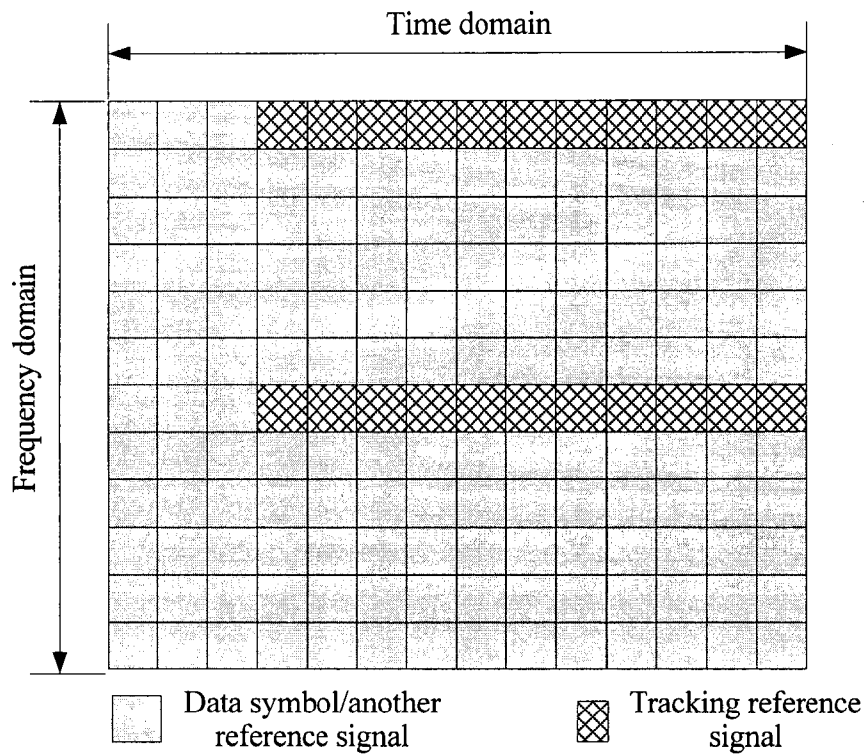

FIG. 7A

12/14

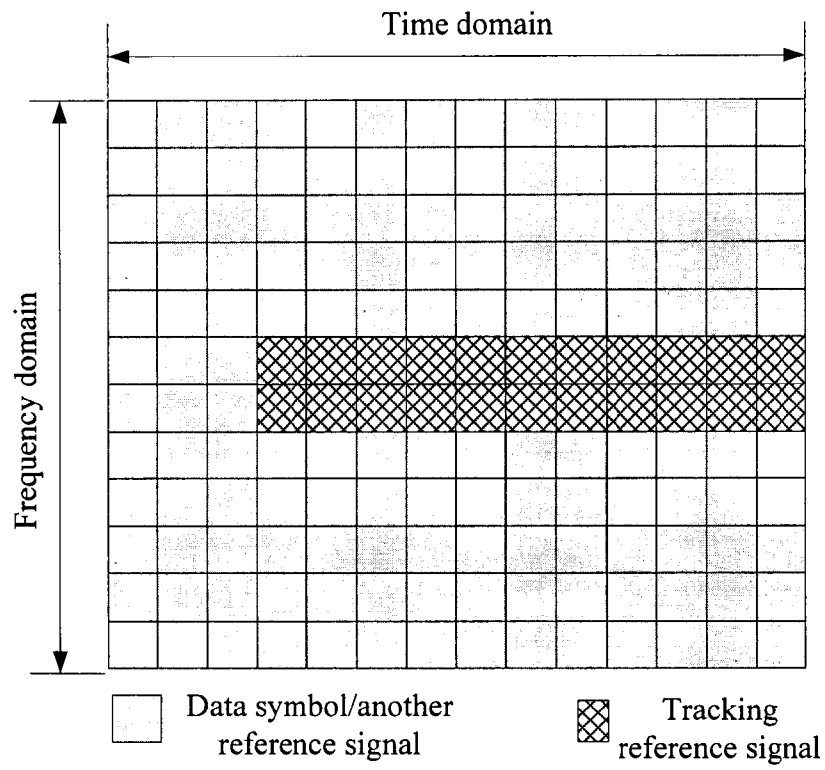

FIG. 7B

13/14

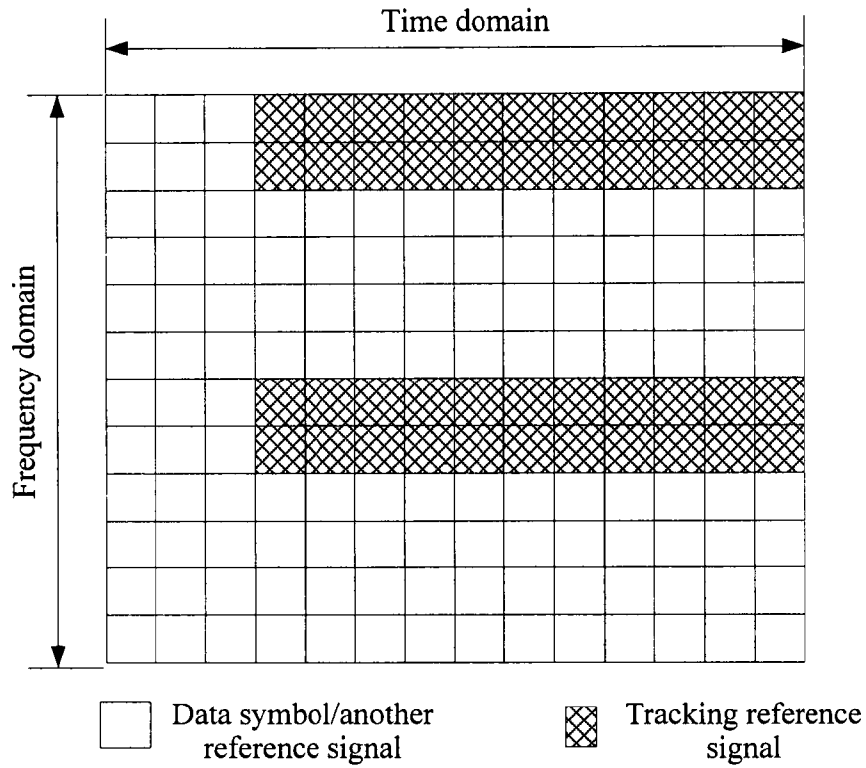

FIG. 7C

800

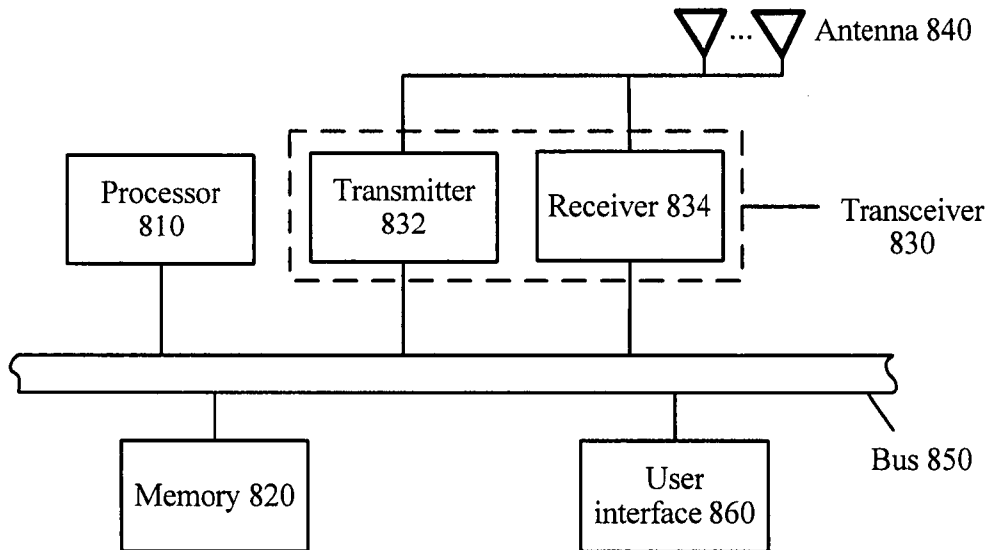

FIG. 8

900

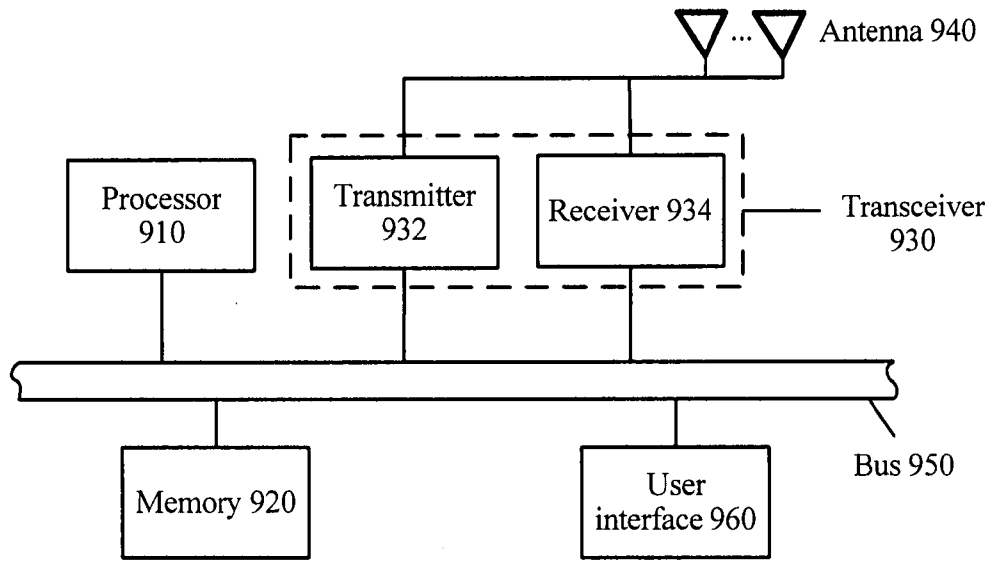

FIG. 9

Transmit device

Receive device

S502. Map a phase tracking reference signal PTRS to one or more OFDM symbols based on information about a correspondence between the PTRS and one or more of a modulation and coding scheme MCS, a bandwidth BW, and a subcarrier spacing SC

S504. Send the one or more OFDM symbols to which the PTRS is mapped to a receive device

S506. Receive the one or more OFDM symbols from a transmit device, and determine the PTRS from the one or more OFDM symbols based on the information about the correspondence between the PTRS and the one or more of the modulation and coding scheme MCS, the bandwidth BW, and the subcarrier spacing SC