



US00D727283S

(12) **United States Design Patent**
Dryden et al.

(10) **Patent No.:** **US D727,283 S**

(45) **Date of Patent:** **** Apr. 21, 2015**

(54) **FABRIC PATTERN FOR HEADPHONE
SCRIMS**

(71) Applicant: **Bose Corporation**, Framingham, MA
(US)

(72) Inventors: **Joshua Kevin Dryden**, Marlborough,
MA (US); **Adam A. Carr**,
Southborough, MA (US); **Kevin M.
Krauss**, Sudbury, MA (US); **Nathan
David Schaal**, Cambridge, MA (US);
Mitchell Joseph Silva, Groton, MA
(US)

(73) Assignee: **Bose Corporation**, Framingham, MA
(US)

(**) Term: **14 Years**

(21) Appl. No.: **29/482,028**

(22) Filed: **Feb. 13, 2014**

(51) **LOC (10) Cl.** **14-01**

(52) **U.S. Cl.**

USPC **D14/205**

(58) **Field of Classification Search**

CPC H04R 25/00

USPC D14/204, 205, 210, 214, 215, 216, 217,
D14/221; 181/129, 130, 199, 210, 284;
379/430, 431; 381/380, 381; 455/90.3,
455/575.1; D21/334, 343, 344, 348;
D26/138, 139, 154; 359/485.06,
359/485.02; 396/150, 200; 362/217.1, 19,
362/225; D25/126; 356/221

See application file for complete search history.

(56) **References Cited**

U.S. PATENT DOCUMENTS

D28,317	S	*	2/1898	Rachleff	D21/348
598,969	A	*	2/1898	Anderton	273/261
943,435	A	*	12/1909	Maris	273/288
971,369	A	*	9/1910	Genest et al.	428/45
1,241,886	A	*	10/1917	Rowe	362/339

1,373,448	A	*	4/1921	Precinauskas	273/261
1,610,423	A	*	12/1926	Cawley	353/20
1,623,881	A	*	4/1927	Mayer	273/264
D73,030	S	*	7/1927	Gosling	D14/215
2,707,228	A	*	4/1955	Philipson	362/208
D182,794	S	*	5/1958	Eames	D14/214
3,294,964	A	*	12/1966	Schwartz	362/19
D211,592	S	*	7/1968	Schultz	D21/334
D224,548	S	*	8/1972	Tyler et al.	D21/348
D228,389	S	*	9/1973	Schneider	D14/214
D231,746	S	*	6/1974	Aluppa	D21/348
D233,055	S	*	10/1974	Keller	D21/362
4,339,136	A	*	7/1982	Gittings	273/242

(Continued)

Primary Examiner — Paula Greene

(57) **CLAIM**

The ornamental design for a fabric pattern for headphone
scrims, substantially as shown and described.

DESCRIPTION

FIG. 1 is a perspective view of a first set of headphones
bearing a fabric pattern on the headphone scrim as seen from
the front, top, and right side;

FIG. 2 is front view thereof;

FIG. 3 is a back view thereof;

FIG. 4 is a left side view thereof;

FIG. 5 is a right side view thereof;

FIG. 6 is a top end view thereof;

FIG. 7 is a bottom end view thereof.

FIG. 8 is a perspective view of a second set of headphones
bearing the fabric pattern on the headphone scrim as seen
from the front, top, and right side;

FIG. 9 is right side view thereof;

FIG. 10 is a front view thereof;

FIG. 11 is a left side view thereof;

FIG. 12 is a back view thereof;

FIG. 13 is a top end view thereof; and,

FIG. 14 is a bottom end view thereof.

The dotted line portions of the drawings represent environ-
mental structure only and do not form part of the claimed
design.

1 Claim, 11 Drawing Sheets

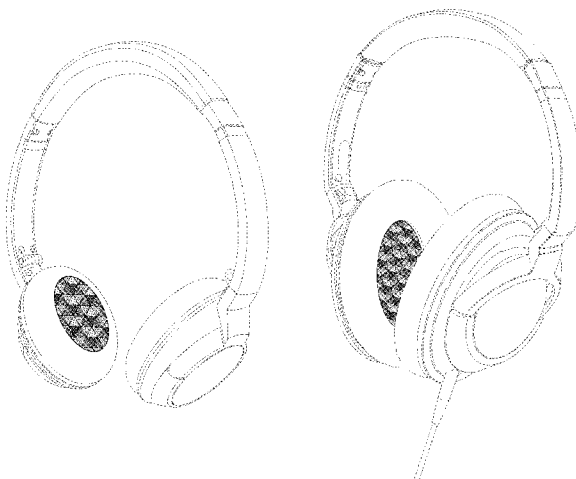

(56)

References Cited

U.S. PATENT DOCUMENTS

D298,342	S	*	11/1988	Haddad	D21/348	6,935,458	B2	*	8/2005	Owens	181/205
5,014,995	A	*	5/1991	Woodward	273/261	D642,554	S		8/2011	Schaal et al.		
5,086,789	A	*	2/1992	Tichy	128/866	D662,080	S		6/2012	Carr et al.		
D384,195	S	*	9/1997	Brooks et al.	D2/970	D678,244	S	*	3/2013	Behar et al.	D14/214
							D688,414	S	*	8/2013	Gut	D26/154
							D695,710	S	*	12/2013	Szymanski et al.	D14/214

* cited by examiner

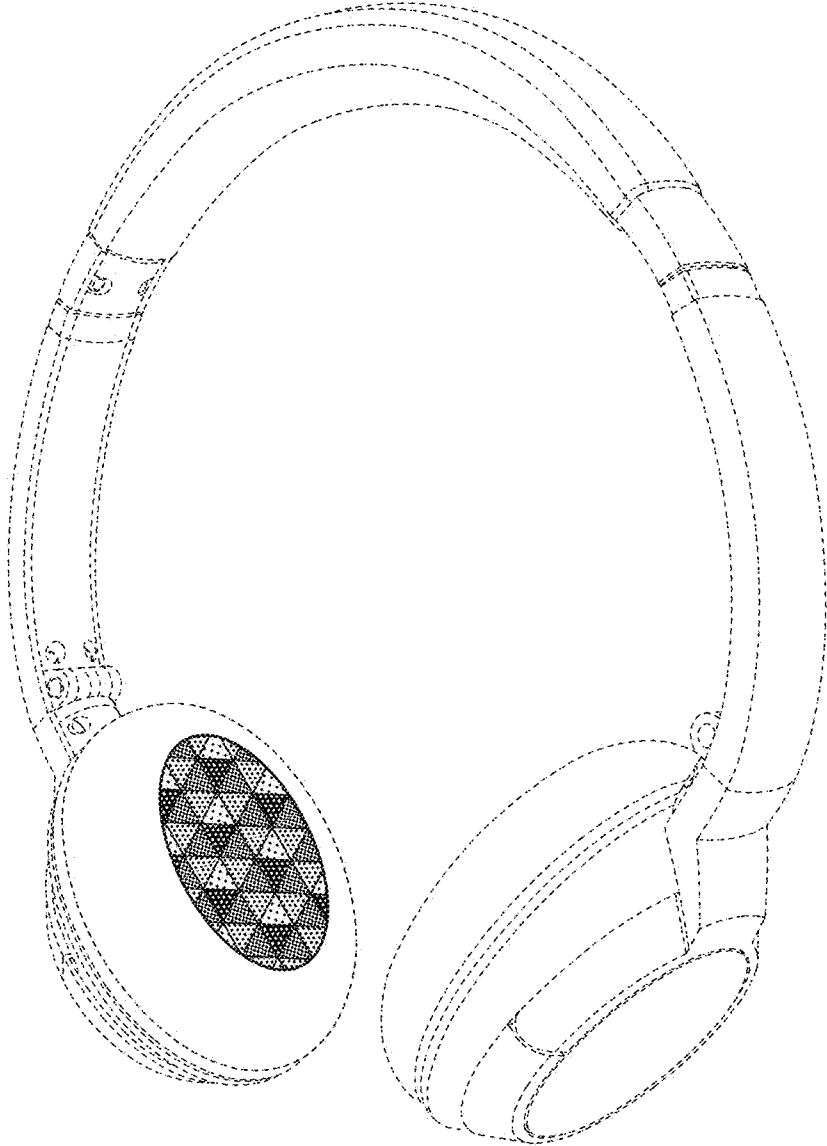

FIG. 1

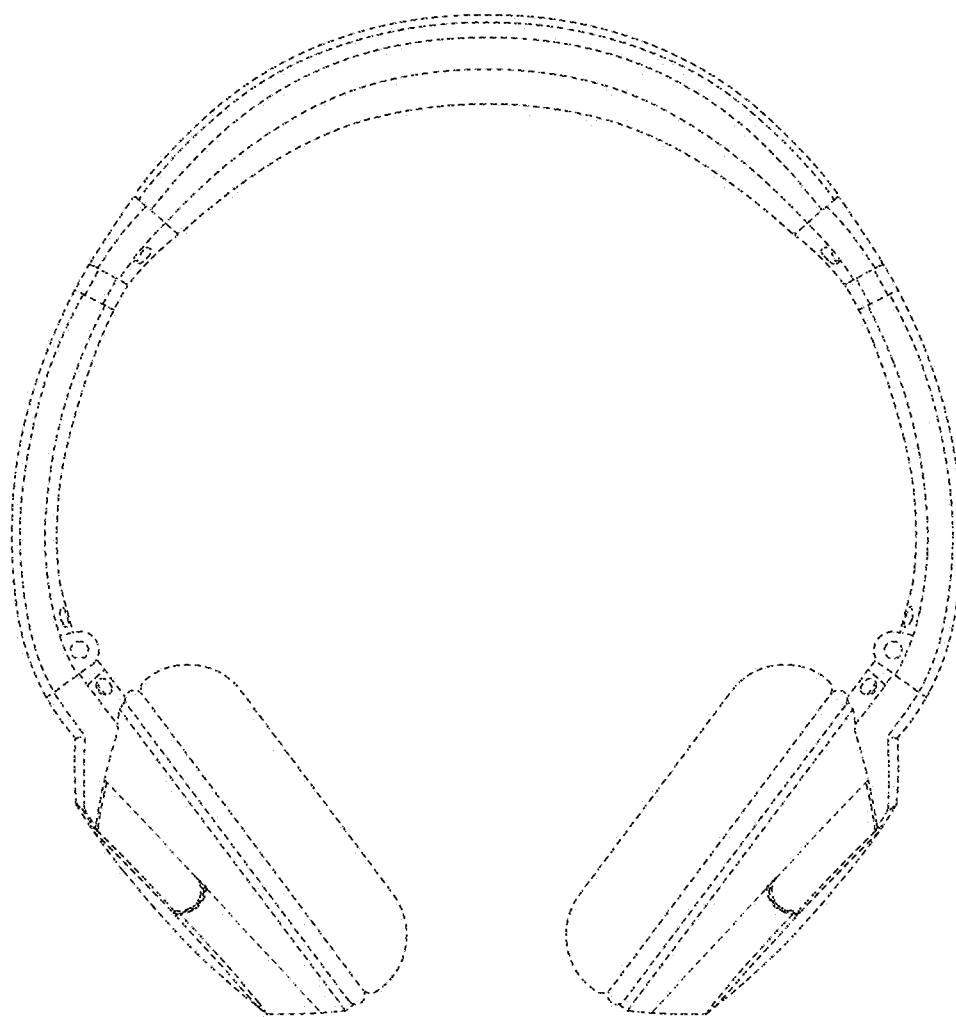

FIG. 2

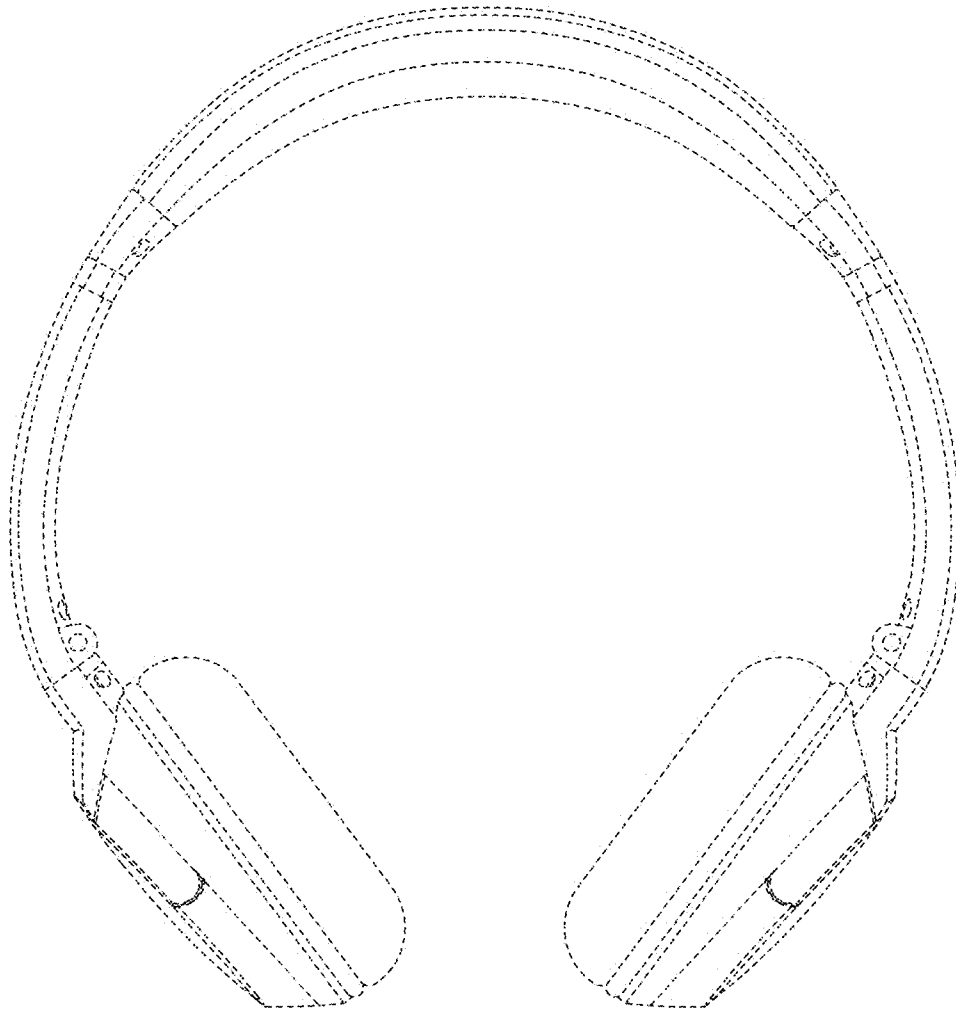

FIG. 3

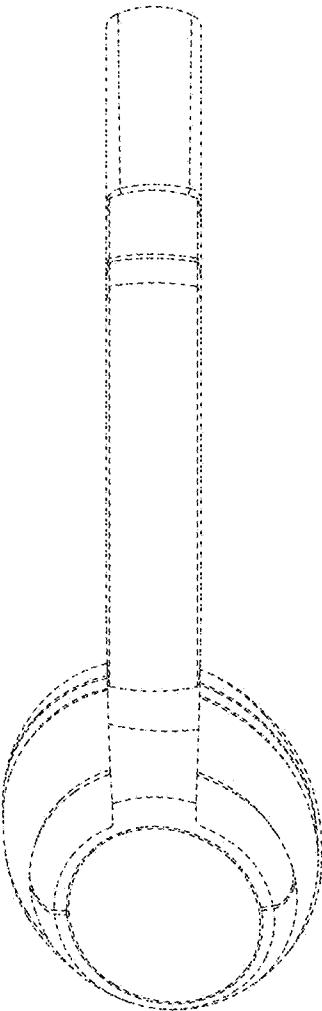

FIG. 4

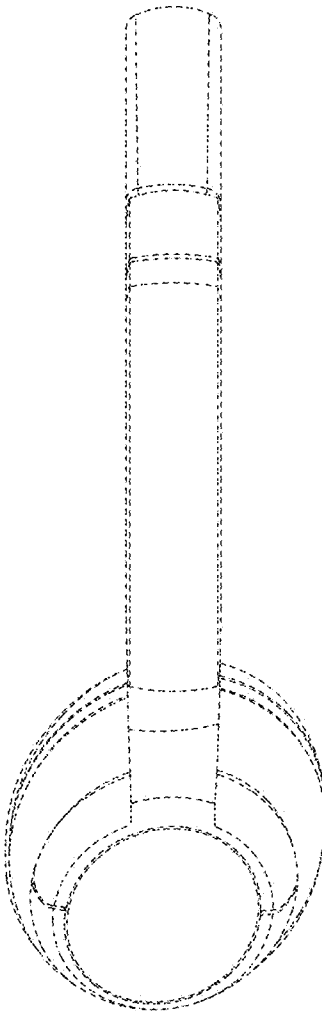

FIG. 5

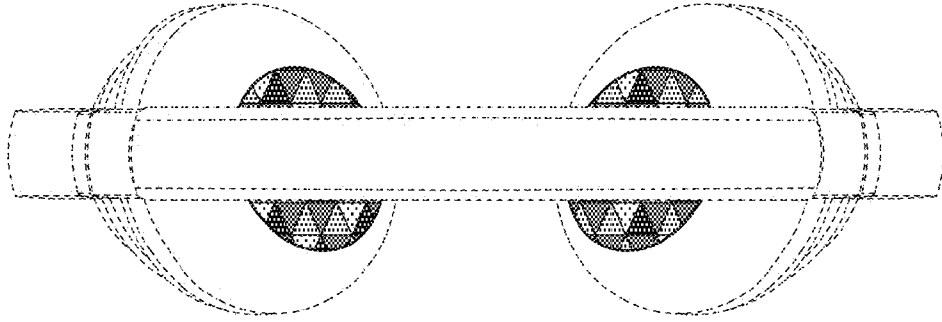

FIG. 6

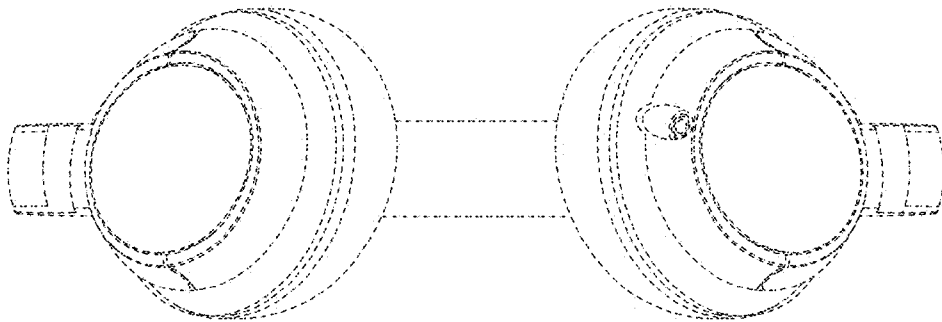

FIG. 7

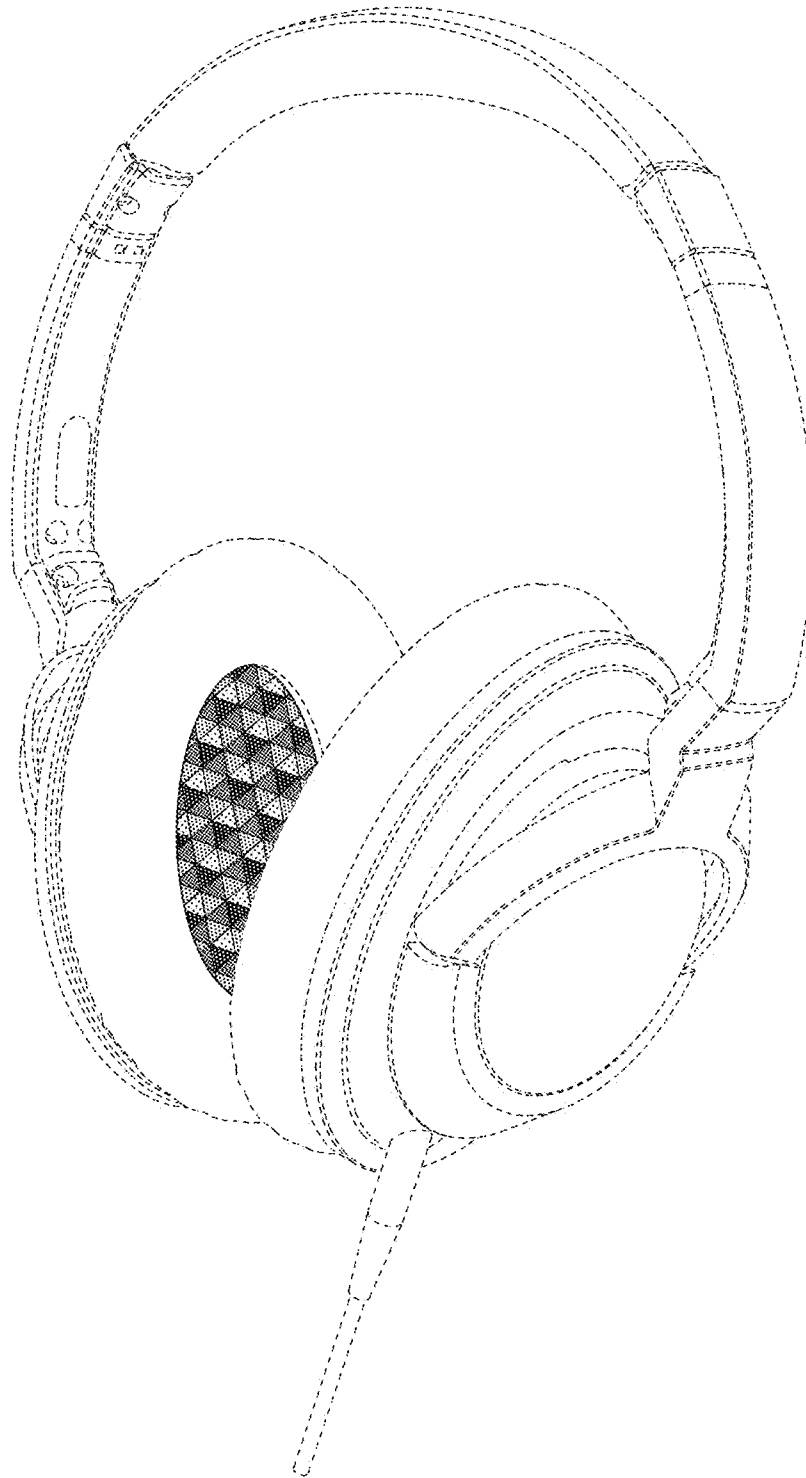

FIG. 8

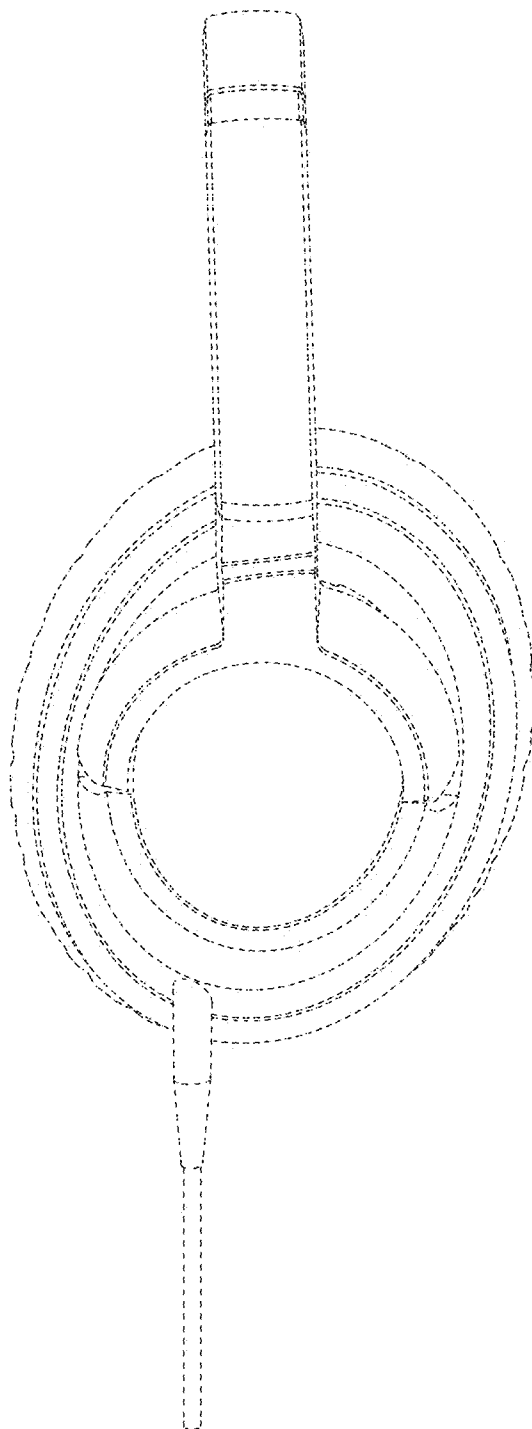

FIG. 9

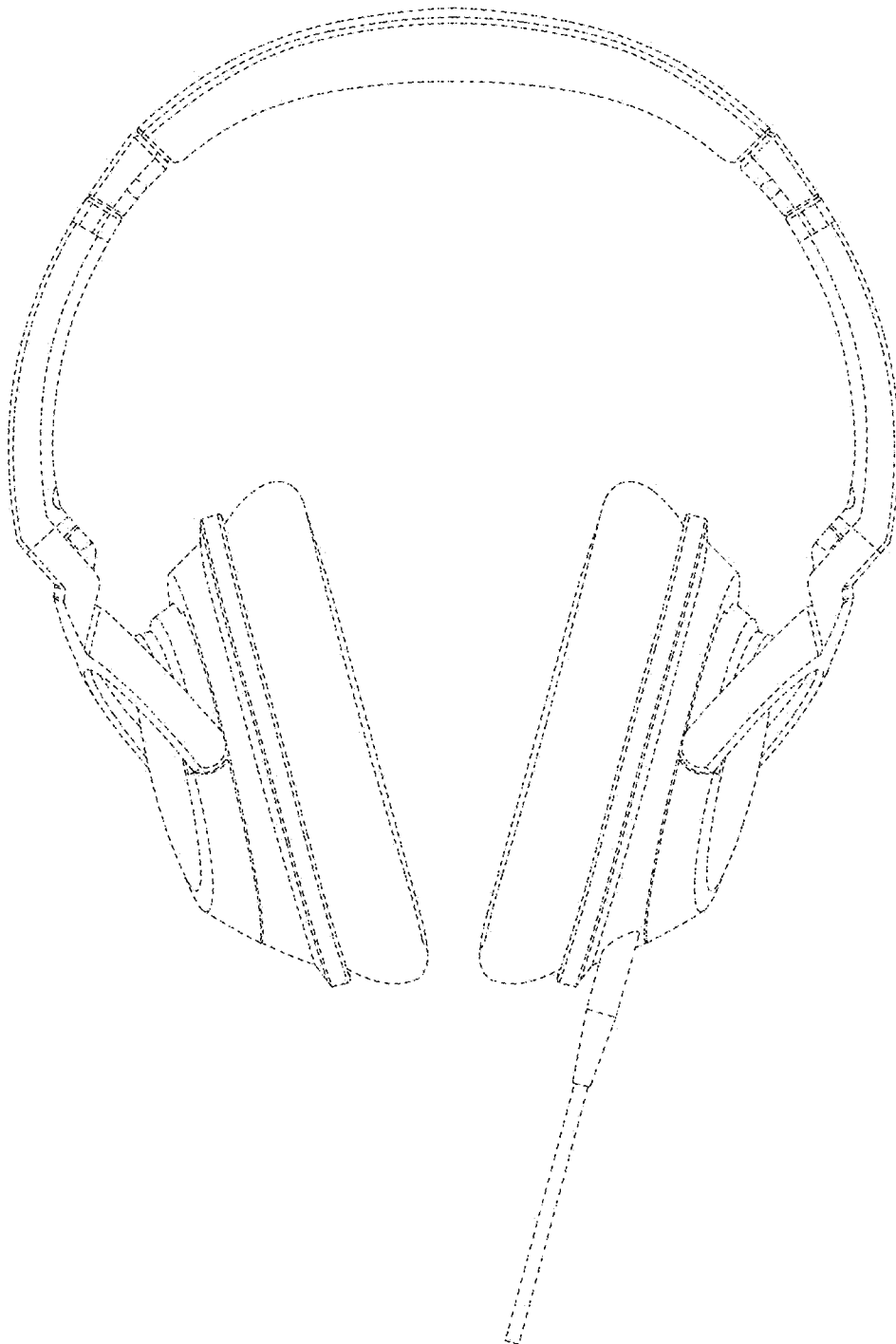

FIG. 10

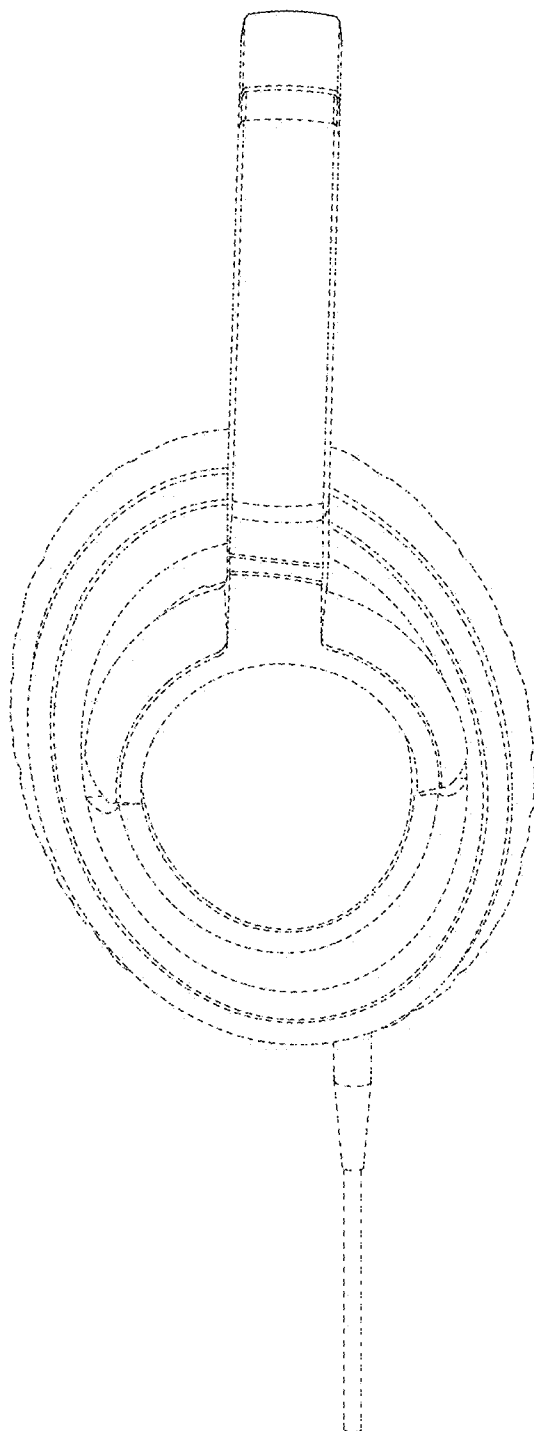

FIG. 11



FIG. 12

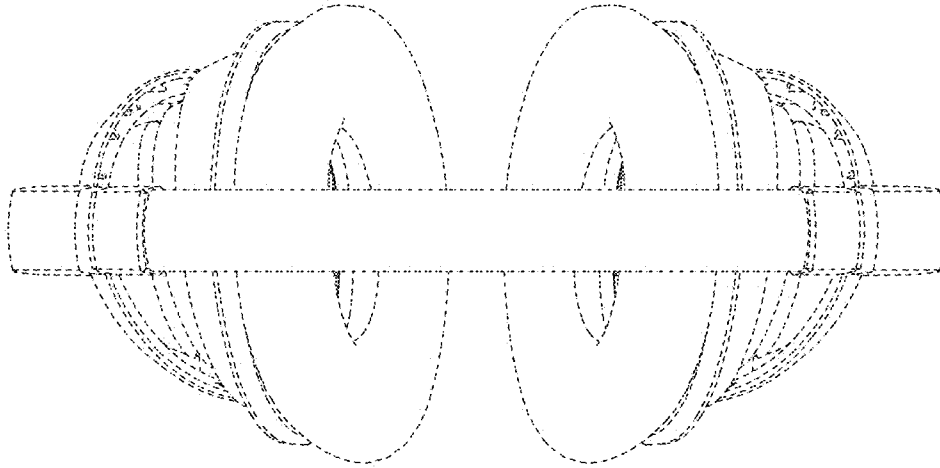

FIG. 13

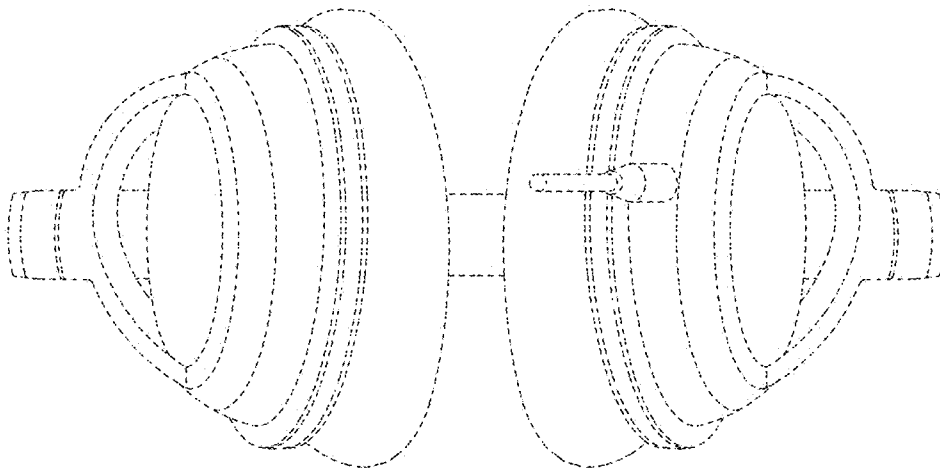

FIG. 14