



US00D469413S

(12) **United States Design Patent** (10) **Patent No.:** **US D469,413 S**  
**To et al.** (45) **Date of Patent:** **\*\* Jan. 28, 2003**

- (54) **HEADREST OR SEAT BACK ENTERTAINMENT DISPLAY**
- (75) Inventors: **Nguyen To**, Vista, CA (US); **Mark Rutledge**, Murrieta, CA (US); **Charlie Quong**, Irvine, CA (US)
- (73) Assignee: **Directed Electronics, Inc.**, Vista, CA (US)
- (\*\*) Term: **14 Years**
- (21) Appl. No.: **29/153,417**
- (22) Filed: **Jan. 5, 2002**
- (51) **LOC (7) Cl.** ..... **14-03**
- (52) **U.S. Cl.** ..... **D14/126**
- (58) **Field of Search** ..... D14/125-136, D14/239, 371, 315, 336-355, 374-401, 496, 156; D21/329; 312/7.2; 348/825, 836, 838; 345/348, 133, 139, 905, 967, 976, 977; 248/917; 341/12; 340/700

(56) **References Cited**

**U.S. PATENT DOCUMENTS**

D324,040 S	*	2/1992	Saito et al.	.....	D14/126
5,100,098 A	*	3/1992	Hawkins	.....	248/917
5,173,686 A	*	12/1992	Fujihara	.....	340/700
D376,588 S	*	12/1996	Shinano	.....	D14/126
D405,781 S	*	2/1999	Renk	.....	D21/329
D415,147 S	*	10/1999	Adachi	.....	D14/126
6,020,867 A	*	1/2000	Shimada et al.	.....	345/905
D422,575 S	*	4/2000	Tikhonski et al.	.....	D14/126
D438,849 S	*	3/2001	Adachi et al.	.....	D14/132
D439,567 S	*	3/2001	Forlenza et al.	.....	D14/129
D446,193 S	*	8/2001	Lavelle et al.	.....	D14/126

\* cited by examiner

*Primary Examiner*—Raphael Barkai  
(74) *Attorney, Agent, or Firm*—KC Bean

(57) **CLAIM**

The ornamental design of a headrest or seat back entertainment display, as shown and described.

**DESCRIPTION**

FIG. 1 is the front view of the headrest or seat back entertainment display of our new design;

FIG. 2 is the back view of the headrest or seat back entertainment display of our new design;

FIG. 3 is the top side view of the headrest or seat back entertainment display of our new design;

FIG. 4 is the bottom side view of the headrest or seat back entertainment display of our new design;

FIG. 5 is the right side view of the headrest or seat back entertainment display of our new design;

FIG. 6 is the left side view of the headrest or seat back entertainment display of our new design;

FIG. 7 is the trimetric view of the headrest or seat back entertainment display of our new design;

FIG. 8 is an expanded detailed view of the front view of the headrest or seat back entertainment display of our new design;

FIG. 9 is an expanded detailed view of the back view of the headrest or seat back entertainment display of our new design;

FIG. 10 is an expanded detailed view of the top side view of the headrest or seat back entertainment display of our new design;

FIG. 11 is an expanded detailed view of the bottom side view of the headrest or seat back entertainment display of our new design;

FIG. 12 is an expanded detailed view of the right side view of the headrest or seat back entertainment display of our new design;

FIG. 13 is an expanded detailed view of the left side view of the headrest or seat back entertainment display of our new design;

FIG. 14 is an expanded detailed view of the trimetric view of the headrest or seat back entertainment display of our new design;

FIG. 15 is a detailed view of the trimetric view of the headrest or seat back entertainment display of our new design with the display screen rotated out at the bottom; and,

FIG. 16 is a detailed view of the trimetric view of the headrest or seat back entertainment display of our new design with the display screen rotated out at the top.

**1 Claim, 9 Drawing Sheets**

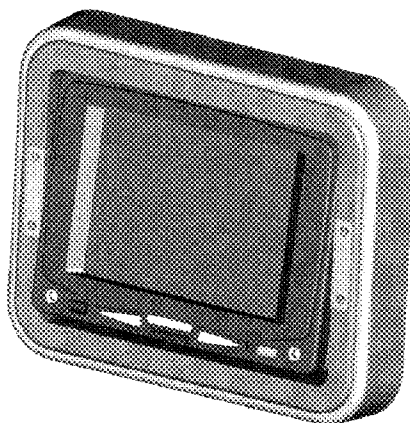

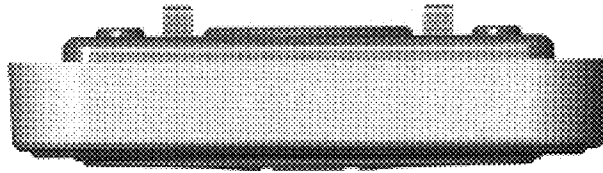

FIGURE 3

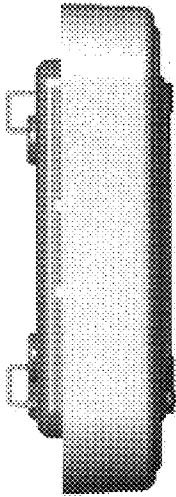

FIGURE 6

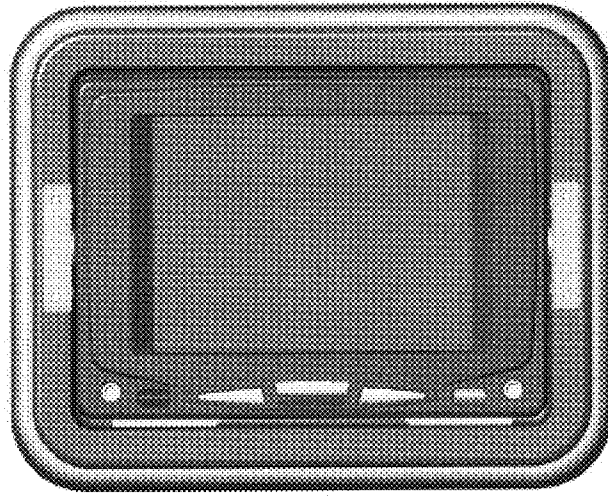

FIGURE 1

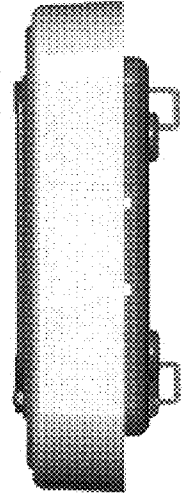

FIGURE 5

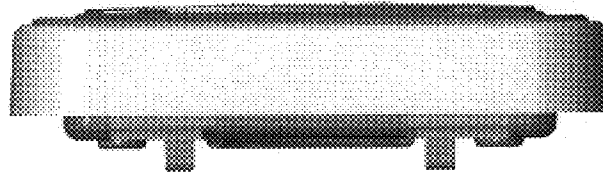

FIGURE 4

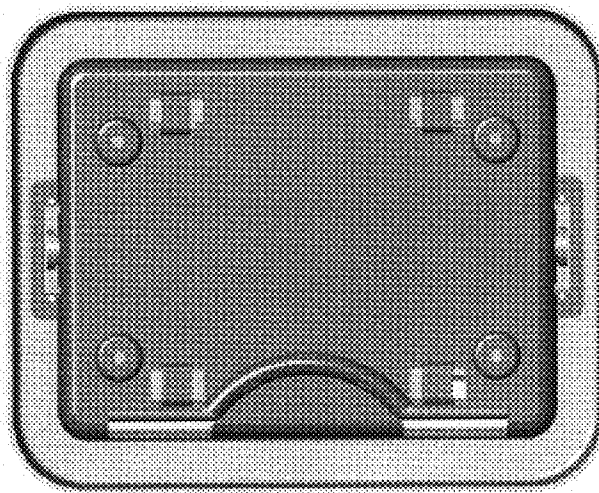

FIGURE 2

**FIGURE 7**

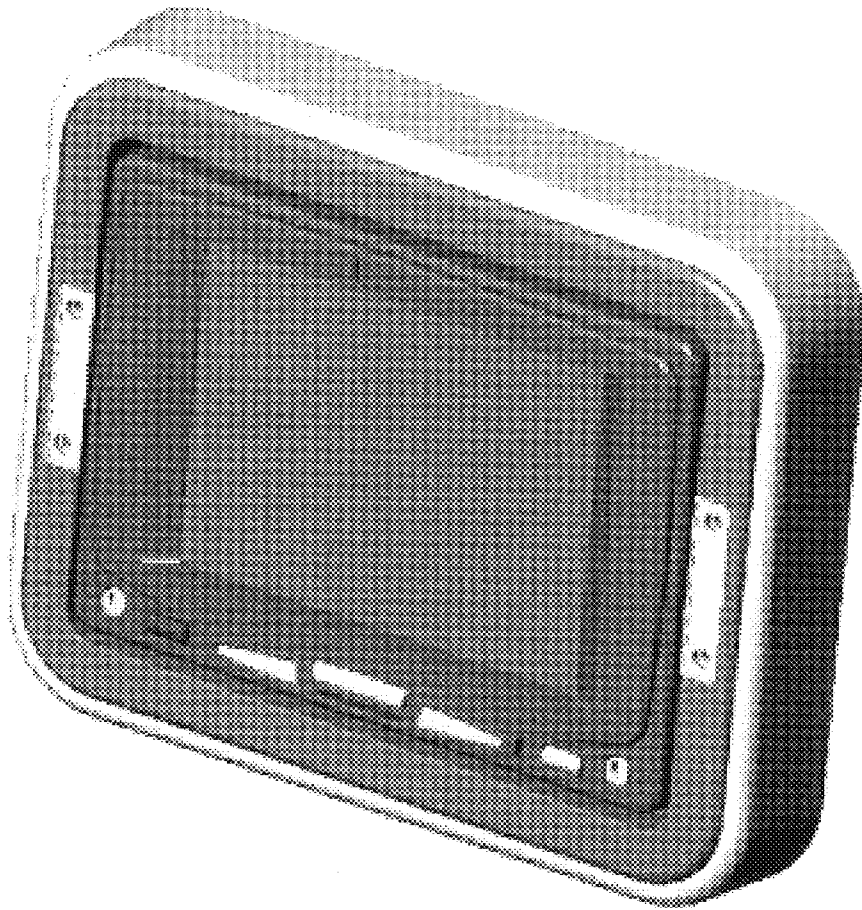

FIGURE 8

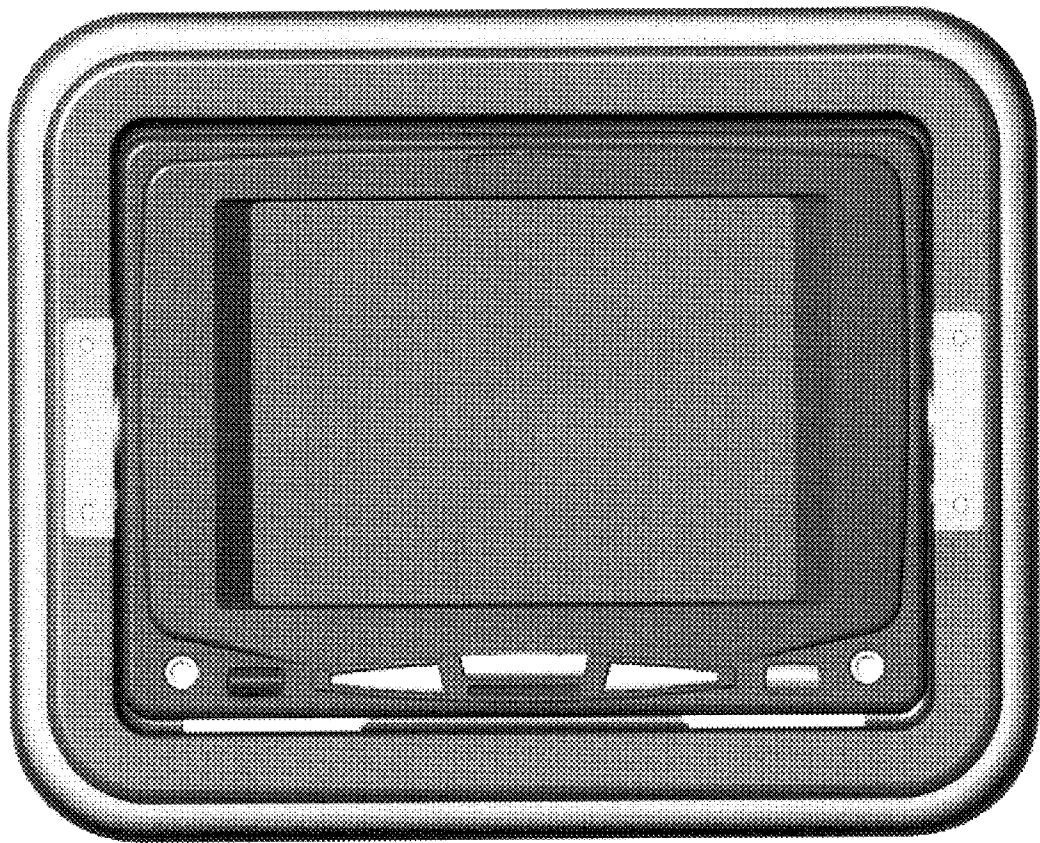

FIGURE 9

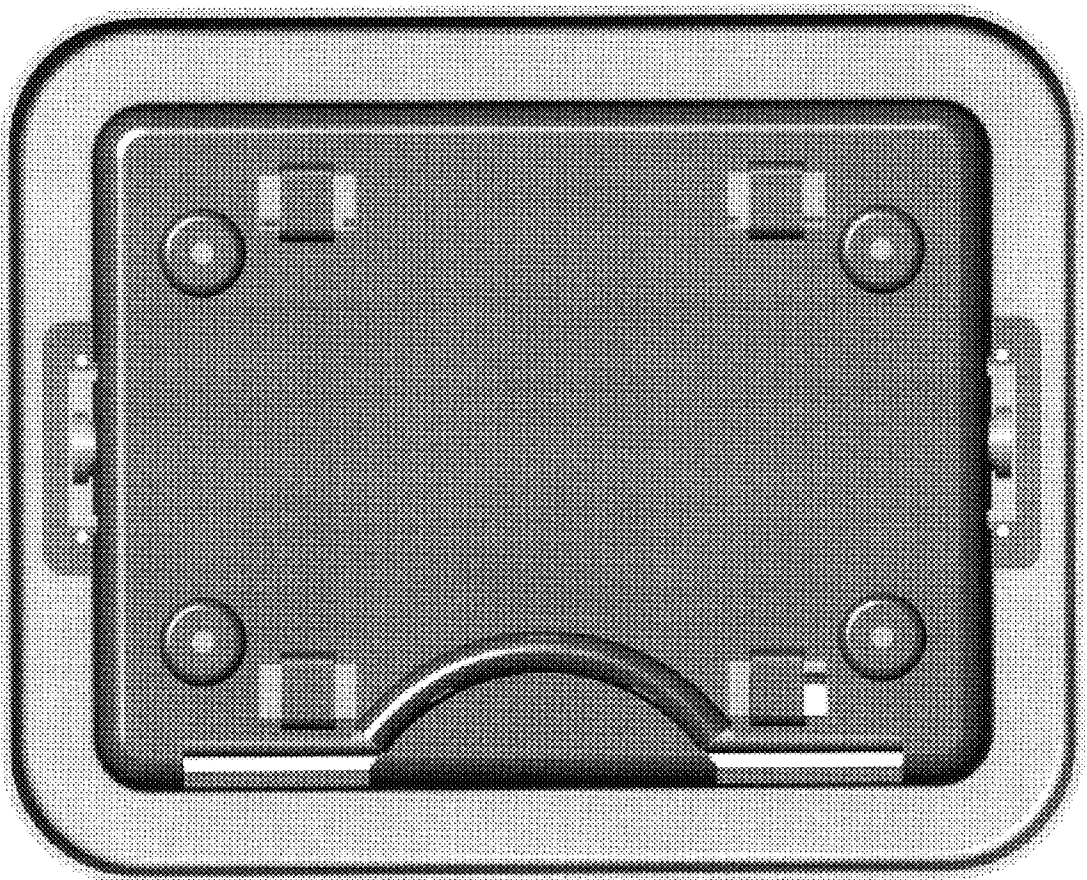

FIGURE 10

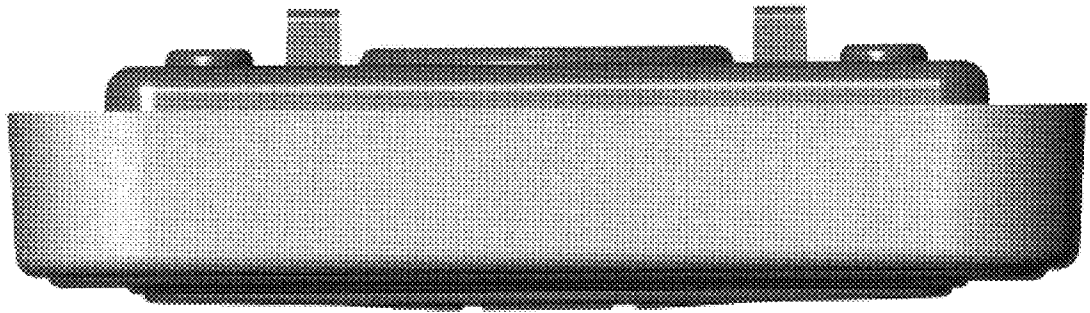

FIGURE 11

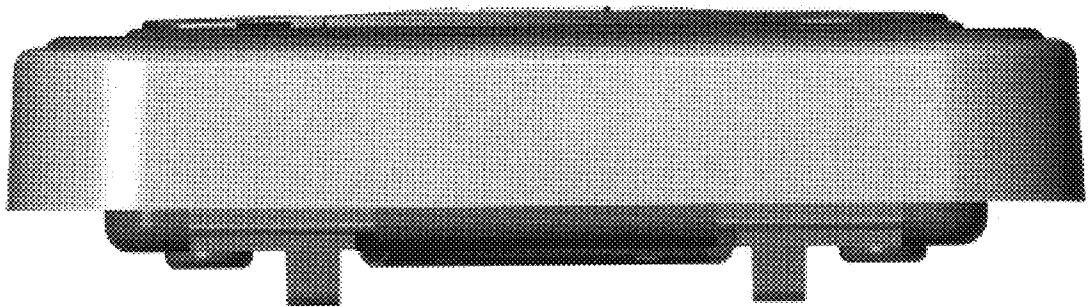

FIGURE 12

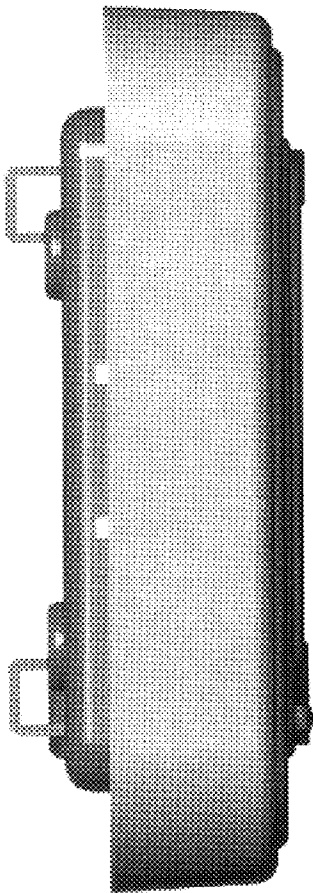

FIGURE 13

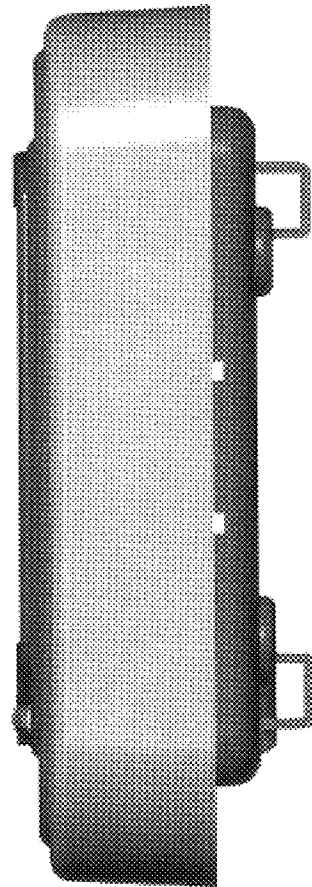



FIGURE 14





FIGURE 15



FIGURE 16

