



(22) Date de dépôt/Filing Date: 2001/05/21
 (41) Mise à la disp. pub./Open to Public Insp.: 2001/11/29
 (45) Date de délivrance/Issue Date: 2012/07/17
 (62) Demande originale/Original Application: 2 407 751
 (30) Priorités/Priorities: 2000/05/19 (US60/205,524);
 2000/05/24 (US60/206,628); 2001/03/02 (US60/273,234);
 2001/03/08 (US60/274,368)

(51) Cl.Int./Int.Cl. *A01N 57/20* (2006.01),
A01N 25/30 (2006.01), *A01P 13/00* (2006.01),
C07C 211/14 (2006.01), *C07C 215/14* (2006.01),
C07C 217/04 (2006.01)

(72) Inventeurs/Inventors:
 LENNON, PATRICK J., US;
 CHEN, XIANGYANG, US;
 ARHANCET, GRACIELA B., US;
 GLAENZER, JEANETTE L., US;
 GILLESPIE, JANE L., US;
 GRAHAM, JEFFREY A., US;

(73) Propriétaire/Owner:

(54) Titre : TENSIOACTIFS POUVANT ETRE UTILISES DANS DES FORMULATION DE GLYSOPHATE DE POTASSIUM

(54) Title: SURFACTANTS SUITABLE FOR USE IN POTASSIUM GLYPHOSATE FORMULATIONS

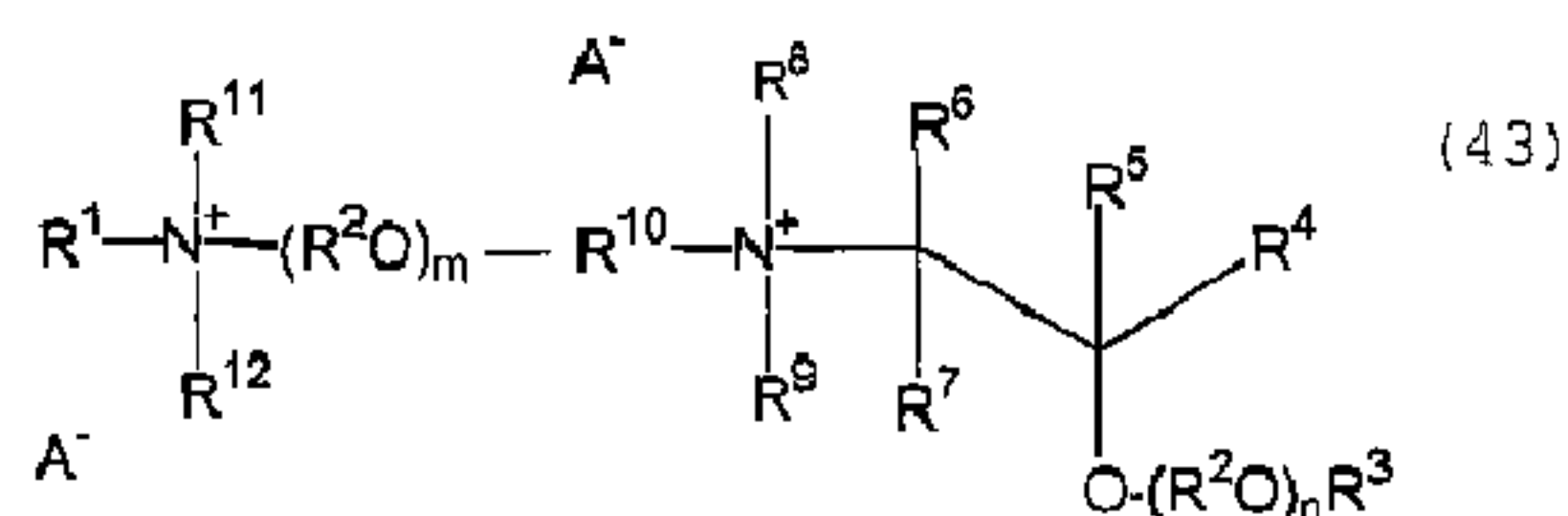
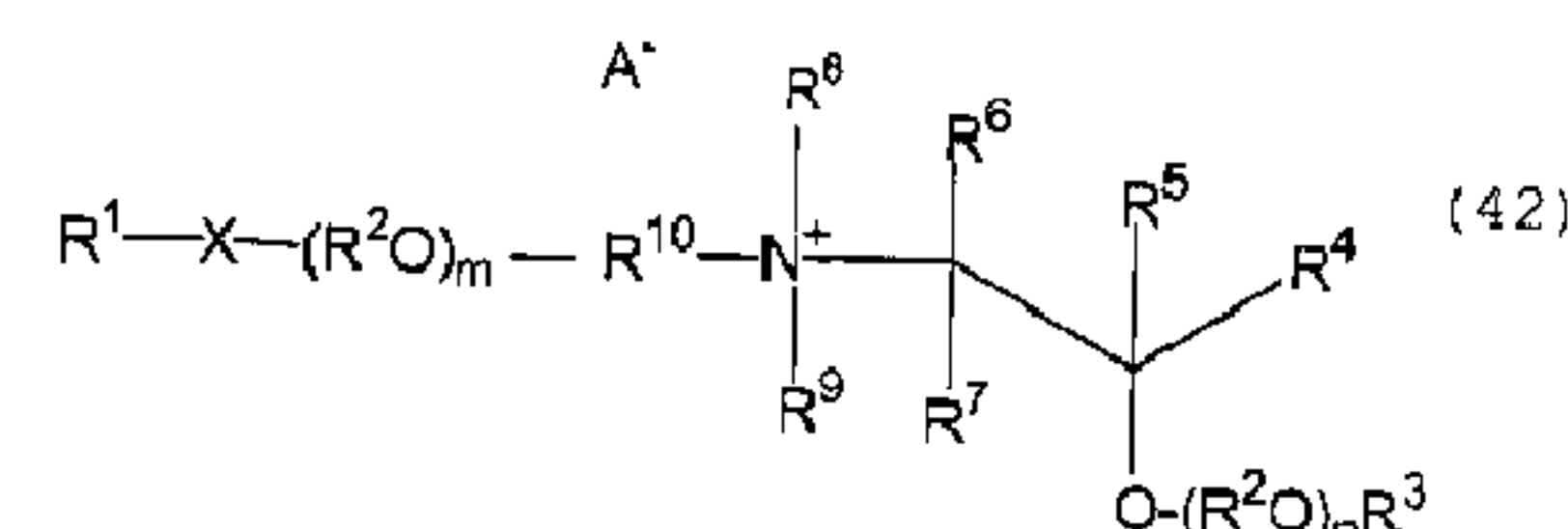
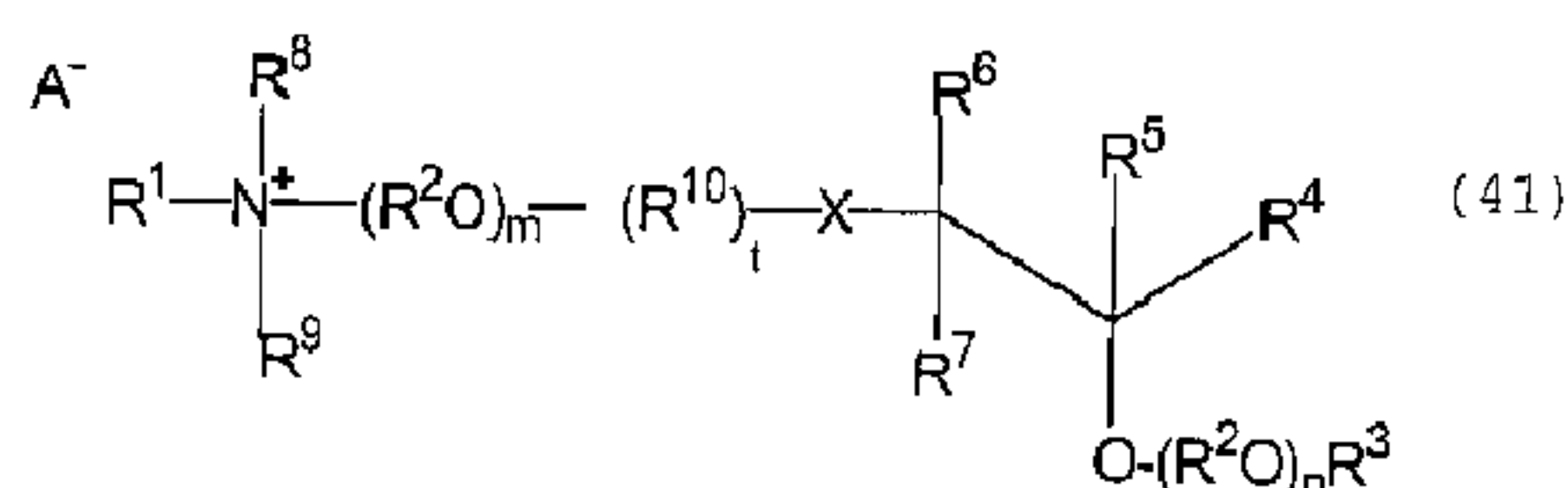
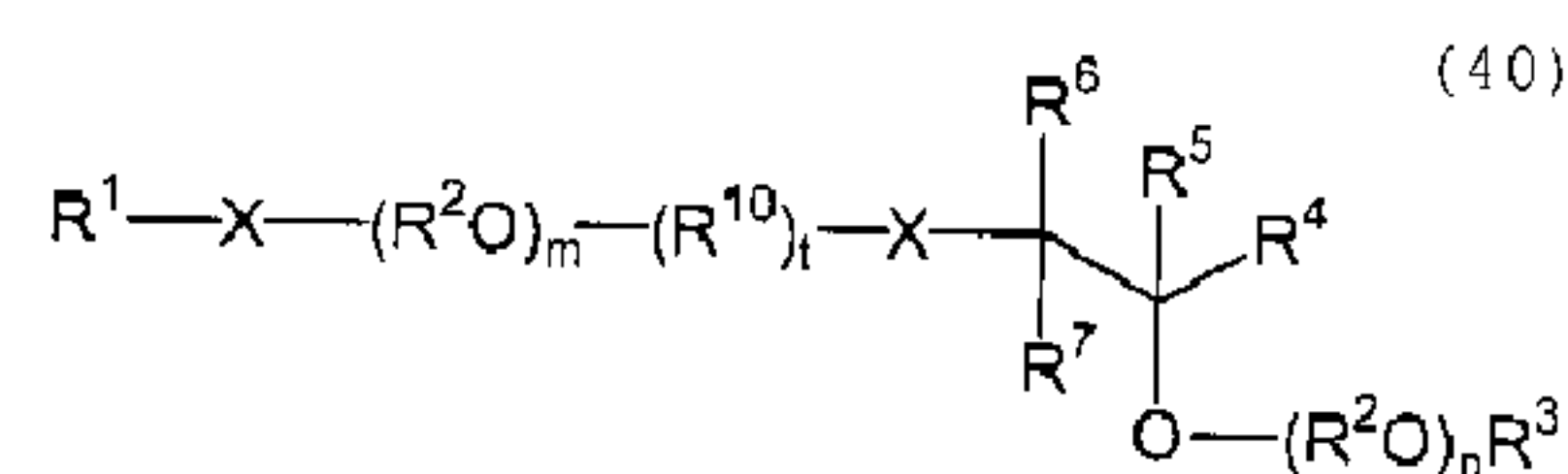
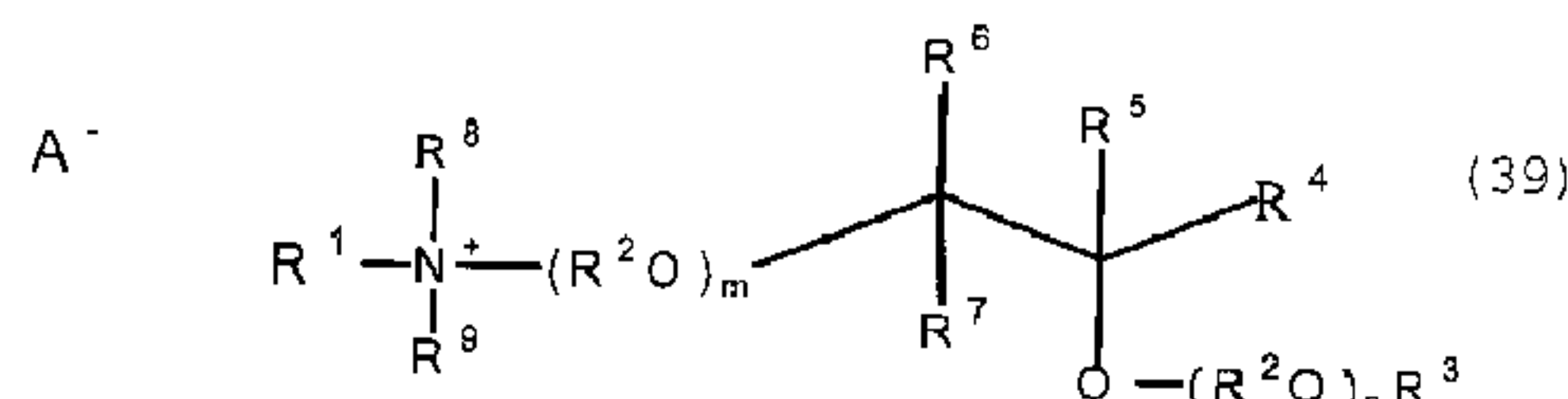
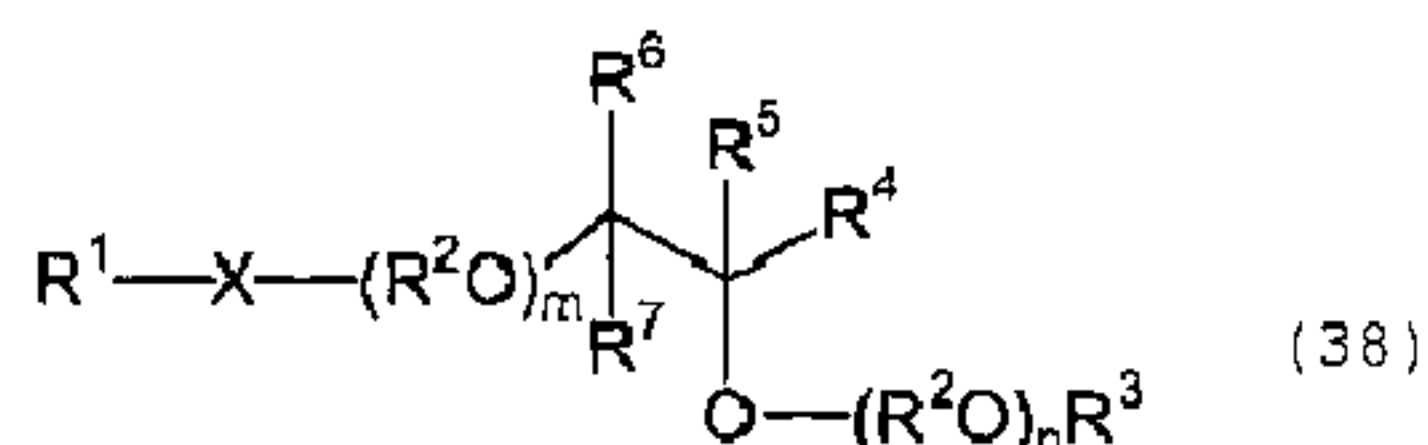
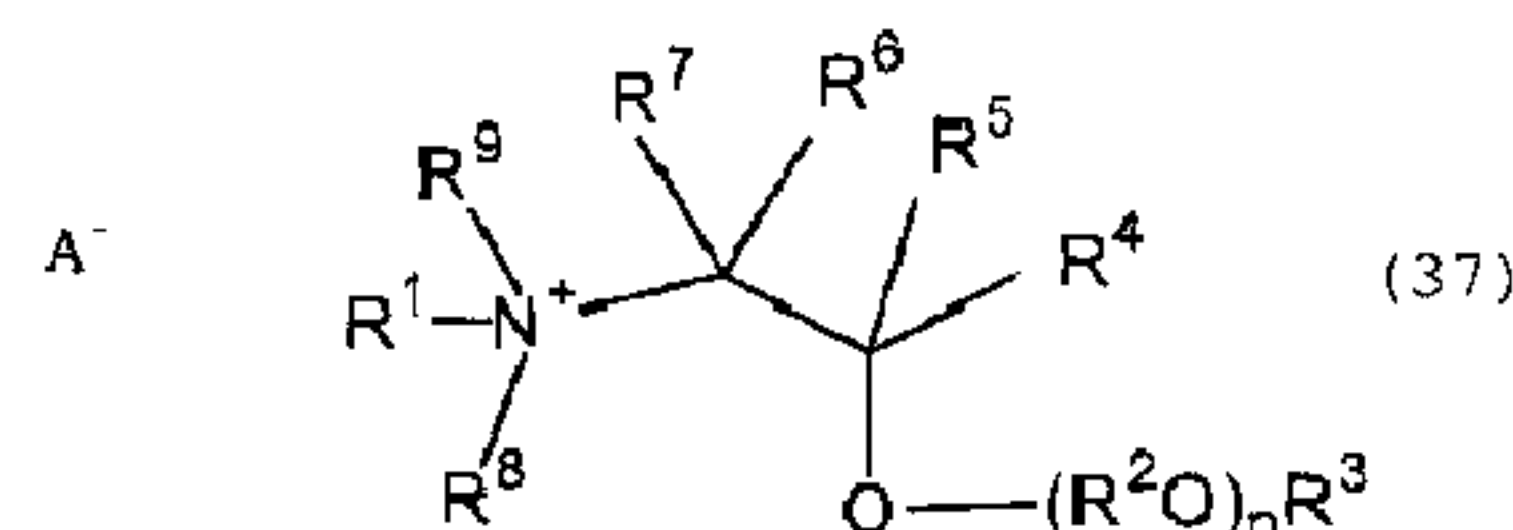
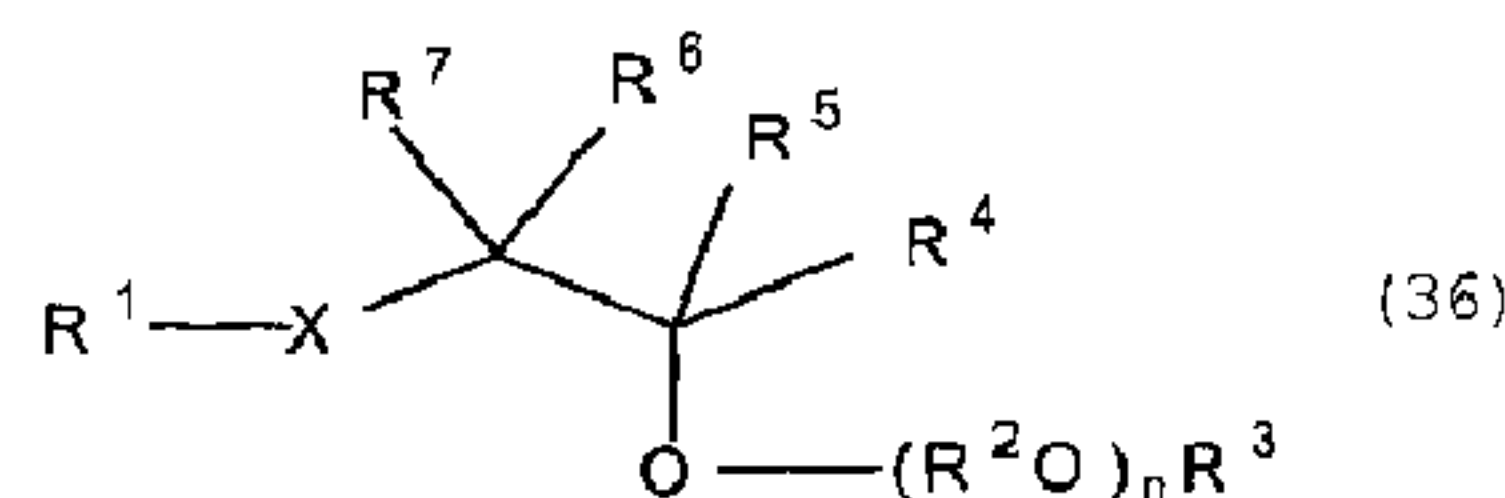
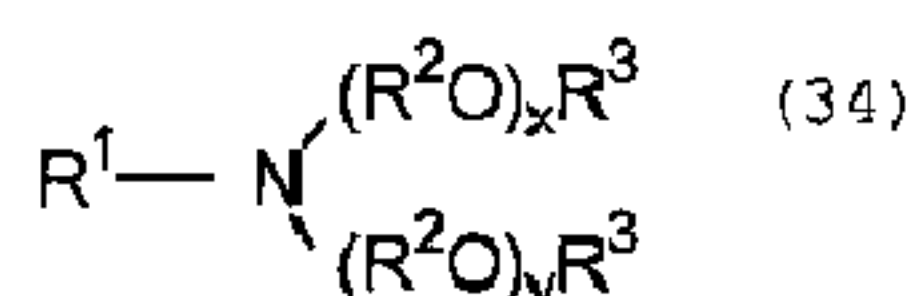
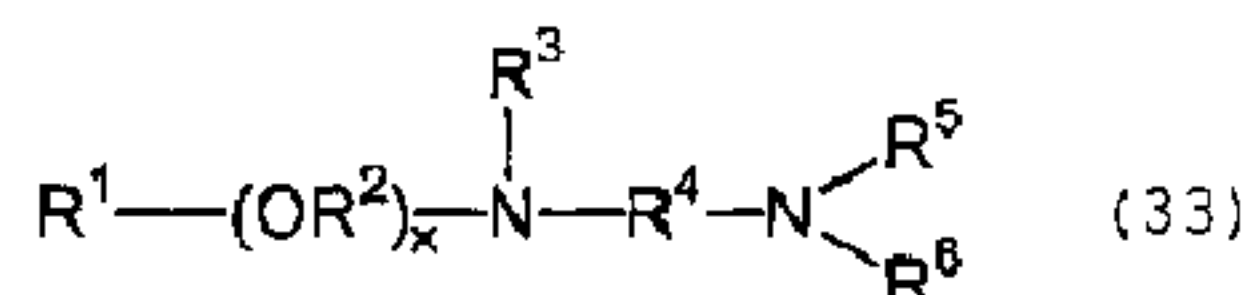
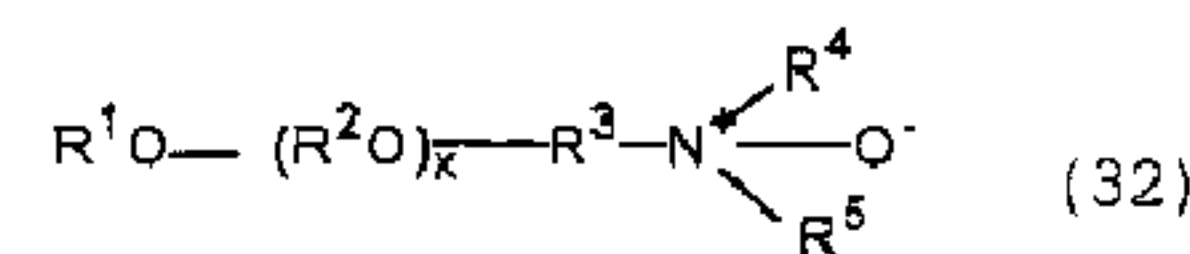
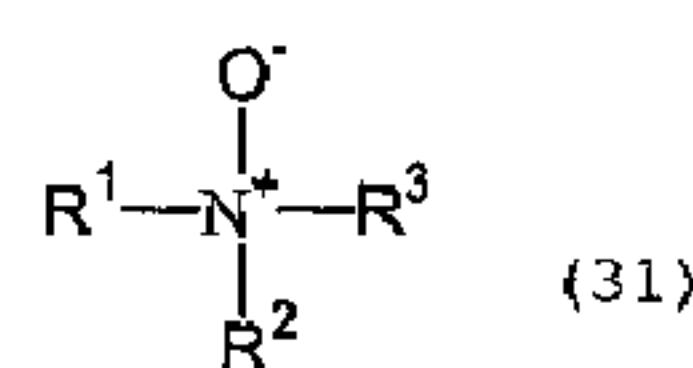
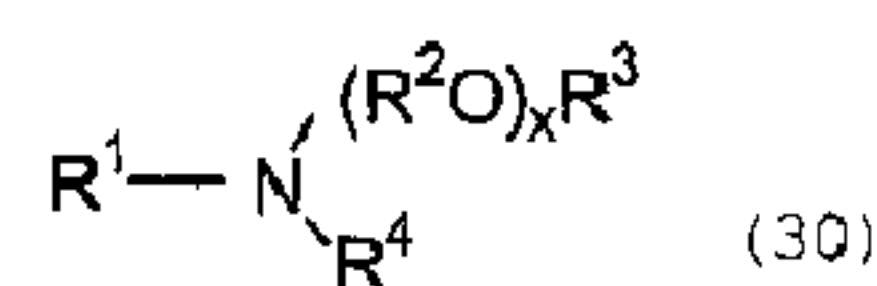
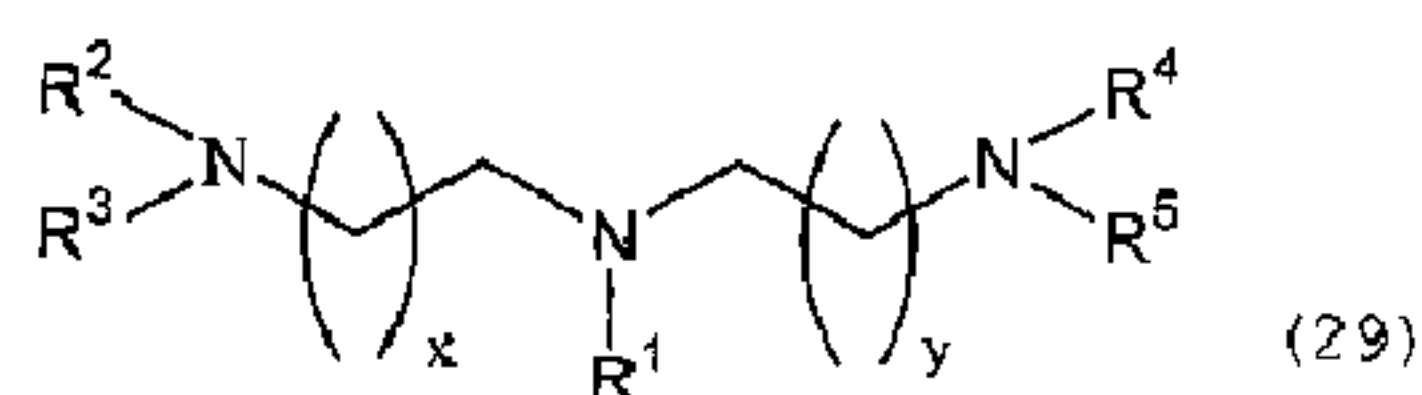
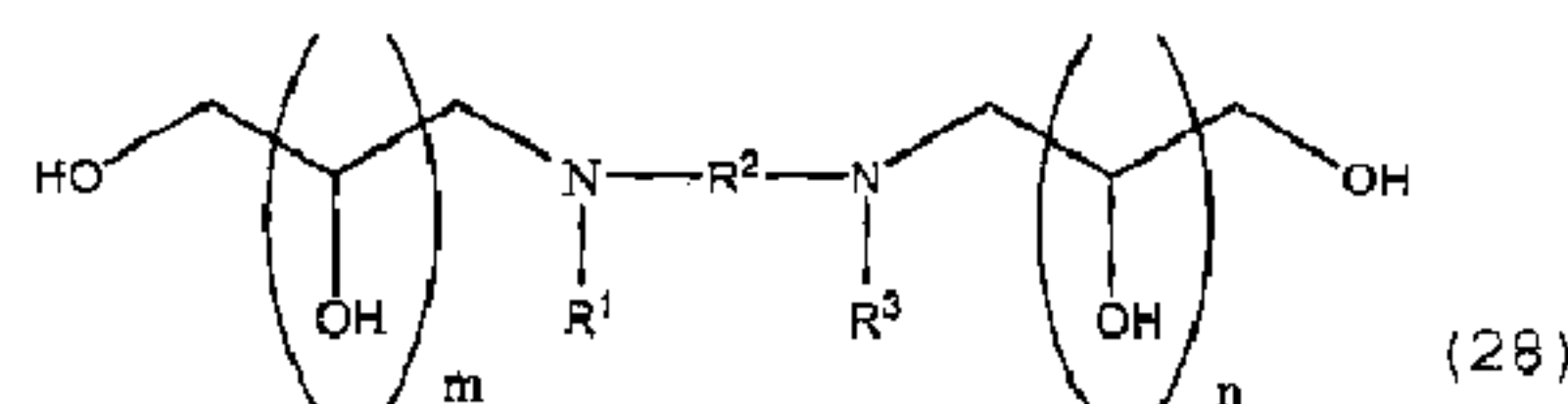
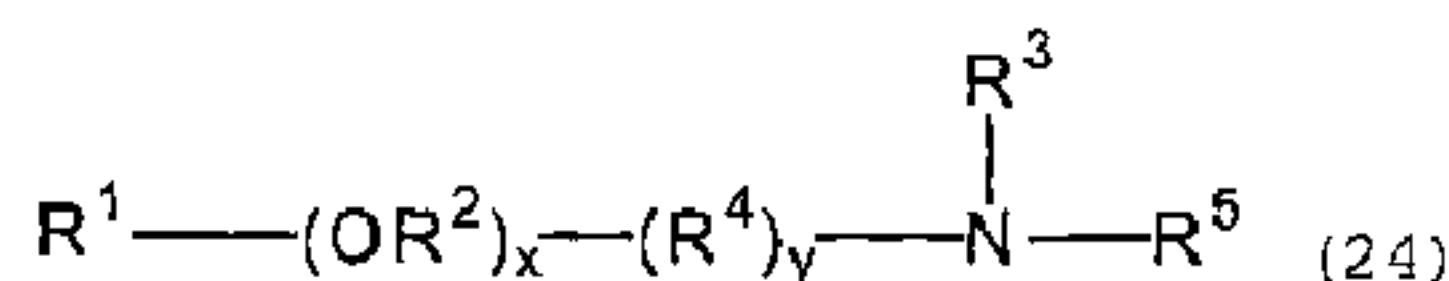
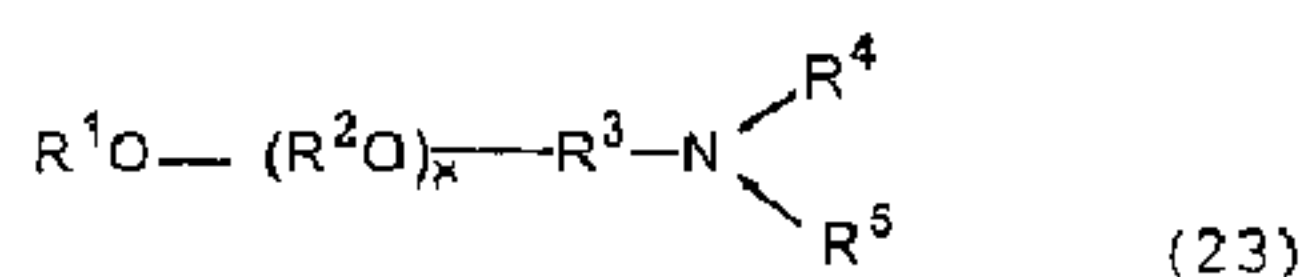

(57) Abrégé/Abstract:

Provided are surfactant compounds selected from (a) monoalkoxylated amines having the formula (see formula 23); (b) alkoxyated poly(hydroxyalkyl)amines having the formula (see formula 24); (c) di-poly(hydroxyalkyl)amines having the formula (see formula 28); (d) alkoxyated triamines having the formula (see formula 29); (e) monoalkylated amines having the formula (see formula 30);



(72) **Inventeurs(suite)/Inventors(continued)**: BECHER, DAVID Z., US; WRIGHT, DANIEL L., US; AGBAJE, HENRY E., US; XU, XIAODONG C., US; ABRAHAM, WILLIAM, US; BRINKER, RONALD J., US; PALLAS, NORMAN R., US; WIDEMAN, AL S., US; MAHONEY, MARTIN D., US; HENKE, SUSAN L., US

(73) **Propriétaires(suite)/Owners(continued)**: MONSANTO TECHNOLOGY, LLC, US

(74) **Agent**: MCFADDEN, FINCHAM

(57) **Abrégé(suite)/Abstract(continued)**:

(f) alkoxyated amine oxides having the formula (see formula 31); (g) alkoxyated amine oxides having the formula (see formula 32); (h) alkoxyated diamines having the formula (see formula 33); (i) dialkoxyated amines having the formula (see formula 34); (j) dialkoxyated alcohols having the formula $R^1(OR^2)_xO-R^3-O-(R^2O)_yR^1$ (35); and (k) compounds of the formula (see formula 36) (see formula 37) (see formula 38) (see formula 39) (see formula 40) (see formula 41) (see formula 42) and (see formula 43). These compounds are useful as surfactants and may be used in an aqueous pesticidal formulation.

64725-903 (D)

SURFACTANTS SUITABLE FOR USEIN POTASSIUM GLYPHOSATE FORMULATIONSABSTRACT

Provided are surfactant compounds selected from

5 (a) monoalkoxylated amines having the formula

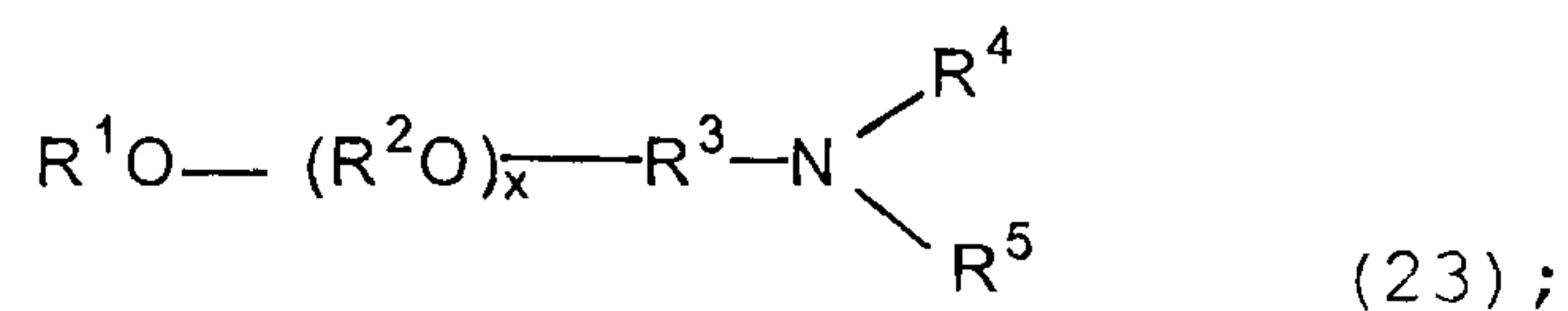

(b) alkoxyated poly(hydroxyalkyl)amines having the formula

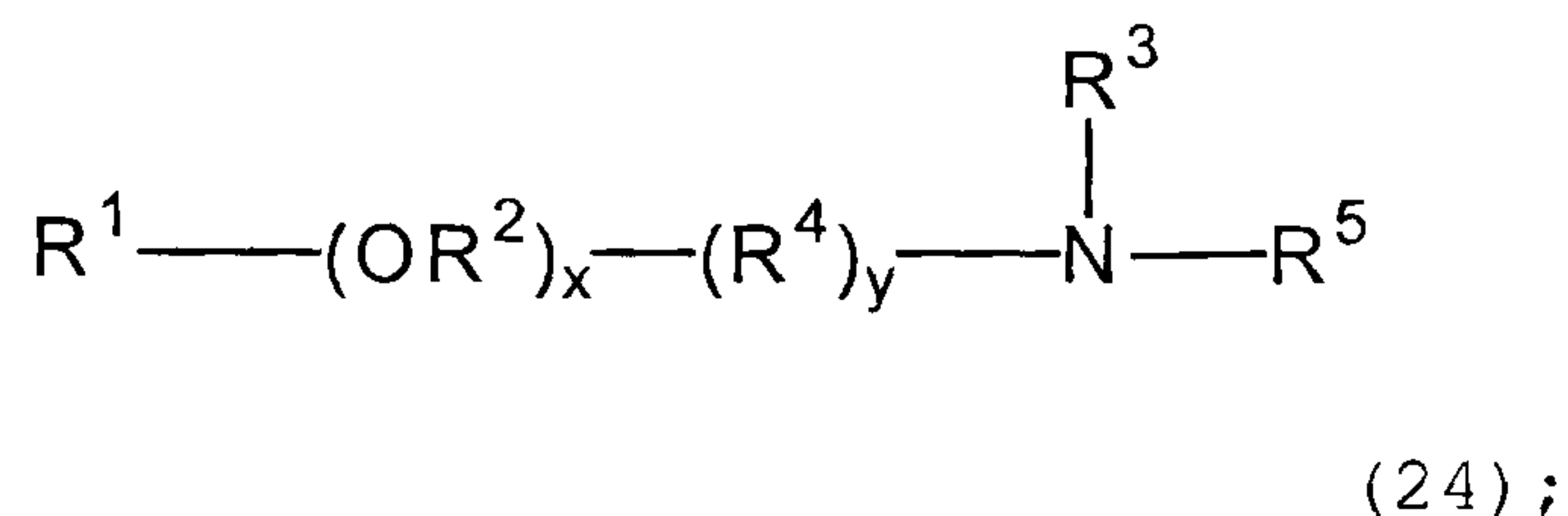

10

(c) di-poly(hydroxyalkyl)amines having the formula

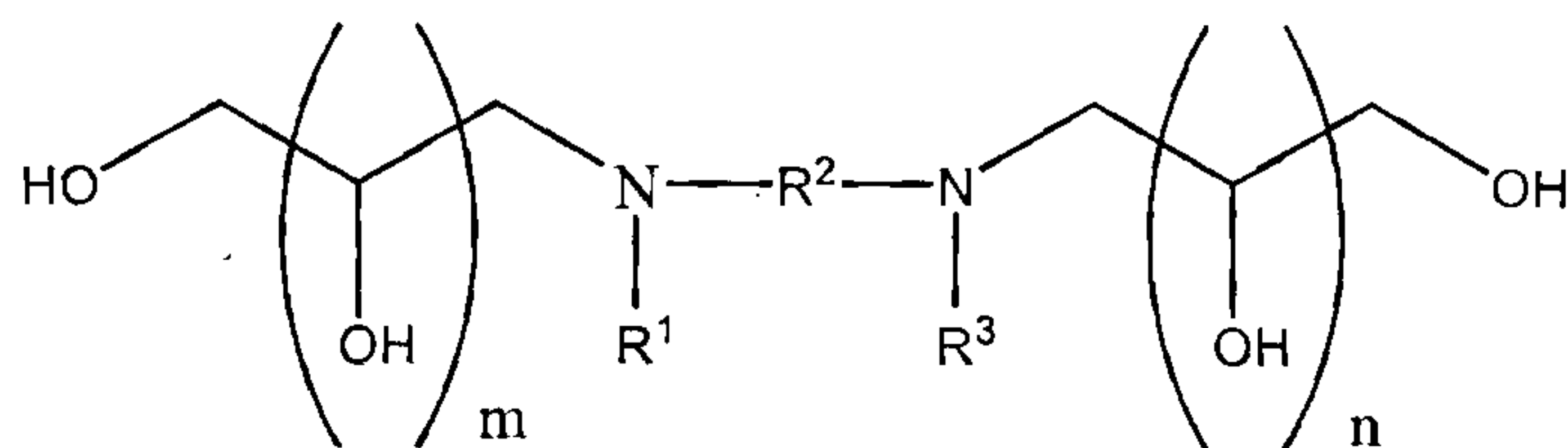

(28);

(d) alkoxyated triamines having the formula

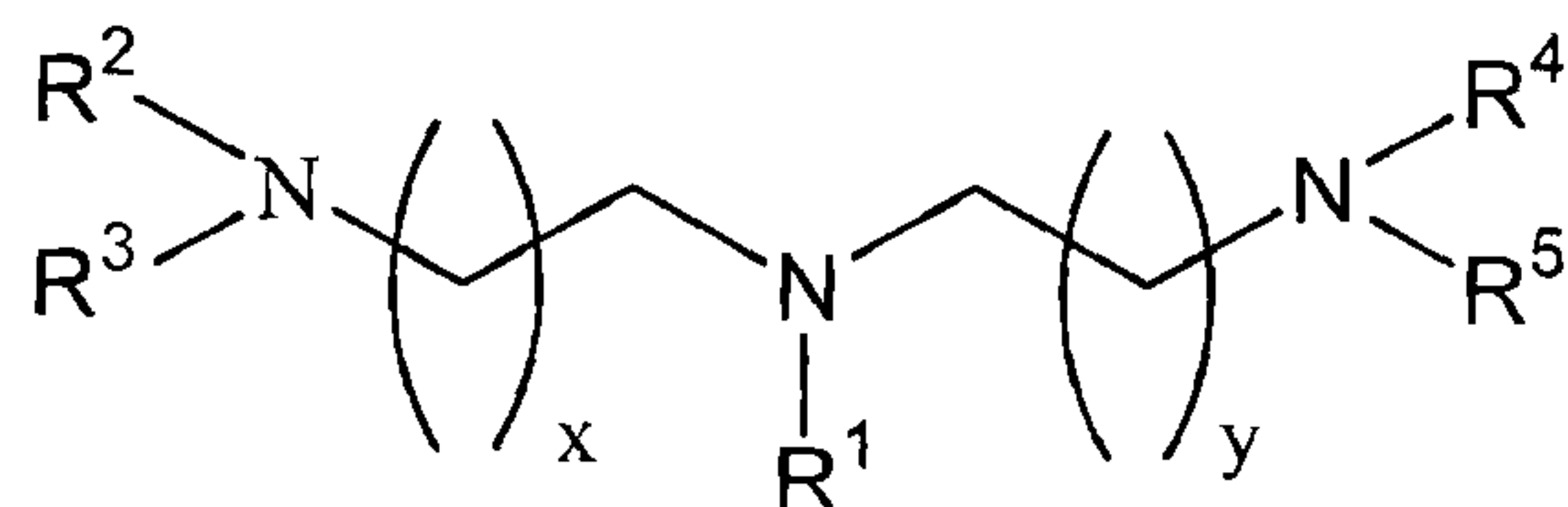

(29);

64725-903 (D)

(e) monoalkylated amines having the formula

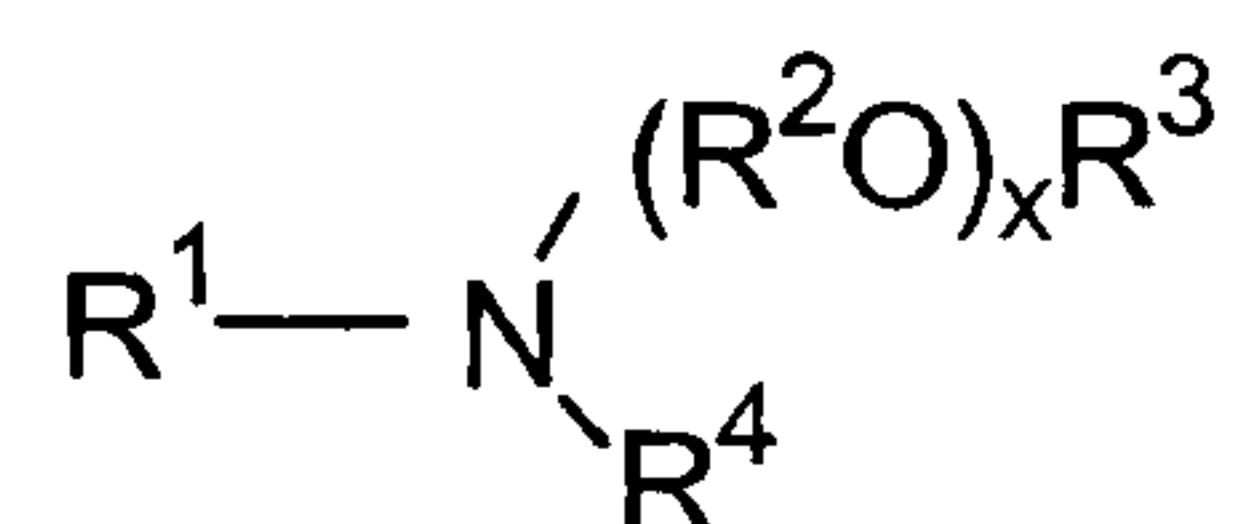

(30);

(f) alkoxyated amine oxides having the formula

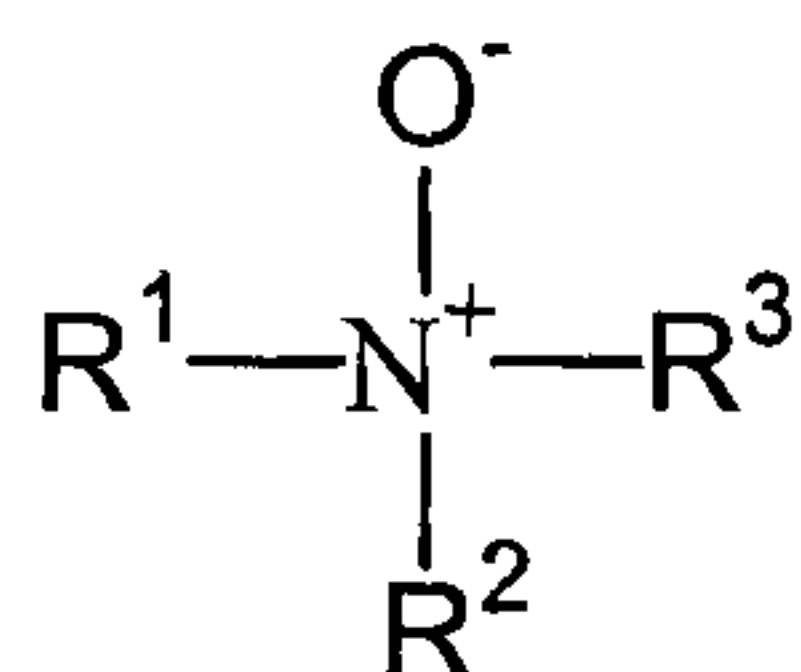

5

(31);

(g) alkoxyated amine oxides having the formula

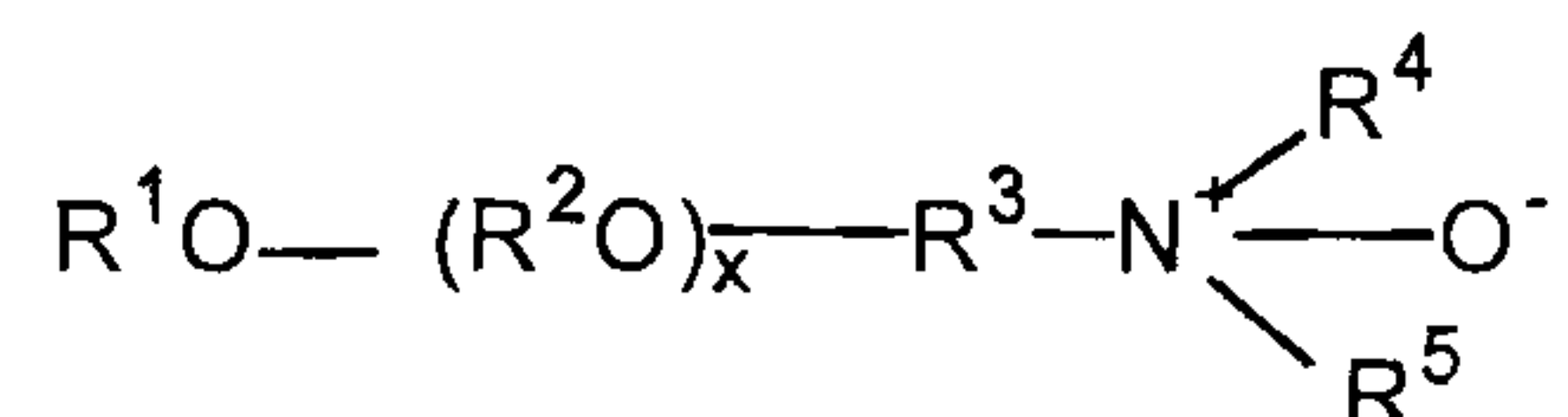

(32);

10

(h) alkoxyated diamines having the formula

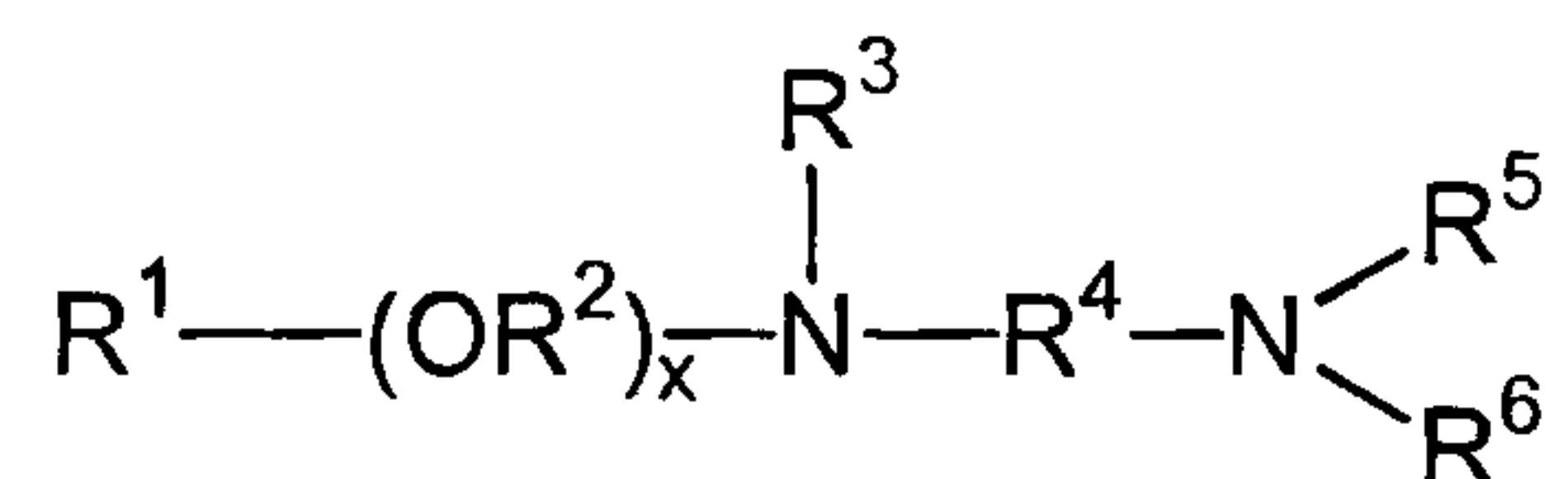

(33);

(i) dialkoxyated amines having the formula

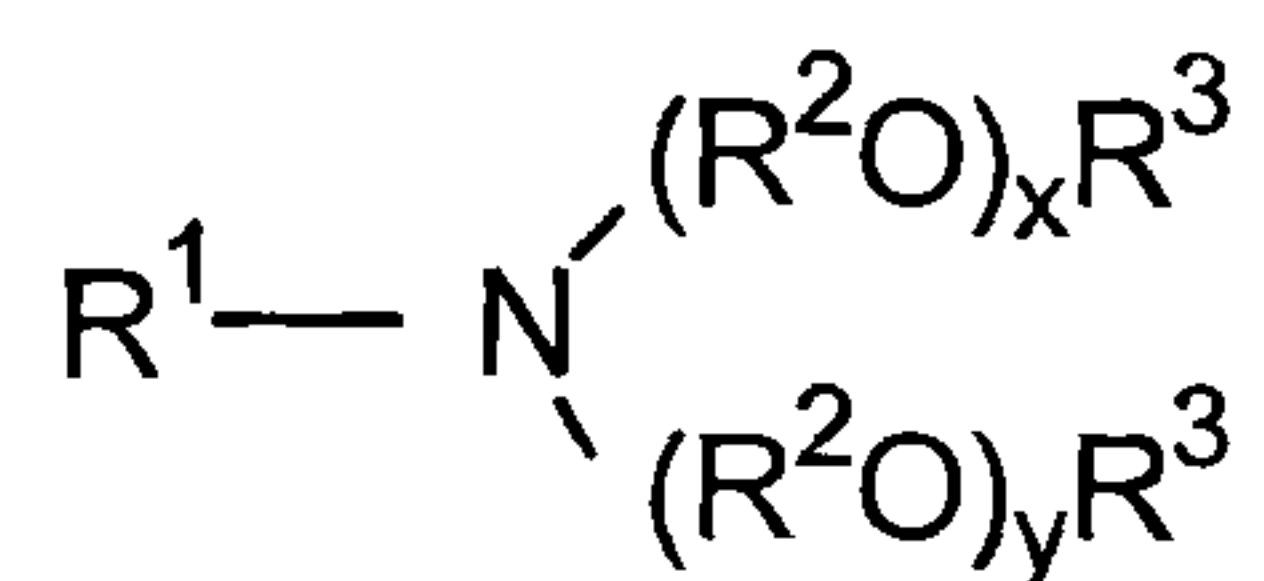

(34);

64725-903(D)

(j) dialkoxylated alcohols having the formula

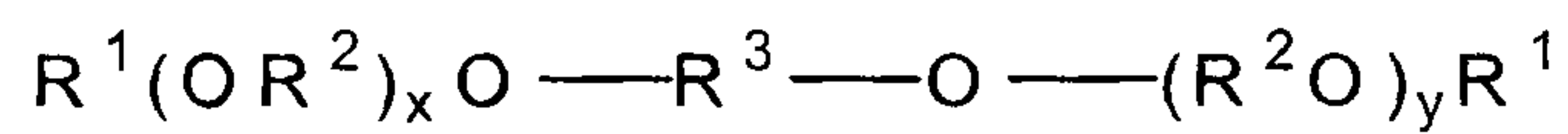

(35);

and

5

(k) compounds of the formula

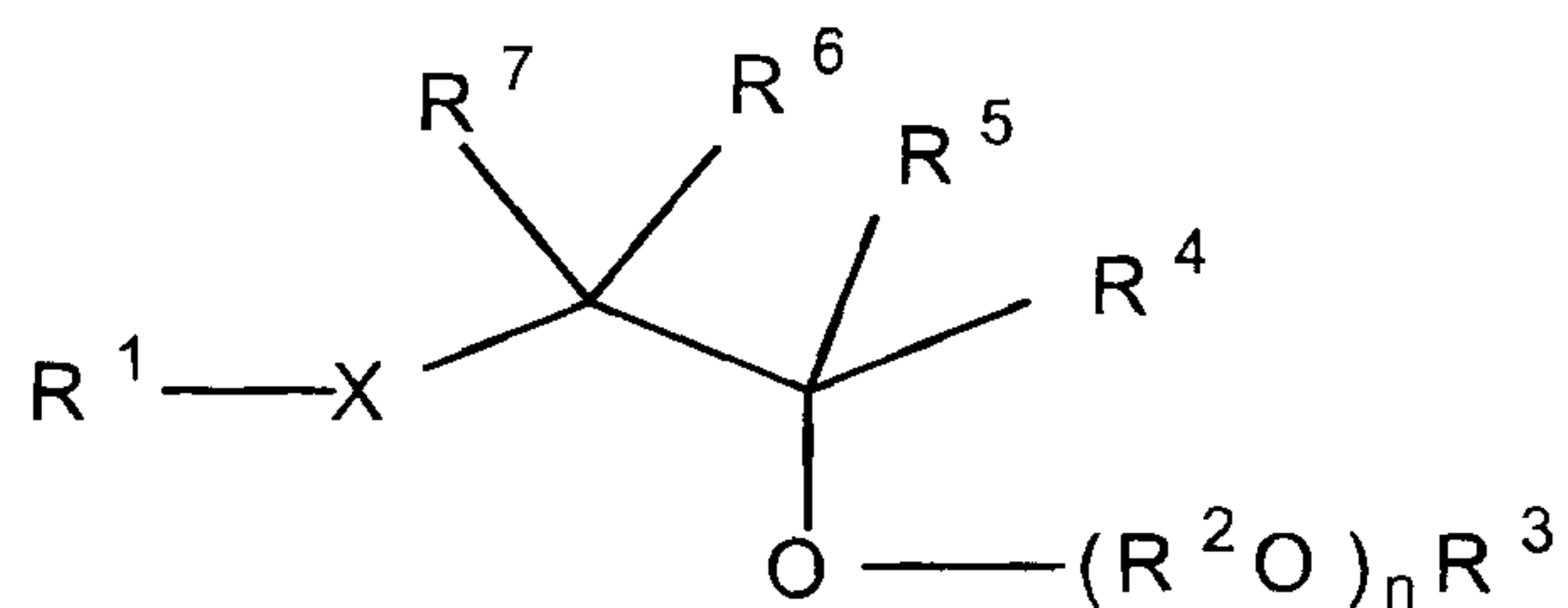

(36)

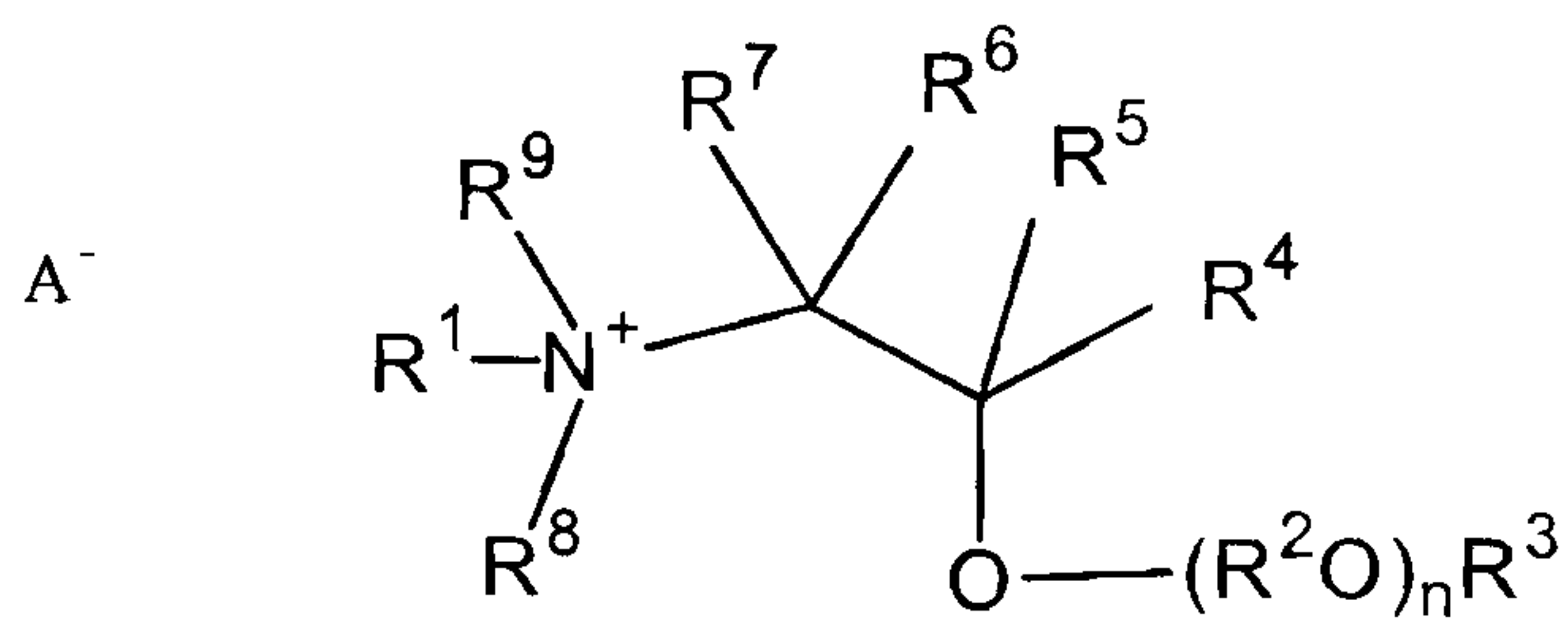

(37)

10

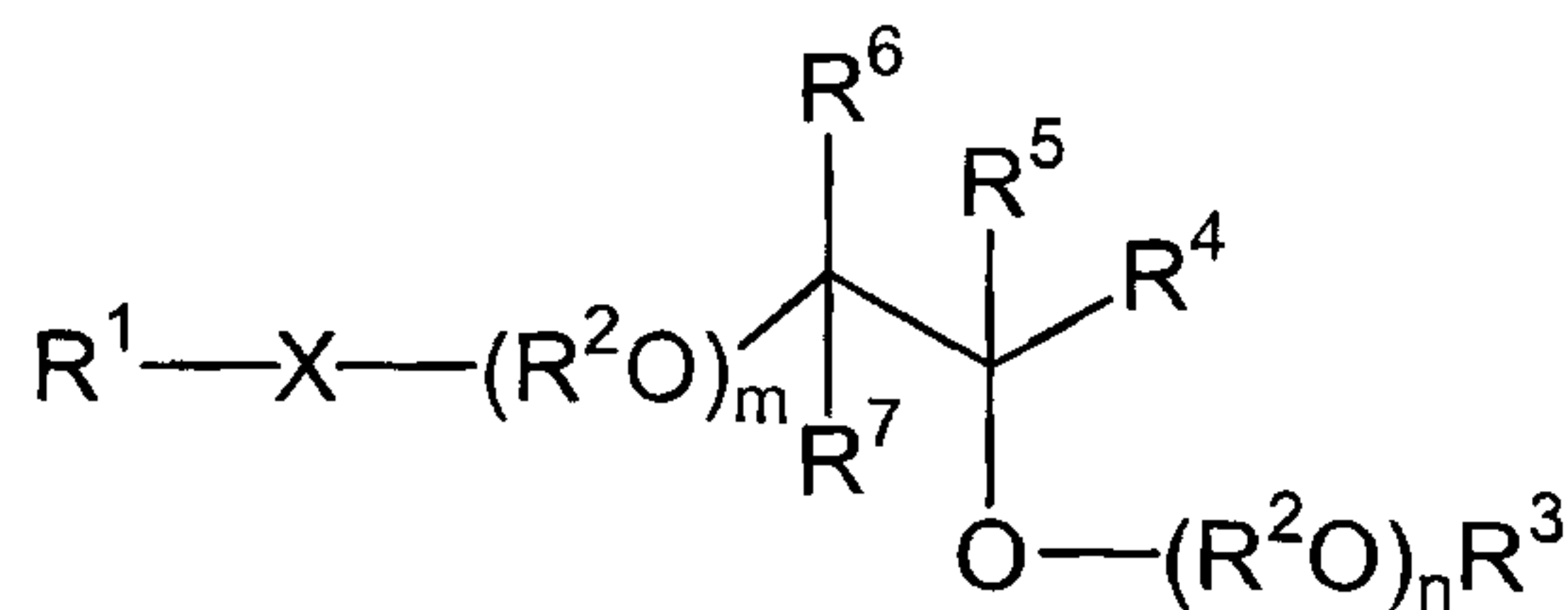

(38)

64725-903 (D)

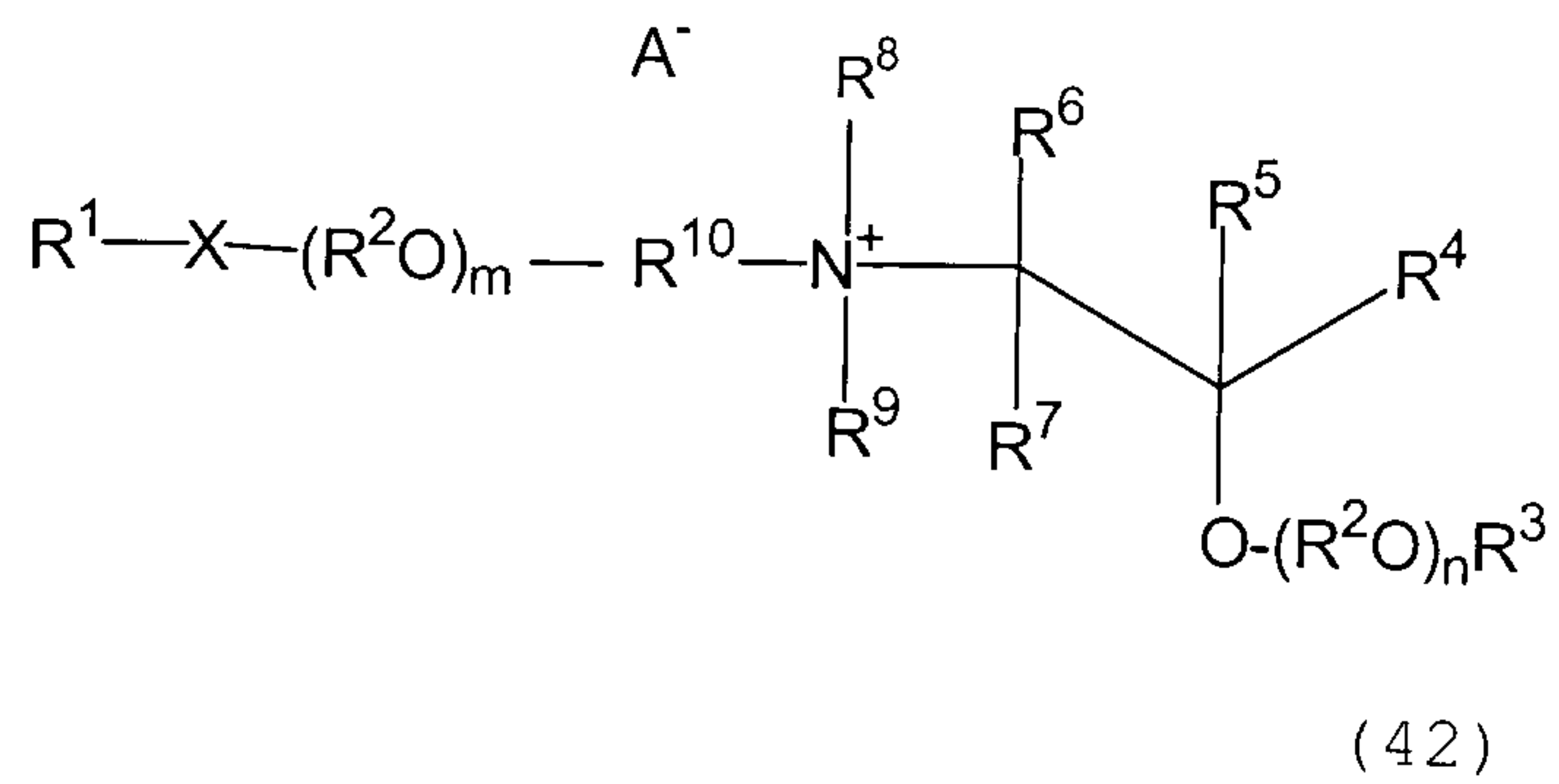
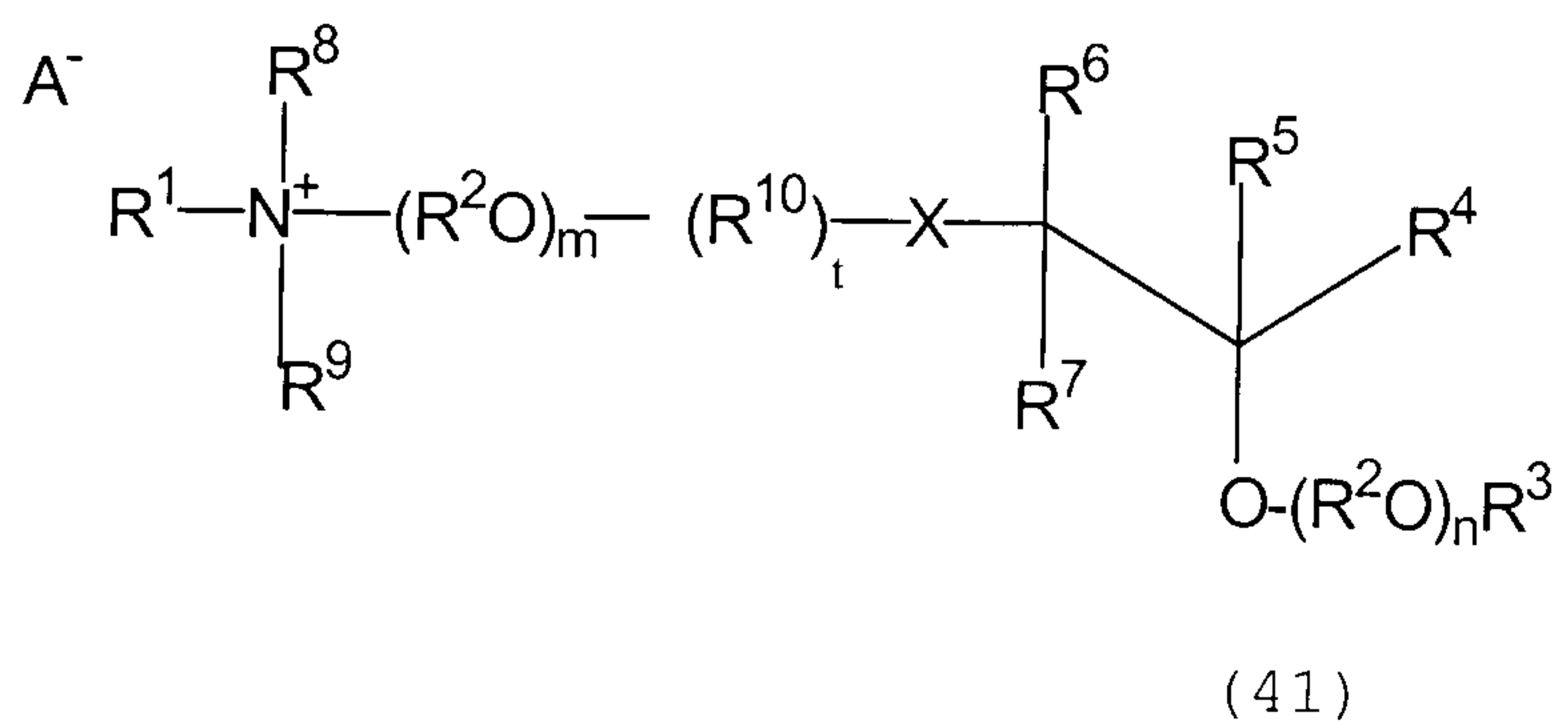
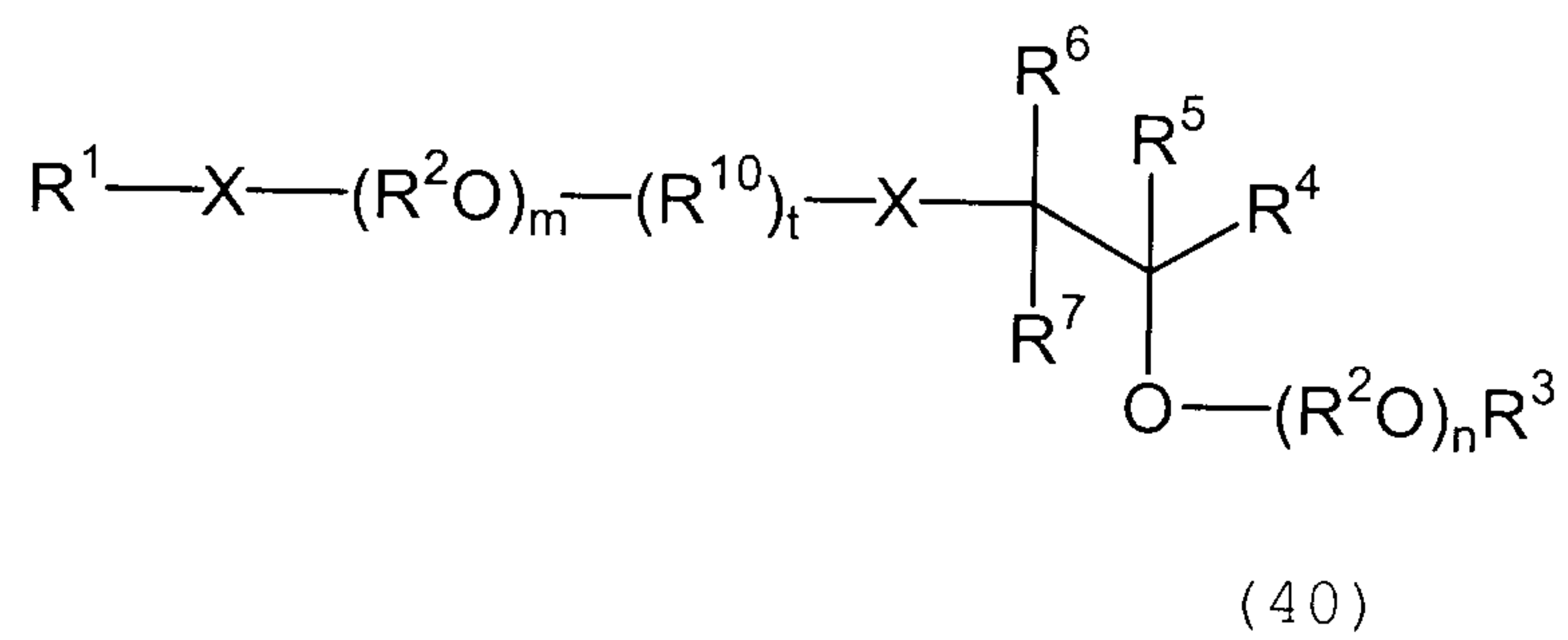
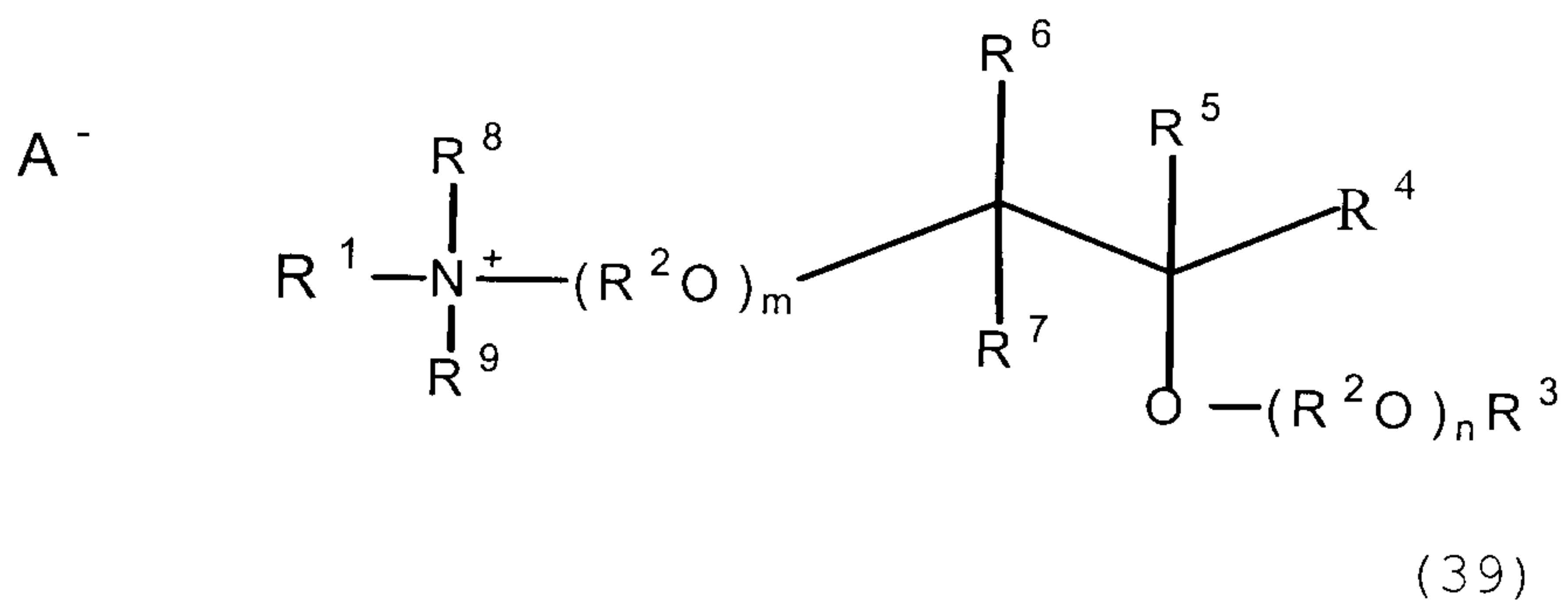

64725-903 (D)

and

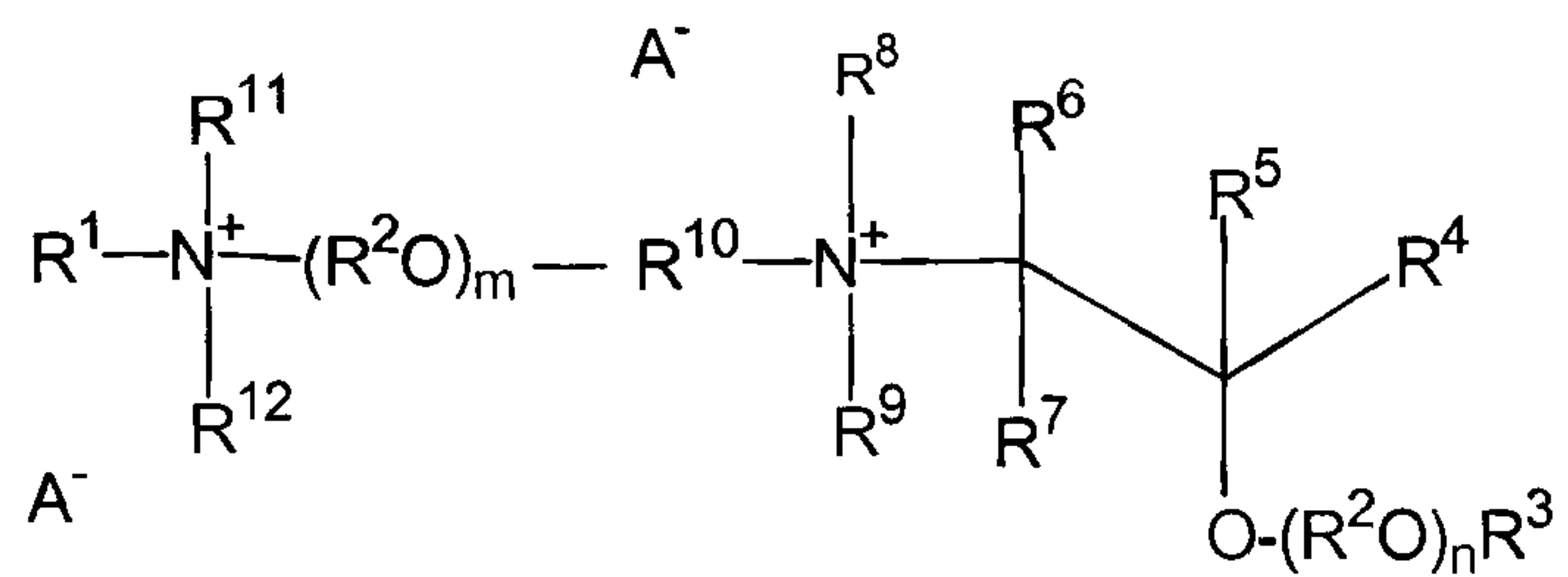

(43) .

These compounds are useful as surfactants and may be used in an aqueous pesticidal formulation.

DEMANDES OU BREVETS VOLUMINEUX

**LA PRÉSENTE PARTIE DE CETTE DEMANDE OU CE BREVETS
COMPREND PLUS D'UN TOME.**

CECI EST LE TOME __1__ DE __2__

NOTE: Pour les tomes additionels, veuillez contacter le Bureau Canadien des Brevets.

JUMBO APPLICATIONS / PATENTS

**THIS SECTION OF THE APPLICATION / PATENT CONTAINS MORE
THAN ONE VOLUME.**

THIS IS VOLUME __1__ OF __2__

NOTE: For additional volumes please contact the Canadian Patent Office.

SURFACTANTS SUITABLE FOR USE IN
POTASSIUM GLYPHOSATE FORMULATIONS

FIELD OF THE INVENTION

The present invention relates to aqueous pesticide formulations containing high concentrations of a herbicide, such as the potassium salt of glyphosate, together with surfactants or other adjuvants, including formulations which form anisotropic aggregates (AA) or liquid crystals (LC) on or in the foliage of a plant. More specifically, the present invention relates to glyphosate containing herbicidal formulations containing one or more surfactants that form anisotropic aggregates and/or liquid crystals to facilitate the introduction, uptake and translocation of glyphosate throughout the plant. Methods of killing or controlling unwanted vegetation using such formulations are also described. The invention also relates to novel surfactants and pesticide compositions containing such surfactants.

The present divisional application is divided out of Application No. 2,407,751 filed May 21, 2001 (the parent application).

The invention of the parent application relates to pesticidal and herbicidal formulations.

The invention of the present divisional application relates to novel surfactants. These surfactants are suited for use in pesticidal and herbicidal formulations such as those described herein.

BACKGROUND OF THE INVENTION

Glyphosate is well known in the art as an effective post-emergent foliar-applied herbicide. In its acid form, glyphosate has a structure represented by formula (1):

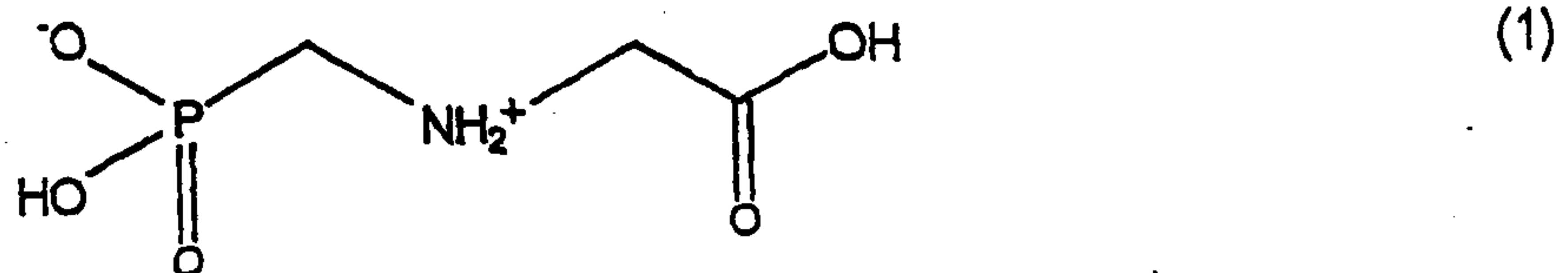

and is relatively insoluble in water (1.16% by weight at 25°C). For this reason it is typically formulated as a water-soluble salt.

64725-903 (D)

1a

Monobasic, dibasic and tribasic salts of glyphosate can be made. However, it is generally preferred to formulate glyphosate and apply glyphosate to plants in the form of a monobasic salt. The most widely used salt of glyphosate is the mono(isopropylammonium), often abbreviated to IPA, salt. Commercial herbicides of Monsanto Company having the IPA salt of glyphosate as active ingredient include Roundup®, Roundup® Ultra, Roundup® Xtra and Rodeo® herbicides. All of these are aqueous solution concentrate (SL) formulations and are generally diluted in water by the user prior to application to plant foliage. Another glyphosate salt which have been commercially formulated as SL formulations include the trimethylsulfonium, often abbreviated to TMS, salt, used

for example in Touchdown® herbicide of Zeneca (Syngenta).

Various salts of glyphosate, methods for preparing salts of glyphosate, formulations of glyphosate or its salts and methods of use of glyphosate or its salts for killing and controlling weeds and other plants are disclosed in U.S. Patent No. 4,507,250 to Bakel, U.S. Patent No. 4,481,026 to Prisbylla, U.S. Patent No. 4,405,531 to Franz, U.S. Patent No. 4,315,765 to Large, U.S. Patent No. 4,140,513 to Prill, U.S. Patent No. 3,977,860 to Franz, U.S. Patent No. 3,853,530 to Franz, and U.S. Patent No. 3,799,758 to Franz.

Among the water soluble salts of glyphosate known in the literature, but never used commercially before the priority filing date hereof, is the potassium salt, having a structure represented by formula (2):

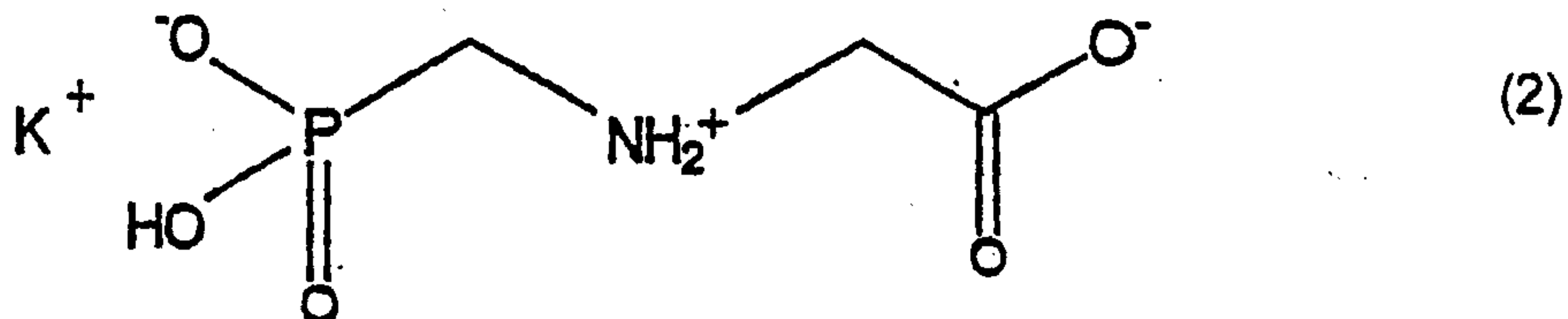

in the ionic form predominantly present in aqueous solution at a pH of about 4. Glyphosate potassium salt has a molecular weight of 207. This salt is disclosed, for example, by Franz in U.S. Patent No. 4,405,531 cited above, as one of the "alkali metal" salts of glyphosate useful as herbicides, with potassium being specifically disclosed as one of the alkali metals, along with lithium, sodium, cesium and rubidium. Example C discloses the preparation of the monopotassium salt by reacting the specified amounts of glyphosate acid and potassium carbonate in an aqueous medium.

Very few herbicides have been commercialized as their potassium salts. The Pesticide Manual, 11th Edition, 1997, lists as potassium salts the auxin type herbicides 2,4-DB ((2,4-dichlorophenoxy)butanoic acid), dicamba (3,6-dichloro-2-methoxybenzoic acid), dichlorprop (2-(2,4-dichlorophenoxy)propanoic acid), MCPA ((4-chloro-2-methylphenoxy)acetic acid), and picloram (4-amino-3,5,6-trichloro-2-pyridinecarboxylic acid), the active ingredient of certain herbicide products sold by Dow Agrosiences under the trademark Tordon.

The solubility of glyphosate potassium salt in water is recorded in U.S. Patent No. 6,544,936 to Wright. As disclosed therein, glyphosate potassium salt has a solubility in pure water at 20°C of about 54% by weight, that

64725-903 (D)

3

is, about 44% glyphosate acid equivalent (a.e.) by weight. This is very similar to the solubility of the IPA salt. Concentrations expressed as percent by weight herein relate to parts by weight of salt or acid equivalent per 100 parts by weight of solution. Thus a simple aqueous solution concentrate of glyphosate potassium salt can readily be provided at a concentration of, for example, 44% a.e. by weight, comparable to that commercially obtainable with glyphosate IPA salt, as in the aqueous solution concentrate available from Monsanto Company under the name Roundup® D-Pak™. Somewhat higher concentrations can be obtained by slight overneutralization, 5 to 10% for example, of an aqueous solution of glyphosate potassium salt with potassium hydroxide.

A major advantage of the IPA salt over many other salts of glyphosate has been the good compatibility in aqueous solution concentrate formulations of that salt with a wide range of surfactants. As used herein, the term "surfactant" is intended to include a wide range of adjuvants that can be added to herbicidal glyphosate compositions to enhance the herbicidal efficacy thereof, as compared to the activity of the glyphosate salt in the absence of such adjuvant, stability, formulability or other beneficial solution property, irrespective of whether such adjuvant meets a more traditional definition of "surfactant."

Glyphosate salts generally require the presence of a suitable surfactant for best herbicidal performance. The surfactant can be provided in the concentrate formulation, or it can be added by the end user to the diluted spray composition. The choice of surfactant has a major bearing on herbicidal performance. For example, in an extensive study reported in *Weed Science*, 1977, volume 25, pages 275-287, Wyrill and Burnside found wide variation among surfactants in their ability to enhance the herbicidal efficacy of glyphosate, applied as the IPA salt.

Beyond some broad generalizations, the relative ability of different surfactants to enhance the herbicidal effectiveness of glyphosate is highly unpredictable.

Surfactants tending to give the most useful enhancement of glyphosate herbicidal effectiveness are generally but not exclusively cationic surfactants, including surfactants which form cations in aqueous solution or dispersion at pH levels of around 4-5 characteristic of SL formulations of monobasic salts of glyphosate. Examples are long-chain (typically C₁₂ to C₁₈) tertiary alkylamine surfactants and quaternary alkylammonium surfactants. An especially common tertiary alkylamine surfactant used in aqueous solution concentrate formulations

64725-903 (D)

4

of glyphosate IPA salt has been the very hydrophilic surfactant polyoxyethylene (15) tallowamine, *i.e.*, tallowamine having in total about 15 moles of ethylene oxide in two polymerized ethylene oxide chains attached to the amine group as shown in formula (3):

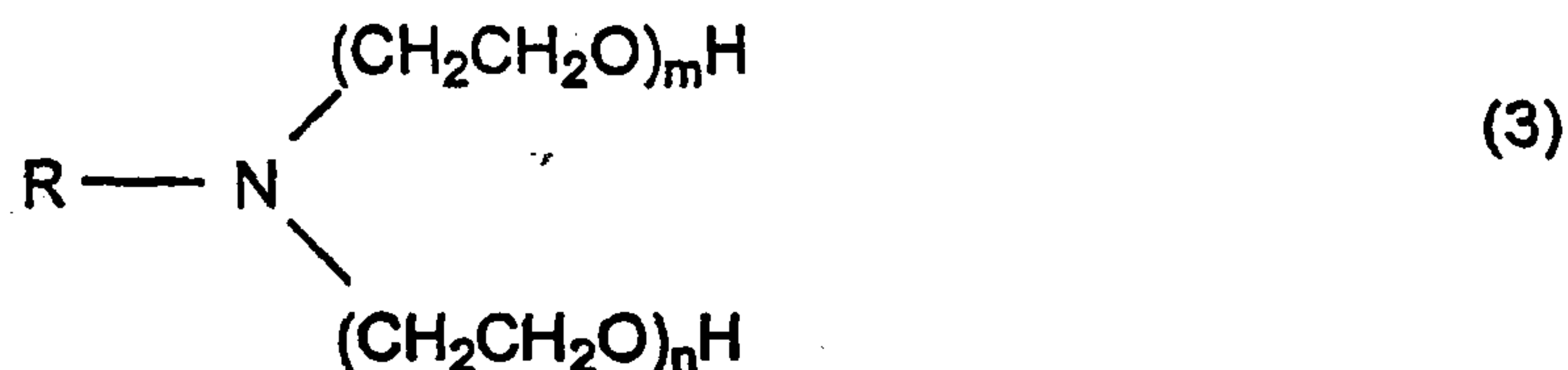

wherein R is a mixture of predominantly C₁₆ and C₁₈ alkyl and alkenyl chains derived from tallow and the total of m+n is an average number of about 15.

For certain applications, it has been found desirable to use a somewhat less hydrophilic alkylamine surfactant, such as one having less than about 10 moles of ethylene oxide, as suggested in U.S. Patent No. 5,668,085 to Forbes et al., for example polyoxyethylene (2) cocoamine. That patent discloses illustrative aqueous compositions comprising such a surfactant together with the IPA, ammonium or potassium salts of glyphosate. The highest concentration of glyphosate in the potassium salt formulations shown in Table 3 of the '085 patent is 300 g glyphosate a.e./l, with a weight ratio of glyphosate a.e. to surfactant of 2:1.

A class of alkoxyated alkylamines is disclosed in WO 00/59302 for use in herbicidal spray compositions. Potassium glyphosate solutions including various Jeffamine™ EO/PO propylamines or propyldiamines are described therein.

A wide variety of quaternary ammonium surfactants have been disclosed as components of aqueous solution concentrate formulations of glyphosate IPA salt. Illustrative examples are N-methylpolyoxyethylene (2) cocoammonium chloride, disclosed in European Patent No. 0274369, N-methylpolyoxyethylene (15) cocoammonium chloride, disclosed in U.S. Patent No. 5,317,003, and various quaternary ammonium compounds having formula (4):



where R¹, R² and R³ are each C₁₋₃ alkyl groups and n is an average number from 2 to 20, disclosed in U.S. Patent No. 5,464,807.

PCT Publication No. WO 97/16969 discloses aqueous solution concentrate compositions of glyphosate, in the form of the IPA, methylammonium and

diammonium salts, comprising a quaternary ammonium surfactant and an acid salt of a primary, secondary or tertiary alkylamine compound.

Other cationic surfactants which have been indicated as useful in aqueous solution concentrate compositions of glyphosate salts include those disclosed in PCT Publication No. WO 95/33379. It is further disclosed in PCT Publication No. WO 97/32476 that highly concentrated aqueous compositions of glyphosate salts can be made with certain of these same cationic surfactants, with the further addition of a defined component that enhances stability of the compositions. Glyphosate salts exemplified therein are the IPA salt and the mono- and diammonium salts.

Among amphoteric or zwitterionic surfactants reported to be useful components of aqueous solution concentrate formulations of glyphosate IPA salt are alkylamine oxides such as polyoxyethylene (10-20) tallowamine oxide, disclosed in U.S. Patent No. 5,118,444.

Nonionic surfactants are generally reported to be less effective in enhancing herbicidal activity than cationic or amphoteric surfactants when used as the sole surfactant component of SL formulations of glyphosate IPA salt; exceptions appear to include certain alkyl polyglucosides, as disclosed for example in Australian Patent No. 627503, and polyoxyethylene (10-100) C₁₆₋₂₂ alkylethers, as disclosed in PCT Publication No. WO 98/17109. Anionic surfactants, except in combination with cationic surfactants as disclosed in U.S. Patent No. 5,389,598 and U.S. Patent No. 5,703,015, are generally of little interest in SL formulations of glyphosate IPA salt. The '015 patent discloses a surfactant blend of a dialkoxylated alkylamine and an anionic eye irritancy reducing compound. The surfactant blend is disclosed as being suitable for preparation of aqueous solution concentrate formulations of various glyphosate salts, the potassium salt being included in the list of salts mentioned. Concentrates of the '015 patent contain from about 5 to about 50%, preferably about 35% to about 45% glyphosate a.i. and from about 5 to about 25% surfactant. Further, PCT Publication No. WO 00/08927 discloses the use of certain polyalkoxylated phosphate esters in combination with certain polyalkoxylated amidoamines in glyphosate containing formulations. Potassium is identified as one of several salts of glyphosate noted as being "suitable."

Recently, a class of alkyletheramine, alkyletherammonium salt and alkyletheramine oxide surfactants has been disclosed in U.S. Patent No. 5,750,468 to be suitable for preparation of aqueous solution concentrate

formulations of various glyphosate salts, the potassium salt being included in the list of salts mentioned. It is disclosed therein that an advantage of the subject surfactants when used in an aqueous composition with glyphosate salts is that these surfactants permit the glyphosate concentration of the composition to be increased to very high levels.

It is likely that serious consideration of glyphosate potassium salt as a herbicidal active ingredient has been inhibited by the relative difficulty in formulating this salt as a highly concentrated SL product together with preferred surfactant types. For example, a widely used surfactant in glyphosate IPA salt compositions, namely polyoxyethylene (15) tallowamine of formula (3) above, is highly incompatible in aqueous solution with glyphosate potassium salt. Further, PCT Publication No. WO 00/15037 notes the low compatibility of alkoxyated alkylamine surfactants in general with high-strength glyphosate concentrates. As disclosed therein, in order to "build in" an effective level of surfactant, an alkylpolyglycoside surfactant is required in combination with an alkoxyated alkylamine surfactant to obtain high-strength concentrates containing the potassium salt of glyphosate.

The addition of such alkylpolyglycosides resulted in higher viscosity formulations (as compared to formulations without alkylpolyglycosides). Such an increase in the viscosity of these high-strength formulations is undesirable for various reasons. In addition to being more difficult to conveniently pour from the container or to wash residues therefrom, the deleterious effects resulting from higher viscosity formulations is more dramatically observed with respect to pumping requirements. Increasing volumes of liquid aqueous glyphosate products are being purchased by end-users in large refillable containers sometimes known as shuttles, which typically have an integral pump or connector for an external pump to permit transfer of liquid. Liquid aqueous glyphosate products are also shipped in bulk, in large tanks having a capacity of up to about 100,000 liters. The liquid is commonly transferred by pumping to a storage tank at a facility operated by a wholesaler, retailer or cooperative, from which it can be further transferred to shuttles or smaller containers for onward distribution. Because large quantities of glyphosate formulations are purchased and transported in early spring, the low temperature pumping characteristics of such formulations are extremely important.

When such alkylpolyglycosides (e.g., Agrimul™ APG-2067 and 2-ethylhexyl glucoside) are added to a glyphosate concentrate, the formulated product is

64725-903 (D)

7

dark brown in color. It is desirable for a formulated glyphosate product to be lighter in color than the alkylpolyglycoside-containing products as disclosed in WO 00/15037, which have a color value of 14 to 18 as measured by a Gardner colorimeter. When dye is added to a formulated glyphosate product having a Gardner color greater than about 10, the concentrate remains dark brown in color. Concentrates having a Gardner color value of 10 are difficult to dye blue or green as is often desired to distinguish the glyphosate product from other herbicidal products.

It would be desirable to provide a storage-stable aqueous concentrate composition (i.e. formulation) of the potassium salt of glyphosate, or other glyphosate salts other than IPA glyphosate, having an agriculturally useful surfactant content, or that is "fully loaded" with surfactant. These formulations exhibit a reduced viscosity such that they may be pumped with standard bulk pumping equipment at 0°C at rates of at least 7.5 gallons per minute, usually more than 10 gallons per minute and preferably greater than 12.5 gallons per minute. An "agriculturally useful surfactant content" means containing one or more surfactants of such a type or types and in such an amount that a benefit is realized by the user of the composition in terms of herbicidal effectiveness by comparison with an otherwise similar composition containing no surfactant. By "fully loaded" is meant having a sufficient concentration of a suitable surfactant to provide, upon conventional dilution in water and application to foliage, herbicidal effectiveness on one or more important weed species without the need for further surfactant to be added to the diluted composition.

By "storage-stable," in the context of an aqueous concentrate composition of glyphosate salt further containing a surfactant, is meant not exhibiting phase separation on exposure to temperatures up to about 50°C for 14-28 days, and preferably not forming crystals of glyphosate or salt thereof on exposure to a temperature of about 0°C for a period of up to about 7 days (i.e., the composition must have a crystallization point of 0°C or lower). For aqueous solution concentrates, high temperature storage stability is often indicated by a cloud point of about 50°C or more. Cloud point of a composition is normally determined by heating the composition until the solution becomes cloudy, and then allowing the composition to cool, with agitation, while its temperature is continuously monitored. A temperature reading taken when the solution clears is a measure of cloud point. A cloud point of 50°C or more is normally considered acceptable for most commercial purposes for a glyphosate SL formulation. Ideally the cloud

64725-903 (D)

8

point should be 60°C or more, and the composition should withstand temperatures as low as about -10°C for up to about 7 days without crystal growth, even in the presence of seed crystals of the glyphosate salt.

A surfactant that is described herein as "compatible" with a glyphosate salt at specified surfactant and glyphosate a.e. concentrations is one that provides a storage-stable aqueous concentrate as defined immediately above containing that surfactant and salt at the specified concentrations.

Users of liquid herbicidal products typically meter the dosage by volume rather than by weight, and such products are usually labeled with directions for suitable use rates expressed in volume per unit area, e.g., liters per hectare (l/ha) or fluid ounces per acre (oz/acre). Thus the concentration of herbicidal active ingredient that matters to the user is not percent by weight, but weight per unit volume, e.g., grams per liter (g/l) or pounds per gallon (lb/gal). In the case of glyphosate salts, concentration is often expressed as grams of acid equivalent per liter (g a.e./l).

Historically, surfactant-containing glyphosate IPA salt products such as Roundup® and Roundup® Ultra herbicides of Monsanto Company have most commonly been formulated at a glyphosate concentration of about 360 g a.e./l. The surfactant-containing glyphosate TMS salt product Touchdown® of Zeneca has been formulated at a glyphosate concentration of about 330 g a.e./l. Products at lower a.e. concentration, i.e., more dilute, are also sold in some markets, but carry a cost penalty per unit of glyphosate they contain, primarily reflecting packaging, shipping and warehousing costs.

Further benefits in cost savings and in convenience to the user are possible if a "fully loaded" aqueous concentrate composition, or at least one having an agriculturally useful surfactant content, can be provided at a glyphosate concentration of at least about 320 g a.e./l, 340 g a.e./l, or significantly more than 360 g a.e./l, for example at least about 420 g a.e./l or more, or at least 440, 450, 460, 470, 480, 490, 500, 510, 520, 530, 540, 550 or 600 g a.e./l or more.

At very high glyphosate a.e. concentrations such as these, a significant problem normally occurs. This is the difficulty in pouring and/or pumping of the aqueous concentrate arising from the high viscosity of the concentrate, especially as manifested at low temperatures. It would therefore be highly desirable to have a highly concentrated aqueous solution of glyphosate potassium salt fully loaded with an agriculturally useful surfactant, such formulation preferably being less

viscous than glyphosate potassium salt formulations containing alkylpolyglycoside surfactants, such as those disclosed in PCT Publication No. WO 00/15037.

5 There is a continuing need for surfactants which are compatible with a pesticidal formulation, such as an aqueous glyphosate herbicidal concentrate. The surfactants of the invention include novel surfactants as well as known surfactants not previously used in pesticidal formulations. Surfactants that are particularly compatible with potassium glyphosate or other glyphosate salts
10 other than IPA glyphosate have been identified for formulating concentrates having improved viscosity, storage stability and loading as compared to known glyphosate concentrates.

As will be clear from the disclosure that follows, these and other benefits are provided by the present invention.

15

SUMMARY OF THE INVENTION

The present invention provides novel surfactants for formulating pesticide compositions such as aqueous herbicidal concentrates containing glyphosate or a salt or ester thereof. It has also been discovered that certain
20 surfactants previously unknown for use in agriculture enhance herbicidal efficacy while remaining compatible with the glyphosate after prolonged storage.

In accordance with an embodiment of the present invention there is provided a pesticidal composition comprising (i) glyphosate or a salt or ester thereof, and (ii) an
25 agriculturally useful amount of at least one surfactant compound selected from the group consisting of: (a) monoalkoxylated amines having the formula:

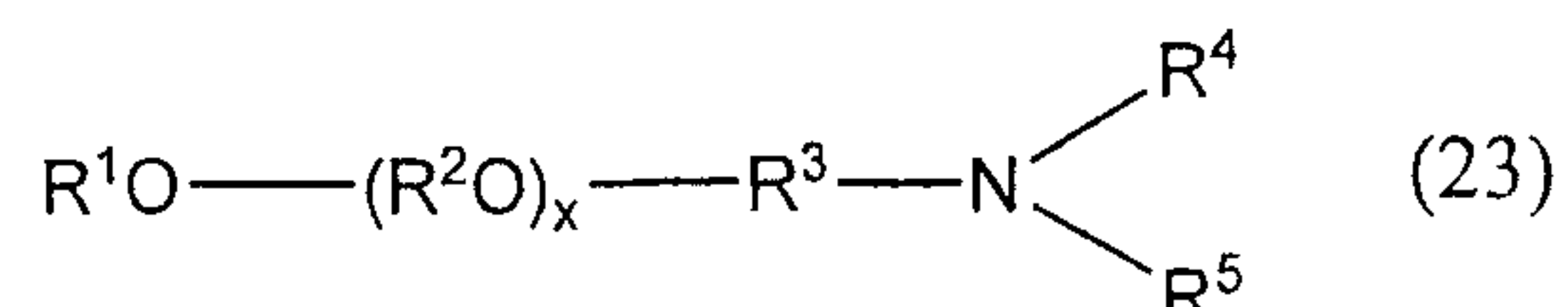

30 wherein R^1 is hydrocarbyl having at least 7 carbon atoms; R^2 in each of the $(R^2O)_x$ groups is independently C_2-C_4 alkylene; R^3 is ethylene or propylene; R^4

9a

and R^5 are each independently hydrogen or hydrocarbyl having from 1 to 6 carbon atoms, and x is an average number from 1 to 20; (b) di-poly (hydroxyalkyl)amines having the formula:

5

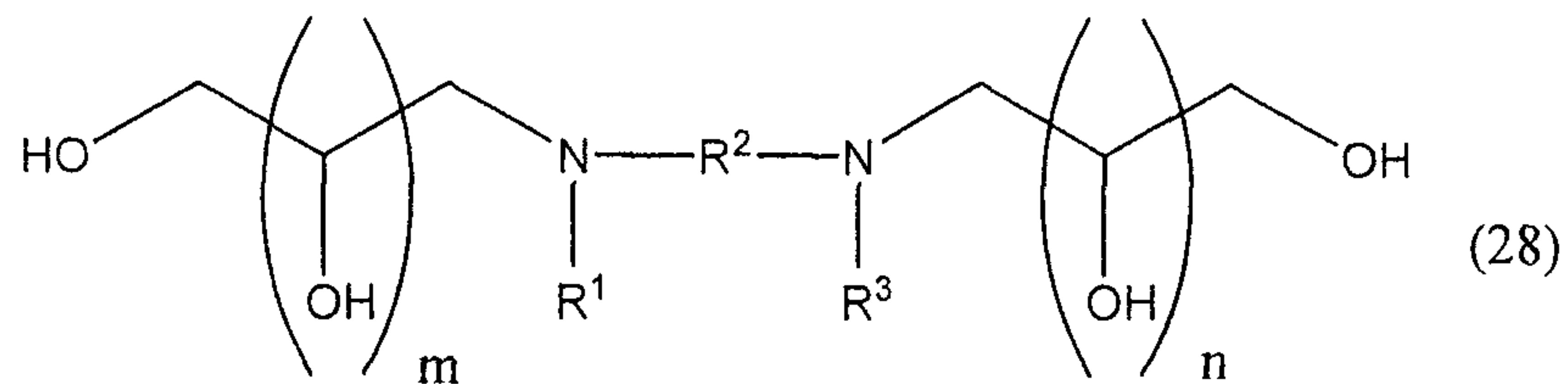

wherein R^1 and R^3 are hydrocarbyl having from 1 to 22 carbon atoms, R^2 is hydrocarbylene having from 2 to 18 carbon atoms, and m and n are independently integers from 1 to 8; and (c) alkoxyated triamines having the formula:

10

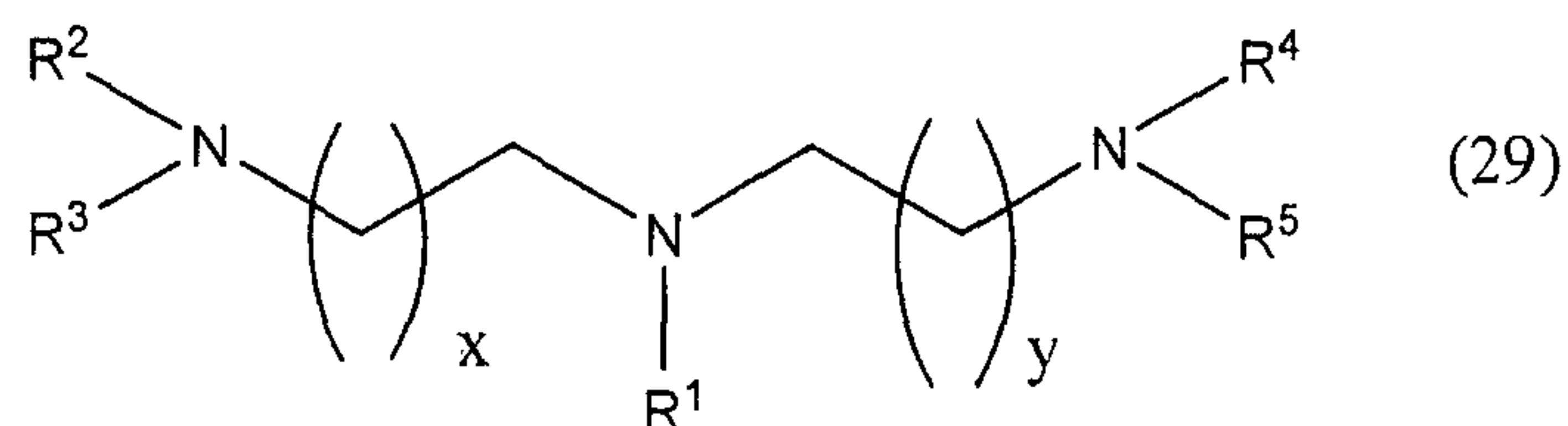

15

wherein R^1 is hydrocarbyl having from 8 to 18 carbon atoms; R^2 , R^3 , R^4 and R^5 are hydrogen hydrocarbyl having from 1 to 6 carbon atoms; and x and y are independently 1 to 4.

20

An aqueous herbicidal concentrate composition is disclosed comprising glyphosate, predominantly in the form of the potassium salt thereof, in solution in an amount of in excess of 300 grams acid equivalent per liter of the composition, and a surfactant component in solution or stable suspension, emulsion or dispersion, comprising one or more surfactants in a total amount of about 20 to about 300 grams per liter of the composition. The composition either (a) has a viscosity of less than about 250 centipoise at 0°C at 45/s shear rate, (b) has a Gardner color value of not more than 14 when free of dye or a

25

9b

coloring agent, (c) has a viscosity less than a similarly loaded glyphosate potassium salt composition comprising an alkylpolyglycoside surfactant in combination with an alkoxyated alkylamine surfactant, said alkylpolyglycoside and alkylamine surfactants being present in a weight ratio between about 5:1
5 and 1:1, (d) controls velvetleaf growth as compared to such a similarly loaded glyphosate potassium salt composition, (e) contains a surfactant component that includes no effective amount of an alkylpolyglycoside and is selected such that the composition remains substantially homogeneous when stored at 50°C
10 for about 14 to 28 days, or (f) includes a surfactant component that contains an

15

20

25

30

effective amount of alkylpolyglycoside in combination with at least one additional surfactant that contains no effective amount of an alkoxyated alkylamine.

5 Such a glyphosate concentrate having a viscosity of less than about 250 centipoise at 0°C at 45/s shear rate, in which the surfactant component comprises one or more amine or quaternary ammonium salt compounds is also disclosed. Each of the
10 compounds includes an alkyl or aryl substituent having from about 4 to about 16 carbon atoms and not more than ten ethylene oxide linkages within the compound. The compounds are present in an amount which enhances the compatibility of the surfactant component with the glyphosate salt.

 The invention is also directed to formulations
15 which form anisotropic aggregates comprised of a surfactant on the waxy cuticle of the foliage of the plant upon which the formulation is applied. Other herbicidal formulations of the present invention form liquid crystals comprised of the surfactant on the waxy cuticle of the foliage of the
20 plant upon which the formulation is applied. Still other herbicidal formulations of the present invention form liquid crystals comprised of the surfactant on the waxy cuticle of the foliage and inside the plant upon which the formulation is applied. It has been found that the formation of
25 anisotropic aggregates and both epicuticular and intracuticular liquid crystals do not depend on the presence or absence of a second surfactant and significantly enhance the performance of the herbicidal formulations of the present invention.

30 According to one aspect of the invention of the parent application, there is provided a formulation useful

64725-903 (D)

10a

in retarding the growth of vegetation comprising an aqueous mixture containing a surfactant and glyphosate or a salt or ester thereof, the nature of said surfactant and the composition of said formulation being such that, upon
5 application of the formulation to a plant, liquid crystals comprising said surfactant are formed on the foliage of the plant.

According to another aspect of the invention of the parent application, there is provided a storage-stable
10 herbicidal concentrate which may be diluted with water to provide an aqueous herbicidal application mixture for application to the foliage of a plant, said concentrate comprising glyphosate or a salt or ester thereof in a concentration of at least about 500 g a.e./l glyphosate acid
15 equivalent, and a surfactant component, the nature and concentration of said surfactant component in said concentrate being such that, upon applying said application mixture to the foliage of a plant, anisotropic aggregates comprising said surfactant are formed on said plant foliage.

20 According to still another aspect of the invention of the parent application, there is provided a formulation useful in retarding the growth of vegetation comprising an aqueous mixture containing a surfactant and glyphosate or a salt or ester thereof, the nature of said surfactant and the
25 composition of said formulation being such that, upon application of the formulation to a plant, anisotropic aggregates comprising said surfactant are formed within the cuticles of the plant foliage.

According to yet another aspect of the invention
30 of the parent application, there is provided a storage-stable herbicidal concentrate which may be diluted with water to provide an aqueous herbicidal application mixture

64725-903 (D)

10b

for application to the foliage of a plant, said concentrate comprising glyphosate or a salt or ester thereof in a concentration of at least about 350 g/l glyphosate acid equivalent, and a surfactant component, the nature and concentration of said surfactant component in said concentrate being such that, upon applying said application mixture to the foliage of a plant, anisotropic aggregates comprising said surfactant are formed within the cuticles of the plant foliage.

10 According to a further aspect of the invention of the parent application, there is provided a storage-stable herbicidal concentrate which may be diluted with water to provide an aqueous herbicidal application mixture for application to the foliage of a plant, said concentrate
15 comprising a potassium, monoammonium, diammonium, sodium, monoethanolamine, n-propylamine, ethylamine, ethylenediamine, hexamethylenediamine, or trimethylsulfonium salt of glyphosate and having a glyphosate acid equivalent concentration of at least 270 grams per liter, the nature of
20 said surfactant and the composition of said concentrate being such that, upon application to a plant of the concentrate or said application mixture, anisotropic aggregates comprising said surfactant are formed on said plant foliage.

25 According to yet a further aspect of the invention of the parent application, there is provided a formulation useful in retarding the growth of vegetation comprising an aqueous mixture containing a surfactant, glyphosate or a salt or ester thereof, and a dicarboxylic acid, the nature
30 of said surfactant and the composition of said formulation being such that, upon application of the formulation to a plant, anisotropic aggregates comprising said surfactant are formed on the foliage of said plant.

64725-903 (D)

10c

According to still a further aspect of the invention of the parent application, there is provided a formulation useful in retarding the growth of vegetation comprising an aqueous mixture containing a surfactant and
5 glyphosate or a salt or ester thereof, said aqueous mixture having a specific gravity of at least about 1.210 grams/liter, the nature of said surfactant and the composition of said formulation being such that, upon
10 application of the formulation to a plant, anisotropic aggregates comprising said surfactant are formed on or in the foliage of said plant.

According to another aspect of the invention of the parent application, there is provided an aqueous herbicidal concentrate formulation comprising (a)
15 glyphosate, predominantly in the form of the potassium salt thereof, in solution in an amount of in excess of 300 grams acid equivalent per liter of the formulation; and (b) a surfactant component in solution or stable suspension, emulsion or dispersion, comprising one or more surfactants
20 in a total amount of about 20 to about 300 grams per liter of the formulation; wherein the formulation has a viscosity of less than about 250 centipoise at 0°C at 45/s shear rate.

According to yet another aspect of the invention of the parent application, there is provided an aqueous
25 herbicidal concentrate formulation comprising (a) glyphosate, predominantly in the form of the potassium salt thereof, in solution in an amount of in excess of 300 grams acid equivalent per liter of the formulation; and (b) a surfactant component in solution or stable suspension,
30 emulsion or dispersion, comprising one or more surfactants in a total amount of about 20 to about 300 grams per liter of the formulation; wherein the formulation when free of dye

64725-903(D)

10d

or a coloring agent has a Gardner color value of not more than 14.

According to another aspect of the invention of the parent application, there is provided an aqueous
5 herbicidal concentrate formulation comprising (a) glyphosate, predominantly in the form of the potassium salt thereof, in solution in an amount of in excess of 300 grams acid equivalent per liter of the formulation; and (b) a surfactant component in solution or stable suspension,
10 emulsion or dispersion, comprising one or more surfactants in a total amount of about 20 to about 300 grams per liter of the formulation; wherein the formulation has a viscosity less than a similarly loaded glyphosate potassium salt formulation comprising an alkylpolyglycoside surfactant in
15 combination with an alkoxylated alkylamine surfactant, said alkylpolyglycoside and alkylamine surfactants being present in a weight ratio between about 5:1 and 1:1.

According to still another aspect of the invention of the parent application, there is provided an aqueous
20 herbicidal concentrate composition comprising (a) glyphosate, predominantly in the form of the potassium salt thereof, in solution in said water in an amount of in excess of 300 grams acid equivalent per liter of the composition; and (b) a surfactant component in solution or stable
25 suspension, emulsion or dispersion in said water, comprising one or more surfactants in a total amount of about 20 to about 300 grams per liter of the composition; wherein said surfactant component contains no effective amount of an alkylpolyglycoside and is selected such that the composition
30 remains substantially homogeneous when stored at 50°C for about 14 to 28 days.

64725-903(D)

10e

According to yet another aspect of the invention of the parent application, there is provided an aqueous herbicidal concentrate composition comprising (a) glyphosate, predominantly in the form of the potassium salt thereof, in solution in said water in an amount of in excess of 300 grams acid equivalent per liter of the composition; and (b) a surfactant component in solution or stable suspension, emulsion or dispersion in said water, comprising one or more surfactants in a total amount of about 20 to about 300 grams per liter of the composition; wherein said surfactant component contains an effective amount of alkylpolyglycoside in combination with at least one additional surfactant that contains no effective amount of an alkoxyated alkylamine.

According to a further aspect of the invention of the parent application, there is provided an aqueous herbicidal concentrate formulation comprising (a) glyphosate, predominantly in the form of the potassium salt thereof, in solution in said water in an amount of in excess of 300 grams acid equivalent per liter of the formulation; and (b) a surfactant component in solution or stable suspension, emulsion or dispersion in said water, comprising one or more surfactants in a total amount of about 20 to about 300 grams per liter of the formulation; wherein the formulation controls velvetleaf growth to a greater extent than a similarly loaded glyphosate potassium salt formulation comprising an alkylpolyglycoside surfactant in combination with an alkoxyated alkylamine surfactant in a weight ratio of alkylpolyglycoside to alkylamine surfactant of between about 5:1 and 1:1.

According to yet a further aspect of the invention of the parent application, there is provided an aqueous herbicidal concentrate formulation comprising (a)

64725-903(D)

10f

glyphosate, predominantly in the form of the potassium salt thereof, in solution in said water in an amount in excess of 300 grams acid equivalent per liter of the formulation; and (b) a surfactant component in solution or stable suspension, emulsion or dispersion in said water, comprising one or more surfactants in a total amount of about 20 to about 300 grams per liter of the formulation; wherein the formulation has a viscosity of less than about 250 centipoise at 0°C at 45/s shear rate, and said surfactant component comprises one or more amine or quaternary ammonium salt compounds, each of which comprises an alkyl or aryl substituent having from about 4 to about 16 carbon atoms and not more than ten ethylene oxide linkages within the compound, said compounds being present in an amount which enhances the compatibility of said surfactant component with said glyphosate salt.

According to still a further aspect of the invention of the parent application, there is provided an aqueous herbicidal concentrate composition comprising (a) glyphosate, or a salt or ester thereof, in solution in said water in an amount in excess of 300 grams acid equivalent per liter of the composition; and (b) a surfactant component in solution or stable suspension, emulsion or dispersion in said water, comprising one or more surfactants in a total amount of about 20 to about 300 grams per liter of the composition; wherein said surfactant component comprises one or more amine or quaternary ammonium salt compounds, each of which comprises an alkyl or aryl substituent having from about 4 to about 16 carbon atoms and not more than ten ethylene oxide linkages within the compound, said compounds being present in an amount which enhances the compatibility of said surfactant component with the glyphosate.

According to another aspect of the invention of the parent application, there is provided a pesticidal

64725-903(D)

10g

composition comprising (i) glyphosate or a salt or ester thereof; and (ii) an agriculturally useful amount of at least one surfactant compound selected from the group consisting of: (a) monoalkoxylated amines having the
5 formula:

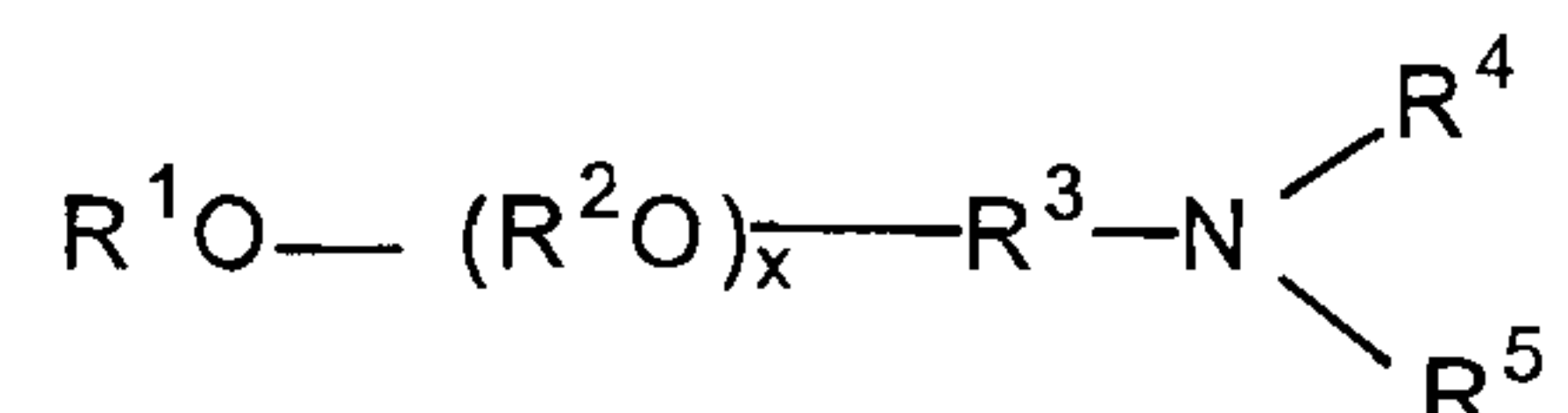

(23)

10 wherein R^1 is hydrogen or hydrocarbyl or substituted hydrocarbyl having at least 7 carbon atoms; R^2 in each of the x (R^2O) and y (R^2O) groups is independently C_2-C_4 alkylene; R^3 is a hydrocarbylene or substituted hydrocarbylene having from 2 to about 6 carbon atoms; R^4 and R^5 are each
15 independently hydrogen, hydrocarbyl or substituted hydrocarbyl having from 1 to about 30 carbon atoms, $-(R^6)_n-$ $(R^2O)_yR^7$, or R^4 and R^5 , together with the nitrogen atom to which they are attached, form a cyclic or heterocyclic ring; R^6 is hydrocarbylene or substituted hydrocarbylene containing
20 from 1 to about 6 carbon atoms, R^7 is hydrogen or a linear or branched alkyl group having 1 to about 4 carbon atoms, n is 0 or 1, and x and y are independently an average number from 1 to about 60, provided, however, that when R^2 and R^3 in each of the x (R^2O) groups is ethylene, R^1 is other than
25 unsubstituted alkyl or R^4 is other than hydrogen or unsubstituted alkyl when R^5 is hydrogen or unsubstituted alkyl, and when R^2 and R^3 are isopropylene and x is 1, R^1 is other than unsubstituted alkyl or R^4 is other than $-(R^2O)_yR^7$;
(b) alkoxyated poly(hydroxyalkyl)amines having the

64725-903 (D)

10h

formula:

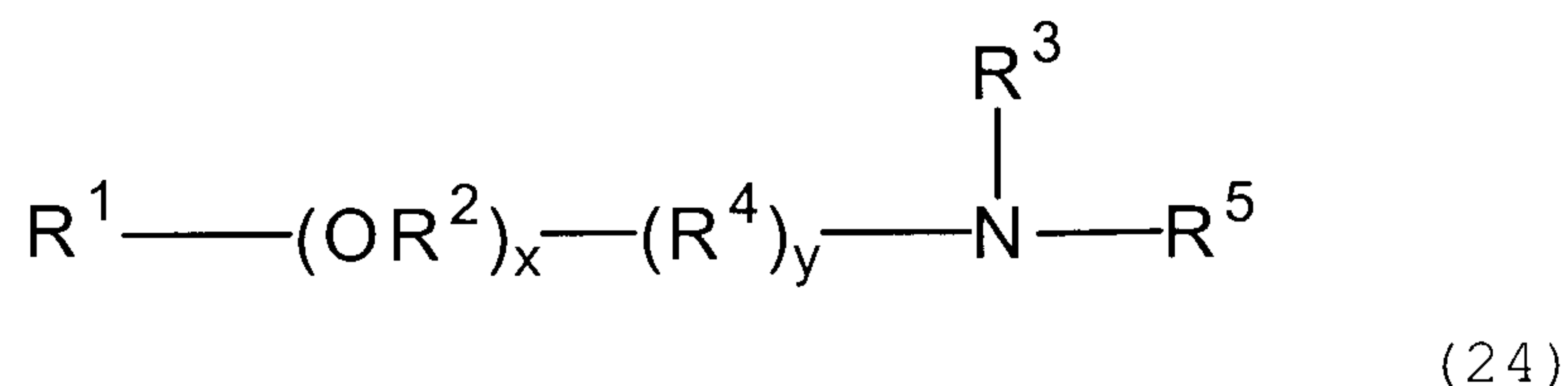

5 wherein R^1 and R^3 are independently hydrogen, hydrocarbyl or substituted hydrocarbyl having from 1 to about 30 carbon atoms, R^2 in each of the x (R^2O) groups is independently C_2-C_4 alkylene; R^4 is hydrocarbylene or substituted hydrocarbylene having from 1 to about 30 carbon atoms, R^5 is hydroxyalkyl, polyhydroxyalkyl, or poly(hydroxyalkyl)alkyl; x is an average number from 0 to about 30, and y is 0 or 1; (c) di-

10 poly(hydroxyalkyl)amines having the formula:

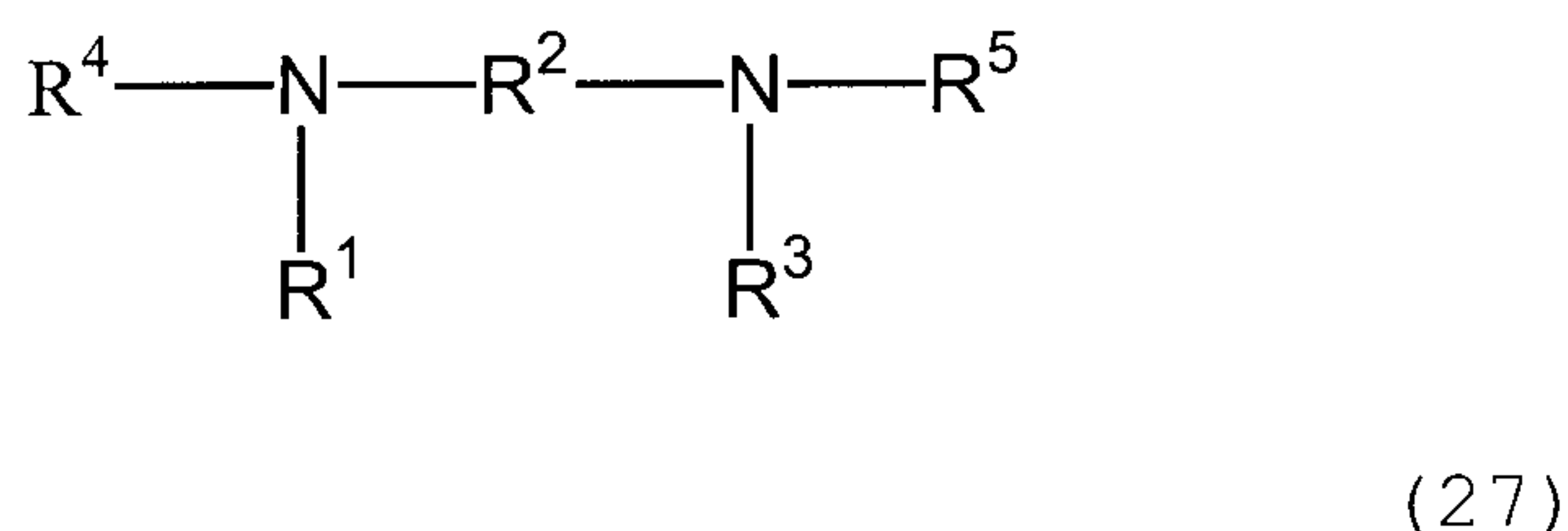

15 wherein R^1 and R^3 are independently hydrogen or hydrocarbyl or substituted hydrocarbyl having from 1 to about 22 carbon atoms, R^2 is hydrocarbylene or substituted hydrocarbylene having from 2 to about 18 carbon atoms, R^4 and R^5 are independently hydroxyalkyl, polyhydroxyalkyl, or

20 poly(hydroxyalkyl)alkyl, provided, however, that when R^1 and R^3 are methyl, R^2 is other than octylene; (d) alkoxyated triamines having the formula:

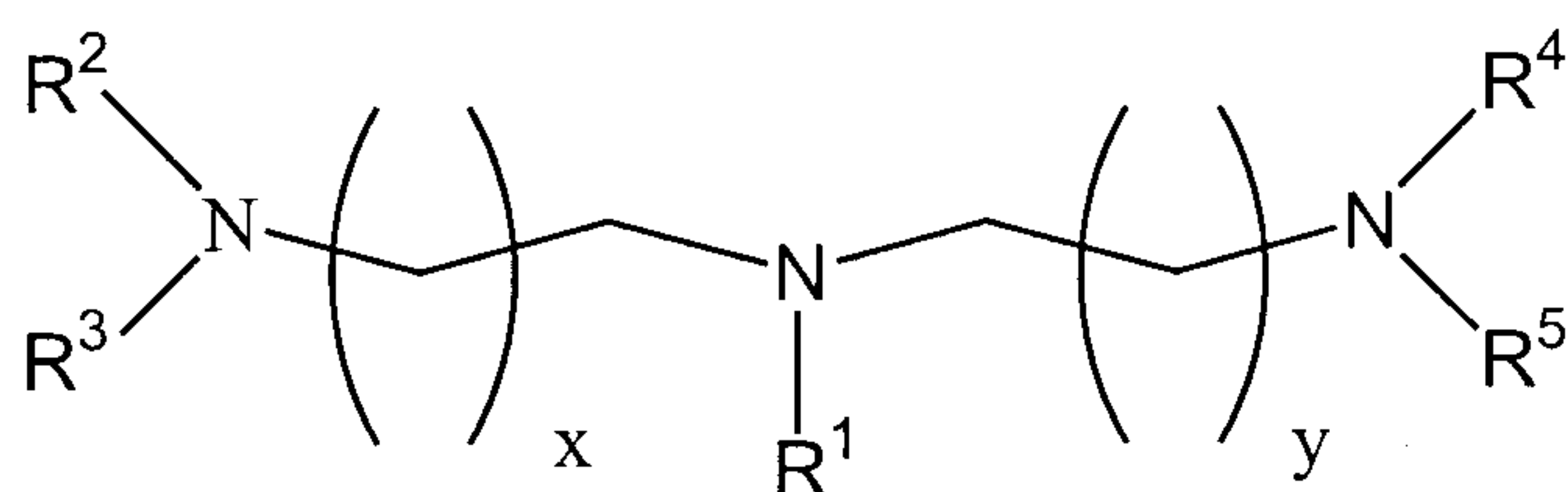

25

(29)

64725-903(D)

10i

wherein R^1 is hydrocarbyl or substituted hydrocarbyl having from 1 to about 30 carbon atoms; R^2 , R^3 , R^4 and R^5 are independently hydrogen, hydrocarbyl or substituted hydrocarbyl having from 1 to about 30 carbon atoms, or $-(R^8)_s (R^7-O)_n R^6$; R^6 is hydrogen, or a linear or branched alkyl group having from 1 to about 4 carbon atoms; R^7 in each of the n (R^7O) groups is independently C_2-C_4 alkylene; R^8 is hydrocarbylene or substituted hydrocarbylene having from 1 to about 6 carbon atoms; n is an average number from 1 to about 10; s is 0 or 1; and x and y are independently an integer from 1 to about 4; provided, however, that when R^1 is alkyl, R^2 is other than hydrogen, x is 3 or 4, or R^4 is other than $-(R^7-O)_n R^6$; (e) monoalkoxylated amines having the formula

15

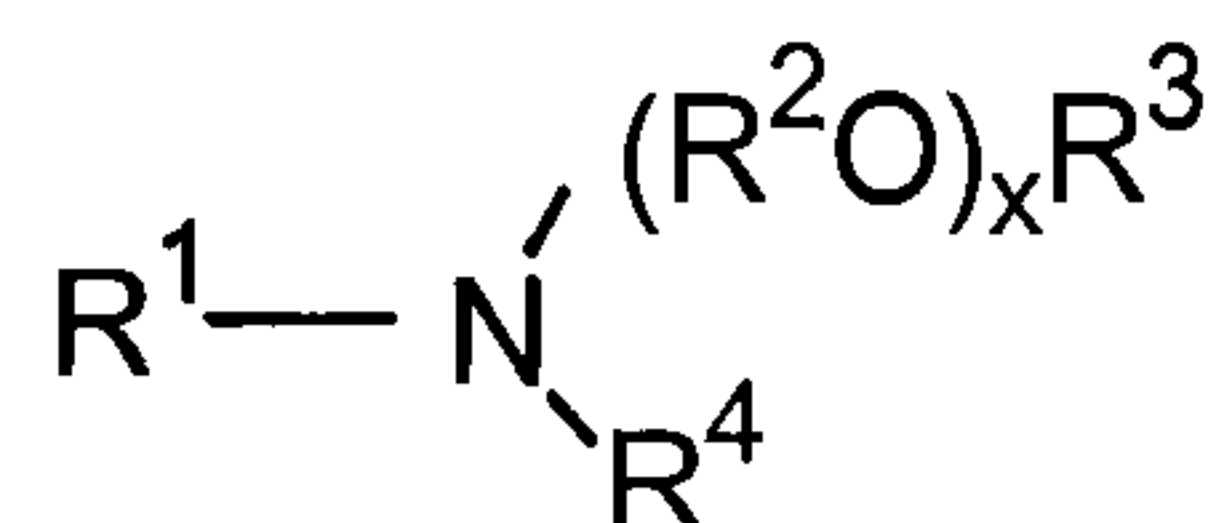

20

(30)

wherein R^1 is a hydrocarbyl or substituted hydrocarbyl group having from 1 to about 30 carbon atoms, R^2 is C_2-C_4 alkylene, R^3 is hydrogen, or a linear or branched alkyl group having from 1 to about 4 carbon atoms, R^4 is a linear or branched alkynyl, aryl, or aralkyl group having from 1 to about 30 carbon atoms, and x is an average number from 1 to about 60; (f) amine oxides having the formula:

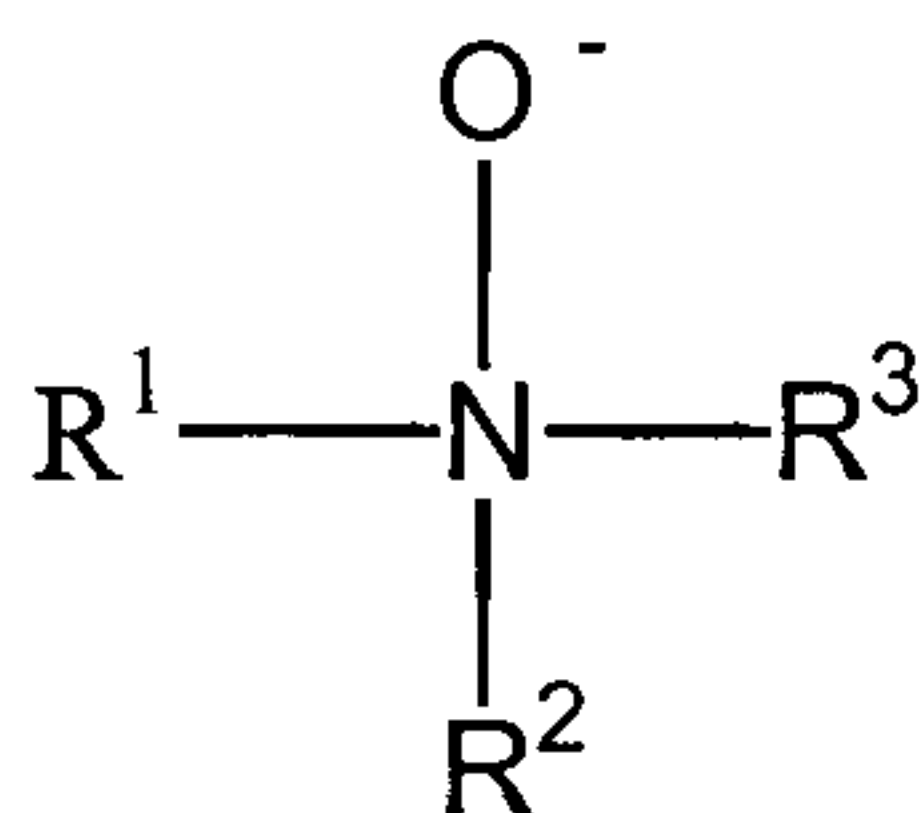

(31)

64725-903(D)

10j

wherein R^1 is hydrocarbyl or substituted hydrocarbyl having from about 8 to about 30 carbon atoms, R^2 and R^3 are independently $-(R^4O)_xR^5$, R^4 in each of the x (R^4O) groups is independently C_2-C_4 alkylene, R^5 is hydrogen, or a hydrocarbyl or substituted hydrocarbyl having from 1 to about 30 carbon atoms, x is an average number from 1 to about 50; (g) an alkoxyated amine oxide having the formula:

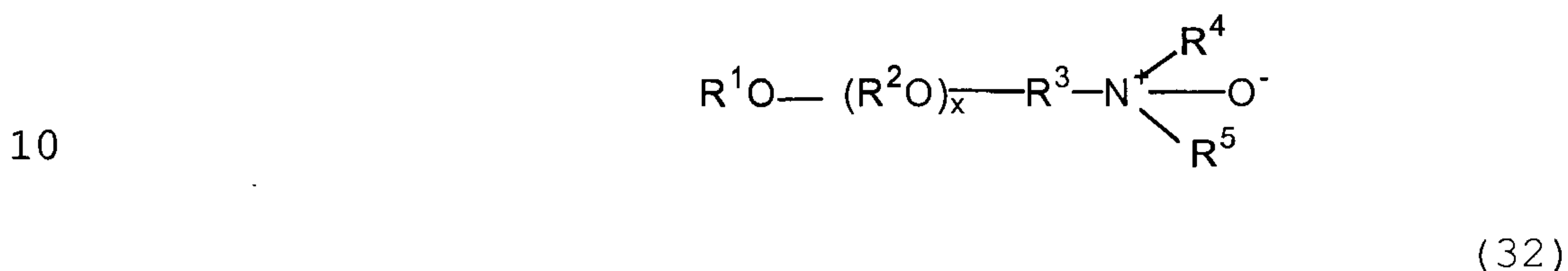

wherein R^1 is hydrogen or hydrocarbyl or substituted hydrocarbyl having from 1 to about 30 carbon atoms; R^2 in each of the x (R^2O) and y (R^2O) groups is independently C_2-C_4 alkylene; R^3 is a hydrocarbylene or substituted hydrocarbylene having from 2 to about 6 carbon atoms; R^4 and R^5 are each independently hydrogen, hydrocarbyl or substituted hydrocarbyl having from 1 to about 30 carbon atoms, $-(R^6)_n-(R^2O)_yR^7$; R^6 is hydrocarbylene or substituted hydrocarbylene containing from 1 to about 6 carbon atoms, R^7 is hydrogen or a linear or branched alkyl group having 1 to about 4 carbon atoms, n is 0 or 1, and x and y are independently an average number from 1 to about 60; (h) alkoxyated diamines having the formula:

25

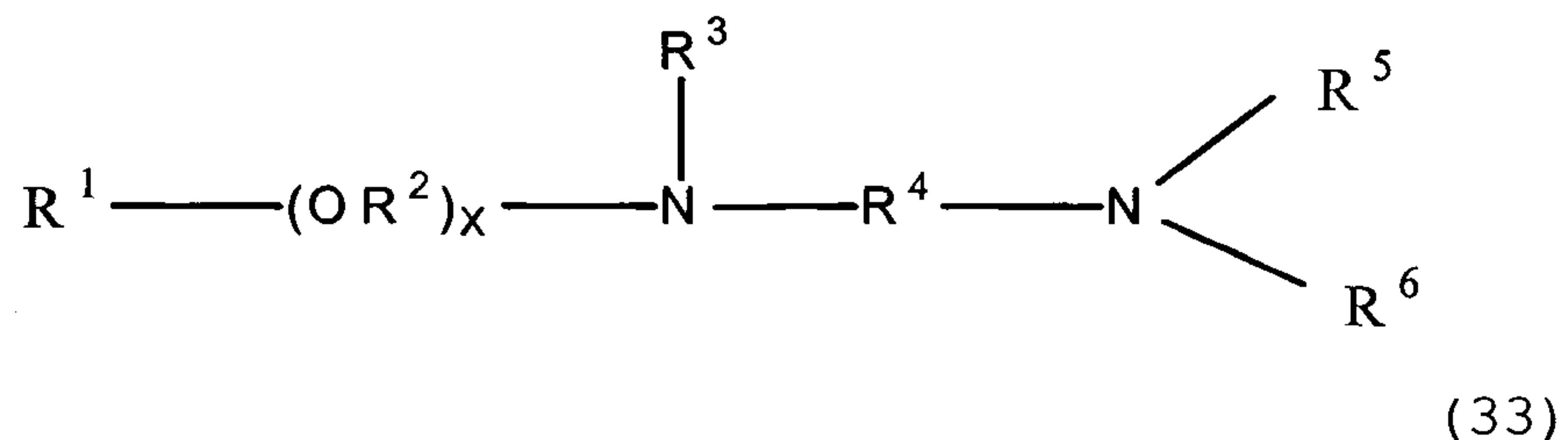

64725-903(D)

10k

wherein R^1 is hydrocarbyl or substituted hydrocarbyl having from about 8 to about 30 carbon atoms; R^2 in each of the x (R^2O) groups and the y (R^2O) groups is independently C_2-C_4 alkylene; R^3 , R^5 and R^6 are independently hydrogen, hydrocarbyl or substituted hydrocarbyl having from 1 to about 30 carbon atoms, or $-(R^2O)_yR^7$; R^4 is hydrocarbylene or substituted hydrocarbylene having from 2 to about 6 carbon atoms, $-C(=NR^{11})NR^{12}R^{13}-$, $-C(=O)NR^{12}R^{13}-$, $-C(=S)NR^{12}R^{13}-$, $-C(=NR^{12})-$, $-C(S)-$, or $-C(O)-$; R^7 is hydrogen, or a linear or branched alkyl group having from 1 to about 4 carbon atoms; R^{11} , R^{12} and R^{13} are hydrogen, hydrocarbyl or substituted hydrocarbyl having from 1 to about 30 carbon atoms x is an average number from 1 to about 30; and y is an average number from 1 to about 50, provided, however, that at least one of R^3 , R^5 and R^6 is $-(R^2O)_yR^7$, at least one R^2 is other than ethylene, R^4 is other than unsubstituted propylene, R^1 is other than unsubstituted alkyl, or x is from 2 to about 30; (i) dialkoxylated amines having the formula:

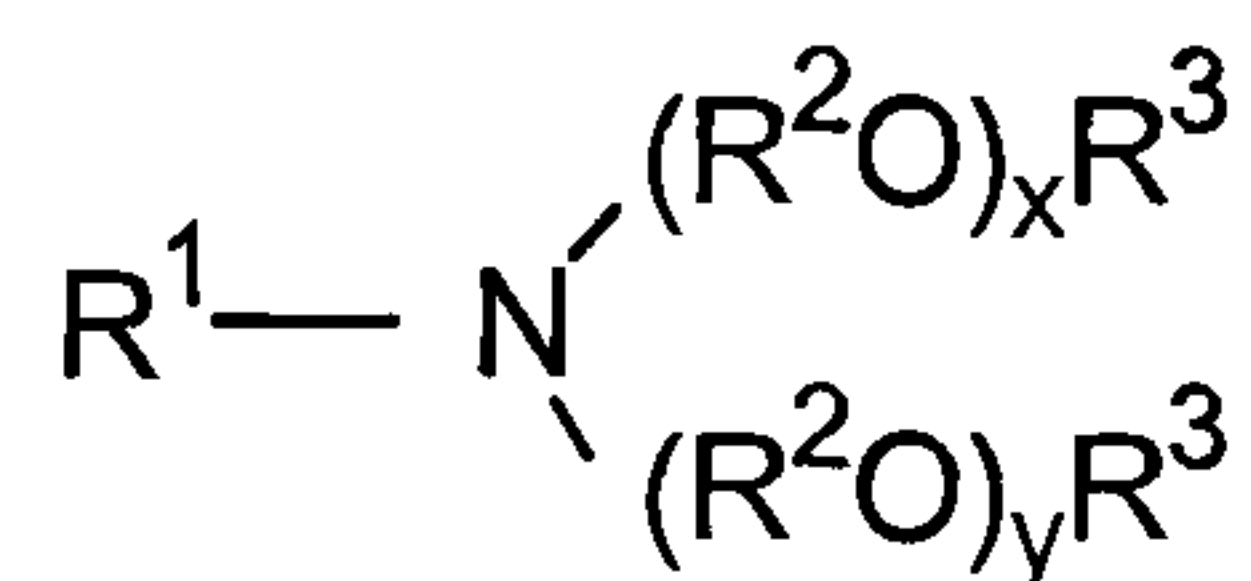

(34)

wherein R^1 is a hydrocarbyl or substituted hydrocarbyl having from about 6 to about 30 carbon atoms, or $-R^4SR^5$, R^4 and R^2 in each of the x (R^2O) and the y (R^2O) groups is independently C_2-C_4 alkylene, R^3 is hydrogen, or a linear or branched alkyl group having from 1 to about 4 carbon atoms, R^5 is a linear or branched alkyl group having from about 4 to about 15 carbon atoms, and x and y are independently an average number from 1 to about 40; (j) dialkoxylated

64725-903(D)

10m

or

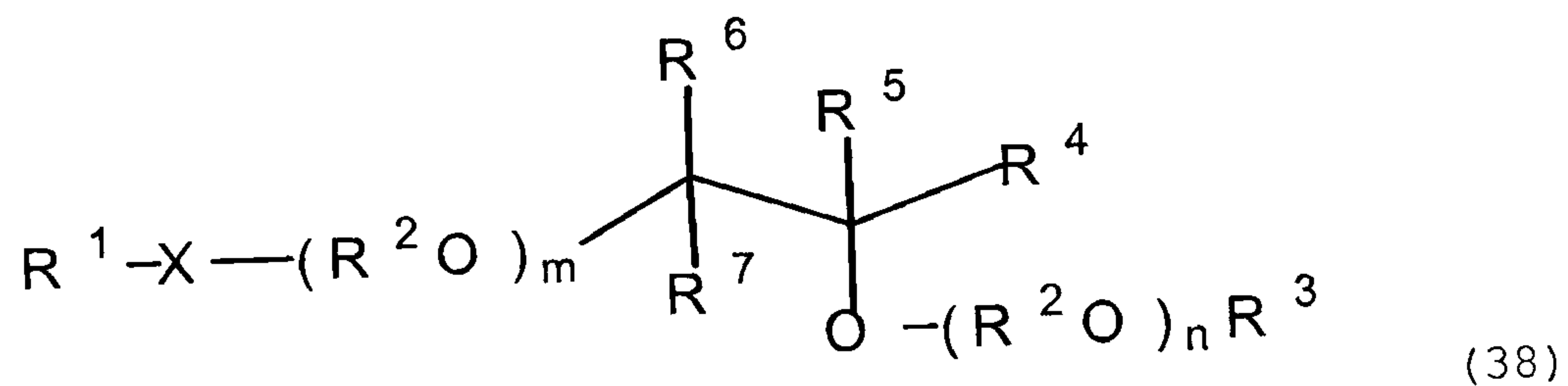

or

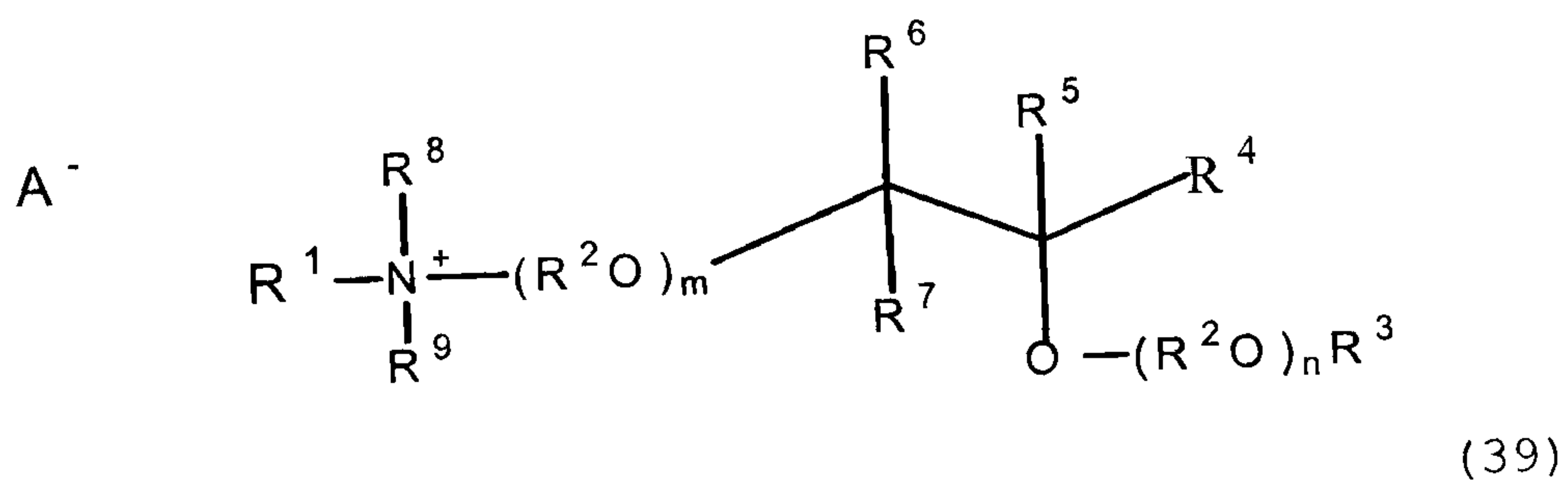

or

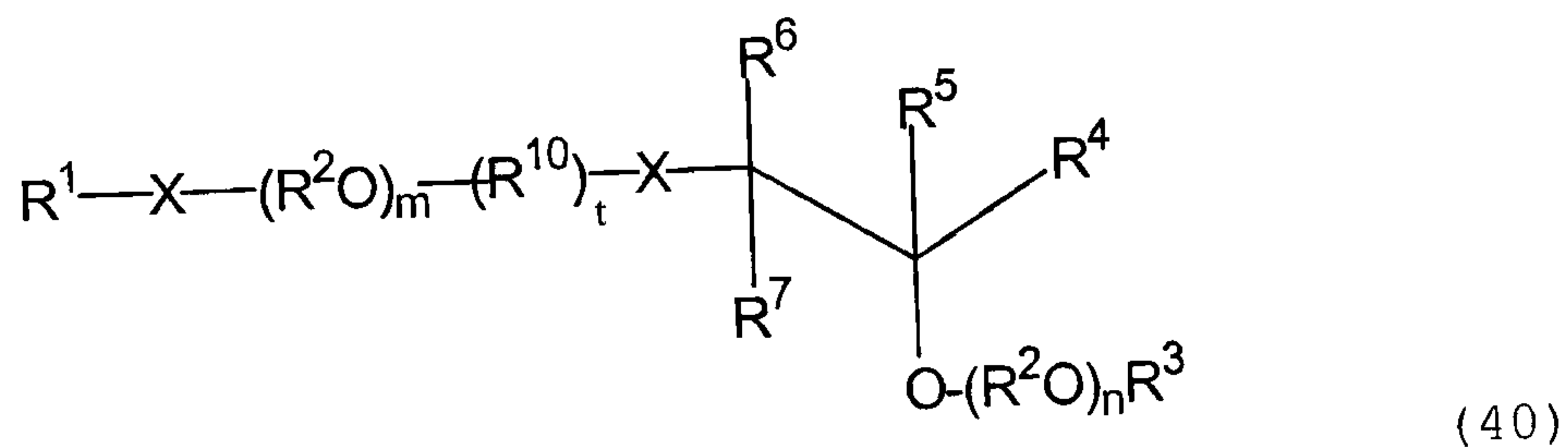

or

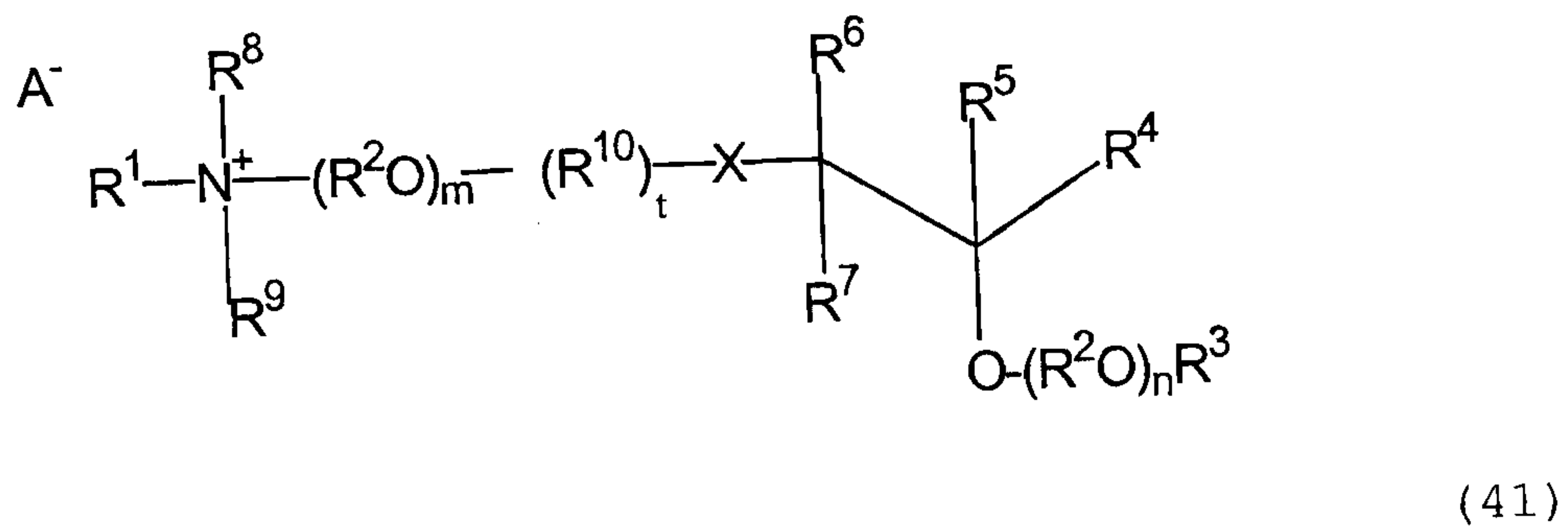

or

64725-903 (D)

10n

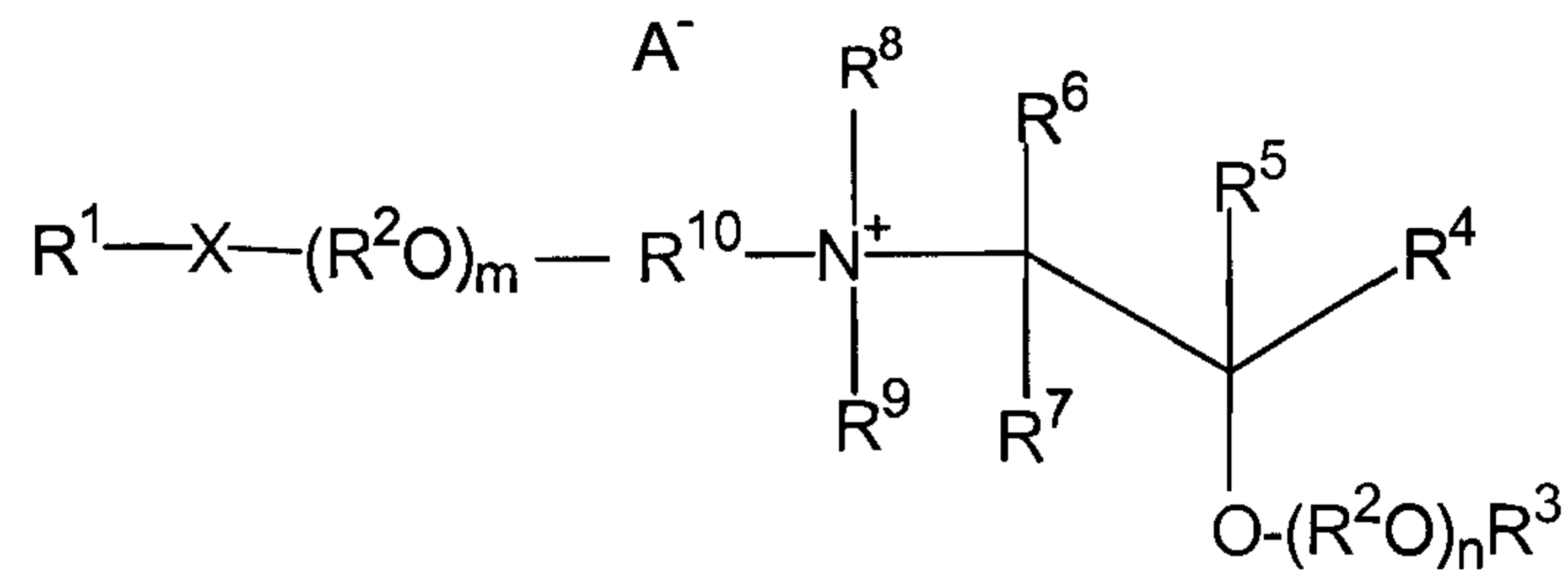

(42)

or

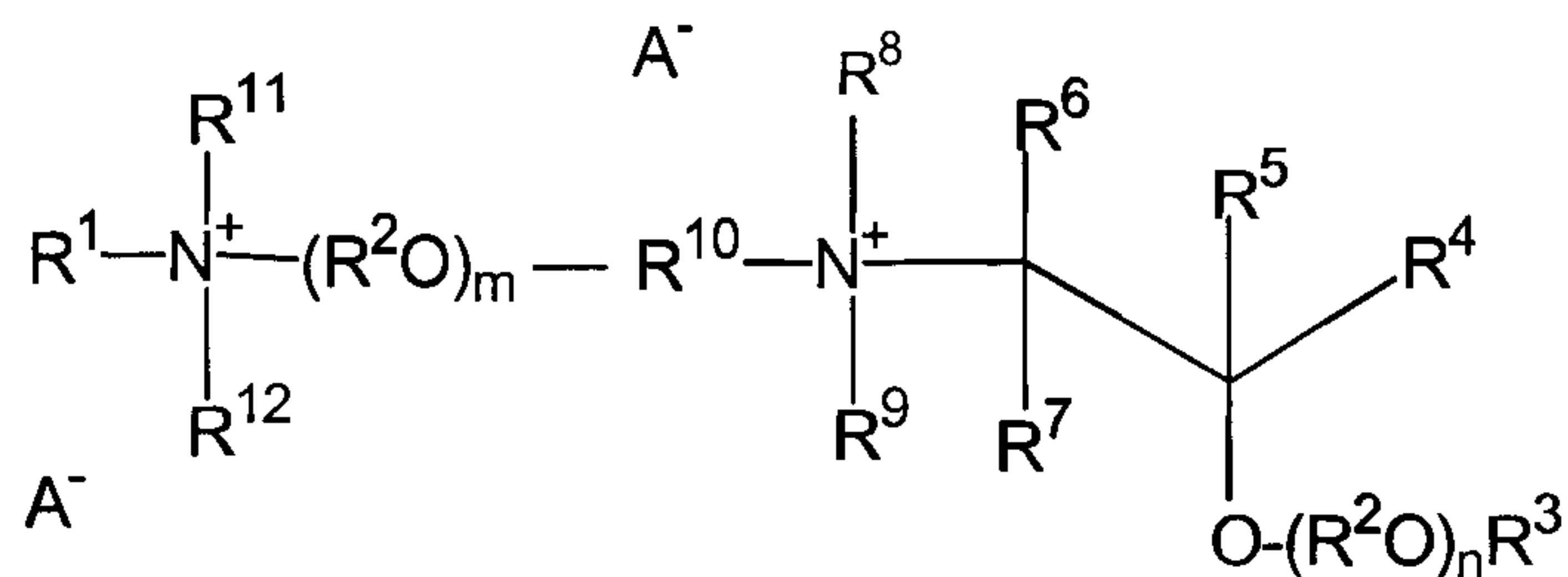

(43)

wherein R^1 , R^9 , and R^{12} are independently hydrocarbyl or substituted hydrocarbyl having from 1 to about 30 carbon atoms, or $-(\text{R}^2\text{O})_p\text{R}^{13}$; R^2 in each of the m (R^2O) , n (R^2O) , p (R^2O) and q (R^2O) groups is independently C_2 - C_4 alkylene; R^3 , R^8 , R^{11} , R^{13} and R^{15} are independently hydrogen, or a hydrocarbyl or substituted hydrocarbyl having from 1 to about 30 carbon atoms; R^4 is $-(\text{CH}_2)_y\text{OR}^{13}$ or $-(\text{CH}_2)_y\text{O}(\text{R}^2\text{O})_q\text{R}^3$; R^5 , R^6 and R^7 are independently hydrogen, hydrocarbyl or substituted hydrocarbyl having from 1 to about 30 carbon atoms, or R^4 ; R^{10} is hydrocarbylene or substituted hydrocarbylene having from 2 to about 30 carbon atoms; R^{14} is hydrocarbyl or substituted hydrocarbyl having from 1 to about 30 carbon atoms, or $-(\text{CH}_2)_z\text{O}(\text{R}^2\text{O})_p\text{R}^3$; m , n , p and q are independently an average number from 1 to about 50; X is $-\text{O}-$, $-\text{N}(\text{R}^{14})-$, $-\text{C}(\text{O})-$, $-\text{C}(\text{O})\text{O}-$, $-\text{OC}(\text{O})-$, $-\text{N}(\text{R}^{15})\text{C}(\text{O})-$, $-\text{C}(\text{O})\text{N}(\text{R}^{15})-$, $-\text{S}-$, $-\text{SO}-$, or $-\text{SO}_2-$; t is 0 or 1; A^- is an

64725-903(D)

100

agriculturally acceptable anion; and y and z are independently an integer from 0 to about 30.

According to yet another aspect of the invention of the parent application, there is provided a pesticidal composition comprising: (i) glyphosate or a salt or ester thereof; and (ii) an agriculturally useful amount of at least one surfactant selected from the group consisting of: (a) aminated alkoxyated alcohol having the formula:

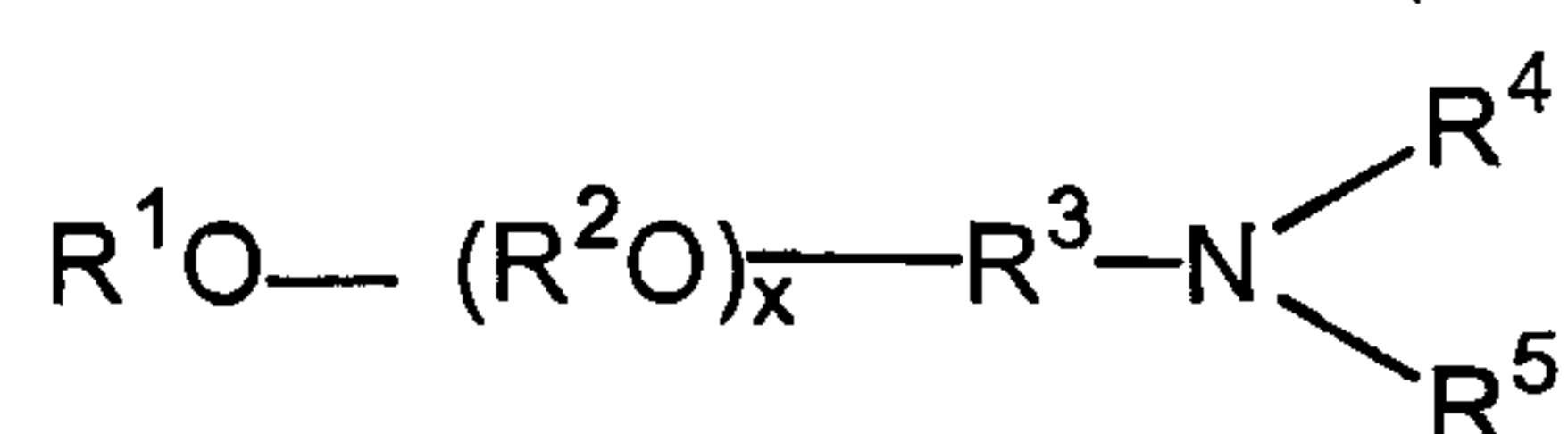

(44)

or

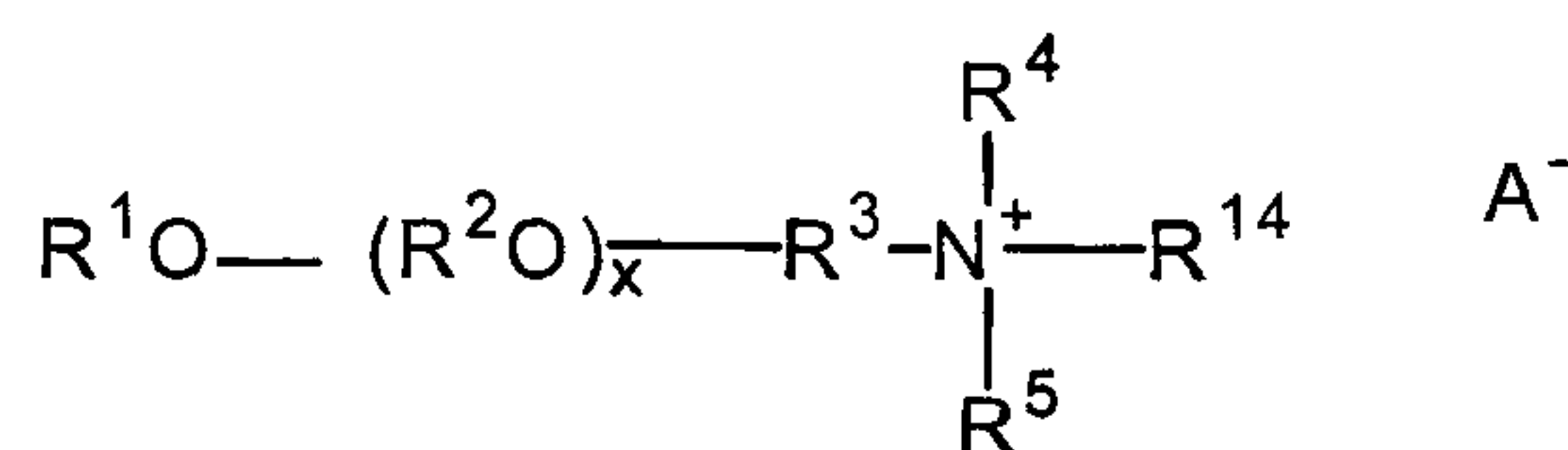

15

(45)

wherein R¹ is hydrocarbyl or substituted hydrocarbyl containing at least 7 carbon atoms; R² in each of the x (R²O) and y (R²O) groups is independently C₂-C₄ alkylene; R³ and R⁶ are each independently hydrocarbylene or substituted hydrocarbylene having from 1 to about 6 carbon atoms; R⁴ is hydrogen, hydrocarbyl or substituted hydrocarbyl having from 1 to about 30 carbon atoms, hydroxy substituted hydrocarbyl, -(R⁶)_n-(R²O)_yR⁷, -C(=NR¹¹)NR¹²R¹³, -C(=O)NR¹²R¹³, -C(=S)NR¹²R¹³ or together with R⁵ and the nitrogen atom to which they are attached, form a cyclic or heterocyclic ring; R⁵ is hydrogen, hydrocarbyl or substituted hydrocarbyl having from 1 to about 30 carbon atoms, hydroxy substituted hydrocarbyl, -(R⁶)_n-(R²O)_yR⁷, -C(=NR¹¹)NR¹²R¹³, -C(=O)NR¹²R¹³, -C(=S)NR¹²R¹³, or

64725-903(D)

10p

together with R^4 and the nitrogen atom to which they are attached, form a cyclic or heterocyclic ring; R^7 is hydrogen or a linear or branched alkyl group having 1 to about 4 carbon atoms; R^{11} , R^{12} and R^{13} are hydrogen, hydrocarbyl or substituted hydrocarbyl, R^{14} is hydrogen, hydrocarbyl or substituted hydrocarbyl having from 1 to about 30 carbon atoms, hydroxy substituted hydrocarbyl, $-(R^6)_n-(R^2O)_yR^7$, $-C(=NR^{11})NR^{12}R^{13}$, $-C(=O)NR^{12}R^{13}$, or $-C(=S)NR^{12}R^{13}$, n is 0 or 1, x and y are independently an average number from 1 to about 60, and A^- is an agriculturally acceptable anion, provided, however, that when R^2 and R^3 are isopropylene and x is 1, R^1 is other than alkyl or R^4 is other than $-(R^2O)_yR^7$; (b) hydroxylated amines having the formula:

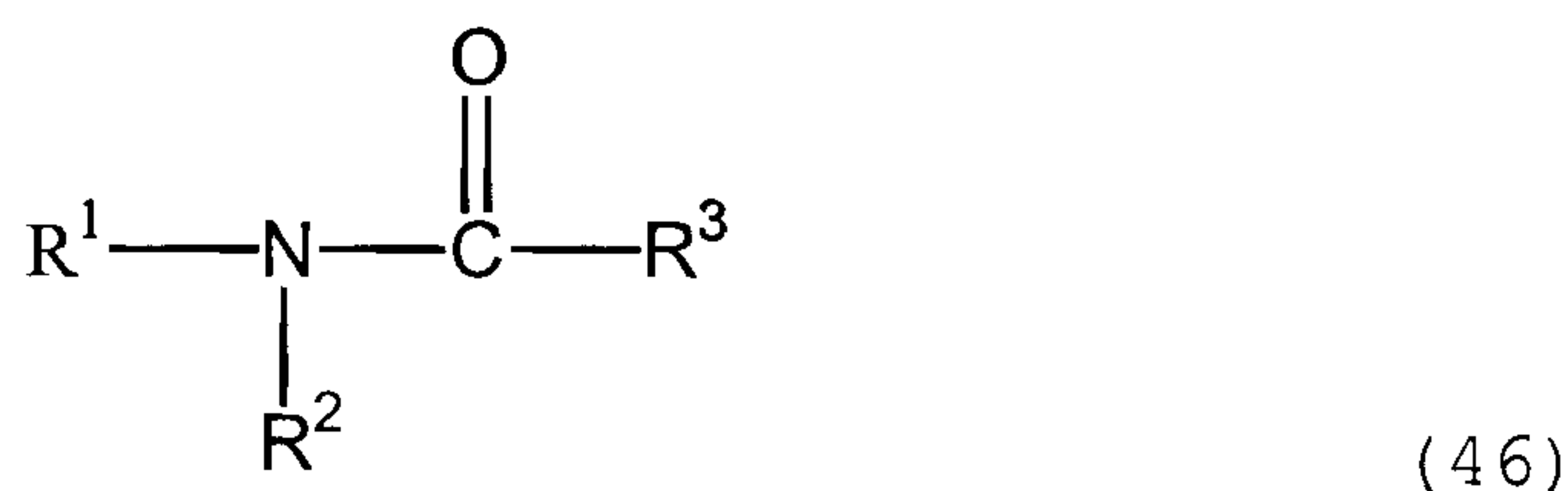

wherein R^1 is hydrocarbyl or substituted hydrocarbyl having from about 4 to about 30 carbon atoms, R^2 is hydrogen or hydrocarbyl or substituted hydrocarbyl having from 1 to about 30 carbon atoms, and R^3 is hydroxyalkyl, polyhydroxyalkyl, or poly(hydroxyalkyl)alkyl; (c) diamines having the formula:

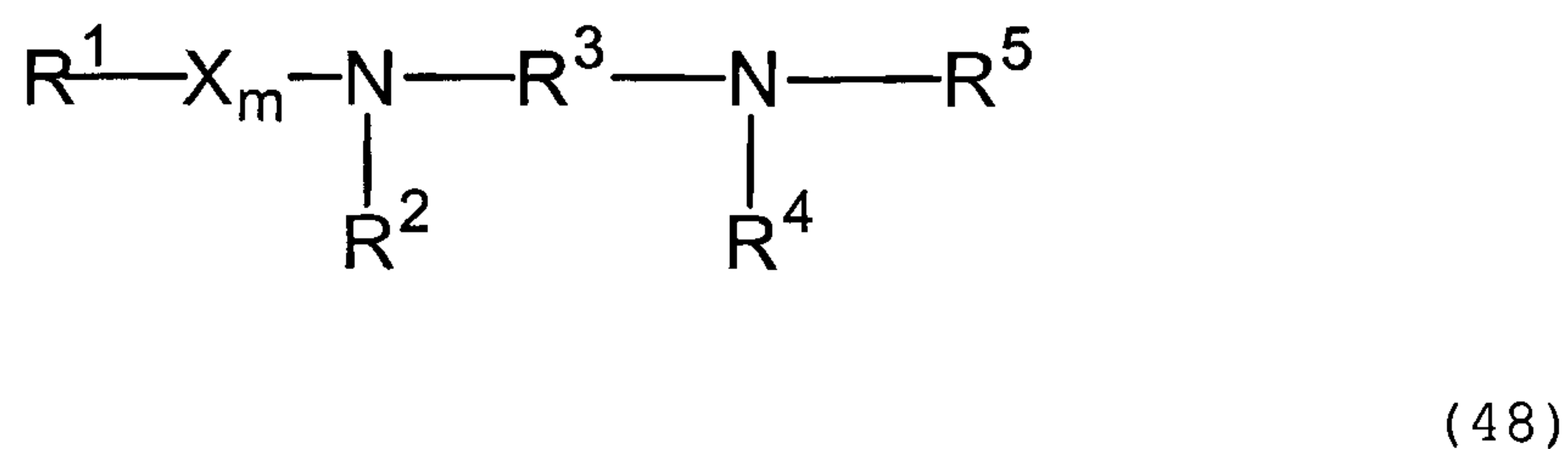

wherein R^1 , R^2 and R^5 are independently hydrogen or hydrocarbyl or substituted hydrocarbyl having from 1 to about 30 carbon atoms or $-R^8(OR^9)_nOR^{10}$, R^3 is hydrocarbylene

64725-903(D)

10q

or substituted hydrocarbylene having from 2 to about 18 carbon atoms, R^8 and R^9 are individually hydrocarbylene or substituted hydrocarbylene having from 2 to about 4 carbon atoms, R^4 and R^{10} are independently hydrogen or hydrocarbyl or substituted hydrocarbyl having from 1 to about 30 carbon atoms, m is 0 or 1, n is an average number from 0 to about 40, X is $-C(O)-$ or $-SO_2-$, and A^- is an agriculturally acceptable anion; (d) mono- or di-ammonium salts having the formula:

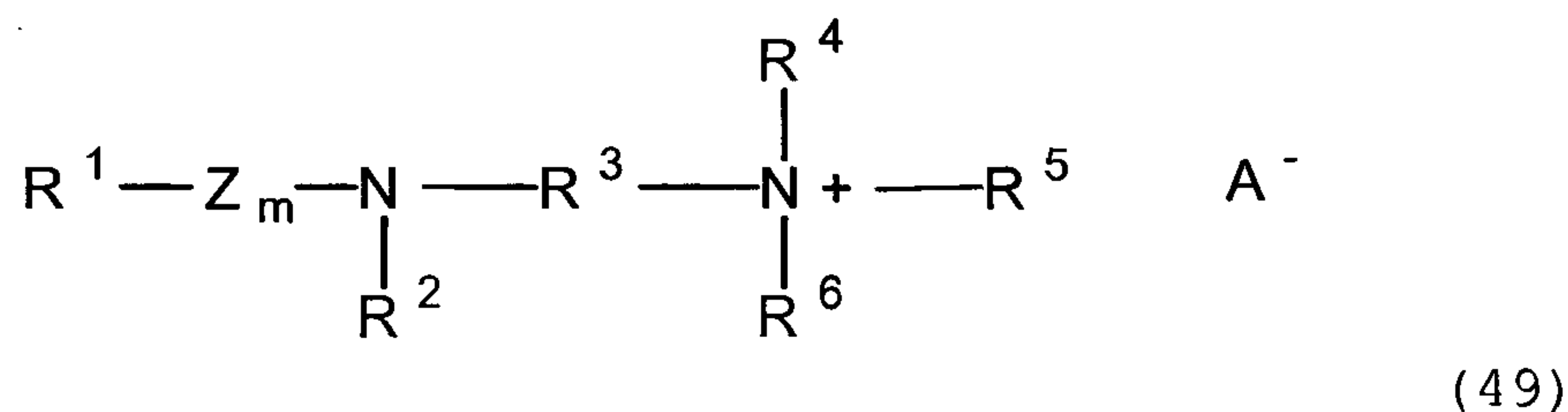

or

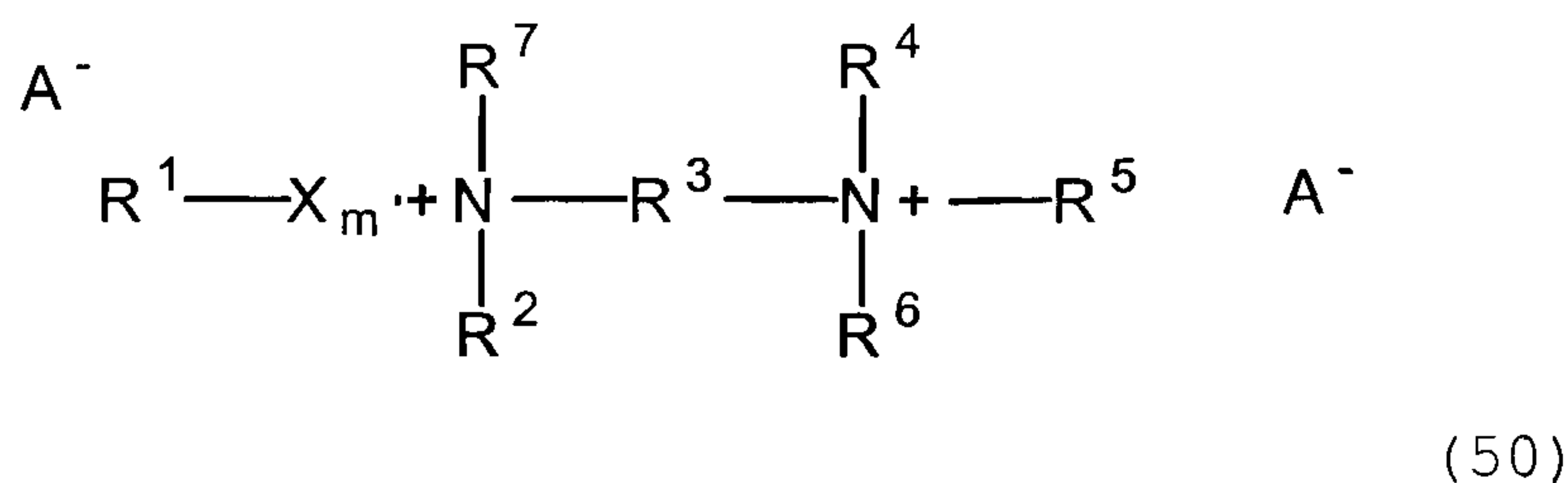

- 10 wherein R^1 , R^2 , R^4 , R^5 and R^7 are independently hydrogen or hydrocarbyl or substituted hydrocarbyl having from 1 to about 30 carbon atoms or $-R^8(OR^9)_nOR^{10}$, R^6 is hydrocarbyl or substituted hydrocarbyl having from about 1 to about 30 carbon atoms, R^3 is hydrocarbylene or substituted hydrocarbylene having from 2 to about 18 carbon atoms, R^8 , R^9 and R^{11} are individually hydrocarbylene or substituted hydrocarbylene having from 2 to about 4 carbon atoms, R^{10} is hydrogen or hydrocarbyl or substituted hydrocarbyl having from 1 to about 30 carbon atoms, m is 0 or 1, n is an

64725-903 (D)

10r

average number from 0 to about 40, X is -C(O)- or -SO₂-, Z is -C(O)-, and A⁻ is an agriculturally acceptable anion; (e) poly(hydroxyalkyl)amines having the formula:

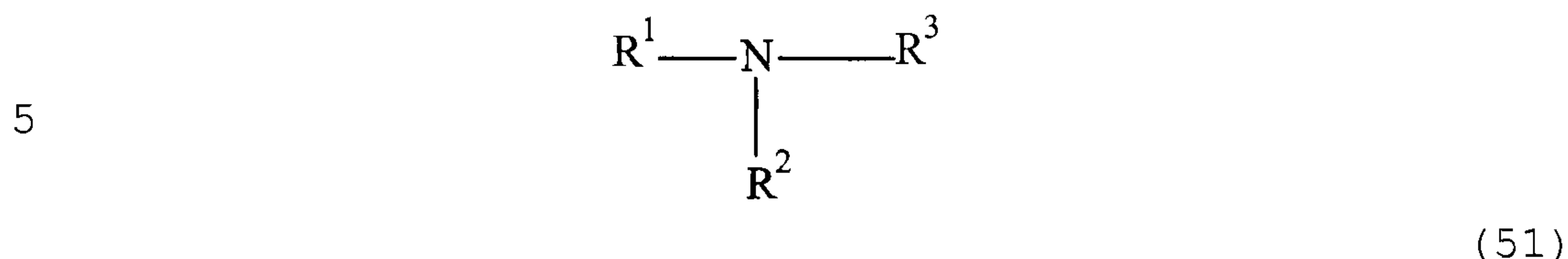

wherein R¹ is hydrocarbyl or substituted hydrocarbyl having from about 4 to about 30 carbon atoms or -R⁴OR⁵, R² is hydrogen or hydrocarbyl or substituted hydrocarbyl having from 1 to about 30 carbon atoms, R³ is hydroxyalkyl, polyhydroxyalkyl, or poly(hydroxyalkyl)alkyl, R⁴ is hydrocarbylene or substituted hydrocarbylene having from 2 to about 18 carbon atoms, and R⁵ is hydrogen or hydrocarbyl or substituted hydrocarbyl having from about 1 to about 30 carbon atoms; (f) di-poly(hydroxyalkyl)amine having the formula:

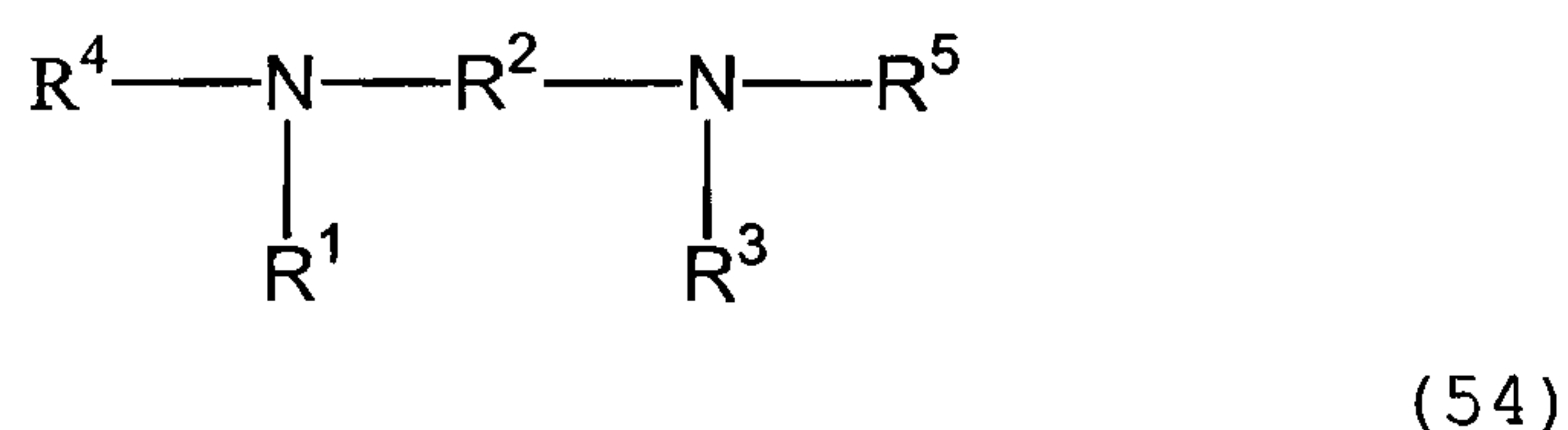

wherein R¹ and R³ are independently hydrogen or hydrocarbyl or substituted hydrocarbyl having from 1 to about 22 carbon atoms, R² is hydrocarbylene or substituted hydrocarbylene having from 2 to about 18 carbon atoms, and R⁴ and R⁵ are independently hydroxyalkyl, polyhydroxyalkyl, or poly(hydroxyalkyl)alkyl; (g) quaternary poly(hydroxyalkyl)amine salts having the formula:

64725-903 (D)

10s

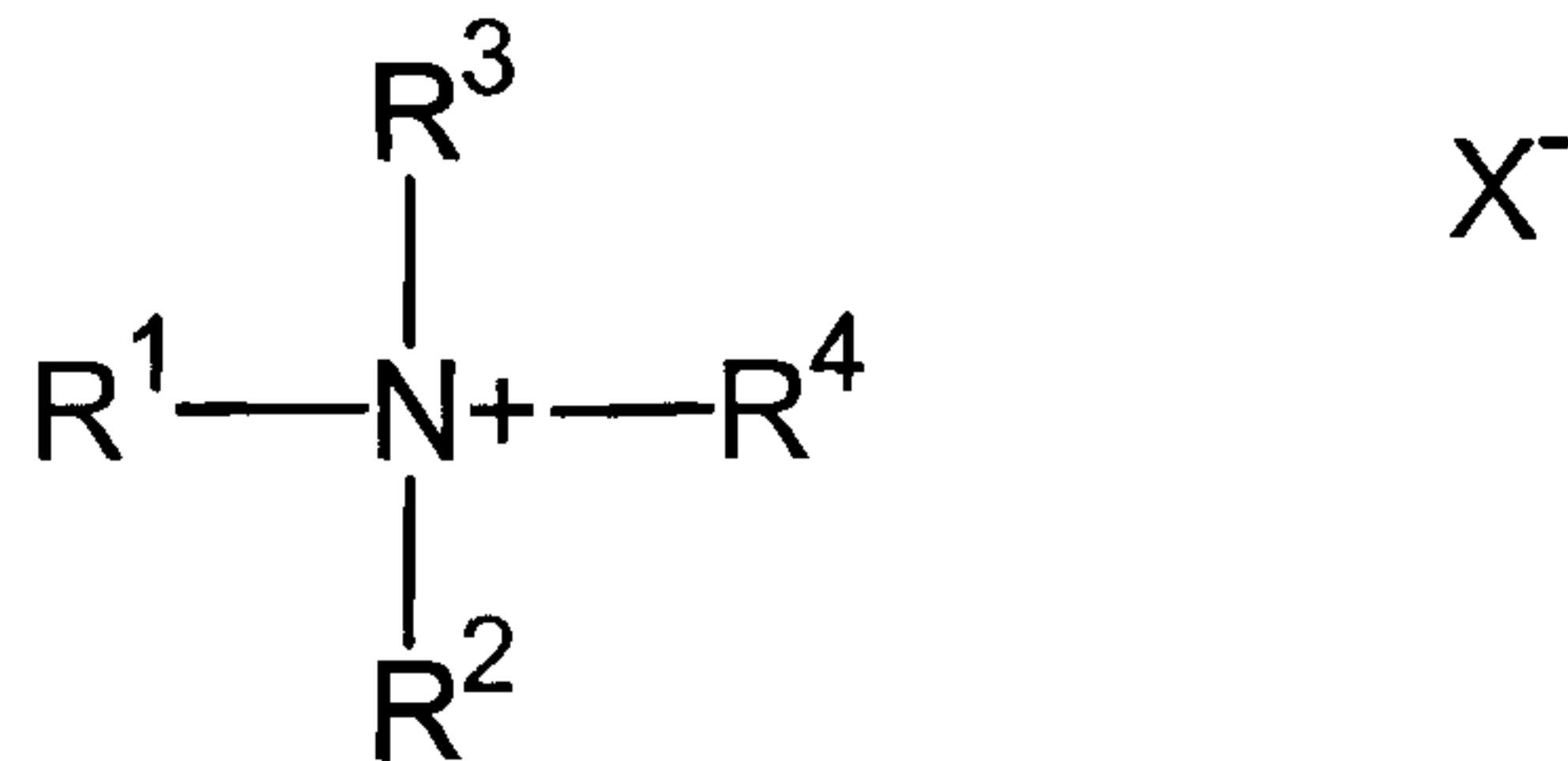

5

(56)

wherein R^1 is hydrocarbyl or substituted hydrocarbyl having from about 4 to about 30 carbon atoms, R^2 and R^3 are independently hydrogen or hydrocarbyl or substituted hydrocarbyl having from 1 to about 30 carbon atoms, and R^4 is hydroxyalkyl, polyhydroxyalkyl, or poly(hydroxyalkyl)alkyl;

(h) triamines having the formula:

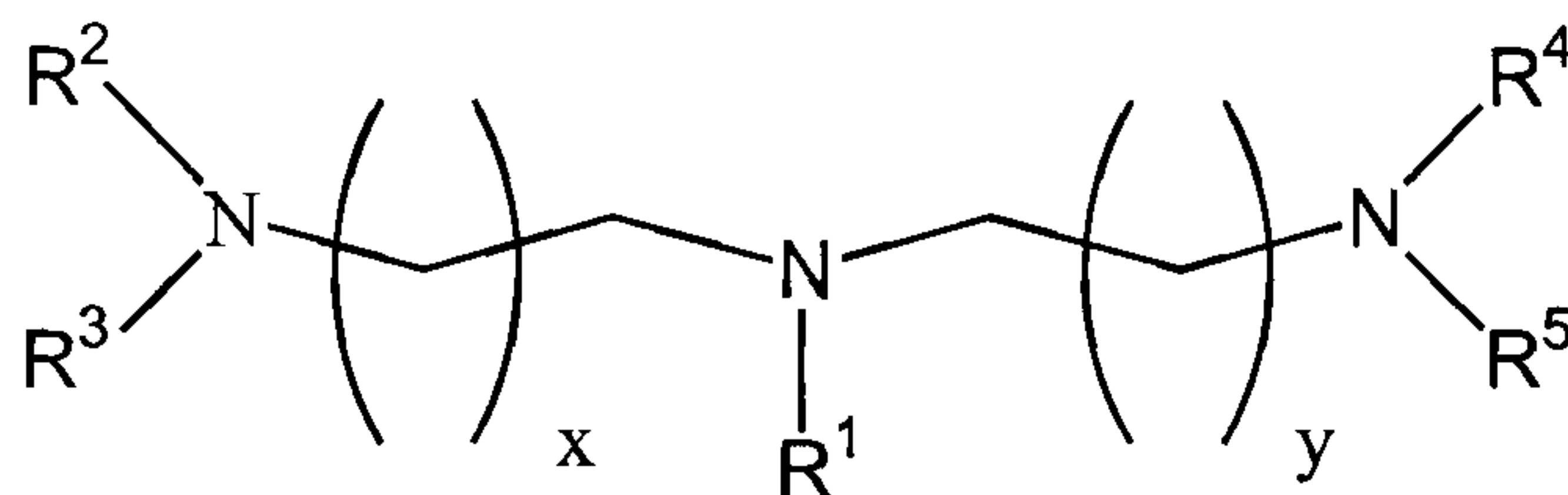

(59)

wherein R^1 is hydrocarbyl or substituted hydrocarbyl having from 1 to about 30 carbon atoms; R^2 , R^3 , R^4 and R^5 are independently hydrogen, hydrocarbyl or substituted hydrocarbyl having from 1 to about 30 carbon atoms, or $-(\text{R}^8)_s (\text{R}^7\text{O})_n \text{R}^6$; R^6 is hydrogen or a linear or branched alkyl group having from 1 to about 4 carbon atoms, R^7 in each of the n (R^7O) groups is independently $\text{C}_2\text{-C}_4$ alkylene; R^8 is hydrocarbylene or substituted hydrocarbylene having from 1 to about 6 carbon atoms, n is an average number from 1 to about 10, s is 0 or 1, and x and y are independently an integer from 1 to about 4; and mixtures thereof, wherein the pesticide is other than a bacteriocide if the composition includes a surfactant of group (a) or (d).

64725-903(D)

10t

According to another aspect of the invention of the parent application, there is provided an aqueous herbicidal concentrate formulation comprising: (i) glyphosate predominantly in the form of the potassium, monoammonium, diammonium, sodium, monoethanolamine, n-propylamine, ethylamine, ethylenediamine, hexamethylenediamine or trimethylsulfonium salt thereof, in solution in said water in an amount of in excess of 300 grams acid equivalent per liter of the formulation; and (ii) a surfactant component comprising one or more surfactant(s) in a total amount of about 20 to about 300 grams per liter of formulation, said surfactant(s) being selected from the group consisting of: (a) a secondary or tertiary amine having the formula:

15

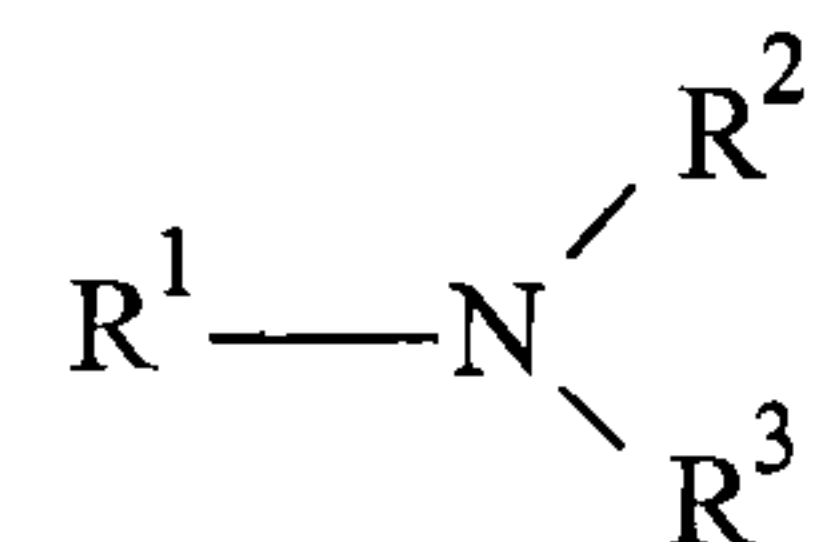

(63)

wherein R^1 and R^2 are hydrocarbyl having from 1 to about 30 carbon atoms, and R^3 is hydrogen or hydrocarbyl having from 1 to about 30 carbon atoms; (b) monoalkoxylated amines having the formula:

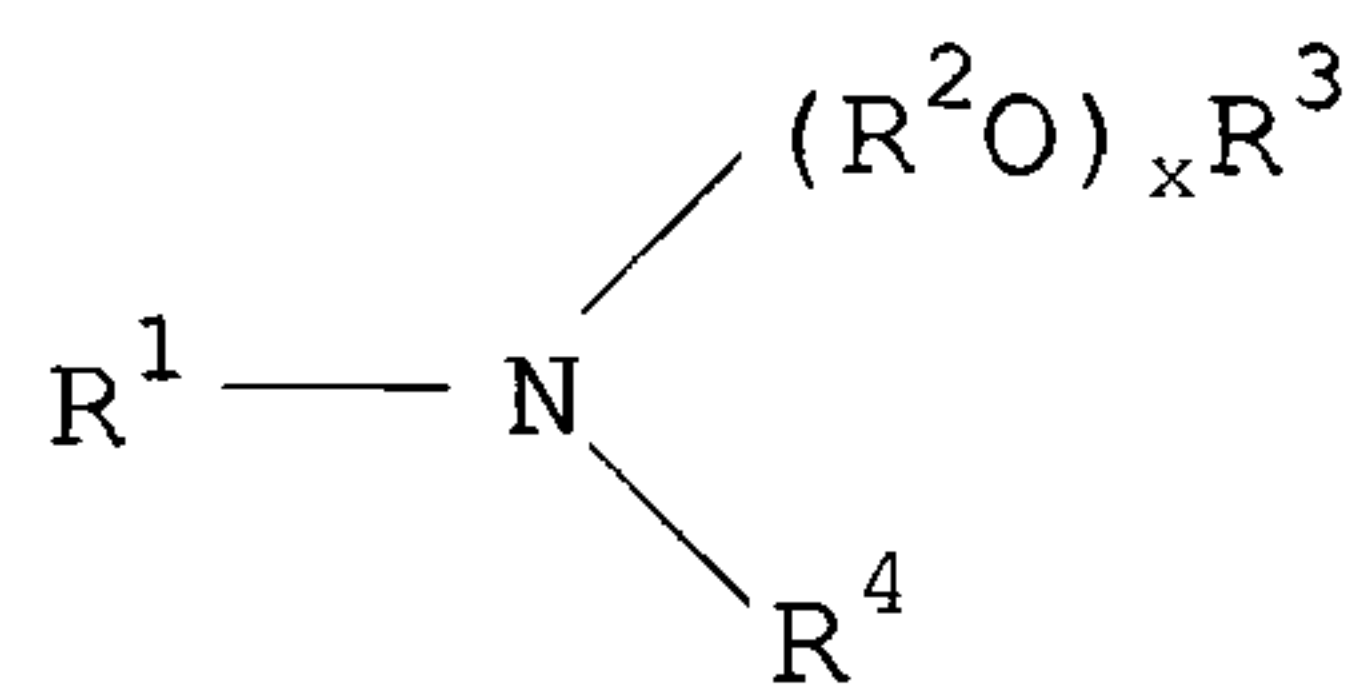

(64)

wherein R^1 and R^4 are independently hydrocarbyl or substituted hydrocarbyl groups having from 1 to about 30 carbon atoms or $-\text{R}^5\text{SR}^6$, R^2 in each of the x (R^2O) groups is independently $\text{C}_2\text{-C}_4$ alkylene, R^3 is hydrogen, or a linear or branched alkyl group having from 1 to about 4 carbon atoms,

64725-903 (D)

10u

R^5 is a linear or branched alkyl group having from about 6 to about 30 carbon atoms, R^6 is a hydrocarbyl or substituted hydrocarbyl group having from 4 to about 15 carbon atoms and x is an average number from 1 to about 60; (c)

5 dialkoxylated quaternary ammonium salt having the formula:

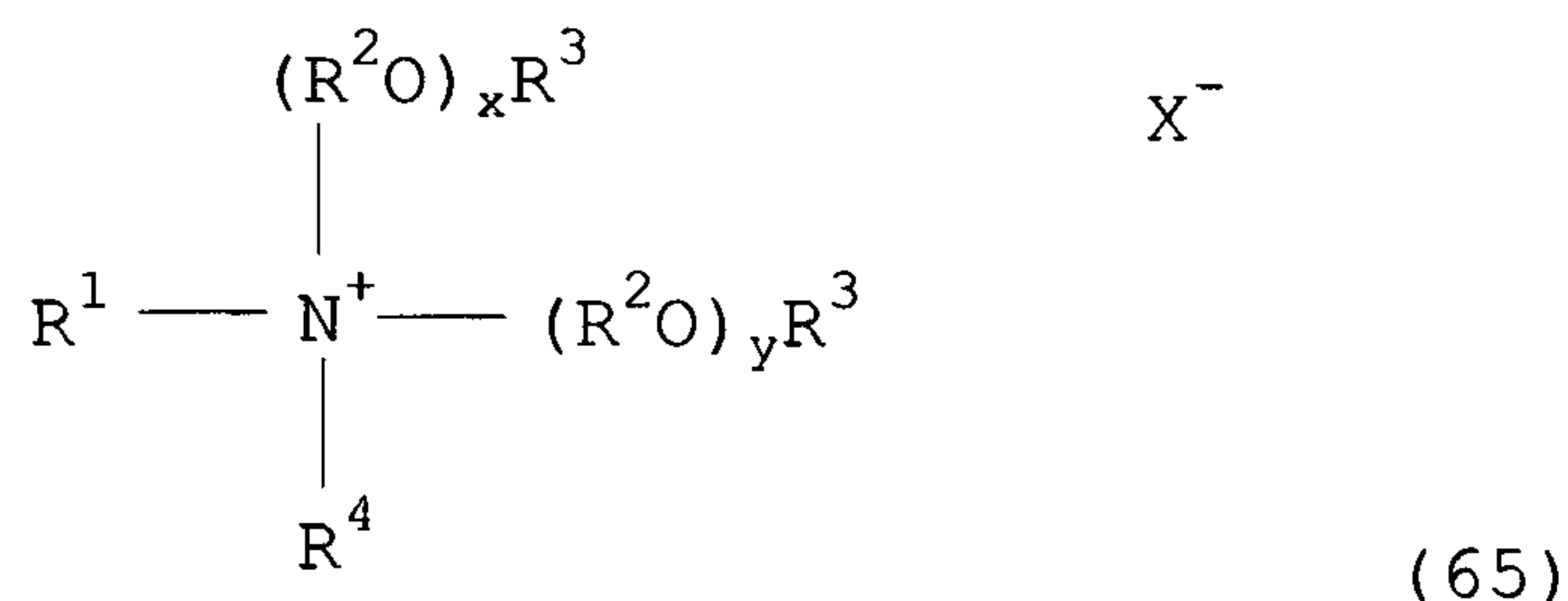

10 wherein R^1 is hydrocarbyl or substituted hydrocarbyl having from 1 to about 30 carbon atoms, R^2 in each of the x (R^2O) and y (R^2O) groups is independently C_2-C_4 alkylene, R^3 is hydrogen, or a linear or branched alkyl group having from 1 to about 4 carbon atoms, R^4 is hydrogen or hydrocarbyl or substituted hydrocarbyl having from 1 to about 30 carbon atoms, x and y are independently an average number from 1 to about 40, and X^- is an agriculturally acceptable anion; (d)

15 monoalkoxylated quaternary ammonium salt having the formula:

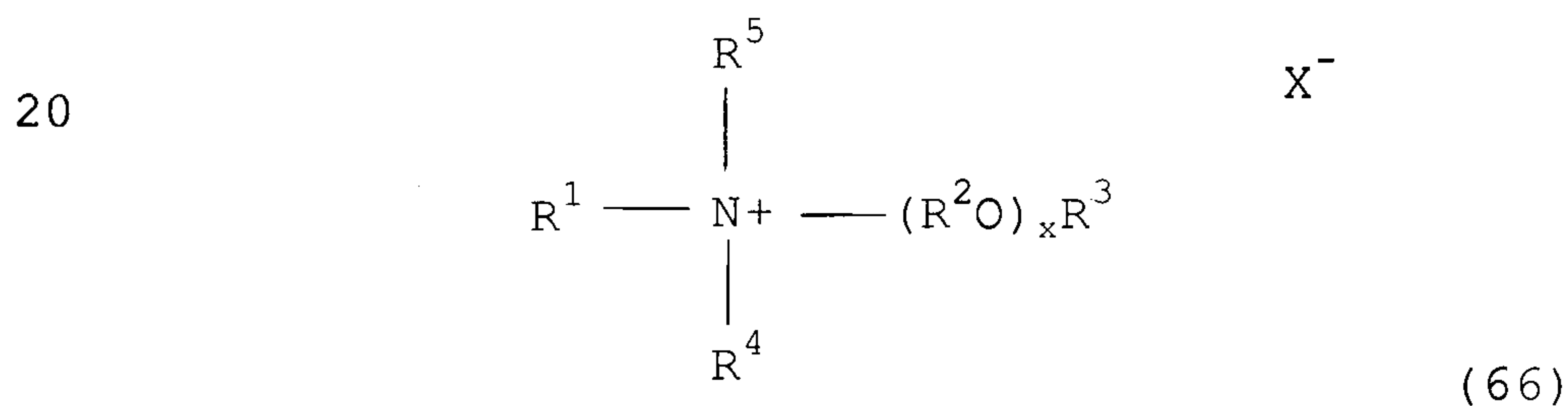

wherein R^1 and R^5 are independently hydrogen or hydrocarbyl or substituted hydrocarbyl having from 1 to about 30 carbon atoms, R^4 is hydrocarbyl or substituted hydrocarbyl having from 1 to about 30 carbon atoms, R^2 in each of the x (R^2O) groups is independently C_2-C_4 alkylene, R^3 is hydrogen, or a linear or branched alkyl group having from 1 to about 30

25

64725-903(D)

10v

carbon atoms, x is an average number from 1 to about 60, and X^- is an agriculturally acceptable anion; (e) quaternary ammonium salts having the formula:

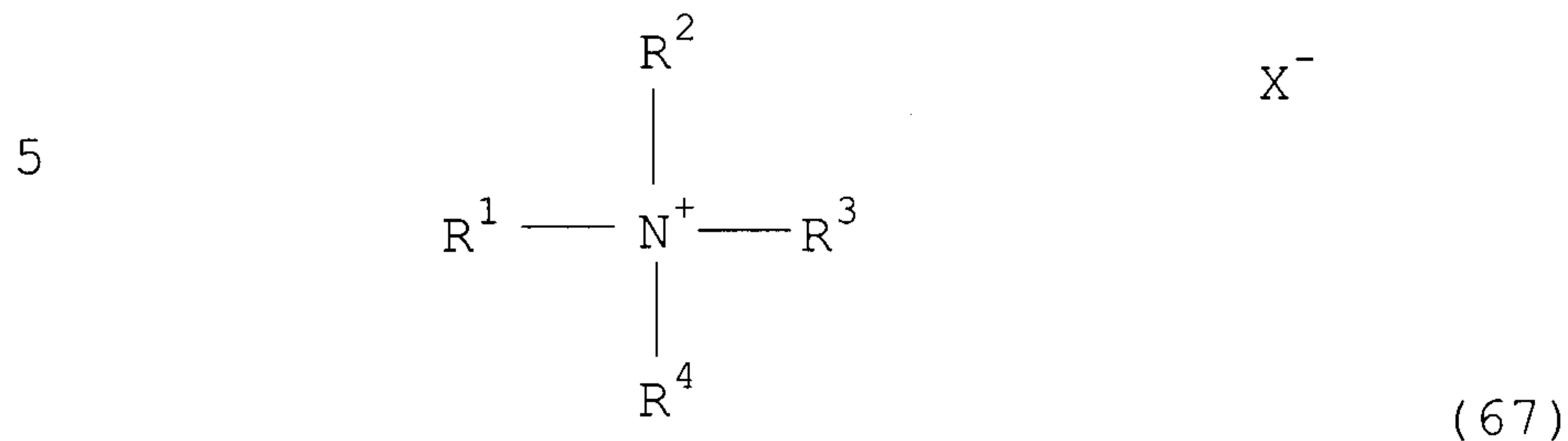

wherein R^1 , R^3 and R^4 are independently hydrogen or hydrocarbyl or substituted hydrocarbyl having from 1 to about 30 carbon atoms, R^2 is hydrocarbyl or substituted hydrocarbyl having from 1 to about 30 carbon atoms, and X^- is an agriculturally acceptable anion; (f) ether amines having the formula:

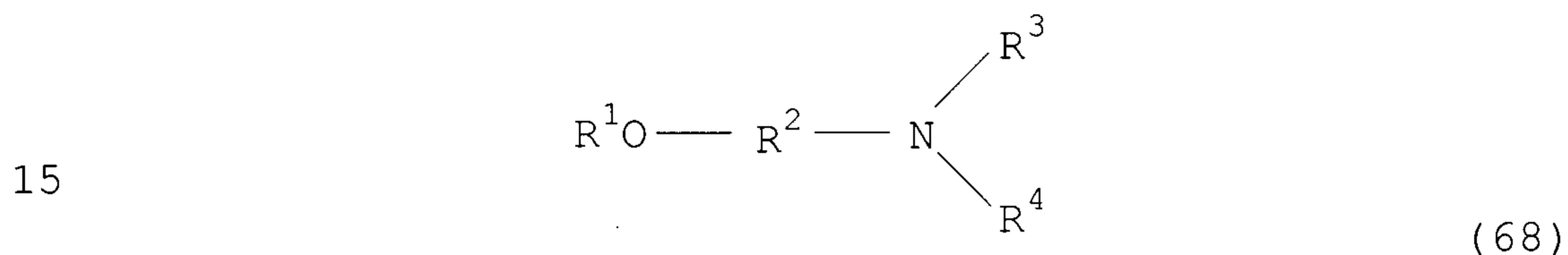

wherein R^1 is hydrocarbyl or substituted hydrocarbyl having from 1 to about 30 carbon atoms; R^2 is hydrocarbylene or substituted hydrocarbylene having from 2 to about 30 carbon atoms; R^3 and R^4 are independently hydrogen, hydrocarbyl or substituted hydrocarbyl having from 1 to about 30 carbon atoms, or $-(R^5O)_xR^6$, R^5 in each of the x (R^5-O) groups is independently C_2-C_4 alkylene, R^6 is hydrogen, or a linear or branched alkyl group having from 1 to about 4 carbon atoms, and x is an average number from 1 to about 50; (g) diamines having the formula:

64725-903 (D)

10w

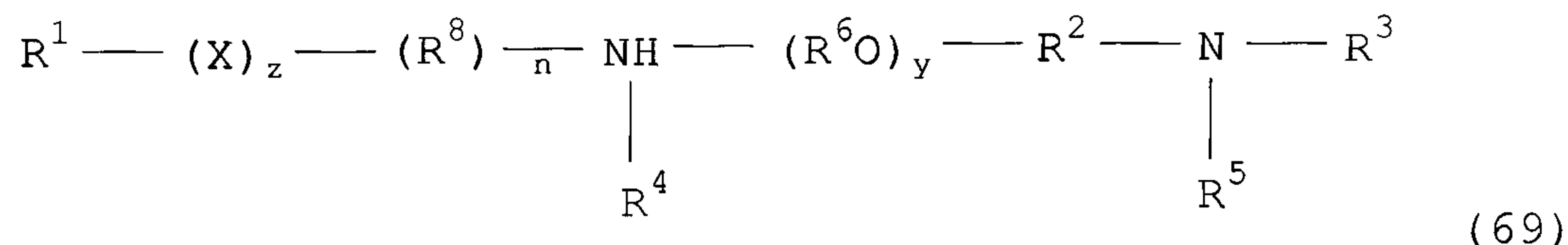

wherein R^1 , R^3 , R^4 and R^5 are independently hydrogen,
 5 hydrocarbyl or substituted hydrocarbyl having from 1 to
 about 30 carbon atoms, or $-(R^6O)_xR^7$; R^2 and R^8 are
 independently hydrocarbylene or substituted hydrocarbylene
 having from 2 to about 30 carbon atoms, R^6 in each of the
 x (R^6O) and y (R^8O) groups is independently C_2-C_4 alkylene, R^7
 10 is hydrogen, or a linear or branched alkyl group having
 from 1 to about 30 carbon atoms, x is an average number
 from 1 to about 30, X is $-O-$, $-N(R^6)-$, $-C(O)-$, $-C(O)O-$,
 $-OC(O)-$, $-N(R^9)C(O)-$, $-C(O)N(R^9)-$, $-S-$, $-SO-$, or $-SO_2-$, y
 15 is 0 or an average number from 1 to about 30, n and z are
 independently 0 or 1, and R^9 is hydrogen or hydrocarbyl or
 substituted hydrocarbyl; (h) amine oxides having the
 formula:

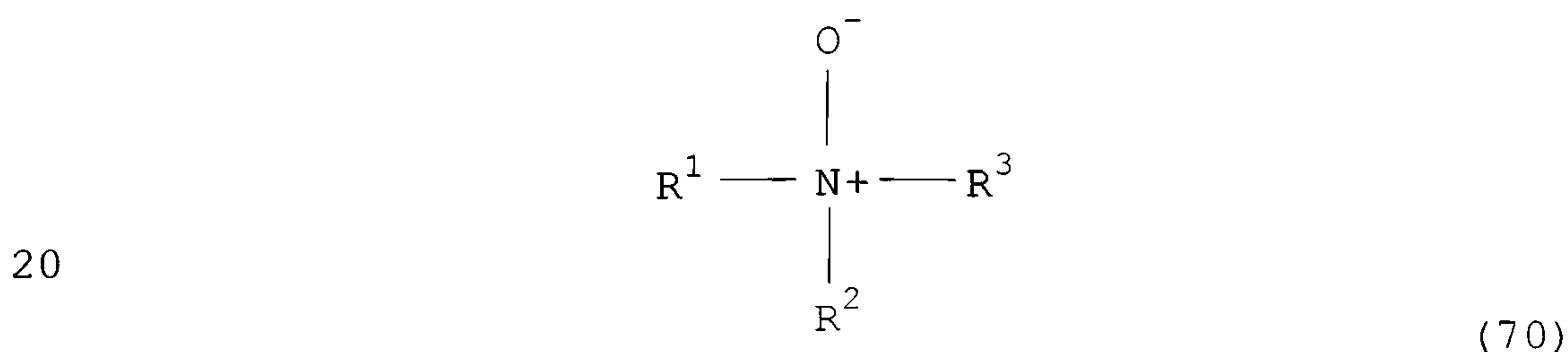

wherein R^1 , R^2 and R^3 are independently hydrogen, hydrocarbyl
 or substituted hydrocarbyl, $-(R^4O)_xR^5$, or $-R^6(OR^4)_xOR^5$; R^4 in
 each of the x (R^4O) groups is independently C_2-C_4 alkylene, R^5
 25 is hydrogen, or a linear or branched alkyl group having
 from 1 to about 30 carbon atoms, R^6 is hydrocarbylene or
 substituted hydrocarbylene having from 2 to about 6 carbon
 atoms, x is an average number from 1 to about 50, and the

64725-903 (D)

10x

total number of carbon atoms in R¹, R² and R³ is at least 8;

(i) dialkoxylated amines having the formula:

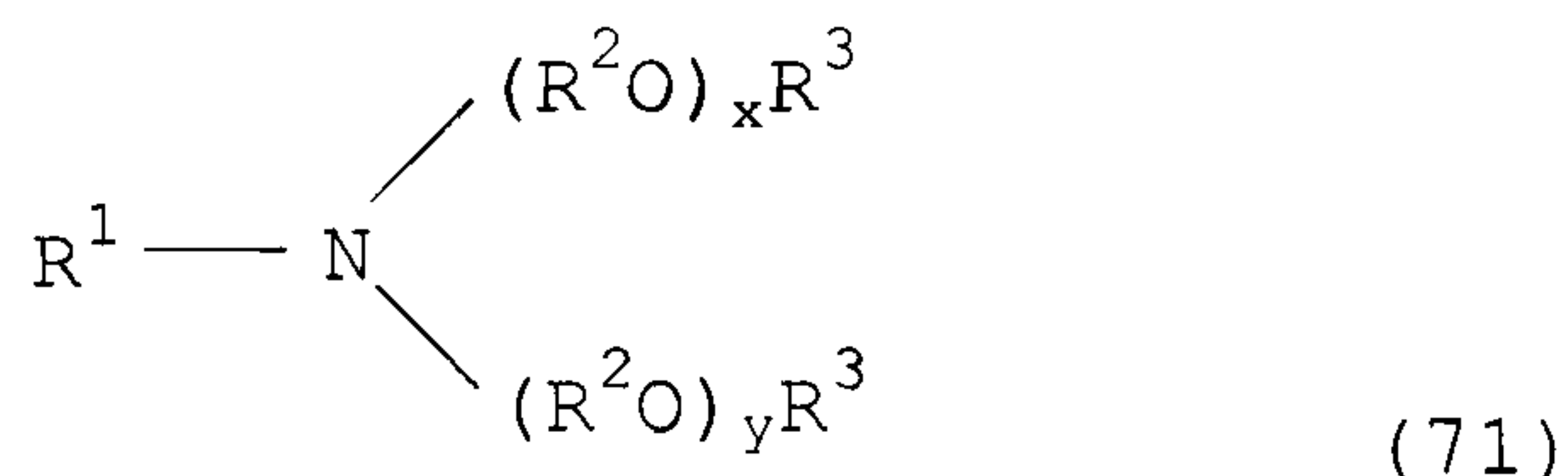

5

wherein R¹ is a linear or branched alkyl, linear or branched alkenyl, linear or branched alkynyl, aryl, or aralkyl group having from about 6 to about 30 carbon atoms, or -R⁴SH, R² in each of the x (R²O) and the y (R²O) groups is independently C₂-C₄ alkylene, R³ is hydrogen, or a linear or branched alkyl group having from 1 to about 4 carbon atoms, R⁴ is a linear or branched alkyl group having from about 6 to about 30 carbon atoms, and x and y are independently an average number from 1 to about 40; (j) aminated alkoxyated alcohols having the following chemical structure:

10

15

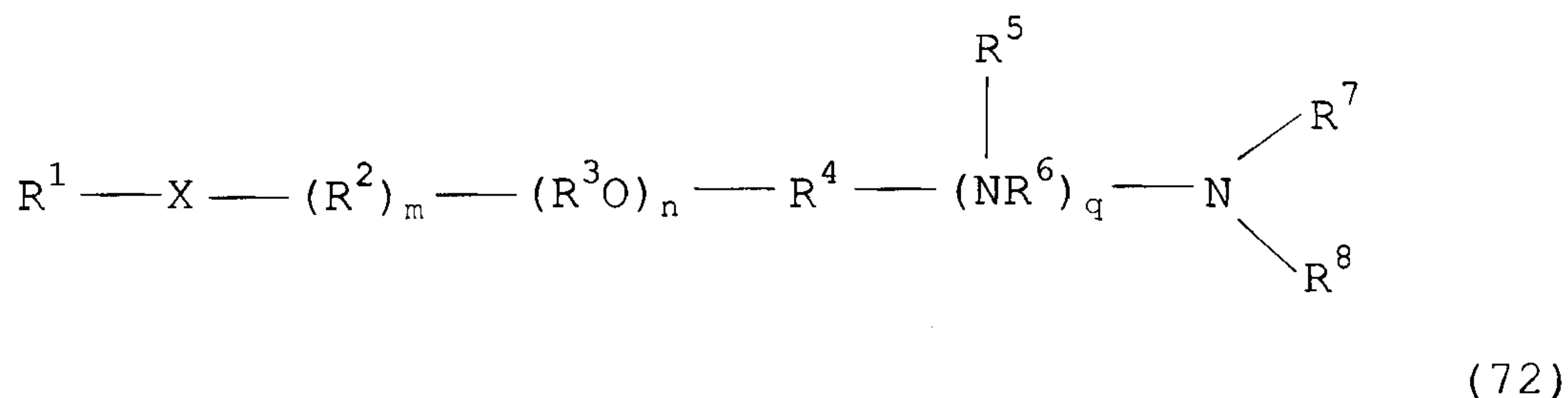

20

25

30

wherein R¹, R⁷, R⁸, and R⁹ are each independently hydrogen, hydrocarbyl or substituted hydrocarbyl having from 1 to about 30 carbon atoms, or -(R¹¹)_s(R³O)_vR¹⁰; X is -O-, -OC(O)-, -C(O)O-, -N(R¹²)C(O)-, -C(O)N(R¹²)-, -S-, -SO-, -SO₂- or -N(R⁹)-; R³ in each of the n (R³O) groups and the v (R³O) groups is independently C₂-C₄ alkylene; R¹⁰ is hydrogen, or a linear or branched alkyl group having from 1 to about 30 carbon atoms; n is an average number from 1 to about 60; v is an average number from 1 to about 50; R² and R¹¹ are each independently hydrocarbylene or substituted hydrocarbylene having from 1 to about 6 carbon atoms; R⁴ is hydrocarbylene

64725-903 (D)

10y

or substituted hydrocarbylene having from 2 to about 6 carbon atoms; R¹² is hydrogen or hydrocarbyl or substituted hydrocarbyl having from 1 to about 30 carbon atoms; m and s are each independently 0 or 1; R⁶ is hydrocarbylene or substituted hydrocarbylene having from 2 to about 30 carbon atoms, -C(=NR¹²)-, -C(S)-, or -C(O)-; q is an integer from 0 to 5; and R⁵ is hydrogen or hydrocarbyl or substituted hydrocarbyl having from 1 to about 30 carbon atoms; (k) quaternary ammonium, sulfonium and sulfoxonium salts having the formula:

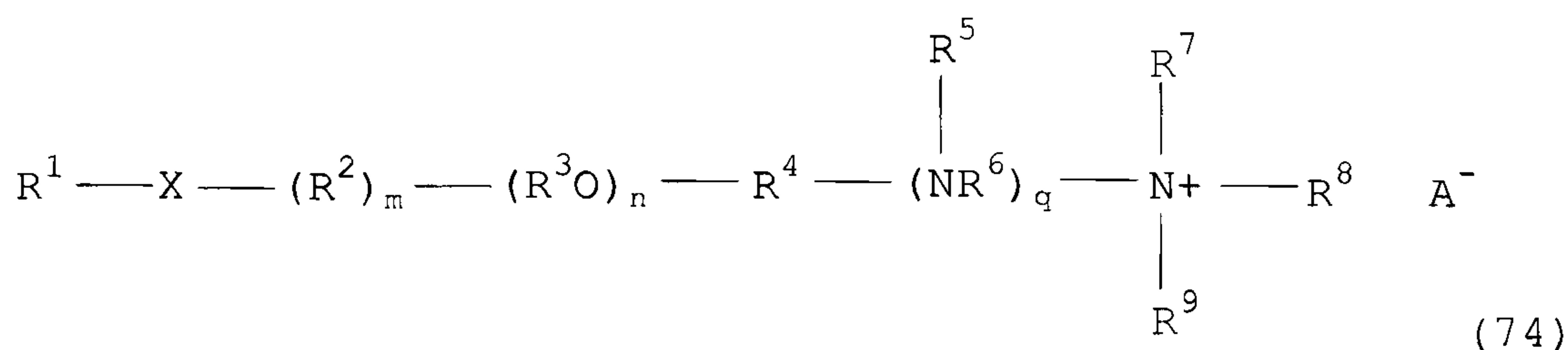

or

15

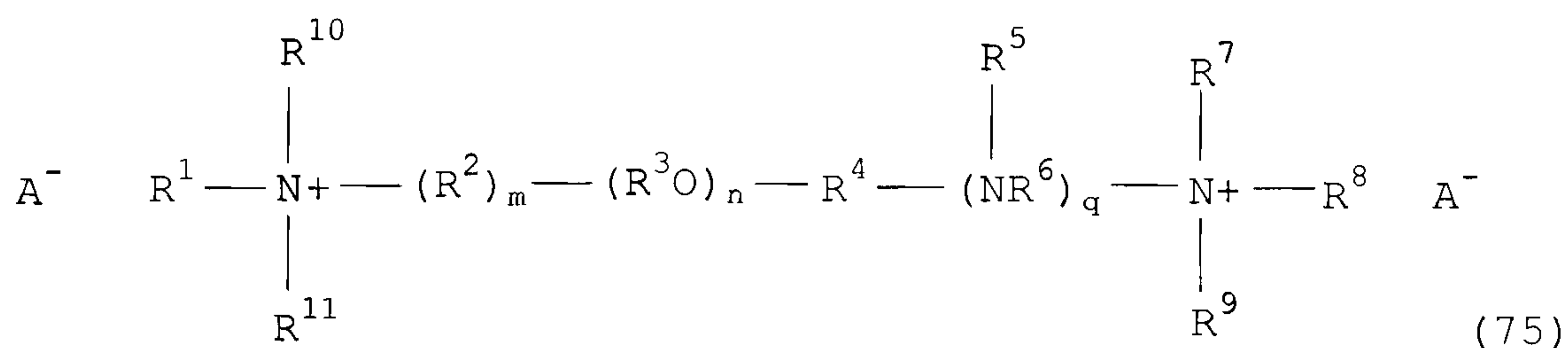

or

20

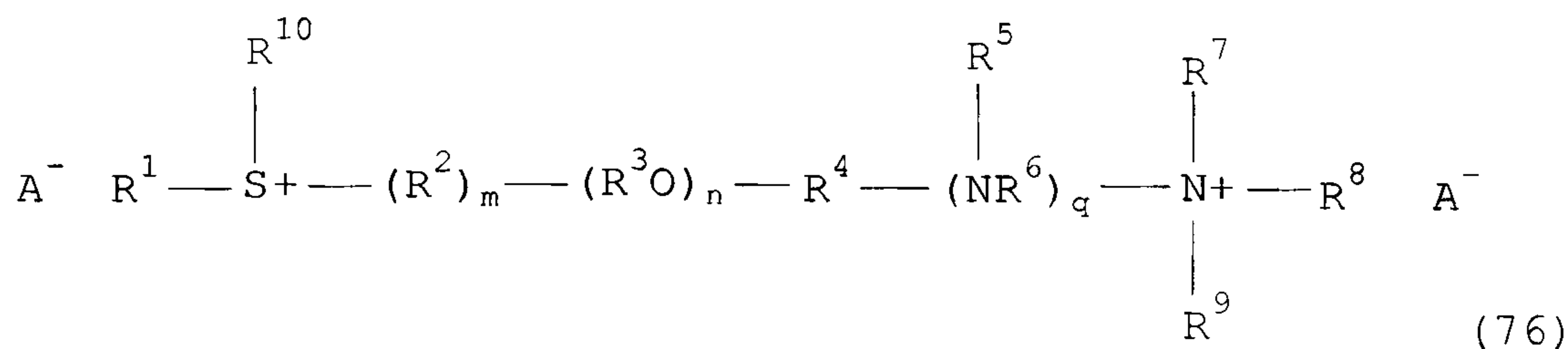

or

64725-903 (D)

10z

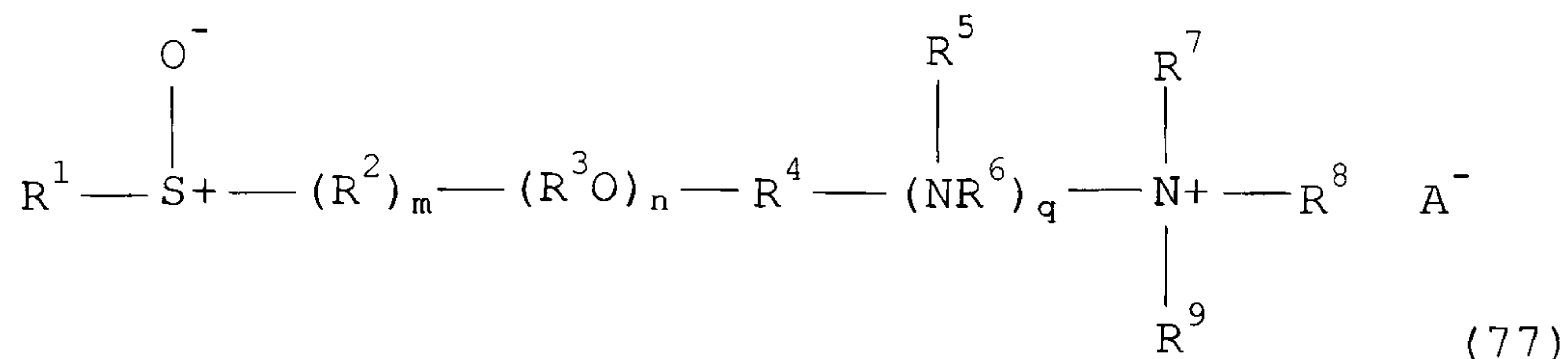

- 5 wherein R^1 , R^7 , R^8 , R^9 , R^{10} and R^{11} are independently hydrogen, hydrocarbyl, or substituted hydrocarbyl having from 1 to about 30 carbon atoms, or $-(\text{R}^{13})_s(\text{R}^3\text{O})_v\text{R}^{12}$; X is $-\text{O}-$, $-\text{OC}(\text{O})-$, $-\text{N}(\text{R}^{14})\text{C}(\text{O})-$, $-\text{C}(\text{O})\text{N}(\text{R}^{14})-$, $-\text{C}(\text{O})\text{O}-$, or $-\text{S}-$; R^3 in each of the n (R^3O) groups and the v (R^3O) groups is independently
- 10 C_2 C_4 alkylene; R^{12} is hydrogen, or a linear or branched alkyl group having from 1 to about 30 carbon atoms; n is an average number from 1 to about 60; v is an average number from 1 to about 50; R^2 and R^{13} are each independently hydrocarbylene or substituted hydrocarbylene having
- 15 from 1 to about 6 carbon atoms; m and s are each independently 0 or 1; R^4 is hydrocarbylene or substituted hydrocarbylene having from 2 to about 6 carbon atoms; R^6 is hydrocarbylene or substituted hydrocarbylene having from 2 to about 30 carbon atoms, $-\text{C}(=\text{NR}^{12})-$, $-\text{C}(\text{S})-$, or $-\text{C}(\text{O})-$; R^{14}
- 20 is hydrogen or hydrocarbyl or substituted hydrocarbyl having from 1 to about 30 carbon atoms, q is an integer from 0 to 5; R^5 is hydrogen or hydrocarbyl or substituted hydrocarbyl having from 1 to about 30 carbon atoms; and each A^- is an agriculturally acceptable anion; (1) a diamine or diammonium
- 25 salt having the formula:

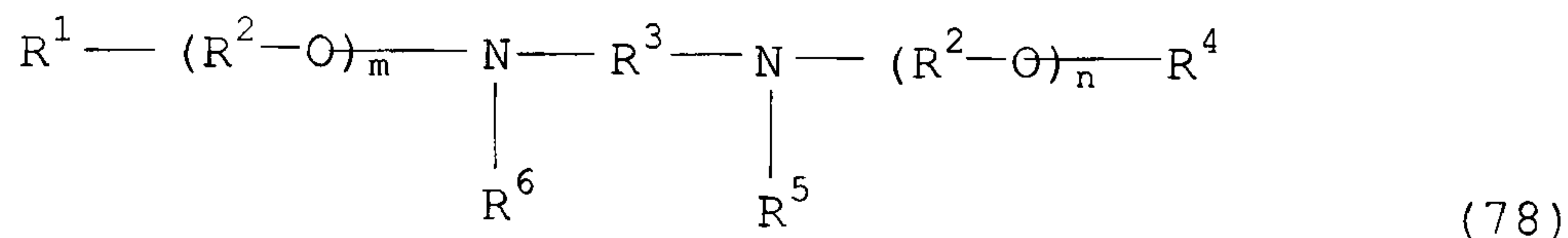

64725-903(D)

10aa

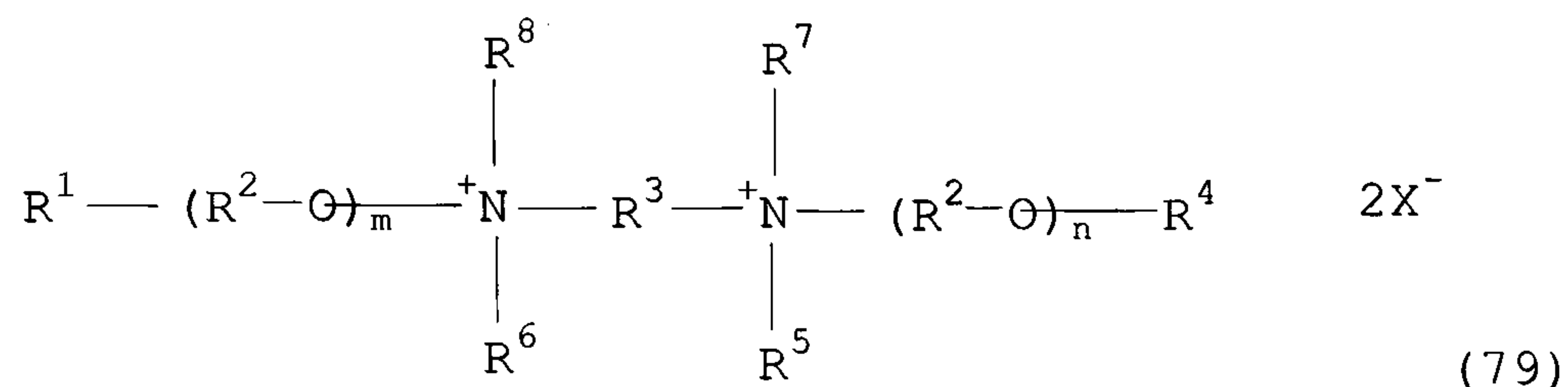

5 wherein R¹, R⁴, R⁵, R⁶, R⁷ and R⁸ are independently hydrogen or hydrocarbyl or substituted hydrocarbyl having from 1 to about 30 carbon atoms, R² in each of the m (R²O) and n (R²O) groups and R⁹ are independently C₂-C₄ alkylene, R³ is
 10 hydrocarbylene or substituted hydrocarbylene having from about 2 to about 6 carbon atoms or -(R²O)_pR⁹-, m and n are individually an average number from 0 to about 50, and p is an average number from 0 to about 60; (m) alkoxyated alcohols having the formula:

15

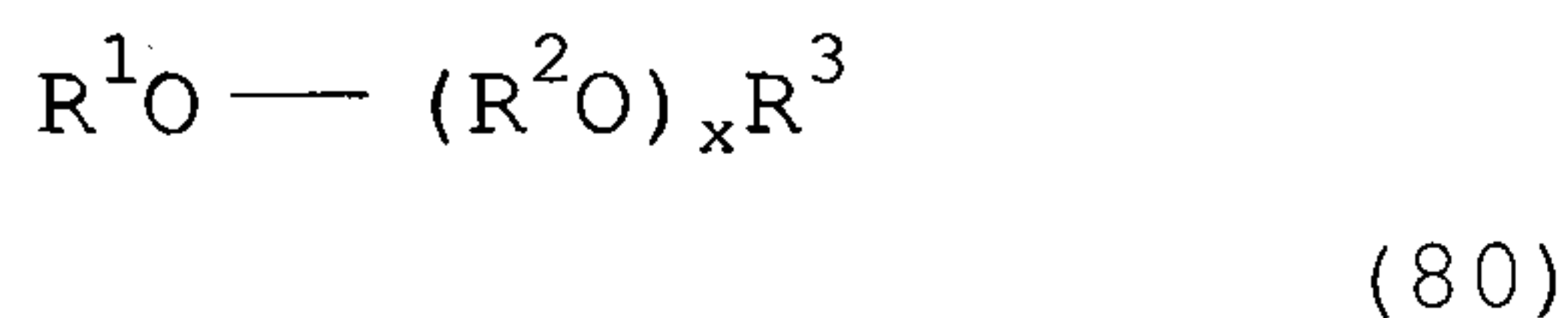

wherein R¹ is hydrocarbyl or substituted hydrocarbyl having from 1 to about 30 carbon atoms, R² in each of the x (R²O) groups is independently C₂-C₄ alkylene, R³ is hydrogen, or a
 20 linear or branched alkyl group having from 1 to about 4 carbon atoms, and x is an average number from 1 to about 60; (n) alkoxyated dialkylphenols having the formula:

25

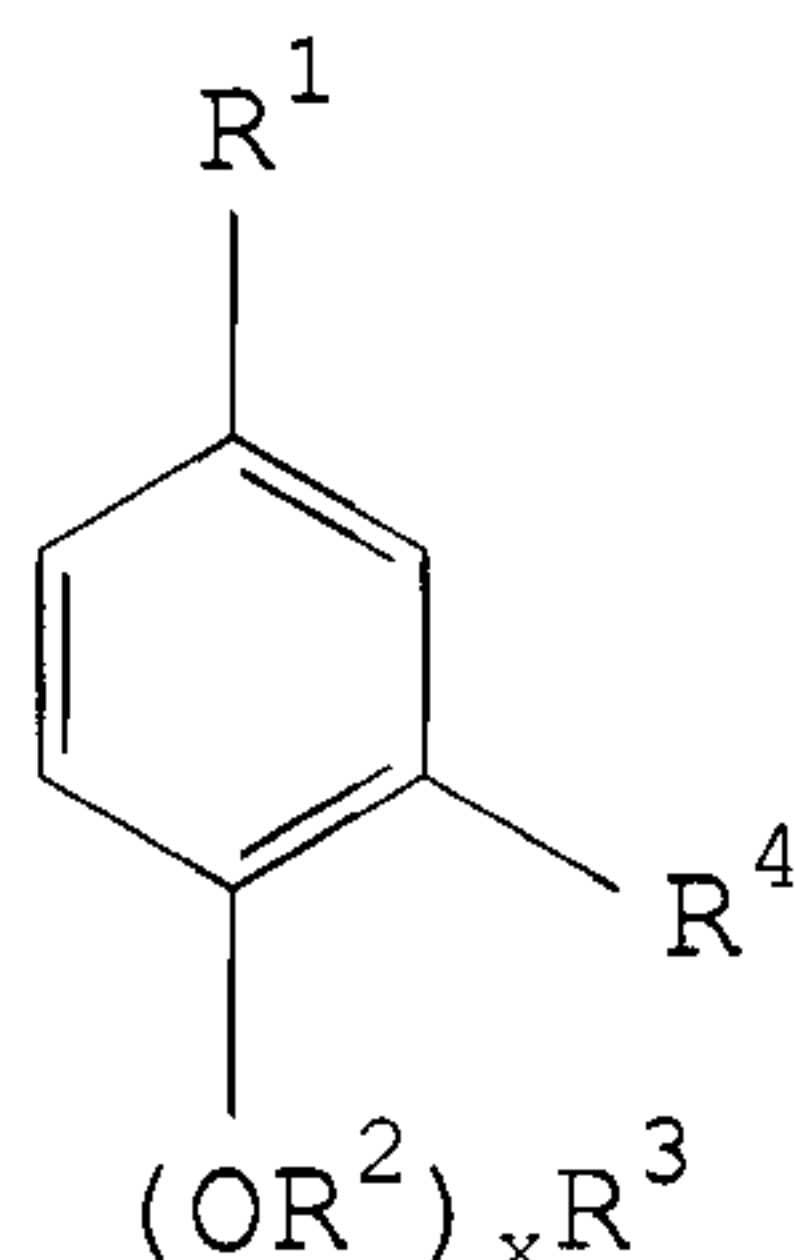

(81)

64725-903(D)

10bb

wherein R^1 and R^4 are independently hydrogen, or a linear or branched alkyl group having from 1 to about 30 carbon atoms and at least one of R^1 and R^4 is an alkyl group, R^2 in each of the x (R^2O) groups is independently C_2-C_4 alkylene, R^3 is
 5 hydrogen, or a linear or branched alkyl group having from 1 to about 4 carbon atoms, and x is an average number from 1 to about 60; and mixtures thereof.

According to one aspect of the invention of the present divisional application, there is provided a
 10 surfactant compound selected from the group consisting of:
 (a) monoalkoxylated amines having the formula:

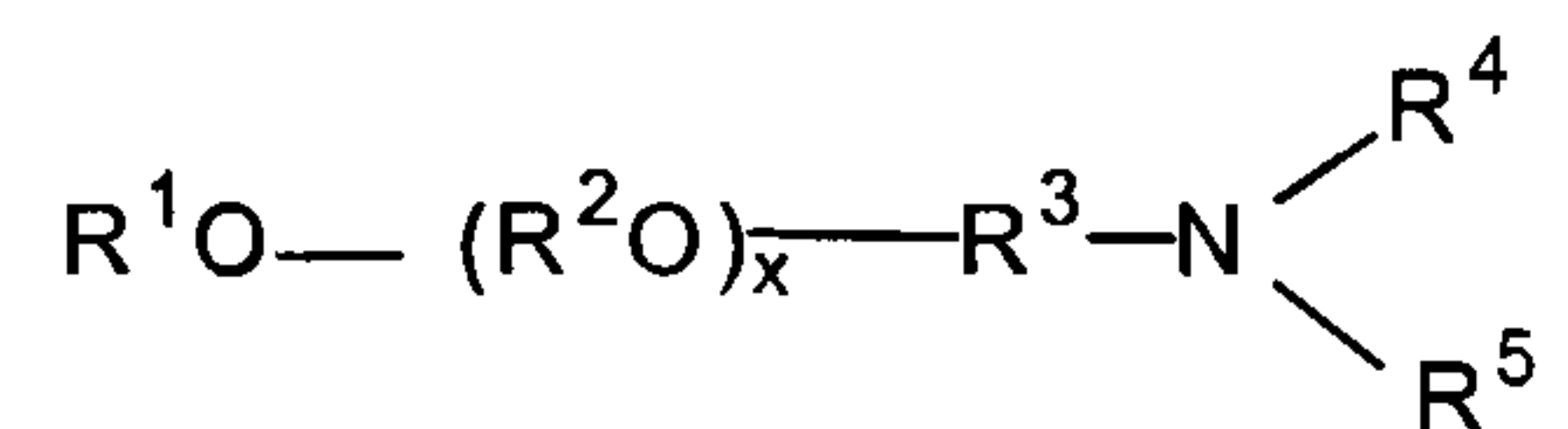

15

(23)

wherein R^1 is hydrogen or hydrocarbyl or substituted hydrocarbyl having at least 7 carbon atoms; R^2 in each of the x (R^2O) and y (R^2O) groups is independently C_2-C_4 alkylene; R^3 is a hydrocarbylene or substituted hydrocarbylene having
 20 from 2 to about 6 carbon atoms; R^4 and R^5 are each independently hydrogen, hydrocarbyl or substituted hydrocarbyl having from 1 to about 30 carbon atoms, $-(R^6)_n-(R^2O)_yR^7$, or R^4 and R^5 , together with the nitrogen atom to which they are attached, form a cyclic or heterocyclic
 25 ring; R^6 is hydrocarbylene or substituted hydrocarbylene containing from 1 to about 6 carbon atoms, R^7 is hydrogen or a linear or branched alkyl group having 1 to about 4 carbon atoms, n is 0 or 1, and x and y are independently an average number from 1 to about 60, provided, however, that when R^2
 30 and R^3 in each of the x (R^2O) groups is ethylene, R^1 is other than unsubstituted alkyl or R^4 is other than hydrogen or

64725-903(D)

10cc

unsubstituted alkyl when R^5 is hydrogen or unsubstituted alkyl, and when R^2 and R^3 are isopropylene and x is 1, R^1 is other than unsubstituted alkyl or R^4 is other than $-(R^2O)_yR^7$;

(b) alkoxyated poly(hydroxyalkyl)amines having the formula:

5

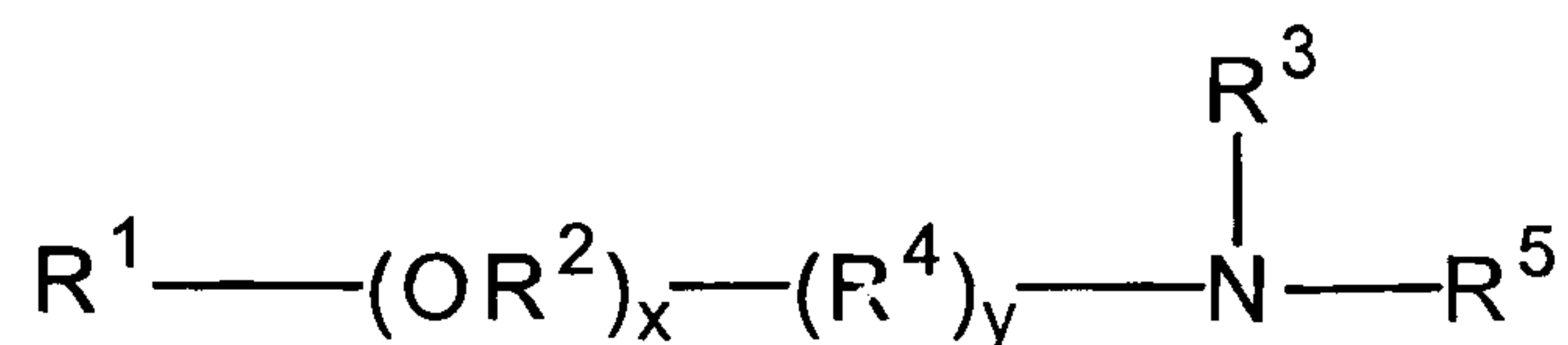

(24)

wherein R^1 and R^3 are independently hydrogen, hydrocarbyl or substituted hydrocarbyl having from 1 to about 30 carbon atoms, R^2 in each of the x (R^2O) groups is independently C_2-C_4 alkylene; R^4 is hydrocarbylene or substituted hydrocarbylene having from 1 to about 30 carbon atoms, R^5 is hydroxyalkyl, polyhydroxyalkyl, or poly(hydroxyalkyl)alkyl; x is an average number from 0 to about 30, and y is 0 or 1;

(c) di-poly(hydroxyalkyl)amines having the formula:

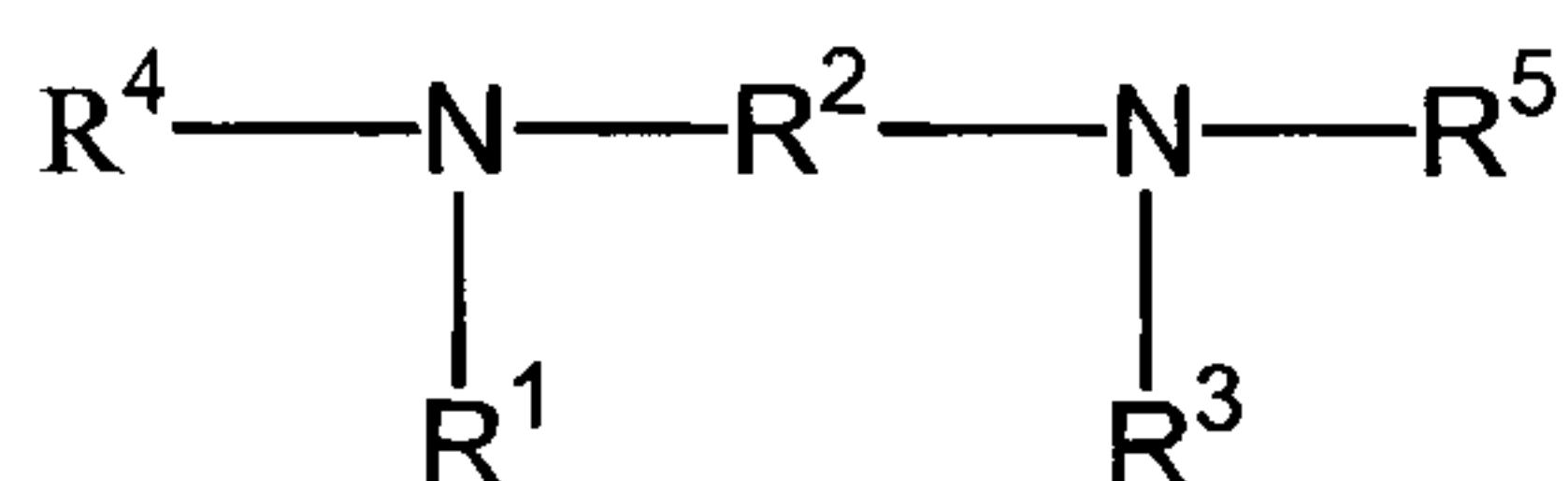

(27)

wherein R^1 and R^3 are independently hydrogen or hydrocarbyl or substituted hydrocarbyl having from 1 to about 22 carbon atoms, R^2 is hydrocarbylene or substituted hydrocarbylene having from 2 to about 18 carbon atoms, R^4 and R^5 are independently hydroxyalkyl, polyhydroxyalkyl, or poly(hydroxyalkyl)alkyl, provided, however, that when R^1 and R^3 are methyl, R^2 is other than octylene; (d) alkoxyated triamines having the formula:

64725-903(D)

10dd

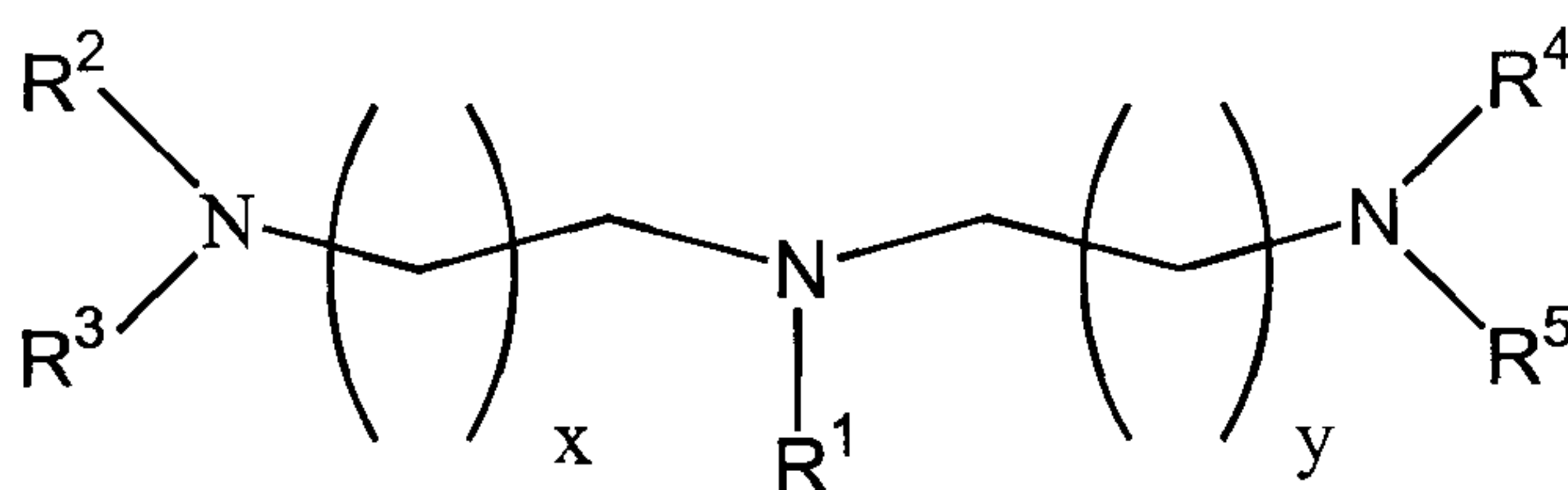

(29)

wherein R^1 is hydrocarbyl or substituted hydrocarbyl having
 5 from 1 to about 30 carbon atoms; R^2 , R^3 , R^4 and R^5 are
 independently hydrogen, hydrocarbyl or substituted
 hydrocarbyl having from 1 to about 30 carbon atoms, or
 $-(R^8)_s(R^7-O)_nR^6$; R^6 is hydrogen, or a linear or branched alkyl
 group having from 1 to about 4 carbon atoms; R^7 in each of
 10 the n (R^7O) groups is independently C_2-C_4 alkylene; R^8 is
 hydrocarbylene or substituted hydrocarbylene having from 1
 to about 6 carbon atoms; n is an average number from 1 to
 about 10; s is 0 or 1; and x and y are independently an
 integer from 1 to about 4; provided, however, that when R^1 is
 15 alkyl, R^2 is other than hydrogen, x is 3 or 4, or R^4 is other
 than $-(R^7-O)_nR^6$; (e) monoalkoxylated amines having the
 formula:

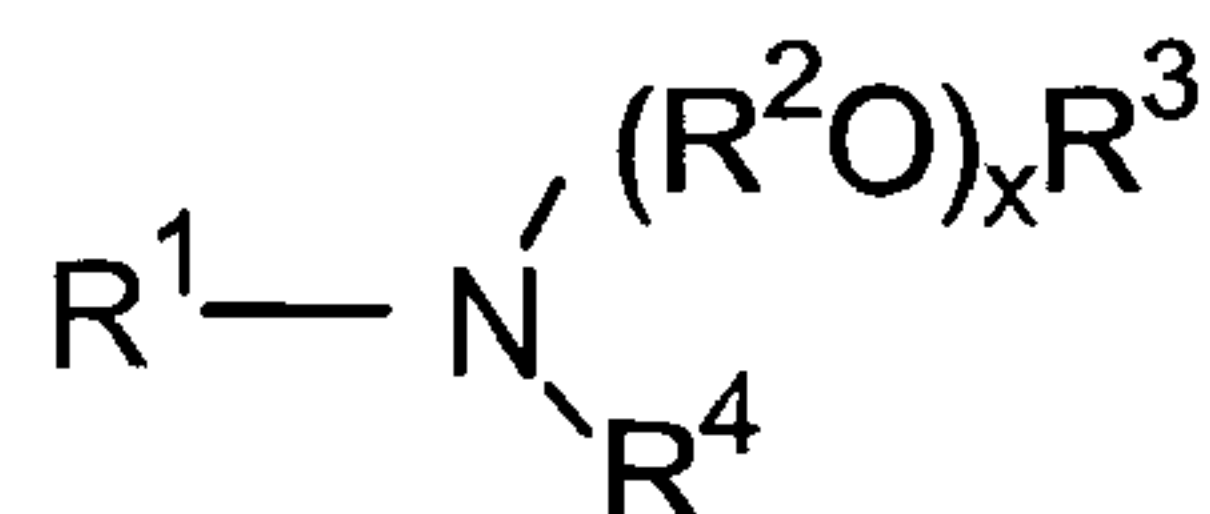

(30)

wherein R^1 is a hydrocarbyl or substituted hydrocarbyl group
 having from 1 to about 30 carbon atoms, R^2 is C_2-C_4 alkylene,
 R^3 is hydrogen, or a linear or branched alkyl group having
 25 from 1 to about 4 carbon atoms, R^4 is a linear or branched
 alkynyl, aryl, or aralkyl group having from 1 to about 30

64725-903 (D)

10ee

carbon atoms, and x is an average number from 1 to about 60;

(f) amine oxides having the formula:

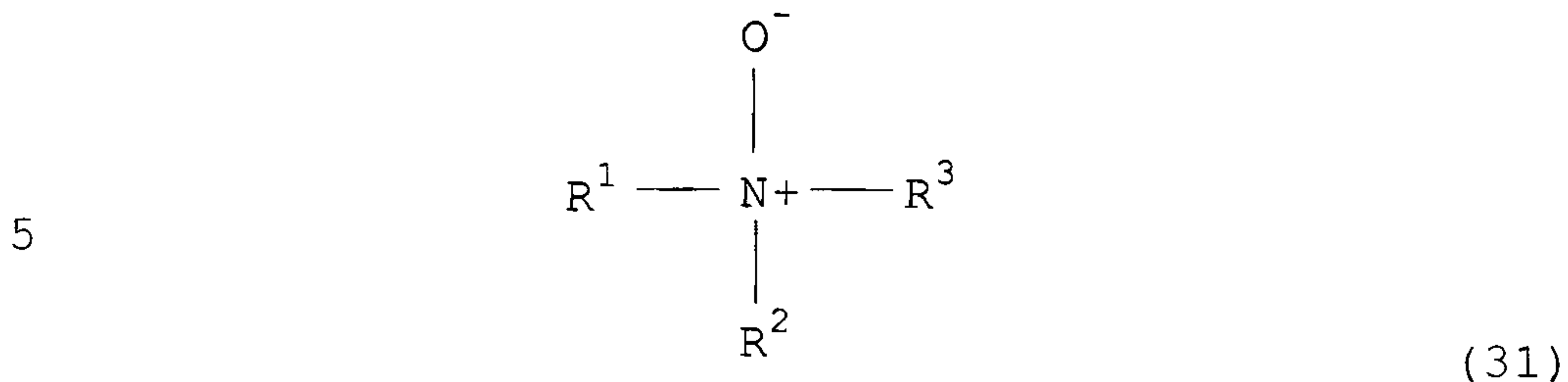

wherein R¹ is hydrocarbyl or substituted hydrocarbyl having from about 8 to about 30 carbon atoms, R² and R³ are independently -(R⁴O)_xR⁵, R⁴ in each of the x (R⁴O) groups is independently C₂-C₄ alkylene, R⁵ is hydrogen, or a hydrocarbyl or substituted hydrocarbyl having from 1 to about 30 carbon atoms, x is an average number from 1 to about 50; (g) an alkoxyated amine oxide having the formula:

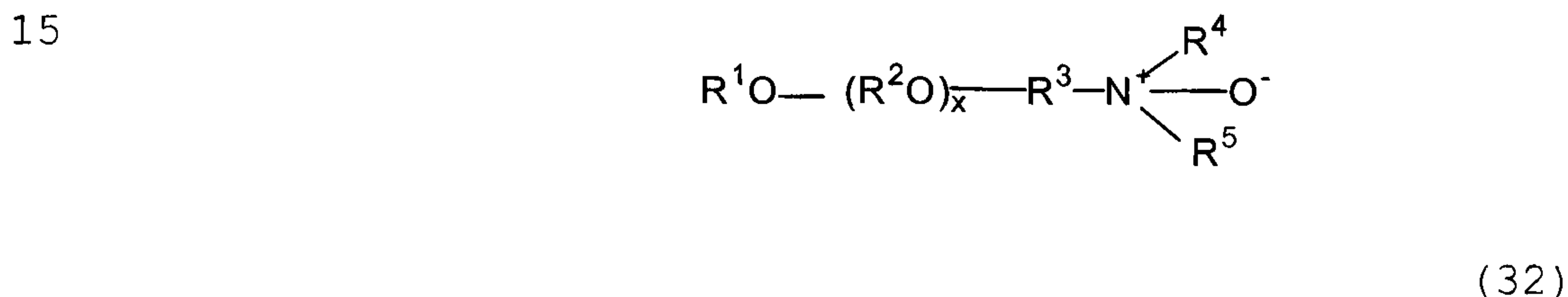

wherein R¹ is hydrogen or hydrocarbyl or substituted hydrocarbyl having from 1 to about 30 carbon atoms; R² in each of the x (R²O) and y (R²O) groups is independently C₂-C₄ alkylene; R³ is a hydrocarbylene or substituted hydrocarbylene having from 2 to about 6 carbon atoms; R⁴ and R⁵ are each independently hydrogen, hydrocarbyl or substituted hydrocarbyl having from 1 to about 30 carbon atoms, -(R⁶)_n-(R²O)_yR⁷; R⁶ is hydrocarbylene or substituted hydrocarbylene containing from 1 to about 6 carbon atoms, R⁷ is hydrogen or a linear or branched alkyl group having 1 to about 4 carbon atoms, n is 0 or 1, and x and y are

64725-903(D)

10ff

independently an average number from 1 to about 60; (h) alkoxyated diamines having the formula:

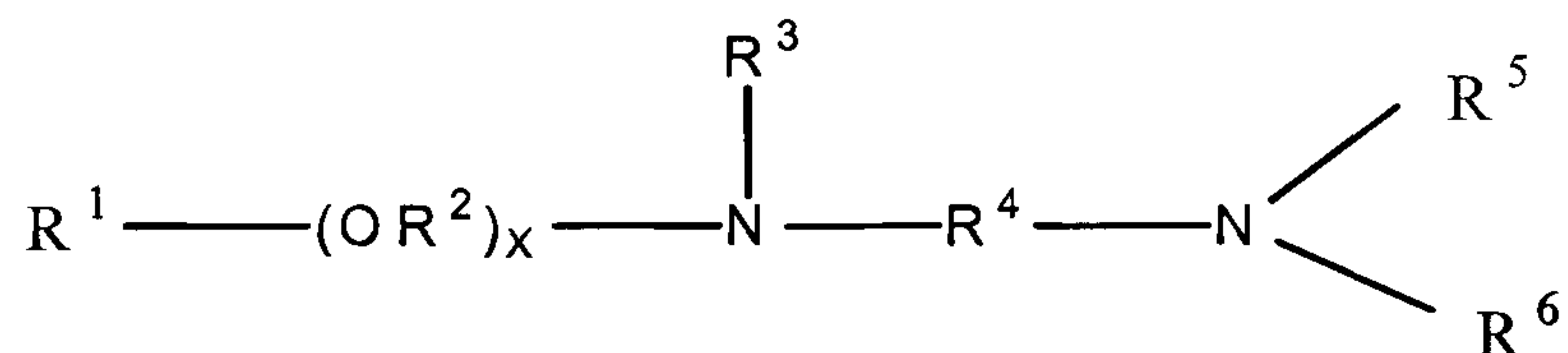

(33)

wherein R^1 is hydrocarbyl or substituted hydrocarbyl having from about 8 to about 30 carbon atoms; R^2 in each of the x (R^2O) groups and the y (R^2O) groups is independently C_2-C_4 alkyene; R^3 , R^5 and R^6 are independently hydrogen, hydrocarbyl or substituted hydrocarbyl having from 1 to about 30 carbon atoms, or $-(R^2O)_yR^7$; R^4 is hydrocarbylene or substituted hydrocarbylene having from 2 to about 6 carbon atoms, $-C(=NR^{11})NR^{12}R^{13}-$, $-C(=O)NR^{12}R^{13}-$, $-C(=S)NR^{12}R^{13}-$, $-C(=NR^{12})-$, $-C(S)-$, or $-C(O)-$; R^7 is hydrogen, or a linear or branched alkyl group having from 1 to about 4 carbon atoms; R^{11} , R^{12} and R^{13} are hydrogen, hydrocarbyl or substituted hydrocarbyl having from 1 to about 30 carbon atoms, x is an average number from 1 to about 30; and y is an average number from 1 to about 50, provided, however, that at least one of R^3 , R^5 and R^6 is $-(R^2O)_yR^7$, at least one R^2 is other than ethylene, R^4 is other than unsubstituted propylene, R^1 is other than unsubstituted alkyl, or x is from 2 to about 30; (i) dialkoxyated amines having the formula:

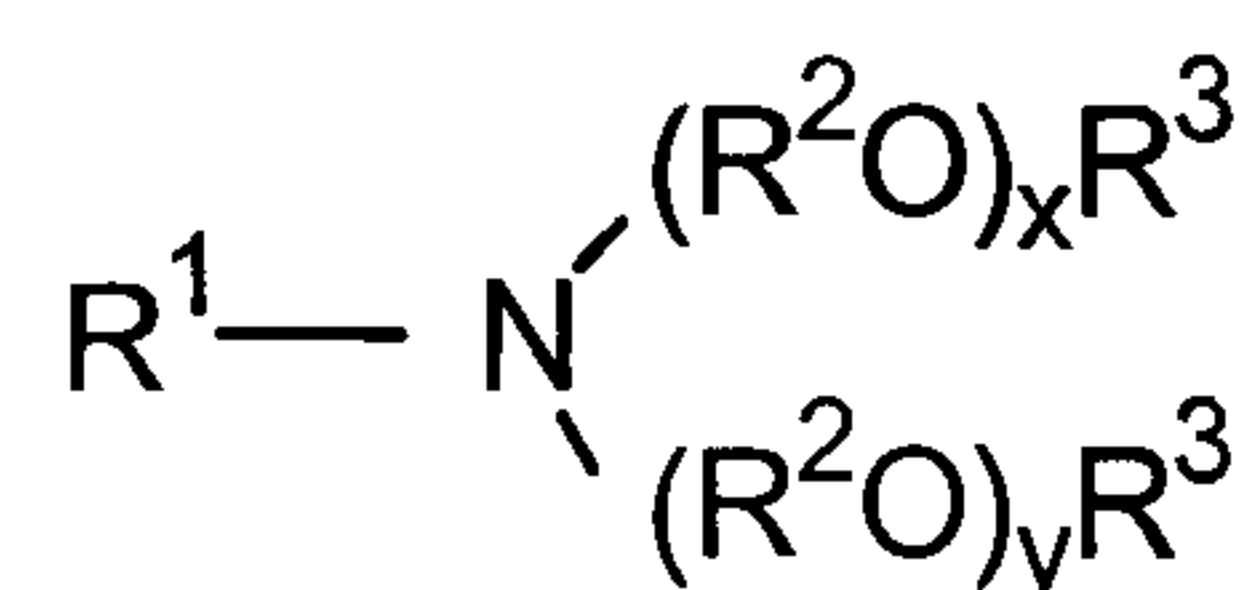

(34)

64725-903(D)

10gg

wherein R^1 is a hydrocarbyl or substituted hydrocarbyl having from about 6 to about 30 carbon atoms, or $-R^4SR^5$, R^4 and R^5 in each of the x (R^2O) and the y (R^2O) groups is independently C_2-C_4 alkylene, R^3 is hydrogen, or a linear or branched alkyl group having from 1 to about 4 carbon atoms, R^5 is a linear or branched alkyl group having from about 4 to about 15 carbon atoms, and x and y are independently an average number from 1 to about 40; (j) dialkoxylated alcohols having the formula:

10

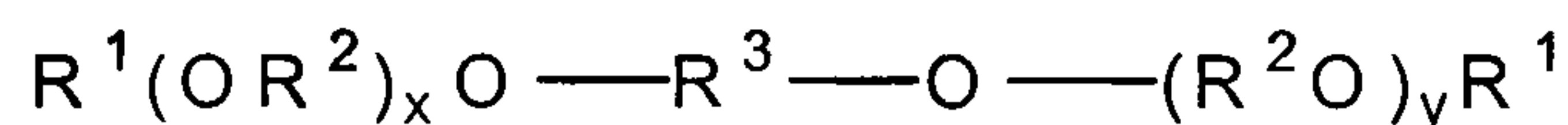

(35)

wherein R^1 is independently hydrogen, or a linear or branched alkyl group having from 1 to about 4 carbon atoms, R^2 in each of the x (R^2O) and the y (R^2O) groups is independently C_2-C_4 alkylene, R^3 is hydrocarbylene or substituted hydrocarbylene having from 2 to about 30 carbon atoms, and x and y are independently an average number from 1 to about 60; and (k) compounds of the formula:

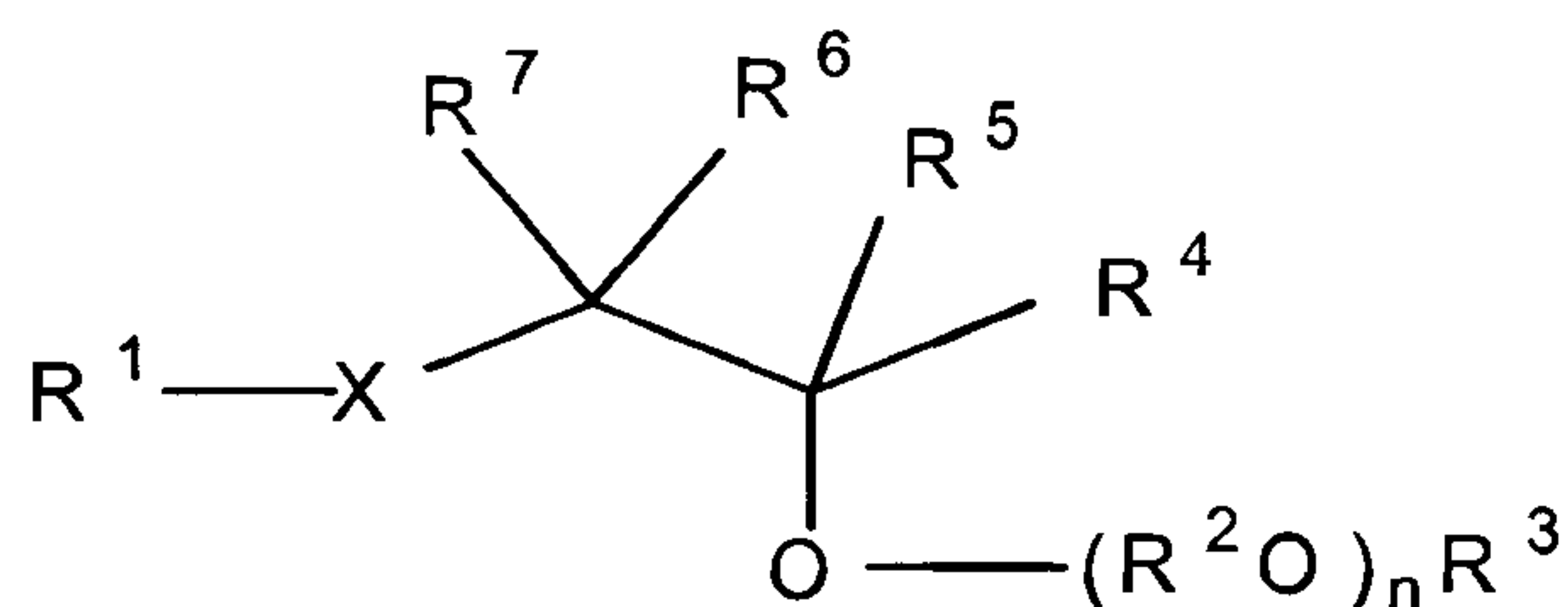

(36)

or

64725-903 (D)

10hh

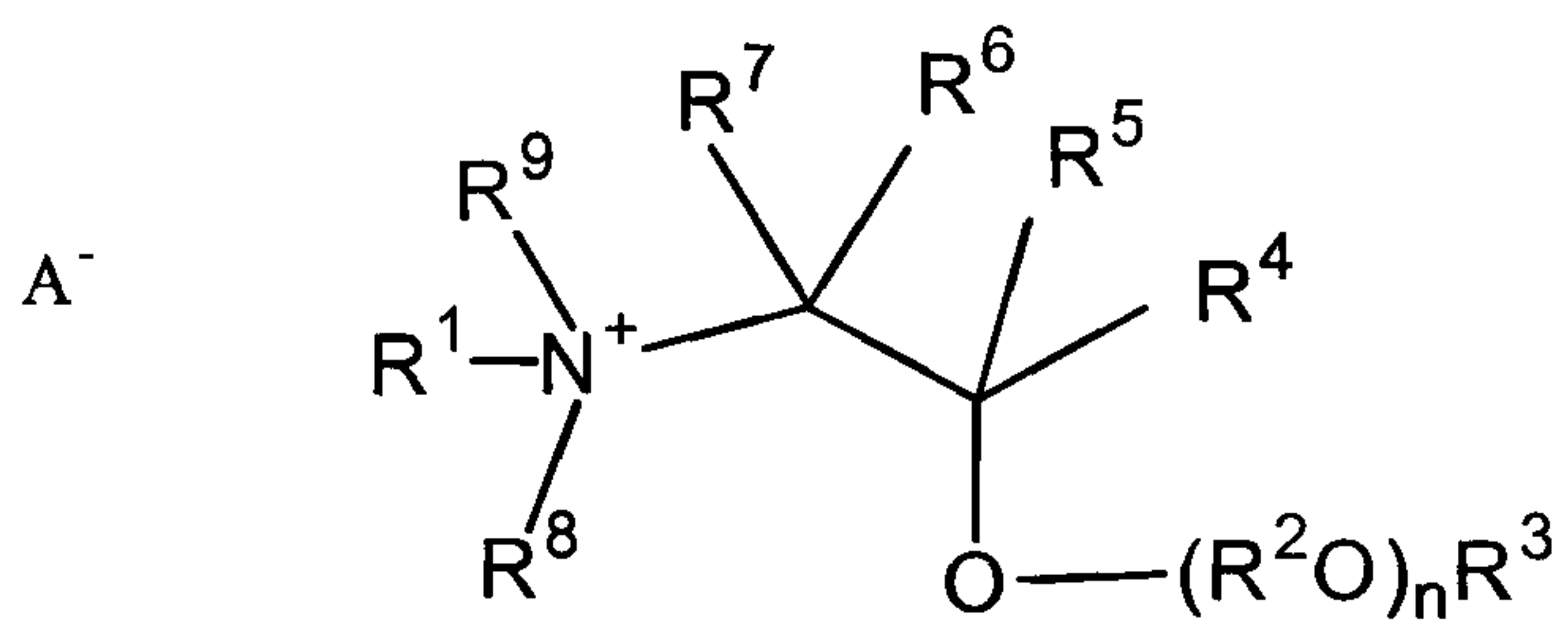

(37)

or

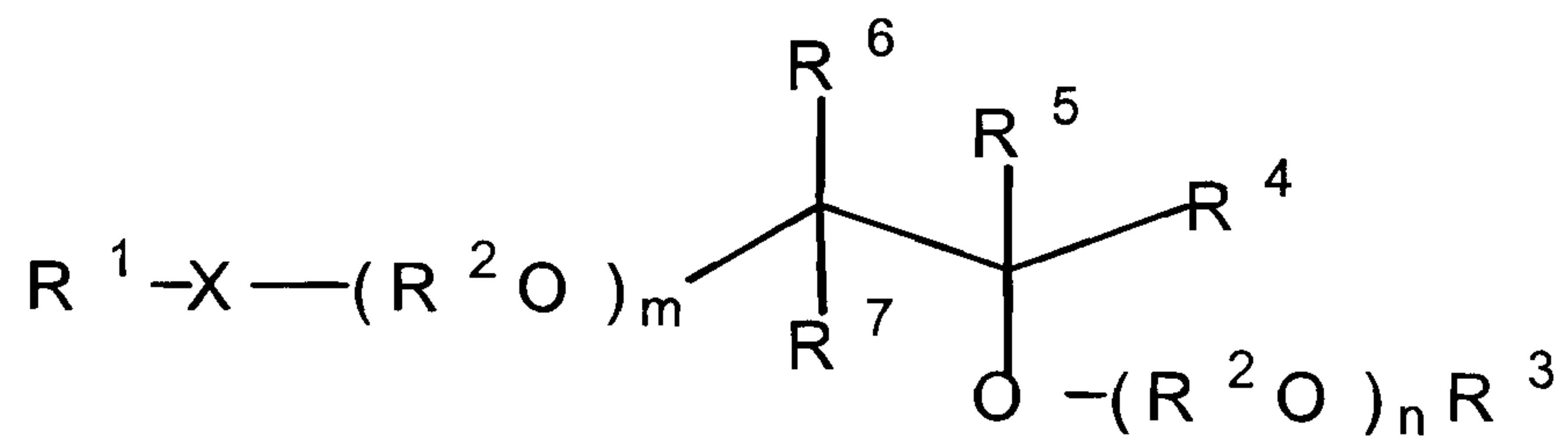

(38)

or

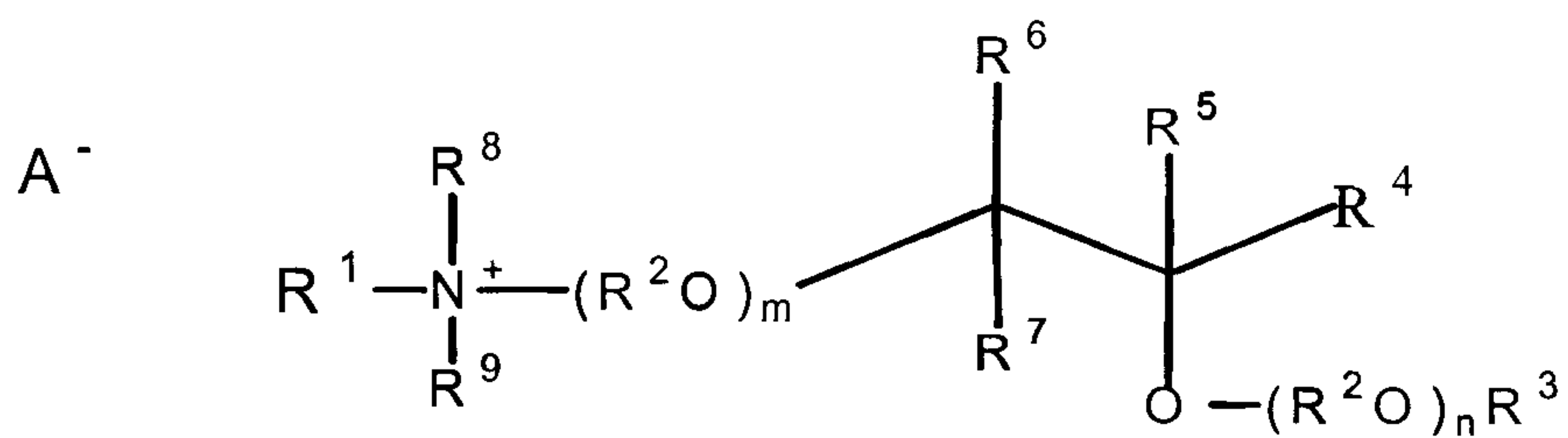

5

(39)

or

64725-903 (D)

10ii

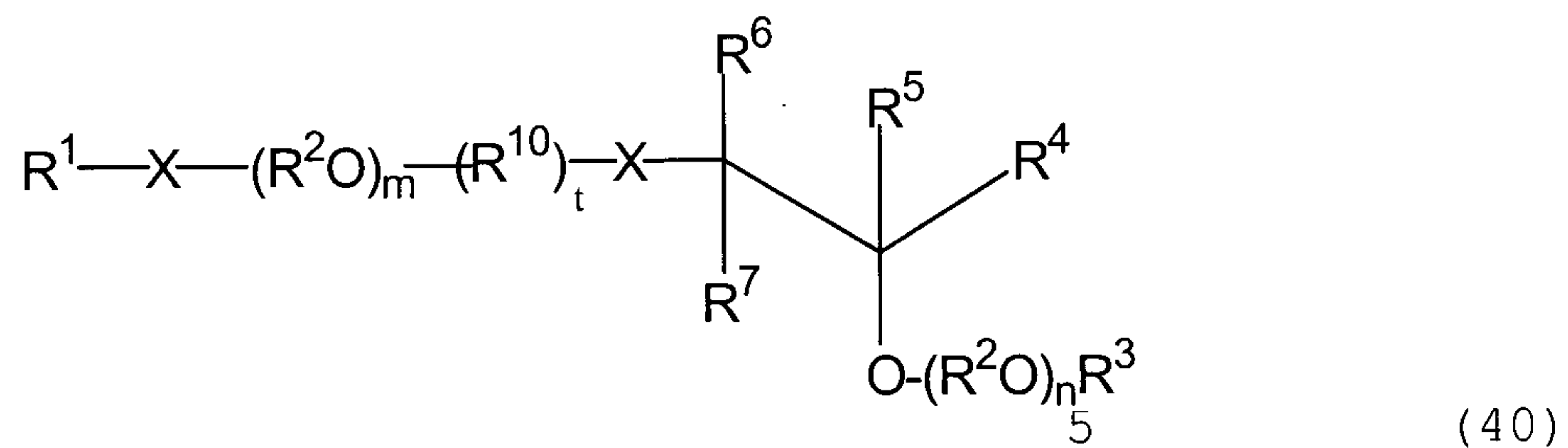

or

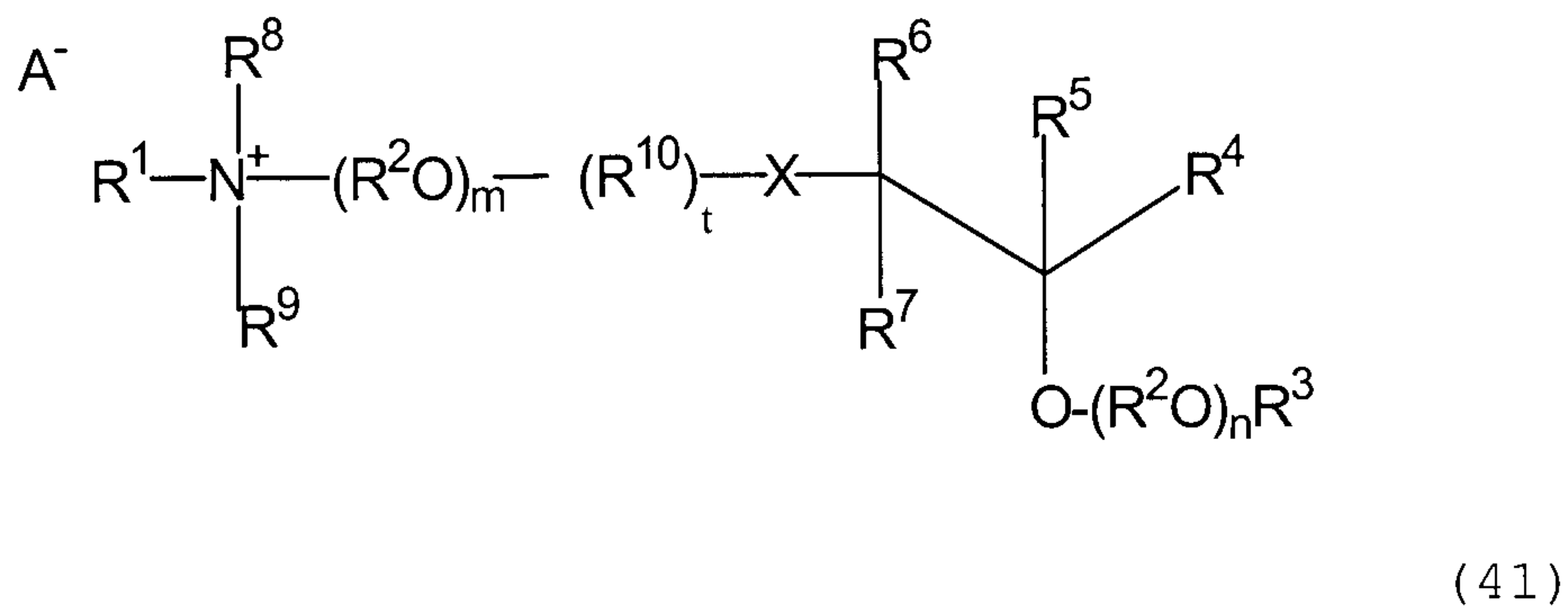

or

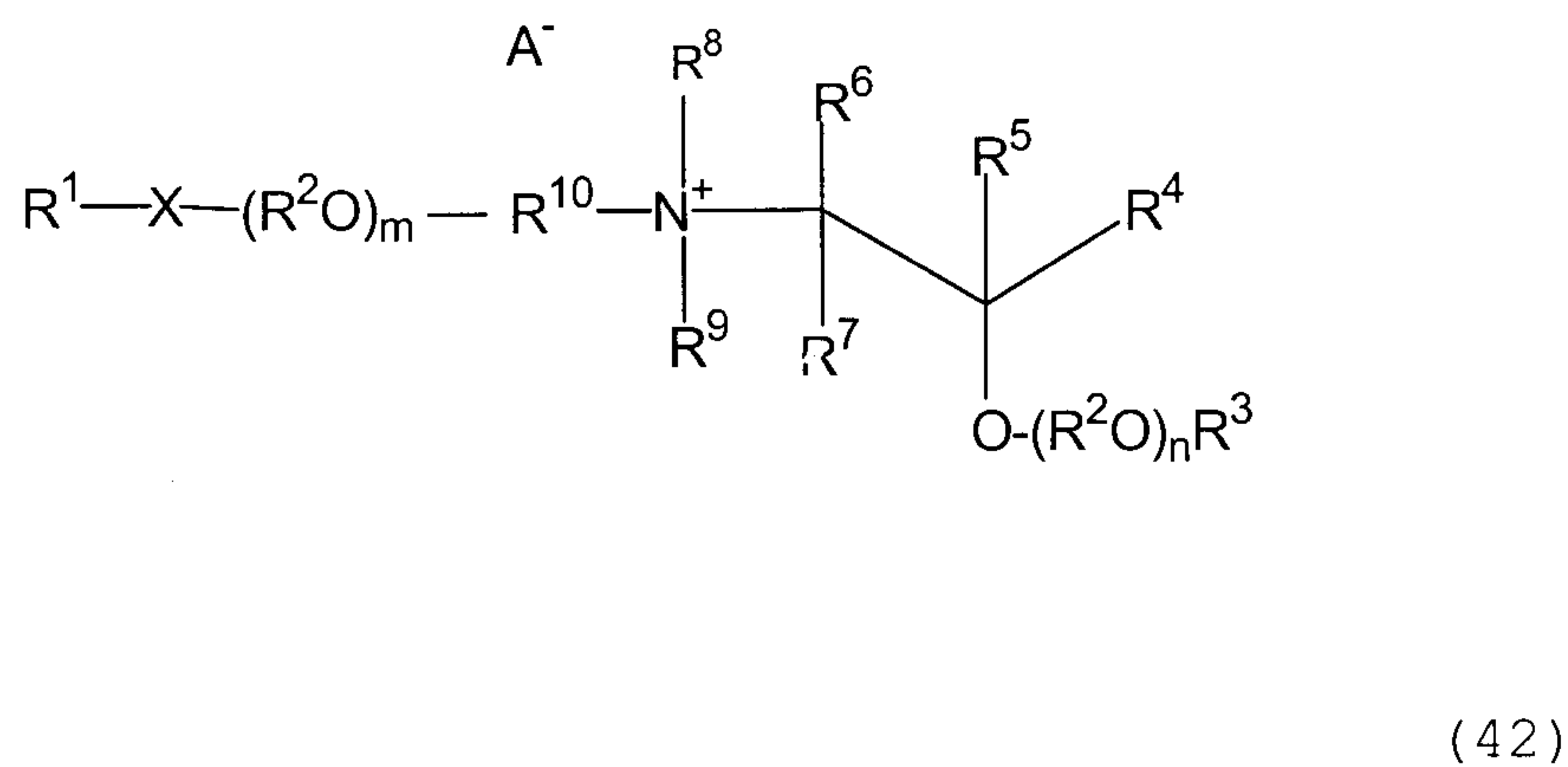

or

64725-903 (D)

10jj

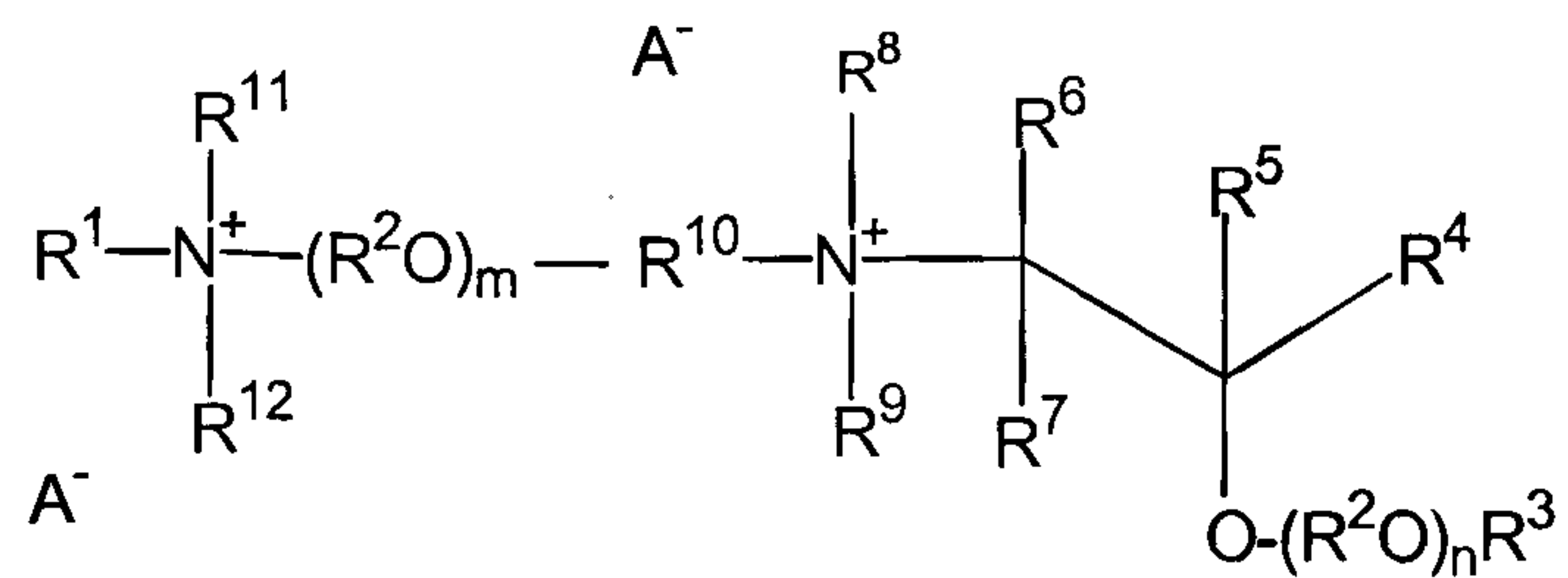

(43)

wherein R^1 , R^9 , and R^{12} are independently hydrocarbyl or substituted hydrocarbyl having from 1 to about 30 carbon atoms, or $-(\text{R}^2\text{O})_p\text{R}^{13}$; R^2 in each of the m (R^2O) , n (R^2O) , p (R^2O) and q (R^2O) groups is independently C_2 - C_4 alkylene;

5 R^3 , R^8 , R^{11} , R^{13} and R^{15} are independently hydrogen, or a hydrocarbyl or substituted hydrocarbyl having from 1 to about 30 carbon atoms; R^4 is $-(\text{CH}_2)_y\text{OR}^{13}$ or $-(\text{CH}_2)_y\text{O}(\text{R}^2\text{O})_q\text{R}^3$; R^5 , R^6 and R^7 are independently hydrogen, hydrocarbyl or substituted hydrocarbyl having from 1 to about 30 carbon

10 atoms, or R^4 ; R^{10} is hydrocarbylene or substituted hydrocarbylene having from 2 to about 30 carbon atoms; R^{14} is hydrocarbyl or substituted hydrocarbyl having from 1 to about 30 carbon atoms, or $-(\text{CH}_2)_z\text{O}(\text{R}^2\text{O})_p\text{R}^3$; m , n , p and q are independently an average number from 1 to about 50; X is

15 $-\text{O}-$, $-\text{N}(\text{R}^{14})-$, $-\text{C}(\text{O})-$, $-\text{C}(\text{O})\text{O}-$, $-\text{OC}(\text{O})-$, $-\text{N}(\text{R}^{15})\text{C}(\text{O})-$, $-\text{C}(\text{O})\text{N}(\text{R}^{15})-$, $-\text{S}-$, $-\text{SO}-$, or $-\text{SO}_2-$; t is 0 or 1; A^- is an agriculturally acceptable anion; and y and z are independently an integer from 0 to about 30.

According to another aspect of the invention of

20 the present divisional application, there is provided a surfactant compound selected from the group consisting of:

(a) monoalkoxylated amines having the formula:

64725-903 (D)

10kk

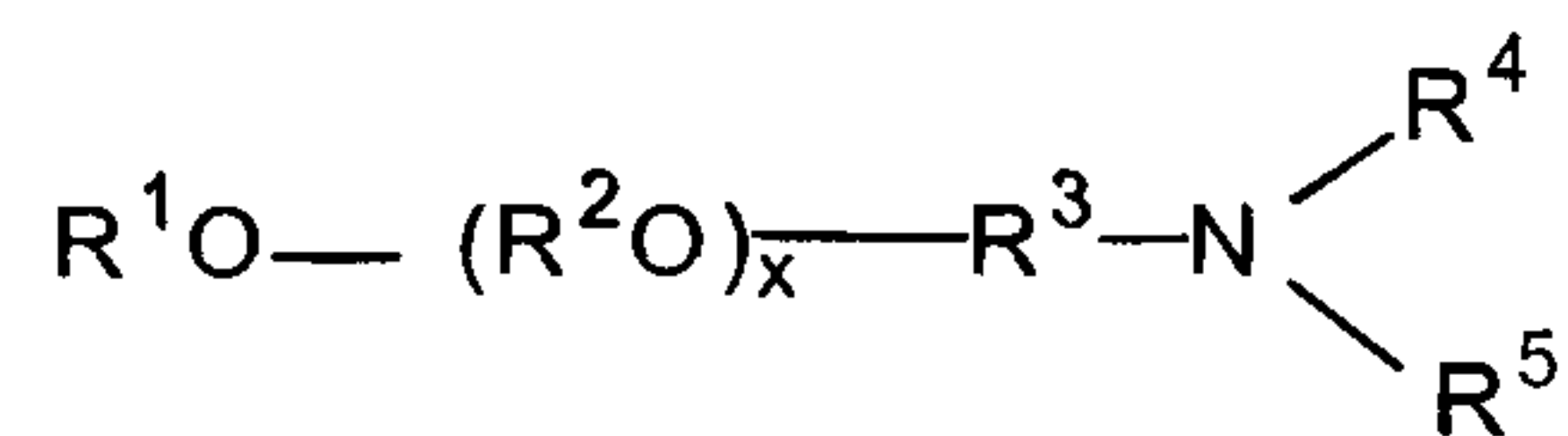

(23)

- 5 wherein R¹ is hydrogen or hydrocarbyl or substituted hydrocarbyl having at least 7 carbon atoms; R² in each of the (R²O)_x and (R²O)_y groups is independently C₂-C₄ alkylene; R³ is a hydrocarbylene or substituted hydrocarbylene having from 2 to about 6 carbon atoms; R⁴ and R⁵ are each independently
- 10 hydrogen, hydrocarbyl or substituted hydrocarbyl having from 1 to about 30 carbon atoms, -(R⁶)_n-(R²O)_yR⁷, or R⁴ and R⁵, together with the nitrogen atom to which they are attached, form a cyclic or heterocyclic ring; R⁶ is hydrocarbylene or substituted hydrocarbylene containing from 1 to about 6
- 15 carbon atoms, R⁷ is hydrogen or a linear or branched alkyl group having 1 to about 4 carbon atoms, n is 0 or 1, and x and y are independently an average number from 1 to about 60, provided, however, that when R² and R³ in each of the (R²O)_x groups is ethylene, R¹ is other than unsubstituted
- 20 alkyl or R⁴ is other than hydrogen or unsubstituted alkyl when R⁵ is hydrogen or unsubstituted alkyl, and when R² and R³ are isopropylene and x is 1, R¹ is other than unsubstituted alkyl or R⁴ is other than -(R²O)_yR⁷;
- (b) alkoxyated poly(hydroxyalkyl)amines having the
- 25 formula:

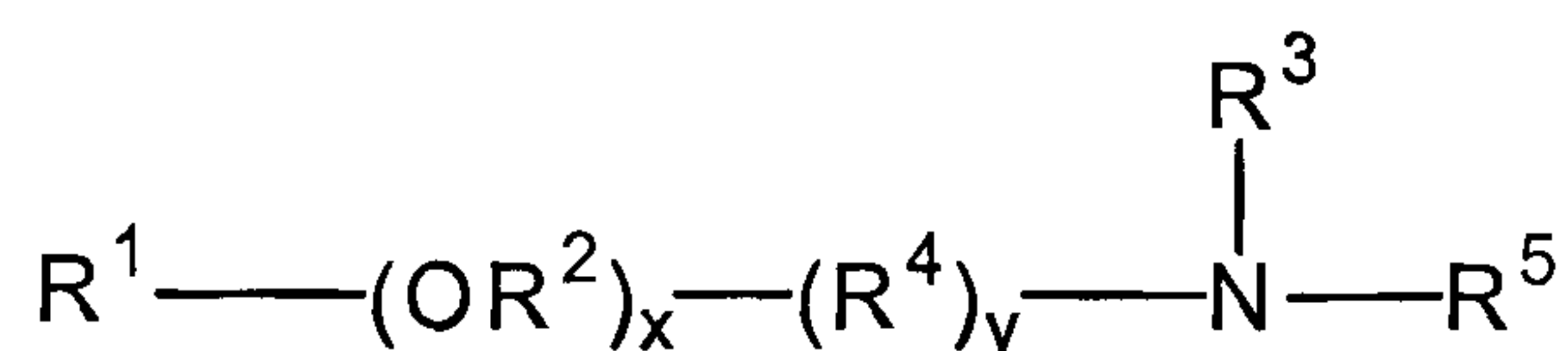

(24)

64725-903 (D)

1011

wherein R^1 and R^3 are independently hydrogen, hydrocarbyl or substituted hydrocarbyl having from 1 to about 30 carbon atoms, R^2 in each of the $(R^2O)_x$ groups is independently C_2-C_4 alkylene; R^4 is hydrocarbylene or substituted hydrocarbylene having from 1 to about 30 carbon atoms, R^5 is hydroxyalkyl, polyhydroxyalkyl, or poly(hydroxyalkyl)alkyl; x is an average number from 0 to about 30, and y is 0 or 1; (c) dipoly(hydroxyalkyl)amines having the formula:

10

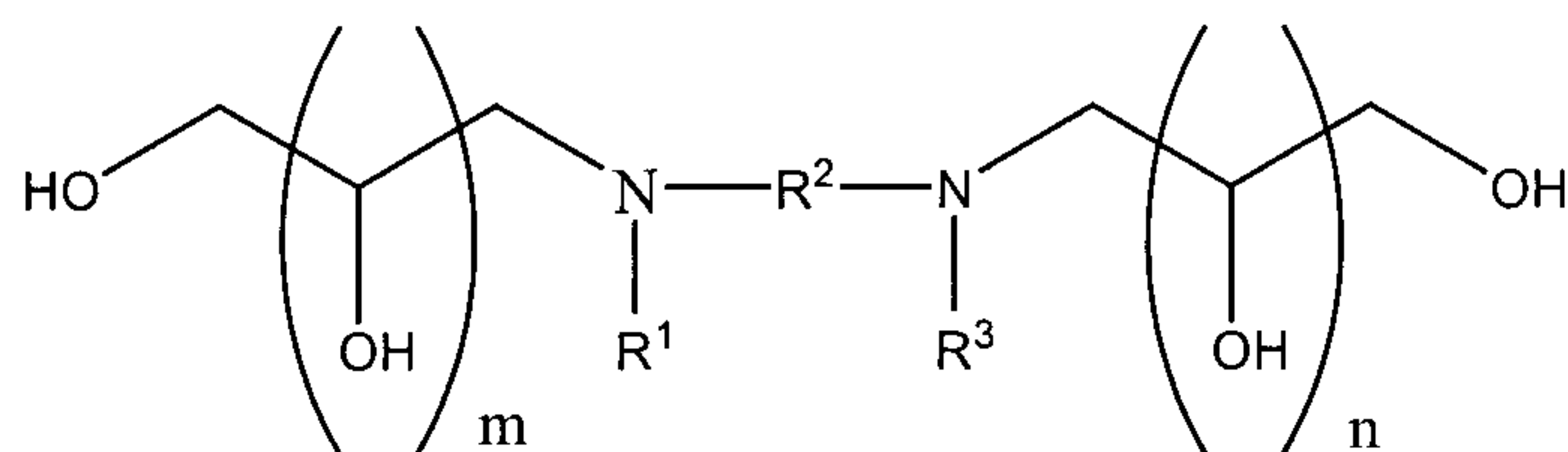

(28)

wherein R^1 and R^3 are independently hydrogen or hydrocarbyl or substituted hydrocarbyl having from 1 to about 22 carbon atoms, R^2 is hydrocarbylene or substituted hydrocarbylene having from 2 to about 18 carbon atoms, and m and n are independently integers from 1 to about 8, provided, however, that when R^1 and R^3 are methyl, R^2 is other than octylene; (d) alkoxyated triamines having the formula:

20

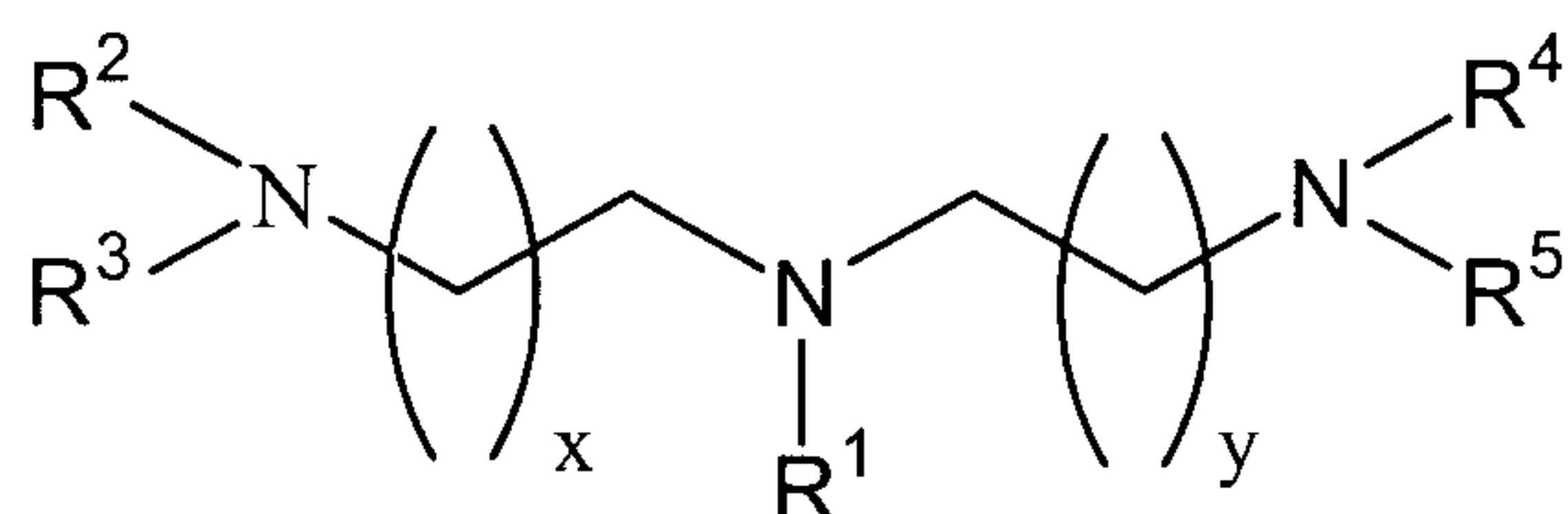

(29)

64725-903 (D)

10mm

wherein R^1 is hydrocarbyl or substituted hydrocarbyl having from 1 to about 30 carbon atoms; R^2 , R^3 , R^4 and R^5 are independently hydrogen, hydrocarbyl or substituted hydrocarbyl having from 1 to about 30 carbon atoms, or $-(R^8)_s$,
 5 $(R^7-O)_nR^6$; R^6 is hydrogen, or a linear or branched alkyl group having from 1 to about 4 carbon atoms; R^7 in each of the n (R^7O) groups is independently C_2-C_4 alkylene; R^8 is hydrocarbylene or substituted hydrocarbylene having from 1 to about 6 carbon atoms; n is an average number from 1 to
 10 about 10; s is 0 or 1; and x and y are independently an integer from 1 to about 4; provided, however, that when R^1 is alkyl, R^2 is other than hydrogen, x is 3 or 4, or R^4 is other than $-(R^7-O)_nR^6$; (e) monoalkoxylated amines having the formula:

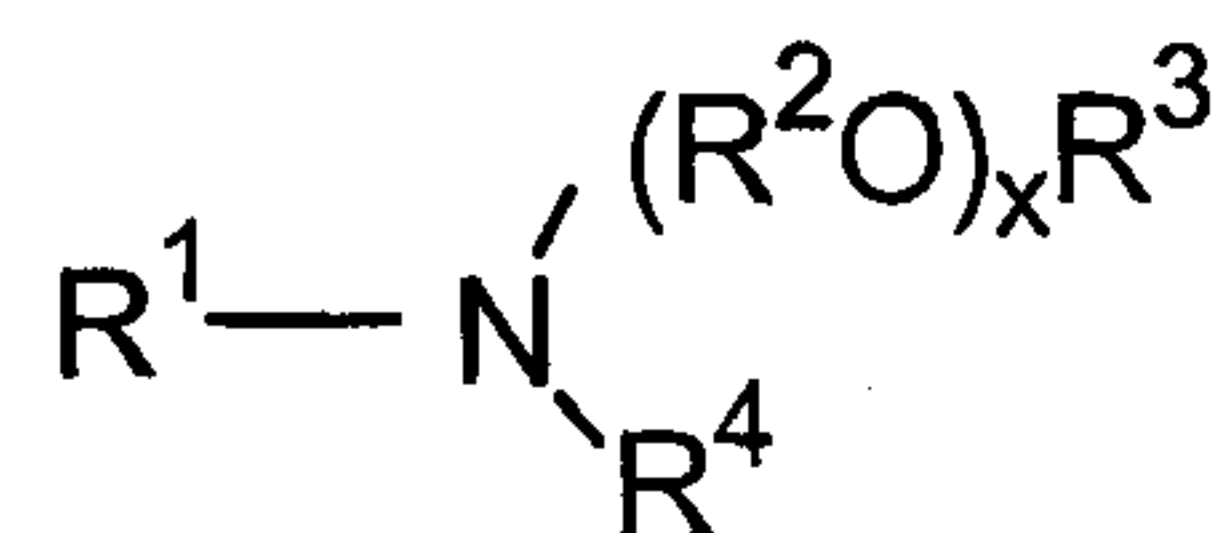

(30)

wherein R^1 is a hydrocarbyl or substituted hydrocarbyl group having from 1 to about 30 carbon atoms, R^2 is C_2-C_4 alkylene,
 20 R^3 is hydrogen, or a linear or branched alkyl group having from 1 to about 4 carbon atoms, R^4 is a linear or branched alkynyl, aryl, or aralkyl group having from 1 to about 30 carbon atoms, and x is an average number from 1 to about 60;
 (f) amine oxides having the formula:

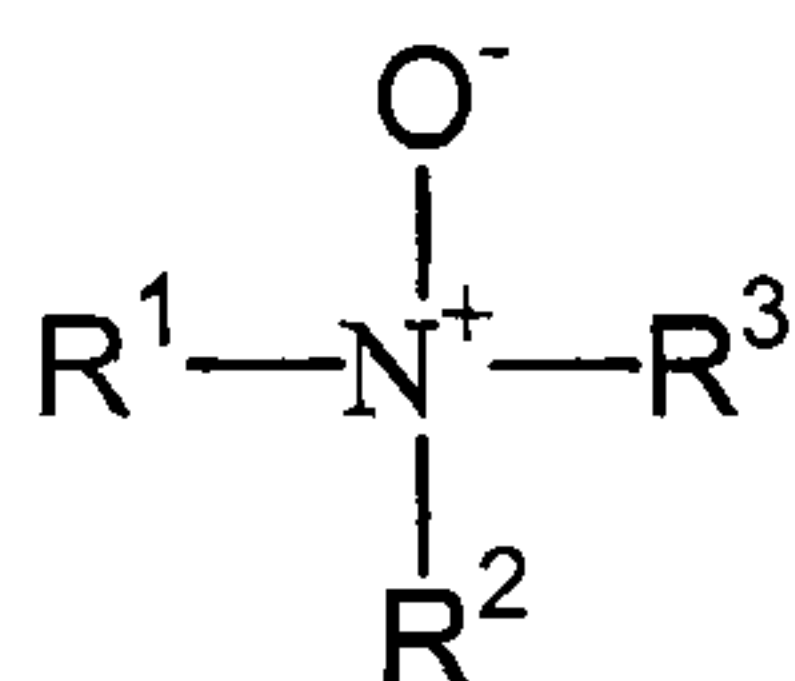

(31)

25

64725-903(D)

10nn

wherein R¹ is hydrocarbyl having from about 8 to about 30 carbon atoms, R² and R³ are independently -(R⁴O)_xR⁵, R⁴ in each of the (R⁴O)_x groups is independently C₂-C₄ alkylene, R⁵ is hydrogen, or a hydrocarbyl or substituted hydrocarbyl having from 1 to about 30 carbon atoms, x is an average number from 1 to about 50; (g) an alkoxyated amine oxide having the formula:



(32)

wherein R¹ is hydrogen or hydrocarbyl or substituted hydrocarbyl having from 1 to about 30 carbon atoms; R² in each of the (R²O)_x and (R²O)_y groups is independently C₂-C₄ alkylene; R³ is a hydrocarbylene or substituted hydrocarbylene having from 2 to about 6 carbon atoms; R⁴ and R⁵ are each independently hydrogen, hydrocarbyl or substituted hydrocarbyl having from 1 to about 30 carbon atoms, -(R⁶)_n-(R²O)_yR⁷; R⁶ is hydrocarbylene or substituted hydrocarbylene containing from 1 to about 6 carbon atoms, R⁷ is hydrogen or a linear or branched alkyl group having 1 to about 4 carbon atoms, n is 0 or 1, and x and y are independently an average number from 1 to about 60; (h) alkoxyated diamines having the formula:

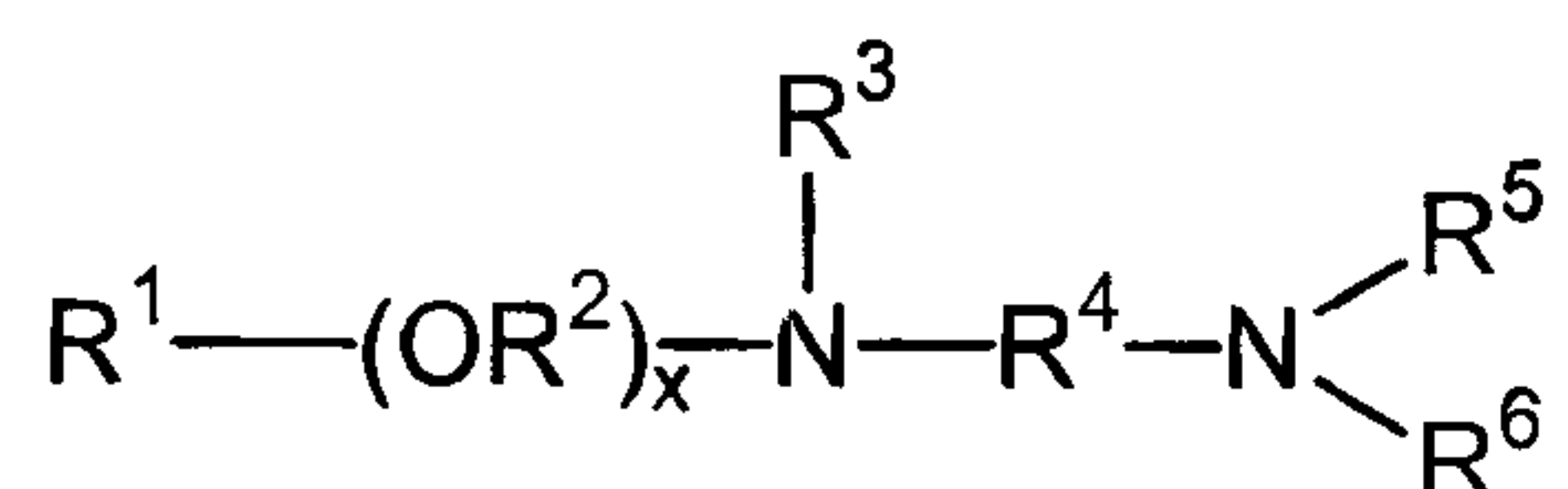

(33)

64725-903(D)

1000

wherein R^1 is hydrocarbyl or substituted hydrocarbyl having from about 8 to about 30 carbon atoms; R^2 in each of the $(R^2O)_x$ groups and the $(R^2O)_y$ groups is independently C_2-C_4 alkylene; R^3 , R^5 and R^6 are independently hydrogen, hydrocarbyl or substituted hydrocarbyl having from 1 to about 30 carbon atoms, or $-(R^2O)_yR^7$; R^4 is hydrocarbylene or substituted hydrocarbylene having from 2 to about 6 carbon atoms, $-C(=NR^{11})NR^{12}R^{13}-$, $-(=O)NR^{12}R^{13}-$, $-C(=S)NR^{12}R^{13}-$, $-C(=NR^{12})-$, $-C(S)-$, or $-C(O)-$; R^7 is hydrogen, or a linear or branched alkyl group having from 1 to about 4 carbon atoms; R^{11} , R^{12} and R^{13} are hydrogen, hydrocarbyl or substituted hydrocarbyl having from 1 to about 30 carbon atoms x is an average number from 1 to about 30; and y is an average number from 1 to about 50, provided, however, that at least one of R^3 , R^5 and R^6 is $-(R^2O)_yR^7$, at least one R^2 is other than ethylene, R^4 is other than unsubstituted propylene, R^1 is other than unsubstituted alkyl, or x is from 2 to about 30; (i) dialkoxylated amines having the formula:

20

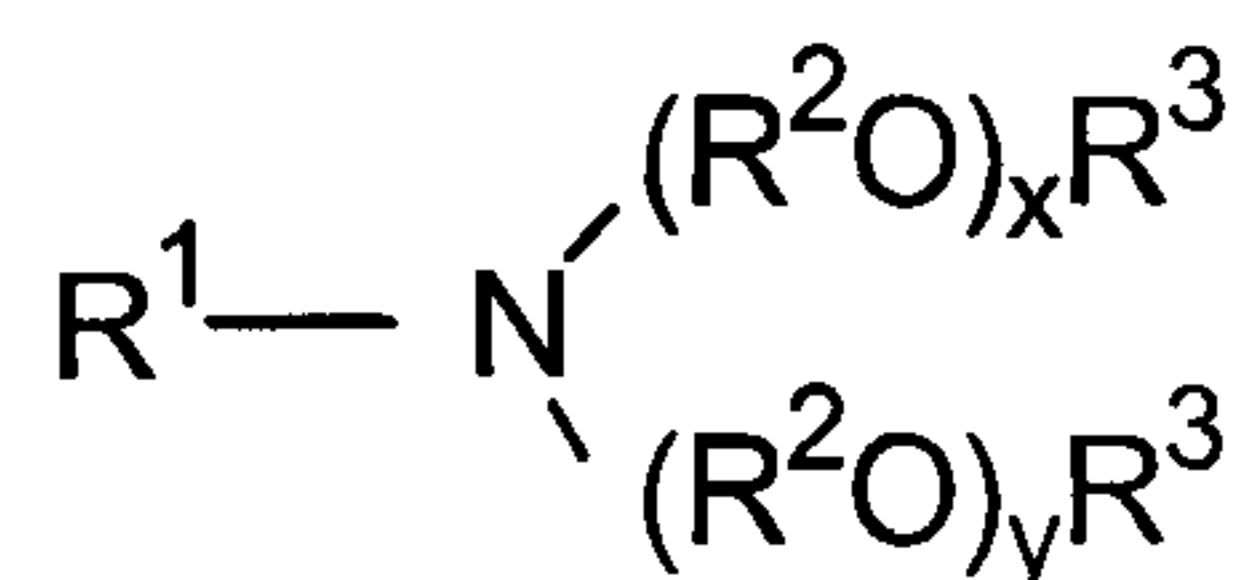

(34)

wherein (a) R^1 is a hydrocarbyl or substituted hydrocarbyl having from about 6 to about 30 carbon atoms, or $-R^4SR^5$, R^4 and R^2 in each of the $(R^2O)_x$ and the $(R^2O)_y$ groups is independently C_2-C_4 alkylene, R^3 is a linear or branched alkyl group having from 1 to about 4 carbon atoms, R^5 is a linear or branched alkyl group having from about 4 to about 15 carbon atoms, and x and y are independently an average number from 1 to about 40, or (b) wherein R^1 is $-R^4SR^5$, R^4 and R^2 in each of the $(R^2O)_x$ and the $(R^2O)_y$ groups is

64725-903 (D)

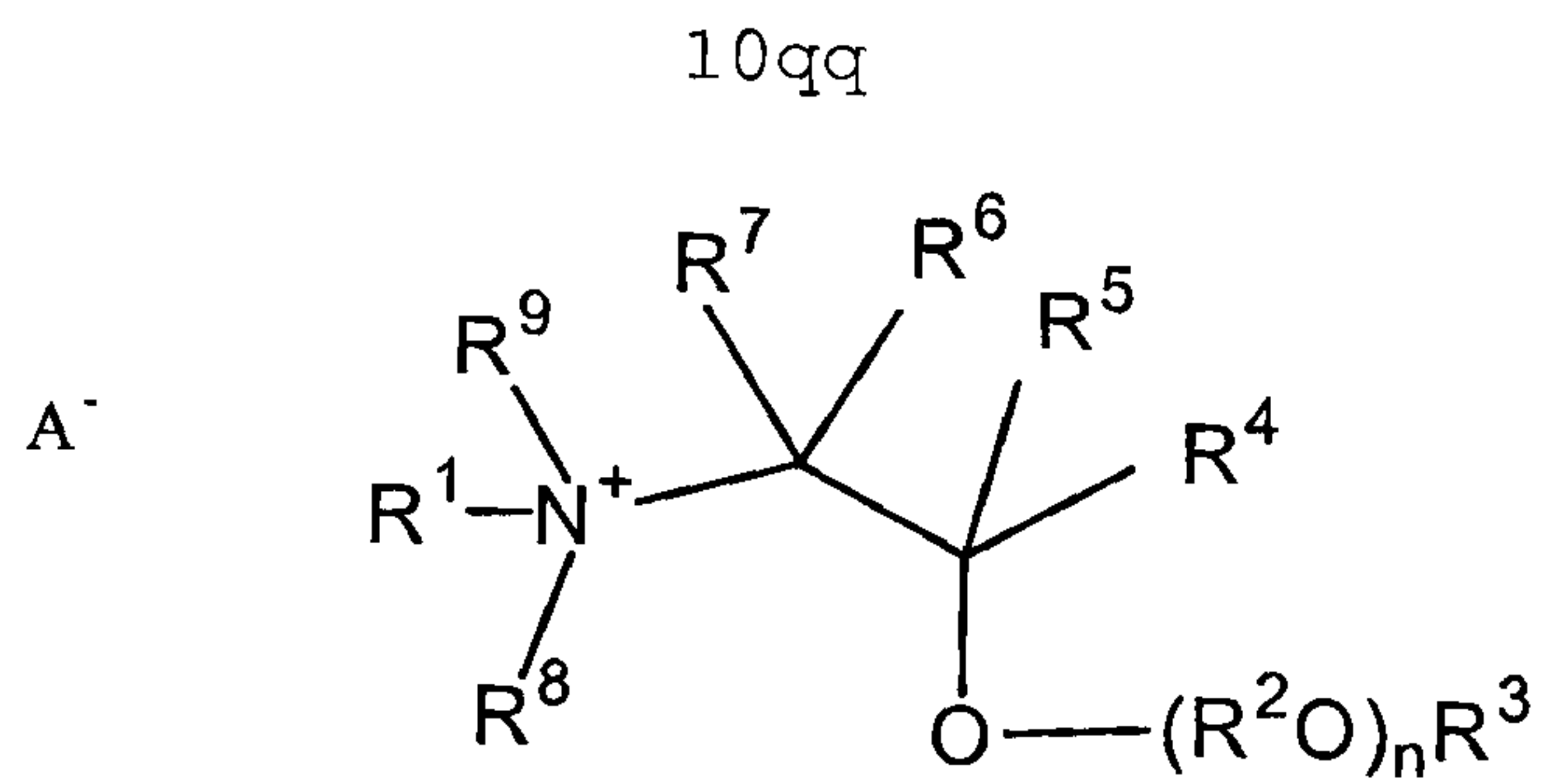

5

(37)

or

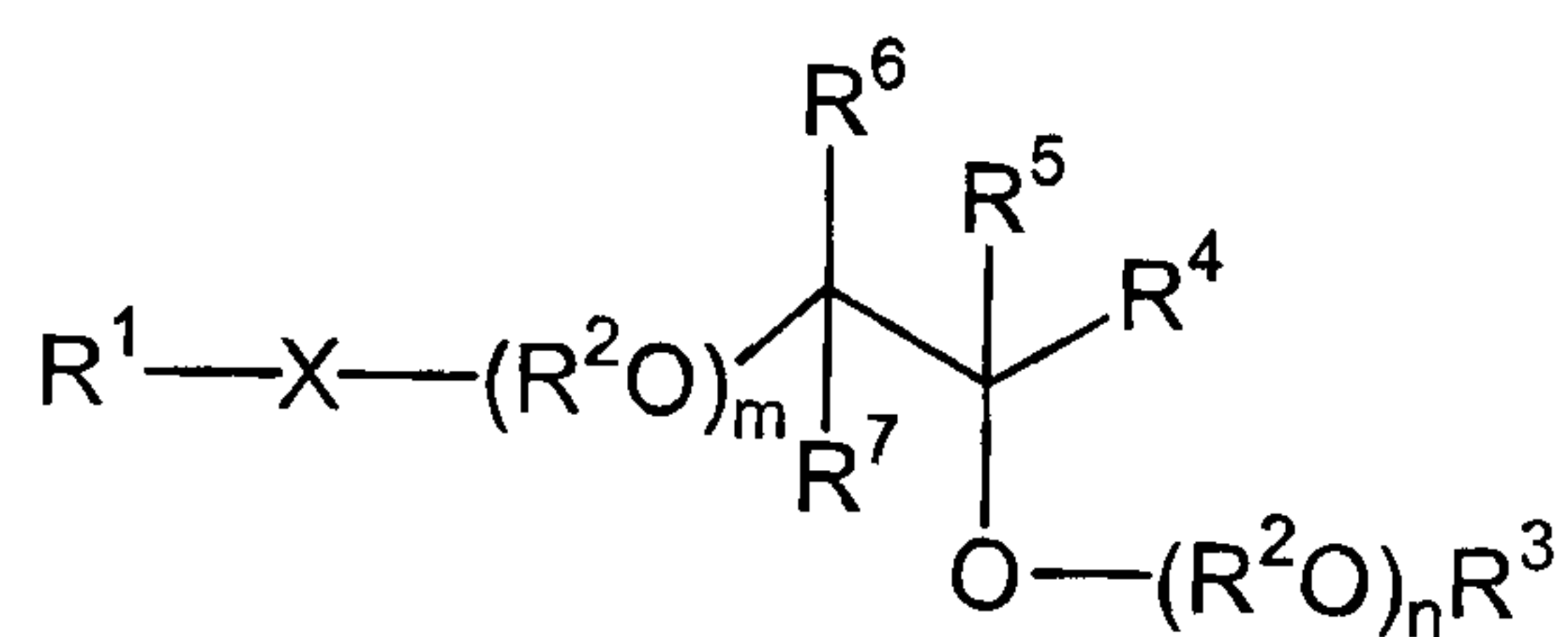

10

(38)

or

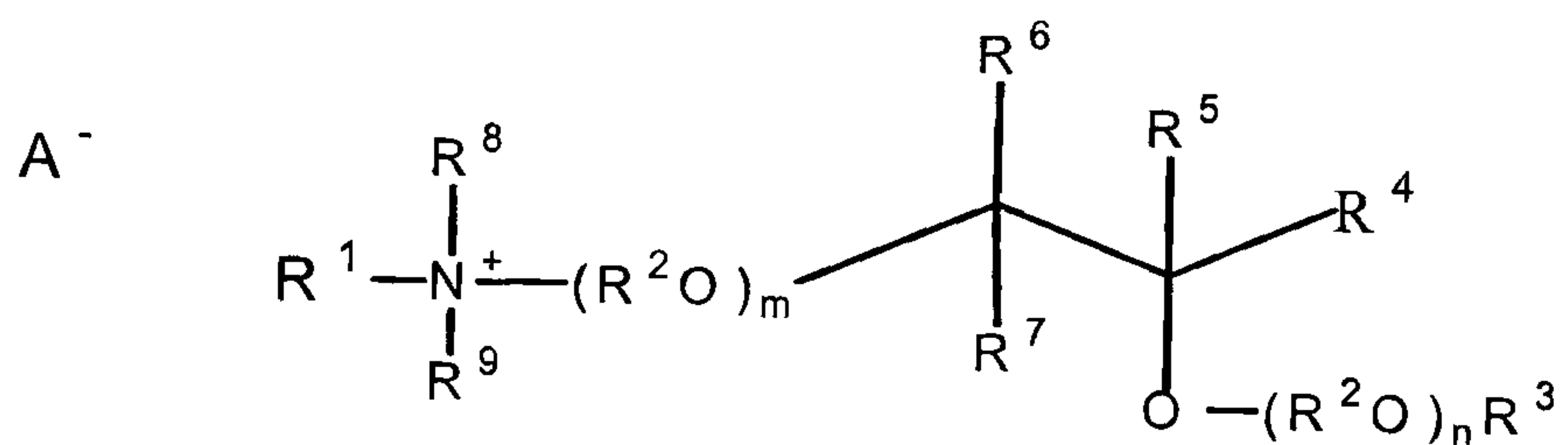

15

(39)

or

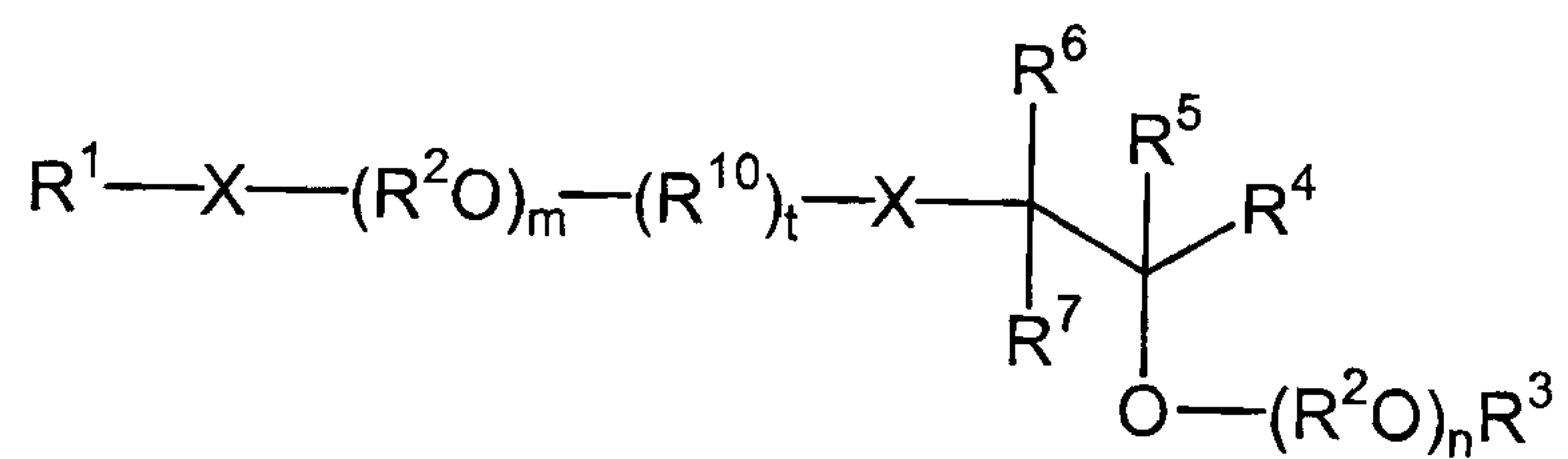

20

(40)

64725-903(D)

10rr

or

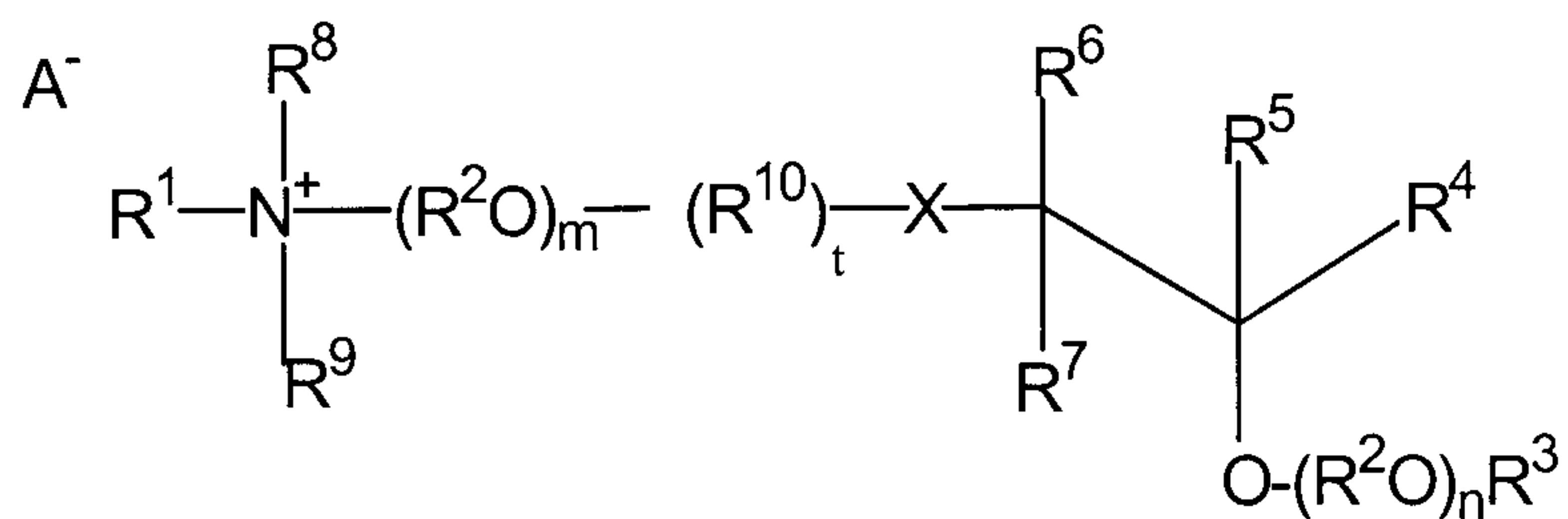

5

(41)

or

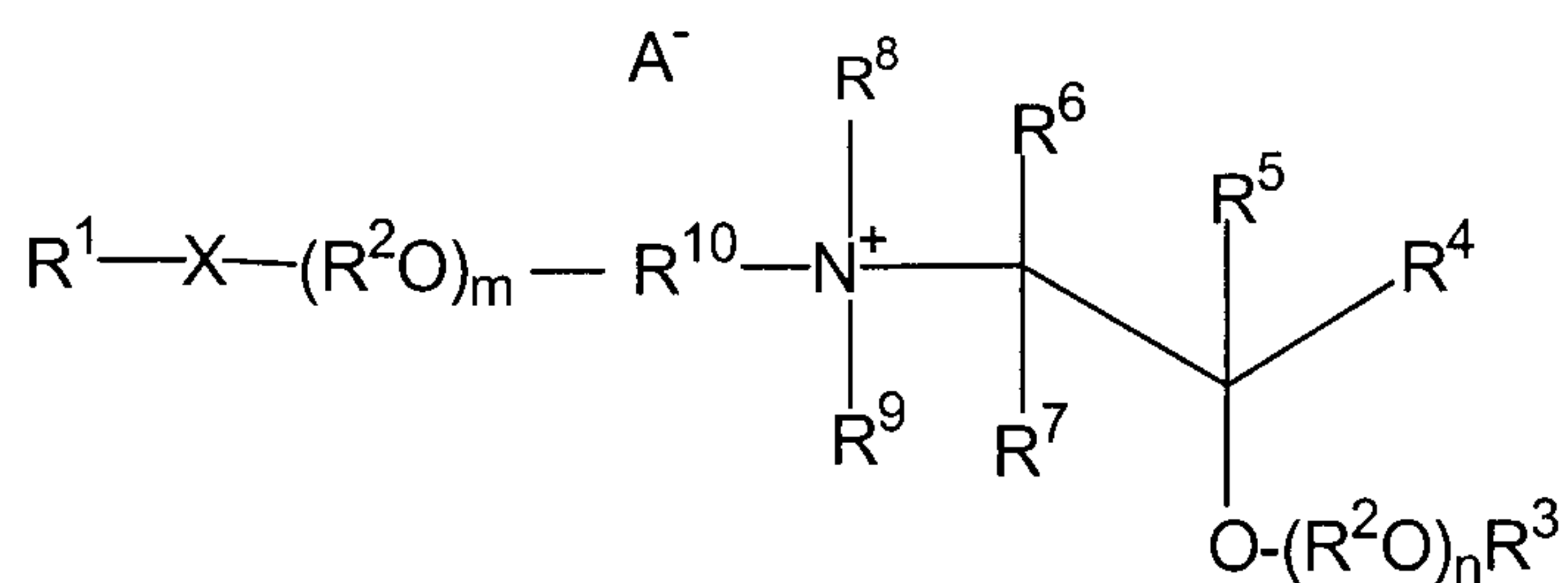

10

(42)

or

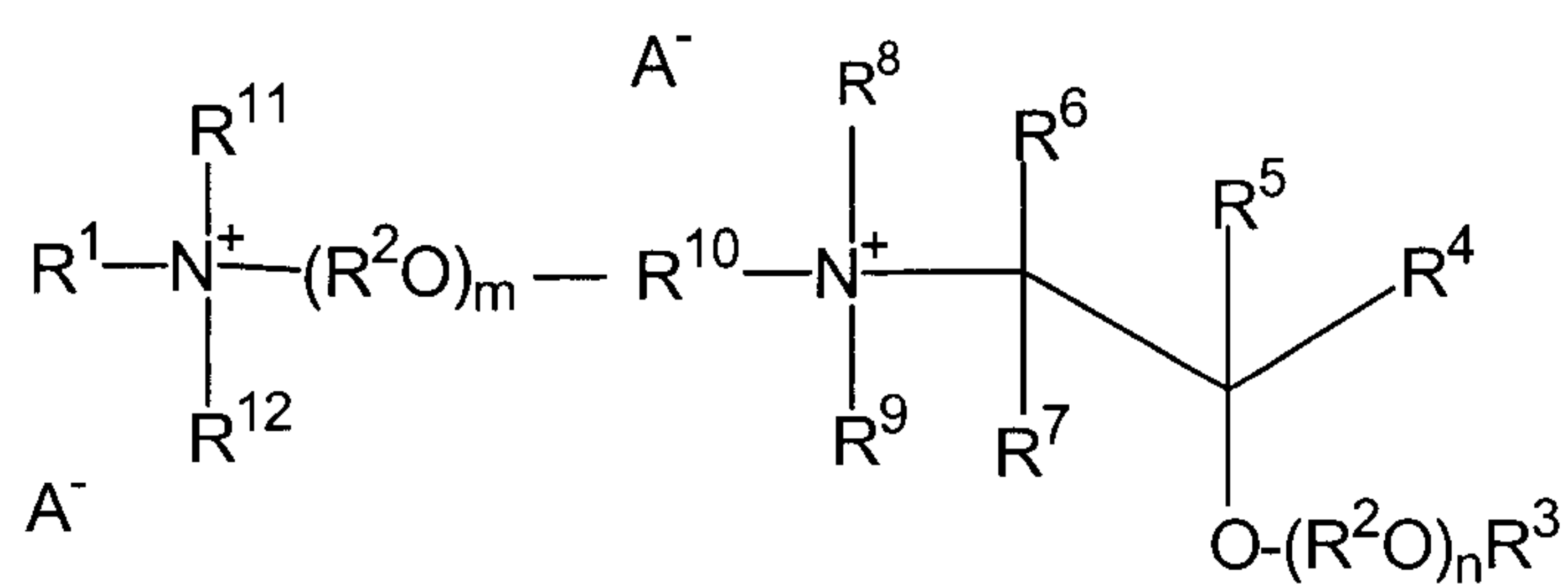

15

(43)

20 wherein R^1 , R^9 , and R^{12} are independently hydrocarbyl or substituted hydrocarbyl having from 1 to about 30 carbon atoms, or $-(R^2O)_p R^{13}$; R^2 in each of the $(R^2O)_m$, $(R^2O)_n$, $(R^2O)_p$ and $(R^2O)_q$ groups is independently C_2 - C_4 alkylene; R^3 , R^8 , R^{11} ,

64725-903 (D)

10ss

R^{13} and R^{15} are independently hydrogen, or a hydrocarbyl or substituted hydrocarbyl having from 1 to about 30 carbon atoms; R^4 is $-(CH_2)_yOR^{13}$ or $-(CH_2)_yO(R^2O)_qR^3$; R^5 , R^6 and R^7 are independently hydrogen, hydrocarbyl or substituted hydrocarbyl having from 1 to about 30 carbon atoms, or R^4 ; R^{10} is hydrocarbylene or substituted hydrocarbylene having from 2 to about 30 carbon atoms; R^{14} is hydrocarbyl or substituted hydrocarbyl having from 1 to about 30 carbon atoms, or $-(CH_2)_zO(R^2O)_pR^3$; m , n , p and q are independently an average number from 1 to about 50; X is $-O-$, $-N(R^{14})-$, $-C(O)-$, $-C(O)O-$, $-OC(O)-$, $-N(R^{15})C(O)-$, $-C(O)N(R^{15})-$, $-S-$, $-SO-$, or $-SO_2-$; t is 0 or 1; A^- is an agriculturally acceptable anion; and y and z are independently an integer from 0 to about 30.

According to another aspect of the invention of the present divisional application, there is provided a composition for use in an aqueous pesticidal formulation containing a mixture of two or more of the surfactant compounds described herein.

According to another aspect of the invention of the parent application, there is provided a formulation useful in retarding the growth of vegetation comprising an aqueous mixture containing a surfactant, glyphosate or a salt or ester thereof, and a dicarboxylic acid, the nature of said surfactant and the composition of said formulation being such that, upon application of the formulation to a plant, anisotropic aggregates comprising said surfactant are formed on the foliage of said plant, and wherein the growth of the plant is controlled to a greater extent than in a plant treated with a reference application mixture devoid of the dicarboxylic acid but otherwise having the same composition as said formulation.

64725-903(D)

10tt

According to another aspect of the invention of the parent application, there is provided a formulation useful in retarding the growth of vegetation comprising an aqueous mixture containing a surfactant, glyphosate or a salt or ester thereof, and a dicarboxylic acid, said surfactant and said dicarboxylic acid being present in a weight ratio of between about 1:1 and about 50:1, the nature of said surfactant and the composition of said formulation being such that, upon application of the formulation to a plant, anisotropic aggregates comprising said surfactant are formed on the foliage of said plant.

According to still another aspect of the invention of the parent application, there is provided an aqueous herbicidal concentrate composition comprising (a) glyphosate, predominantly in the form of the potassium salt thereof; (b) a second water-soluble herbicide; and (c) a surfactant component in solution or stable suspension, emulsion or dispersion, comprising one or more surfactants; wherein the composition has a cloud point of at least about 50°C and a crystallization point not higher than about 0°C.

BRIEF DESCRIPTION OF THE DRAWINGS

Figures A1 and A2 show a birefringent pattern (A1 at 100 x magnification polarized light; A2 at 200 x magnification polarized light) of negative fan units, which are typical of hexagonal phase liquid crystals. The formulation which produced these epicuticular liquid crystals was comprised of potassium glyphosate and a mixture of surfactants. Specifically, the formulation comprised a 3:1 weight ratio of glyphosate to surfactant with potassium glyphosate and a mixture of Tomah 1816 E20PA and Witcamine 405 surfactants.

64725-903(D)

10uu

Figures B1 and B2 show a birefringent pattern (B1 at 100 x magnification polarized light; B2 at 200 x magnification polarized light) of fine mosaic patterns, which are typical of lamellar phase liquid crystals. The formulation which produced these epicuticular liquid crystals was comprised of isopropylamine glyphosate and a surfactant. Specifically, the formulation comprise a 3:1 weight

ratio of glyphosate to surfactant with isopropylamine glyphosate and Plurafac A38 surfactant.

DETAILED DESCRIPTION OF THE INVENTION

The pesticidal compositions of the invention include aqueous herbicidal compositions of the potassium salt of glyphosate or another glyphosate salt other than IPA glyphosate and a herbicidal efficacy enhancing amount of one or more surfactants. The compositions of the present invention are storage stable over a wide range of temperatures. Compositions of the present invention also exhibit enhanced viscosity characteristics and significantly lighter color as compared to glyphosate potassium salt compositions containing an alkylpolyglycoside surfactant in combination with an alkoxyated alkylamine surfactant. Such "enhanced viscosity" and "enhanced color" formulations are made possible by the selection of a surfactant system that does not include an alkylpolyglycoside surfactant, yet such formulations are still fully loaded so that, upon dilution in water, no additional surfactant is necessary prior to foliar application to attain commercial level performance. It has also been found that alkylpolyglycoside surfactants in combination with surfactants other than alkoxy alkylamine surfactants can be utilized to provide useful glyphosate potassium salt compositions, although without some of the enhanced viscosity characteristics of the more preferred compositions of the present invention that do not contain alkylpolyglycoside surfactants. Further, by controlling the amount of the alkylpolyglycoside present in the glyphosate potassium salt composition, a sufficient amount of alkoxyated alkylamine, or other surfactant described herein, can be utilized to prepare a suitable formulation. Generally, the ratio of alkylpolyglycoside to other surfactant should be between about 1:5 and 5:1, preferably between about 1:5 and 1:1.1, more preferably between about 1:5 and 1:1.2, and most preferably between about 1:5 and 1:1.5. The color of such concentrates is considerably lighter than the concentrates containing greater amounts of alkylpolyglycosides, and is less than 14, preferably less than about 13, 12, 11, 10, 9, 8, 7, 6 or 5.

The herbicidal formulations of the present invention may optionally contain one or more additional surfactants, one or more additional herbicides, and/or other adjuvants or ingredients such as, for example a di-carboxylic acid such as oxalic acid, or a salt or ester thereof. Formulations of the present invention may be prepared on site by the ultimate consumer shortly before application to the

64725-903 (D)

12

foliage of vegetation or weeds to be eliminated or controlled by diluting the aqueous concentrate herbicidal formulations, or by dissolving or dispersing solid particles containing glyphosate. Alternatively, herbicidal formulations of the present invention may be supplied to the ultimate consumer on a "ready to use" basis.

The present invention takes advantage of the high specific gravity of concentrated aqueous solutions of glyphosate potassium salt. Accordingly, at a given percent concentration by weight, an aqueous concentrate composition of glyphosate potassium salt delivers to the user a significantly higher weight of active ingredient per unit volume of the composition than a corresponding composition of glyphosate IPA salt.

In one embodiment of the invention, it has been found that in an aqueous concentrate formulation, an unexpectedly high weight/volume concentration of glyphosate potassium salt can be obtained in the presence of an agriculturally useful surfactant content, with the resulting composition exhibiting acceptable, or in some instance improved, viscosity and storage stability characteristics. The choice of surfactant has been found to be extremely important to achieving these results.

In such embodiment, therefore, the present invention provides an aqueous herbicidal composition comprising:

- (1) N-phosphonomethylglycine, predominantly in the form of the potassium salt thereof, in solution in the water in an amount in excess of about 360 grams N-phosphonomethylglycine acid equivalent per liter of the composition; and
- (2) a surfactant component in solution or stable dispersion in the water, comprising one or more surfactants present in an agriculturally useful amount. It is preferred that the surfactant component is selected such that the composition has a viscosity of not greater than about 1000 centipoise at 10°C, a cloud point not lower than about 50°C, and preferably exhibits substantially no crystallization of glyphosate or salt thereof when stored at a temperature of about 0°C for a period of up to about 7 days. More preferably, the composition has a viscosity of not greater than about 500 centipoise at 45 reciprocal seconds at 10°C, with not greater than 250, 225, 200, 175, 150, 125 or 100 centipoise being most preferred. However, higher viscosities may be acceptable in certain

circumstance, such as, for example, where low temperature pumping considerations are not important. The surfactant component, as added to the aqueous herbicidal concentrate composition, is in solution or is a stable suspension, emulsion, or dispersion.

The word "predominantly" in the above context means that at least about 50%, preferably at least about 75% and more preferably at least about 90%, by weight of the glyphosate, expressed as a.e., is present as the potassium salt. The balance can be made up of other salts and/or glyphosate acid but it is preferred that the viscosity, cloud point, and non-crystallization properties of the composition remain within the limits indicated.

As a further aspect of the present invention, a particular class of surfactants has been identified wherein compatibility with glyphosate potassium salt concentrations of greater than 300 g a.e./l to about 600 g a.e./l is unexpectedly high. Accordingly, an embodiment of the invention is a surfactant-containing herbicidal composition as described above wherein the surfactant component predominantly comprises one or more surfactants each having a molecular structure comprising:

- (1) a hydrophobic moiety comprising at least one hydrocarbyl or substituted hydrocarbyl group; and
- (2) a hydrophilic moiety comprising (i) an amino, ammonium or amine oxide group comprising hydrocarbyl or substituted hydrocarbyl substituents; and/or (ii) a carbohydrate group.

The carbohydrate of the hydrophilic moiety is preferably a sugar such as a monosaccharide, disaccharide or polysaccharide. Preferred sugars include glycosides such as alkyl glycosides, alkyl polyglycosides and aminoglycosides. Surfactants containing on average no more than about two carbohydrate groups per surfactant molecule are preferred.

In such surfactants, the hydrophobic moiety is attached to the hydrophilic moiety in one of the following ways. The terminal atom of the hydrophobic moiety is attached (a) directly to the nitrogen within an amino, ammonium or amine oxide group if present, or (b) directly to the carbohydrate group if present.

In a preferred embodiment, the hydrophobic moiety of the surfactant is a substituted hydrocarbyl group comprising at least one oxyalkylene group in the principle chain. Such substituted hydrocarbyl groups include, for example, alkyloxyalkylene and alkenyloxyalkylene groups containing from one to thirty

64725-903 (D)

14

oxyalkylene groups RO in which R in each of the RO groups is independently C₂-C₄ alkylene.

In one embodiment of the invention, the surfactant component predominantly comprises one or more surfactants each having a molecular structure comprising:

- (1) a hydrophobic moiety having one or a plurality of independently saturated or unsaturated, branched or unbranched, aliphatic, alicyclic or aromatic C₃₋₁₈ hydrocarbyl or hydrocarbylidene groups joined together by 0 to about 7 linkages independently selected from ether, thioether, sulfoxide, ester, thioester and amide linkages, this hydrophobic moiety having in total a number *J* of carbon atoms where *J* is about 8 to about 30; and
- (2) a hydrophilic moiety comprising:
 - (i) an amino group that is cationic or that can be protonated to become cationic, having attached directly thereto 0 to 3 oxyethylene groups or polyoxyethylene chains, these oxyethylene groups and polyoxyethylene chains comprising on average no more than a number *E* of oxyethylene units per surfactant molecule such that $E + J \leq 50$; and/or
 - (ii) an alkyl sugar derivative unit, such as a glycoside, polyglycoside, or aminoglycoide group comprising on average no more than about 2 of the alkyl sugar derivative units per surfactant molecule.

In such surfactants the hydrophobic moiety is attached to the hydrophilic moiety in one of the following ways: (a) directly to an amino group if present, (b) by an ether linkage incorporating an oxygen atom of one of the oxyethylene groups if present or of a terminal oxyethylene unit of one of the polyoxyethylene chains if present, or (c) by an ether linkage to one of the alkyl sugar derivative units if present.

In a preferred embodiment, *J* is about 8 to about 25, and $E + J$ is no more than 45, preferably no more than 40, and more preferably no more than 28. For example, compound JJJ in Table 4 includes a hydrophobic moiety having 24 total number of carbons and a hydrophilic moiety including 9 total oxyethylene units such that $E + J = 33$. Compound C includes 18 carbon atoms (*J*) in its hydrophobic moiety, and 7 total oxyethylene units (*E*) such that $E + J = 25$.

64725-903 (D)

15

In one embodiment of the invention, the surfactant component predominantly comprises one or more surfactants each having a molecular structure comprising:

- (1) a hydrophobic moiety having one or a plurality of independently saturated or unsaturated, branched or unbranched, aliphatic, alicyclic or aromatic C₃₋₁₈ hydrocarbyl or hydrocarbylidene groups joined together by 0 to about 7 linkages independently selected from ether, thioether, sulfoxide, ester, thioester and amide linkages, this hydrophobic moiety having in total a number *J* of carbon atoms where *J* is about 8 to about 18; and
- (2) a hydrophilic moiety comprising:
 - (i) an amino group that is cationic or that can be protonated to become cationic, having attached directly thereto 0 to 3 oxyethylene groups or polyoxyethylene chains, these oxyethylene groups and polyoxyethylene chains comprising on average no more than a number *E* of oxyethylene units per surfactant molecule such that $E + J \leq 22$; and/or
 - (ii) an alkyl sugar derivative unit, such as a glycoside, polyglycoside, or aminoglycoide group comprising on average no more than about 2 of the alkyl sugar derivative units per surfactant molecule.

In such surfactants the hydrophobic moiety is attached to the hydrophilic moiety in one of the following ways: (a) directly to an amino group if present, (b) by an ether linkage incorporating an oxygen atom of one of the oxyethylene groups if present or of a terminal oxyethylene unit of one of the polyoxyethylene chains if present, or (c) by an ether linkage to one of the alkyl sugar derivative units if present.

In the context of surfactant content, the expression "predominantly comprises" means that at least about 50%, preferably at least about 75% and more preferably at least about 90%, by weight of the surfactant component is made up of surfactants having the specified features of molecular structure. For the present purpose, the weight or concentration of surfactant component as defined herein does not include essentially non-surfactant compounds that are sometimes introduced with the surfactant component, such as water, isopropanol

64725-903 (D)

16

or other solvents, or glycols (such as ethylene glycol, propylene glycol, polyethylene glycol, etc.).

Without in any way limiting the scope of the present invention, various subclasses of surfactants, defined by formulas (5), and (6) below, are particularly useful in compositions of the invention.

One embodiment of the invention is a herbicidal concentrate composition as described above wherein the surfactant component predominantly comprises one or more chemically stable surfactants having formula (5):

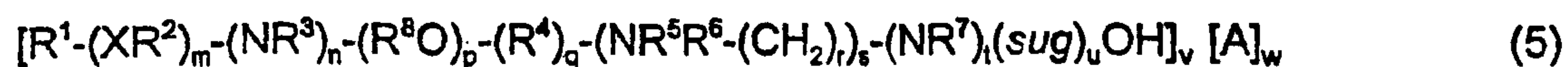

where R^1 is hydrogen or C_{1-18} hydrocarbyl, each X is independently an ether, thioether, sulfoxide, ester, thioester or amide linkage, each R^2 is independently C_{2-6} hydrocarbylidene, m is an average number of 0 to about 8, the total number of carbon atoms in $R^1-(XR^2)_m$ is about 8 to about 24, n is 0 or 1, p is an average number of 0 to about 5, R^3 , R^4 , R^5 , R^6 and R^7 are independently hydrogen or C_{1-4} hydrocarbyl, R^8 is independently C_2-C_4 alkylene, q is 0 or 1, r is 0 to 4, s is 0 or 1, t is 0 or 1, sug is (i) an open or cyclic structure derived from sugars, such as, for example, glucose or sucrose (referred to herein as a sugar unit), or (ii) a hydroxyalkyl, polyhydroxyalkyl or poly(hydroxyalkyl)alkyl group, u is an average number from 1 to about 2, A is an anionic entity, and v is an integer from 1 to 3 and w is 0 or 1 such that electrical neutrality is maintained. An example of a preferred compound of the type defined by formula 5 is a glucosamine where R^1 is C_8H_{17} hydrocarbyl, m , p , q , s , t , and w are 0, n , u and v are 1, R^3 is hydrogen, and sug is an open glucose derivative having the structure $CH(OH)CH(OH)CH(OH)CH(OH)CH_2$

Another embodiment of the invention is a herbicidal concentrate composition as described above wherein the surfactant component predominantly comprises one or more surfactants having formula (6):

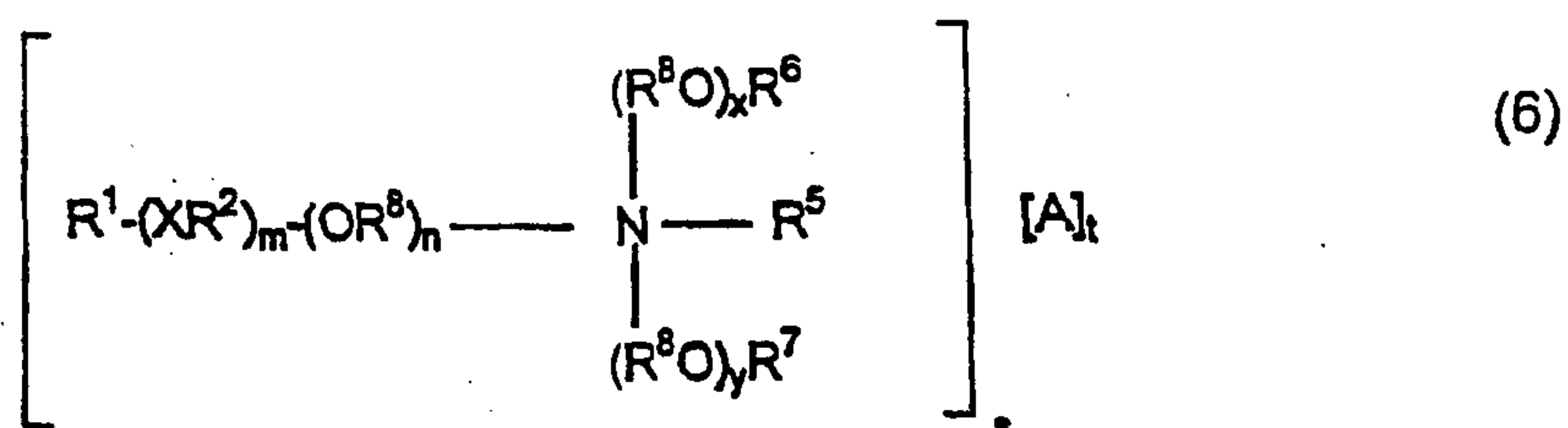

64725-903 (D)

17

where R^1 is hydrogen or C_{1-18} hydrocarbyl, each X is independently an ether, thioether, sulfoxide, ester, thioester or amide linkage, each R^2 is independently C_{2-6} hydrocarbylidene, each R^3 is independently C_2-C_4 alkylene; m is an average number of 0 to about 9, the total number J of carbon atoms in $R^1-(XR^2)_m$ is about 8 to about 18, n is an average number of 0 to about 5, R^5 is hydrogen, C_{1-4} alkyl, benzyl, an anionic oxide group or an anionic group $-(CH_2)_uC(O)O$ where u is 1 to 3, R^6 and R^7 are independently hydrogen, C_{1-4} alkyl or C_{2-4} acyl, x and y are average numbers such that $x + y + n$ is not greater than the number E as defined above, A is an anionic entity and s is an integer from 1 to 3 and t is 0 or 1 such that electrical neutrality is maintained.

It will be appreciated that surfactants conforming to formulas (5) or (6) above include non-restrictively those that can be described as alkyl polyglucosides, alkylaminoglucosides, polyoxyalkylene alkylamines, polyoxyalkylene alkyletheramines, alkyltrimethylammonium salts, alkyldimethylbenzylammonium salts, polyoxyalkylene N -methyl alkylammonium salts, polyoxyalkylene N -methyl alkyletherammonium salts, alkyldimethylamine oxides, polyoxyalkylene alkylamine oxides, polyoxyalkylene alkyletheramine oxides, alkylbetaines, alkylamidopropylamines and the like. In one embodiment of the invention, the average number of oxyalkylene units, such as oxyethylene units, if present, per surfactant molecule is no greater than $22-J$ where J is as defined above, and the average number of glucose units, if present, per surfactant molecule is no greater than about 2. In another embodiment of the invention, the average number of oxyalkylene units, such as oxyethylene units, if present, per surfactant molecule is no greater than $50-J$ where J is as defined above, and the average number of glucose units, if present, per surfactant molecule is no greater than about 42.

Illustrative surfactant types that have been found useful in compositions of the invention include the following:

- (A) Surfactants corresponding to formula (5) where R^1 is a C_{8-18} aliphatic, saturated or unsaturated, linear or branched hydrocarbyl chain, m , n , p , s , t and w are 0, and v is 1. This group includes several commercial surfactants collectively known in the art or referred to herein as "alkyl polyglucosides" or "APGs". Suitable examples are sold by Henkel as Agrimul™ PG-2069 and Agrimul™ PG-2076.

64725-903 (D)

18

(B) Surfactants corresponding to formula (6) where R^1 is a C_{6-18} aliphatic, saturated or unsaturated, linear or branched hydrocarbyl chain and m is 0. In this group R^1 alone forms the hydrophobic moiety of the surfactant and is attached directly to the amino function, as in alkylamines, or by an ether linkage formed by the oxygen atom of an oxyalkylene group or the terminal oxygen atom of a polyoxyalkylene chain, as in certain alkyletheramines.

Illustrative subtypes having different hydrophilic moieties include:

- (1) Surfactants wherein x and y are 0, R^5 and R^6 are independently C_{1-4} alkyl, R^7 is hydrogen and t is 1. This subtype includes (where R^5 and R^6 are each methyl) several commercial surfactants known in the art or referred to herein as "alkyldimethylamines". Suitable examples are dodecyldimethylamine, available for example from Akzo as Armeen™ DM12D, and cocodimethylamine and tallowdimethylamine, available for example from Ceca as Noram™ DMC D and Noram™ DMS D respectively. Such surfactants are generally provided in non-protonated form, the anion A not being supplied with the surfactant. However, in a glyphosate potassium salt formulation at a pH of about 4-5, the surfactant will be protonated and it will be recognized that the anion A can be glyphosate, which is capable of forming dibasic salts.
- (2) Surfactants wherein x and y are 0, R^5 , R^6 and R^7 are independently C_{1-4} alkyl and t is 1. This subtype includes (where R^5 , R^6 and R^7 are each methyl and A is a chloride ion) several commercial surfactants known in the art or referred to herein as "alkyltrimethylammonium chlorides". A suitable example is cocoalkyl trimethylammonium chloride, available for example from Akzo as Arquad™ C.
- (3) Surfactants wherein $x + y$ is 2 or greater, R^6 and R^7 are hydrogen and t is 1. This subtype includes commercial surfactants known in the art or referred to herein as "polyoxyalkylene alkylamines" (where n is 0 and R^5 is hydrogen), certain "polyoxyalkylene alkyletheramines" (where n is 1-5 and R^5 is hydrogen), "polyoxyalkylene

64725-903 (D)

19

–methyl alkylammonium chlorides" (where n is 0 and R⁵ is methyl), and certain "polyoxyalkylene –methyl alkyletherammonium chlorides" (where n is 1-5 and R is methyl). Suitable examples are polyoxyethylene (2) cocoamine, polyoxyethylene (5) tallowamine and polyoxyethylene (10) cocoamine, available for example from Akzo as Ethomeen™ C/12, Ethomeen™ T/15 and Ethomeen™ C/20 respectively; a surfactant conforming, when its amine group is non-protonated, to formula (7):

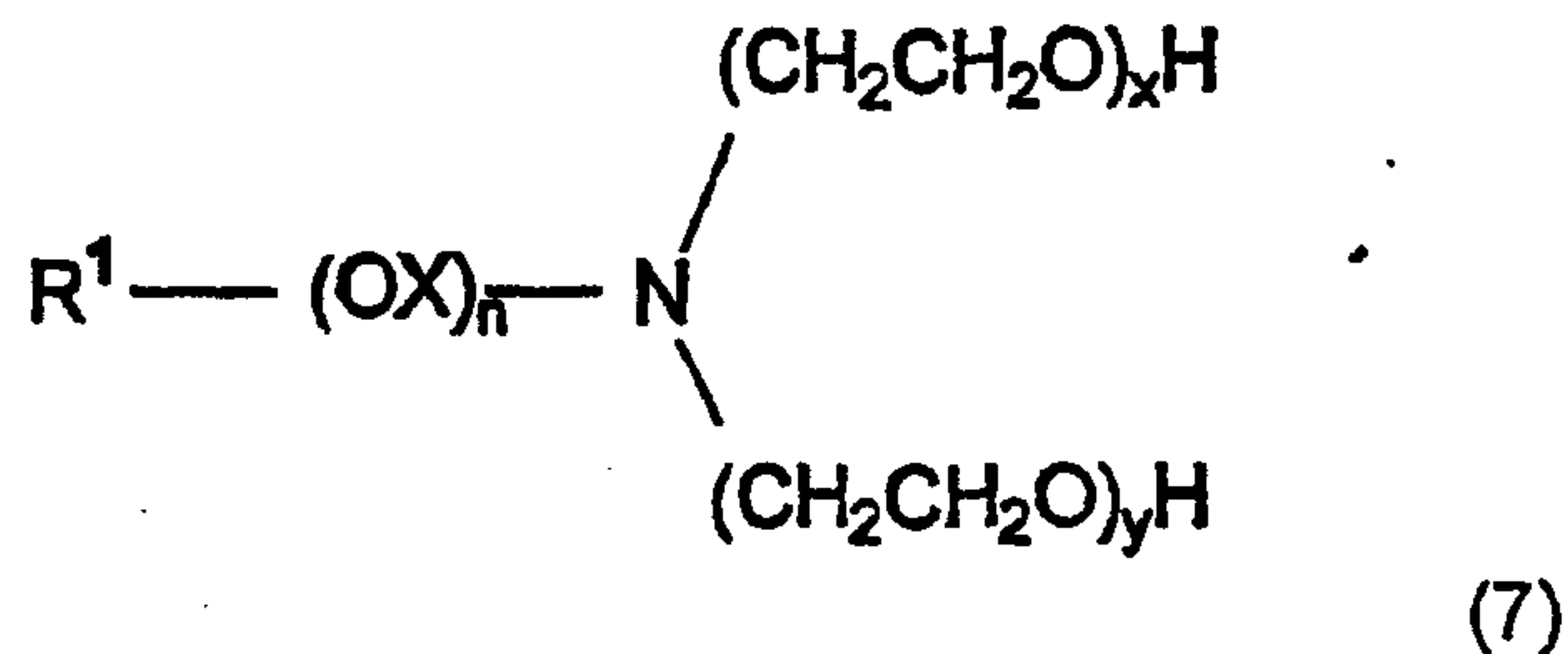

where R¹ is C₁₂₋₁₅ alkyl, X is ethyl, propyl or methyl ethyl, and x + y is 5, as disclosed in U.S. Patent No. 5,750,468; and polyoxyethylene (2) N-methyl cocoammonium chloride and polyoxyethylene (2) N-methyl stearylammmonium chloride, available for example from Akzo as Ethoquad™ C/12 and Ethoquad™ 18/12 respectively. In cases where R⁵ is hydrogen, *i.e.*, in tertiary as opposed to quaternary ammonium surfactants, the anion A is typically not supplied with the surfactant. However, in a glyphosate potassium salt formulation at a pH of about 4-5, it will be recognized that the anion A can be glyphosate, which is capable of forming dibasic salts.

- (4) Surfactants wherein R⁵ is an anionic oxide group and t is 0. This subtype includes commercial surfactants known in the art or referred to herein as "alkyldimethylamine oxides" (where n, x and y are 0, and R⁶ and R⁷ are methyl), certain "alkyletherdimethylamine oxides" (where n is 1-5, x and y

64725-903 (D)

20

are 0, and R^6 and R^7 are methyl), "polyoxyalkylene alkylamine oxides" (where n is 0, $x + y$ is 2 or greater, and R^6 and R^7 are hydrogen), and certain "polyoxyalkylene alkyletheramine oxides" (where n is 1-5, $x + y$ is 2 or greater, and R^6 and R^7 are hydrogen). Suitable examples are cocodimethylamine oxide, sold by Akzo as Aromox™ DMC, and polyoxyethylene (2) cocoamine oxide, sold by Akzo as Aromox™ C/12.

- (5) Surfactants wherein R^5 is an anionic group $-\text{CH}_2\text{C}(\text{O})\text{O}$ (acetate), x and y are 0 and t is 0. This subtype includes commercial surfactants known in the art or referred to herein as "alkylbetaines" (where n is 0, R^5 is acetate and R^6 and R^7 are methyl) and certain "alkyletherbetaines" (where n is 1-5, R^5 is acetate and R^6 and R^7 are methyl). A suitable example is cocobetaine, sold for example by Henkel as Velvetex™ AB-45.

- (C) Surfactants corresponding to formula (6) where R^1 is a C_{8-18} aliphatic, saturated or unsaturated, linear or branched hydrocarbonyl chain, m is 1, X is an ether linkage, R^2 is n -propylene and n is 0. In this group R^1 together with OR^2 forms the hydrophobic moiety of the surfactant which is attached directly by the R^2 linkage to the amino function. These surfactants are a subclass of alkyletheramines as disclosed in U.S. Patent No. 5,750,468. Illustrative subtypes have the different hydrophilic moieties exemplified in (B-1) to (B-5) above. Suitable examples are a surfactant conforming, when its amine group is non-protonated, to formula (8):

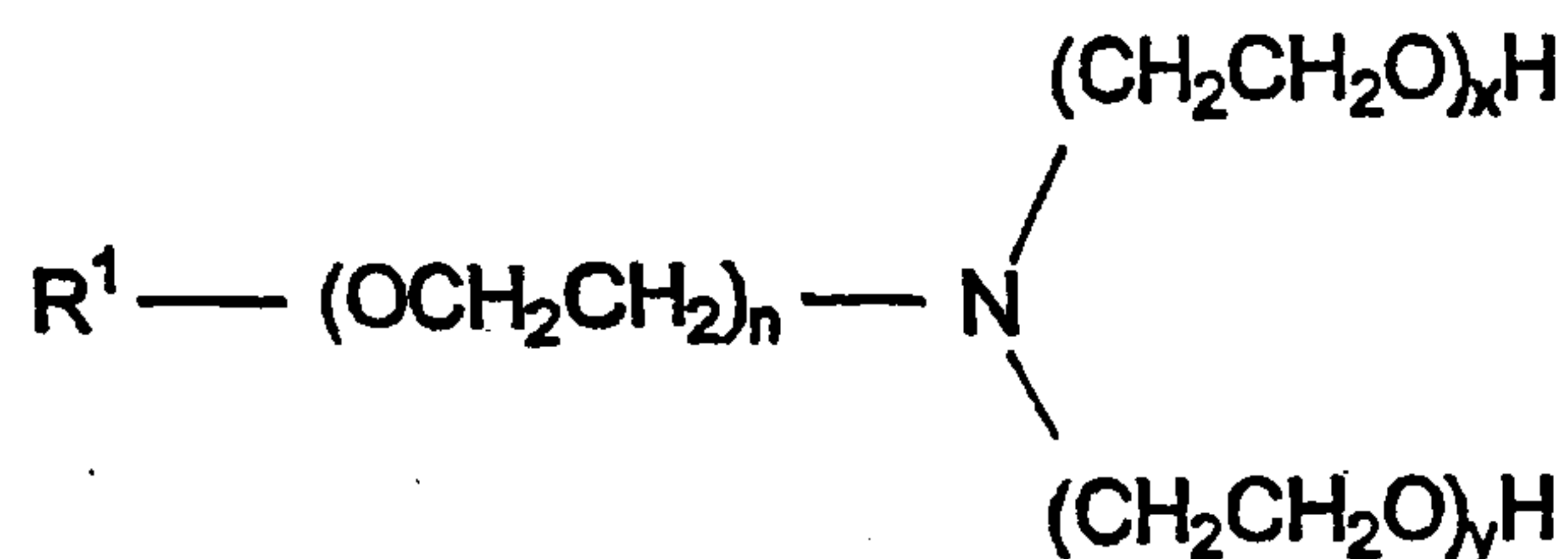

(8).

64725-903 (D)

21

a surfactant conforming to formula (9):

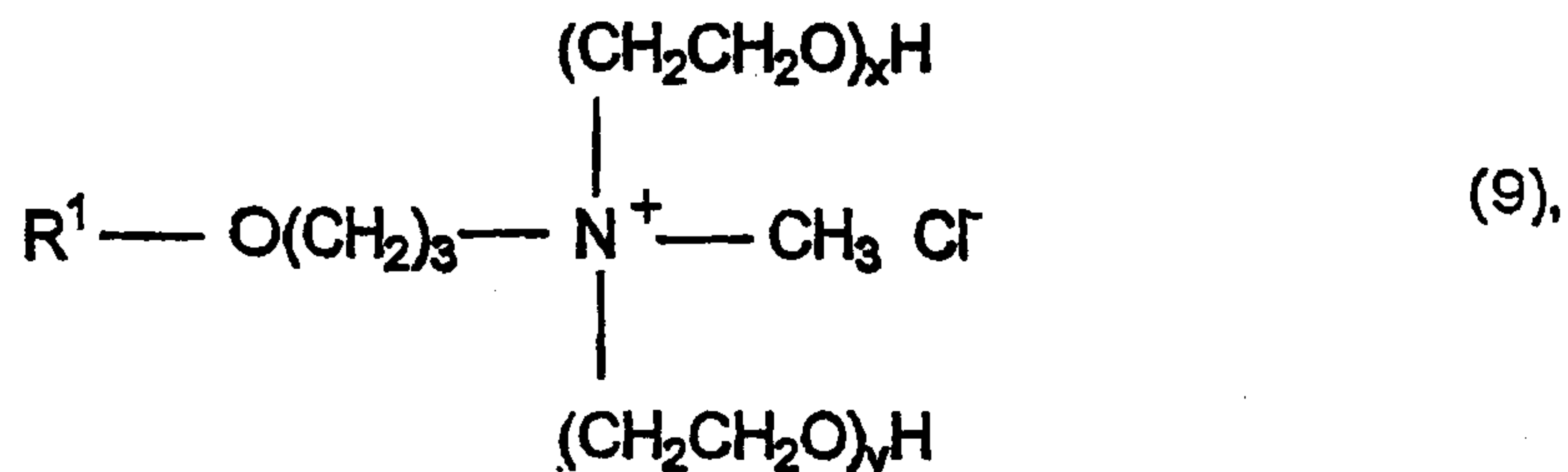

and a surfactant conforming to formula (10):

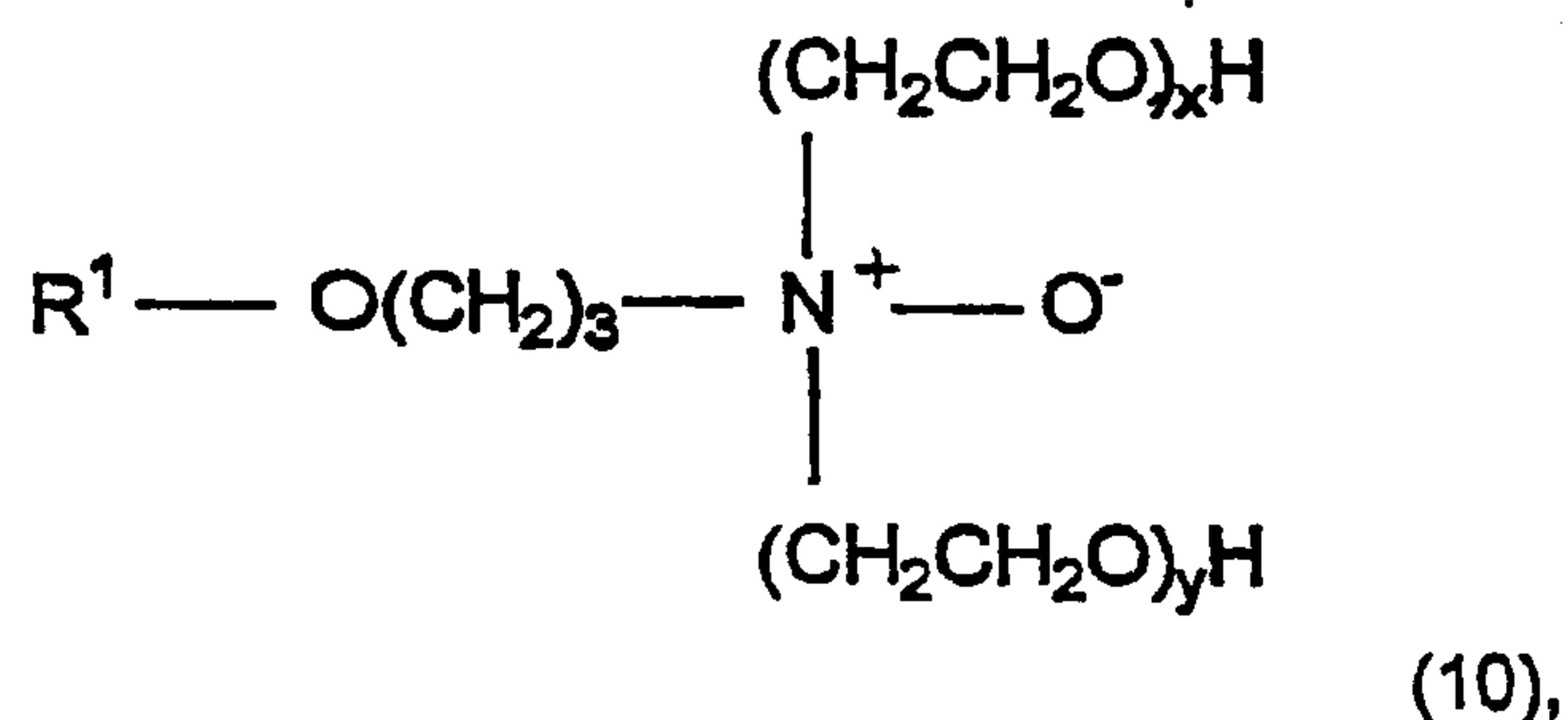

where, in each of formulas (8), (9) and (10), R¹ is C₁₂₋₁₅ alkyl and x + y is 5, as disclosed in U.S. Patent No. 5,750,468.

- (D) Surfactants corresponding to formula (6) where R¹ is a C₈₋₁₈ aliphatic, saturated or unsaturated, linear or branched hydrocarbyl chain, m is 1-5, each XR² is a group -OCH(CH₃)CH₂- and n is 0. In this group R¹ together with the -OCH(CH₃)CH₂- groups forms the hydrophobic moiety of the surfactant which is

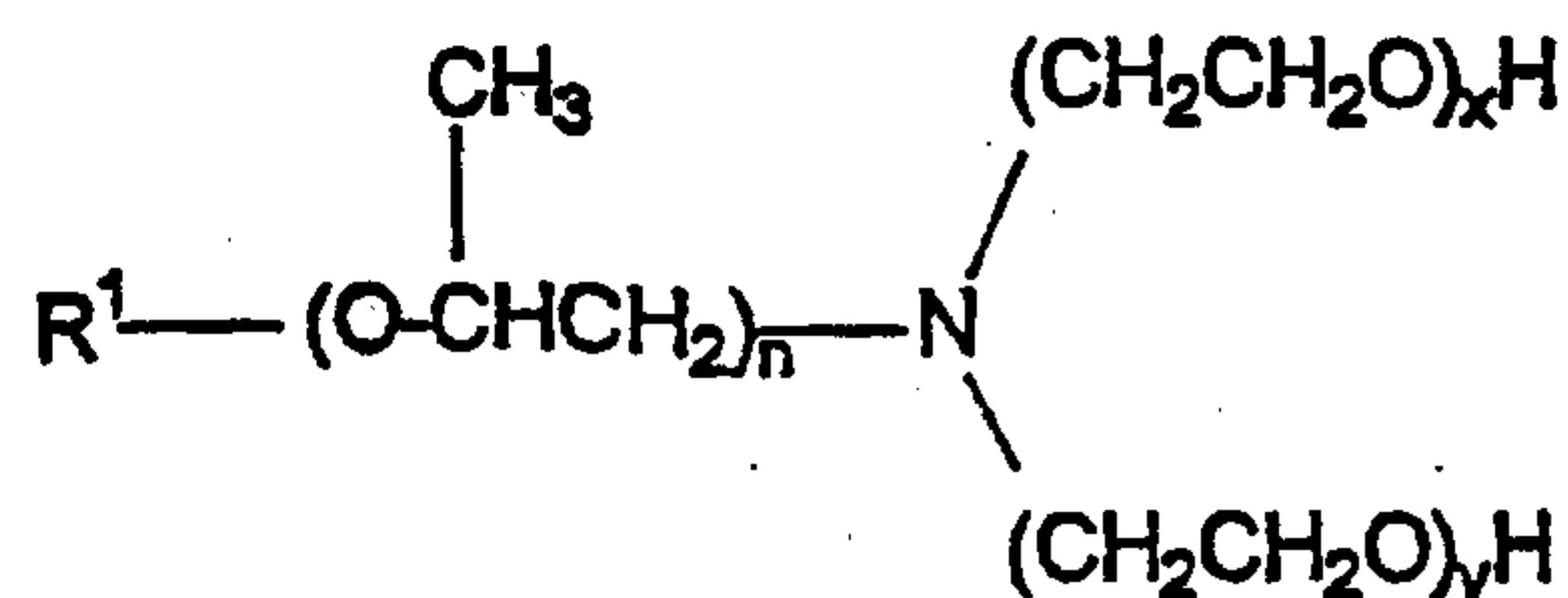

attached directly to the amino function. These surfactants are a further subclass of alkyletheramines as disclosed in U.S. Patent

No. 5,750,468. Illustrative subtypes have the different hydrophilic moieties exemplified in (B-1) to (B-5) above.

- (E) Surfactants corresponding to formula (6) where R^1 is a C_{8-18} aliphatic, saturated or unsaturated, linear or branched hydrocarbyl chain, m is 1, X is an amide linkage, R^2 is n -propylene and n is 0. In this group R^1 together with XR^2 forms the hydrophobic moiety of the surfactant which is attached directly by the R^2 linkage to the amino function. In preferred surfactants of this group, x and y are 0, R^5 is hydrogen or C_{1-4} alkyl, R^6 and R^7 are independently C_{1-4} alkyl and t is 1. A suitable example is cocoamidopropyl dimethylamine propionate, sold for example by McIntyre as Mackalene™ 117.
- (F) Surfactants corresponding to formula (6) where R^1 is hydrogen, m is 3-8 and each XR^2 is a group $-OCH(CH_3)CH_2-$. In this group the polyether chain of $-OCH(CH_3)CH_2-$ groups (a polyoxypropylene chain) forms the hydrophobic moiety of the surfactant which is linked directly or via one or more oxyethylene units to the amino function. In preferred surfactants of this group, x and y are 0, R^5 , R^6 and R^7 are independently C_{1-4} alkyl and t is 1. These surfactants are a subclass of the polyoxypropylene quaternary ammonium surfactants disclosed in U.S. Patent No. 5,652,197. In a suitable example, m is 7, n is 1, R^5 , R^6 and R^7 are each methyl, and A is chloride.

In surfactants where t is 1, A can be any agriculturally acceptable anion but preferably is chloride, bromide, iodide, sulfate, ethosulfate, phosphate, acetate, propionate, succinate, lactate, citrate or tartrate, or, as indicated above, glyphosate.

In one embodiment of the invention the composition contains a surfactant of a class of alkyletheramines disclosed in U.S. Patent No. 5,750,468. In a further embodiment, surfactants present are other than alkyletheramines as disclosed in U.S. Patent No. 5,750,468.

In another embodiment of the invention the composition contains a surfactant having the general formula (11):



64725-903 (D)

23

where R¹ and R² are independently a C₄₋₁₈ aliphatic, saturated or unsaturated, linear or branched hydrocarbyl chain, R³ and R⁴ are independently a C₁₋₄ alkyl or hydrogen, and n is greater than 2. A particularly preferred compound of this description is where R¹ and R² are C₈H₁₇, n is 3, and R³ and R⁴ are hydrogen.

In yet another embodiment of the invention the composition contains a surfactant having the general formula (12):



where R¹ is C₈₋₁₈ aliphatic, saturated or unsaturated, linear or branched hydrocarbyl, R² and R³ are independently C₁₋₁₀, preferably C₁₋₄ alkyl or hydrogen, and n is 1 or greater, preferably 2 to 15. It is believed that at least one compound within this formula has not heretofore been reported in the prior art, and is therefore, a novel compound per se. The structure for this compound is



This novel compound, as well as its use as a pesticidal adjuvant, and in particular with glyphosate, and even more particularly with glyphosate potassium salt, is all within the scope of this invention. Additionally, the hydroxy analogs of the foregoing compound show particularly good compatibility with glyphosate potassium salt formulations.

In other embodiments of the invention, the composition contains a surfactant having one or more of the following the formulas:



where R¹ is C₈₋₁₈ aliphatic, saturated or unsaturated, linear or branched hydrocarbyl chain, R², R³, R⁴, and R⁵ are independently a C₁₋₄ alkyl or hydrogen, X is an anionic entity, and n is 2 or greater;



where R¹ is a C₄₋₁₈ aliphatic, saturated or unsaturated, linear or branched hydrocarbyl chain, R² and R³ are independently a C₁₋₄ alkyl or hydrogen, and n is equal to 2 or greater;

64725-903 (D)

24

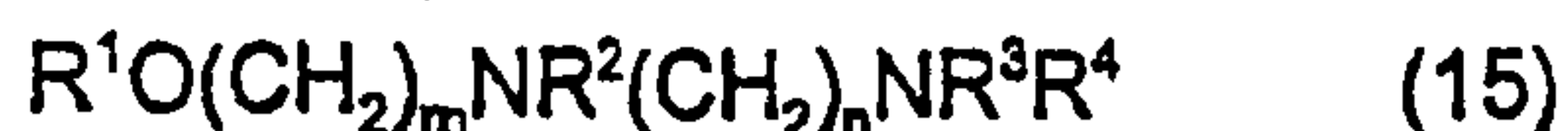

where R^1 is a C_{4-18} aliphatic, saturated or unsaturated, linear or branched hydrocarbyl chain, R^2 , R^3 and R^4 are independently a C_{1-4} alkyl or hydrogen, and m and n are independently equal to 2 or greater;

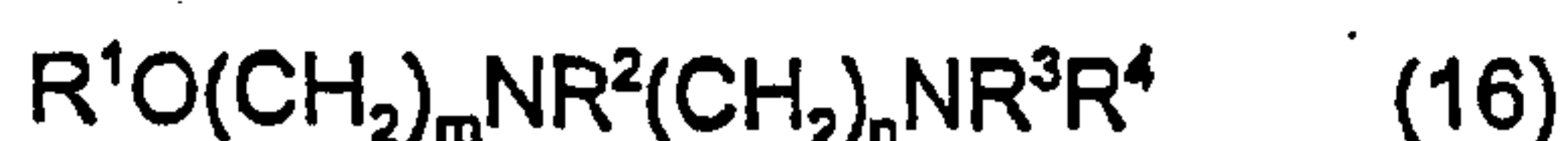

where R^1 is a C_{4-18} aliphatic, saturated or unsaturated, linear or branched hydrocarbyl chain, R^2 , R^3 and R^4 are independently a poly(oxyethylene) chains having a combined total of equal to or greater than 3 moles of ethylene oxide, and m and n are independently equal to 2 or greater;



where R^1 is a C_{4-18} aliphatic, saturated or unsaturated, linear or branched hydrocarbyl chain, R^2 and R^3 are independently methyl or hydrogen, m and p are independently equal or greater than about 2 and equal to or less than about 6, n and q are independently equal to about 1-10;



where R^1 is a C_{4-18} aliphatic, saturated or unsaturated, linear or branched hydrocarbyl chain, R^2 and R^3 are independently a C_{1-4} alkyl or hydrogen, X is an amide linkage, and n is equal to 2 or greater;



where R^1 is a C_{4-18} aliphatic, saturated or unsaturated, linear or branched hydrocarbyl chain, and R^2 and R^3 are independently a C_{1-4} alkyl;



where R^1 is a C_{4-18} aliphatic, saturated or unsaturated, linear or branched hydrocarbyl chain, and R^2 is a C_{1-4} alkyl or hydrogen and "carbohydrate" is a carbohydrate for example, $-CH_2CH(OH)CH(OH)CH(OH)CH(OH)CH_2OH$. Further,

64725-903 (D)

25

other derivatives, such as, for example, ethoxylated or nonethoxylated alkyl or amide derivatives of amino sugars (particularly 2-aminoglucose) are of particular interest in glyphosate or other herbicide/pesticide formulations. Di-sugar amines are also of particular interest in this regard.



where R^1 is a C_{4-18} aliphatic, saturated or unsaturated, linear or branched hydrocarbyl chain, and R^2 and R^3 are independently a C_{1-4} alkyl or hydrogen and n is 2 or greater, preferably n is 2 or 3;



where R^1 , R^2 , R^3 and R^4 are independently a C_{1-4} alkyl, polyoxyethylene or hydrogen and m and p are independently 2 or greater, preferably 2 or 3, and n is 1 or greater, preferably 1.

Novel surfactants have been discovered which are particularly suitable for use in formulating pesticide compositions, such as herbicides. The surfactants have been found to be highly compatible with various water soluble salts of glyphosate, especially potassium, ammonium, and diammonium glyphosate. Cationic surfactants suitable in formulating pesticide formulations include:

(a) monoalkoxylated amines having the formula:

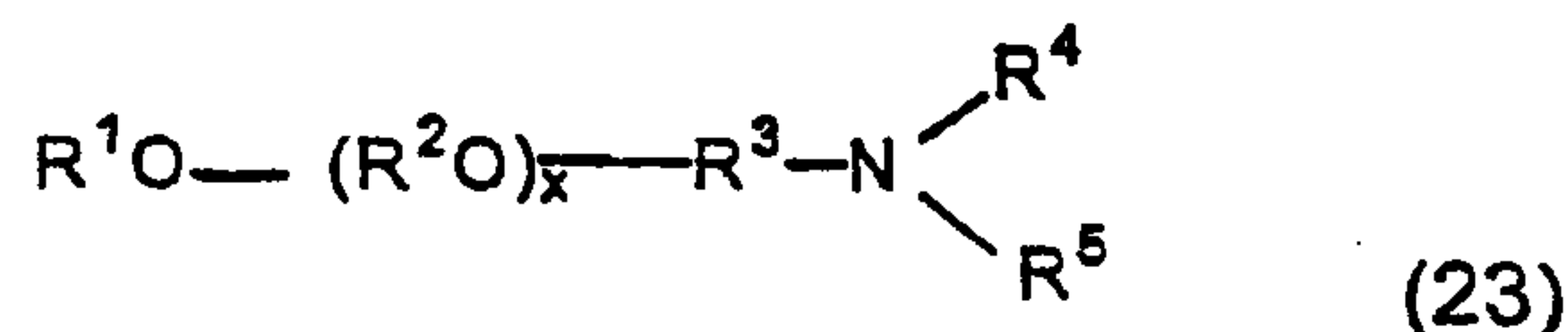

wherein R^1 is hydrogen or hydrocarbyl or substituted hydrocarbyl having at least 7 carbon atoms (preferably containing 8 to about 30 carbon atoms); R^2 in each of the x (R^2O) and y (R^2O) groups is independently C_2-C_4 alkylene; R^3 is a hydrocarbylene or substituted hydrocarbylene having from 2 to about 6 carbon atoms; R^4 and R^5 are each independently hydrogen, hydrocarbyl or substituted hydrocarbyl having from 1 to about 30 carbon atoms, $-(R^6)_n-(R^2O)_yR^7$, or R^4 and R^5 , together with the nitrogen atom to which they are attached, form a cyclic or heterocyclic ring; R^6 is hydrocarbylene or substituted hydrocarbylene containing from 1 to about 6 carbon atoms, R^7 is hydrogen or a linear or branched alkyl group having 1 to about 4 carbon atoms, n is 0 or 1, and x and y are independently an average number from 1 to about 60, provided, however, that

64725-903 (D)

26

when R^2 and R^3 in each of the x (R^2O) groups is ethylene, R^1 is other than unsubstituted alkyl or R^4 is other than hydrogen or unsubstituted alkyl when R^5 is hydrogen or unsubstituted alkyl, and when R^2 and R^3 are isopropylene and x is 1, R^1 is other than unsubstituted alkyl or R^4 is other than $-(R^2O)_yR^7$. In this context, preferred R^1 , R^4 , R^5 and R^6 hydrocarbyl (hydrocarbylene) groups include linear or branched alkyl (alkylene), linear or branched alkenyl (alkenylene), linear or branched alkynyl (alkynylene), aryl (arylene), or aralkyl (aralkylene) groups. Preferably, R^1 is a linear or branched alkyl or linear or branched alkenyl group having from about 8 to about 25 carbon atoms, R^2 in each of the x (R^2O) groups is independently C_2 - C_4 alkylene, R^3 is an ethylene or 2-hydroxypropylene group, R^4 and R^5 are each independently hydrogen or a linear or branched alkyl group having from 1 to about 6 carbon atoms, and x is an average number from 1 to about 30. More preferably, R^1 is a linear or branched alkyl group having from about 12 to about 22 carbon atoms, R^2 in each of the x (R^2O) groups is independently ethylene or propylene, R^3 is an ethylene or 2-hydroxypropylene group, R^4 and R^5 are each independently hydrogen, methyl, or tris(hydroxymethyl)methyl, and x is an average number from about 2 to about 30. Even more preferably, R^1 is a linear or branched alkyl group having from about 12 to about 18 carbon atoms, R^2 in each of the x (R^2O) groups is independently ethylene or propylene, R^3 is an ethylene or 2-hydroxypropylene group, R^4 and R^5 are each independently hydrogen or methyl, and x is an average number from about 4 to about 20. Most preferably, R^1 is a linear or branched alkyl group having from about 12 to about 18 carbon atoms, R^2 in each of the x (R^2O) groups is independently ethylene or propylene, R^3 is an ethylene or 2-hydroxypropylene group, R^4 and R^5 are methyl, and x is an average number from about 4 to about 20.

(b) alkoxyated poly(hydroxyalkyl)amines having the formula:

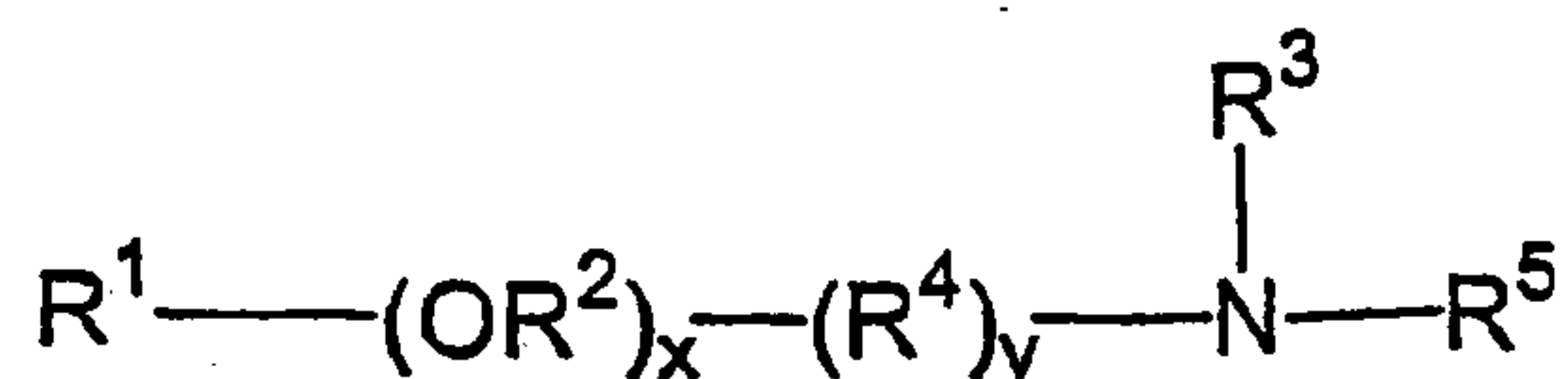

(24)

wherein R^1 and R^3 are independently hydrogen, hydrocarbyl or substituted hydrocarbyl having from 1 to about 30 carbon atoms, R^2 in each of the x (R^2O) groups is independently C_2 - C_4 alkylene; R^4 is hydrocarbylene or substituted hydrocarbylene having from 1 to about 30 carbon atoms, R^5 is hydroxyalkyl,

64725-903 (D)

27

polyhydroxyalkyl, or poly(hydroxyalkyl)alkyl; x is an average number from 0 to about 30, and y is 0 or 1. In this context, preferred R¹, R³, and R⁴ hydrocarbyl (hydrocarbylene) groups are linear or branched alkyl (alkylene), linear or branched alkenyl (alkenylene), linear or branched alkynyl (alkynylene), aryl (arylene), or aralkyl (aralkylene) group. Preferred alkoxyated poly(hydroxyalkyl)amines have the formula:

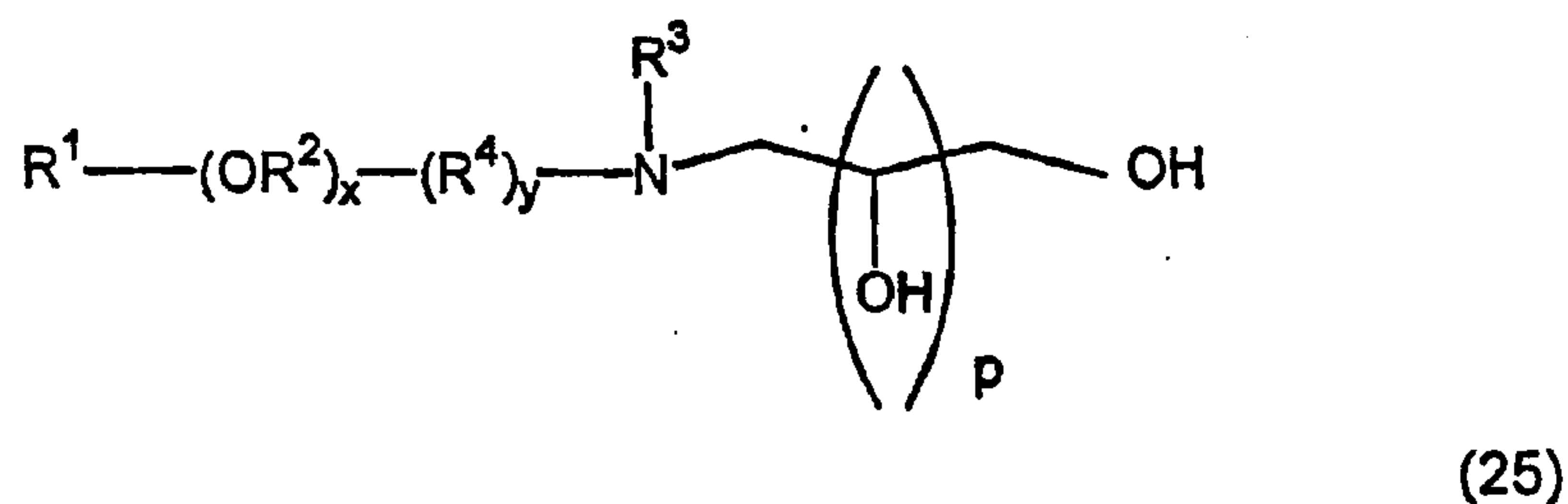

or

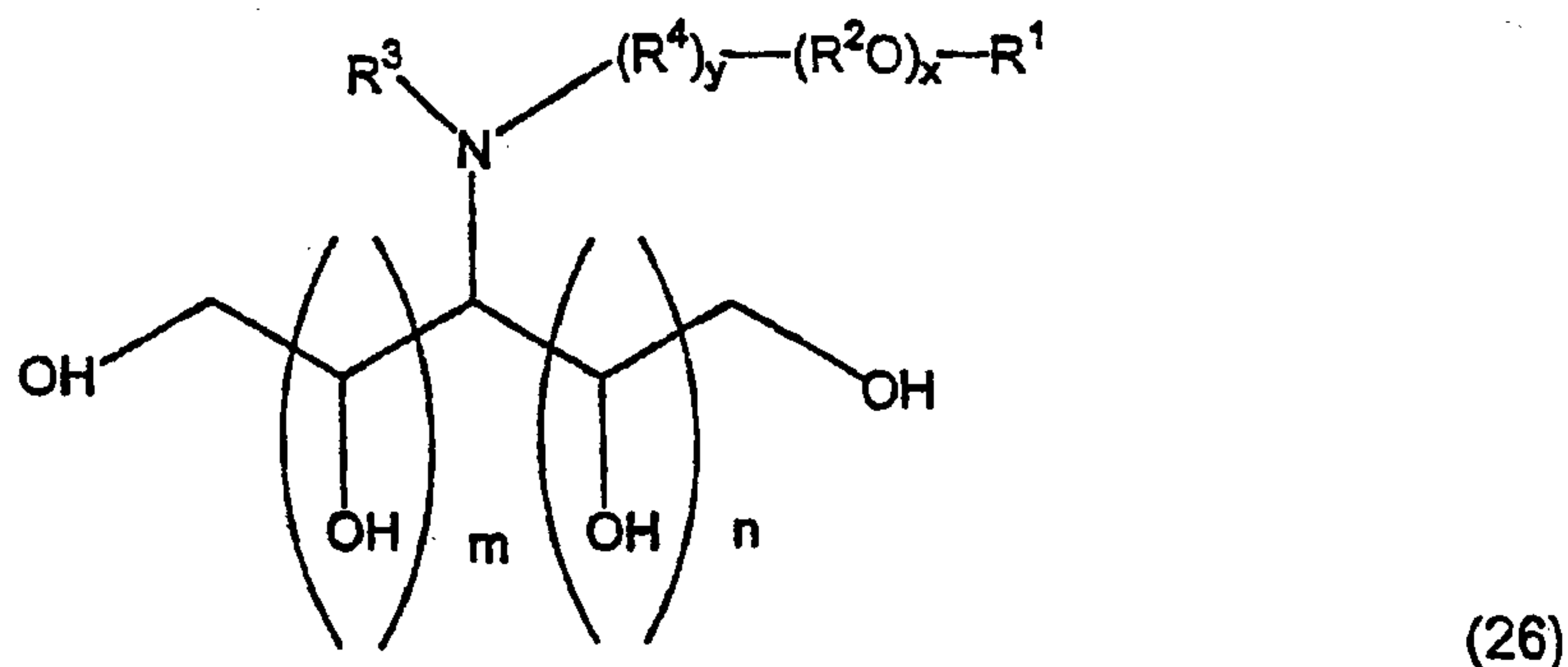

wherein R¹ and R³ are independently hydrogen, hydrocarbyl or substituted hydrocarbyl having from 1 to about 30 carbon atoms, R² in each of the x (R²O) groups is independently C₂-C₄ alkylene; R⁴ is hydrocarbylene or substituted hydrocarbylene having from 1 to about 30 carbon atoms, m and n are independently integers from 0 to about 7, the sum of m and n is not greater than about 7, p is an integer from 1 to about 8, x is an average number from 0 to about 30, and y is 0 or 1. In this context, preferred R¹, R³, and R⁴ hydrocarbyl (hydrocarbylene) groups are linear or branched alkyl (alkylene), linear or branched alkenyl (alkenylene), linear or branched alkynyl (alkynylene), aryl (arylene), or aralkyl (aralkylene) group. Preferably, R¹ is a linear or branched alkyl or linear or branched alkenyl group having from about 8 to about 30 carbon atoms; R² in each of the x (R²O) groups is independently C₂-C₄ alkylene; R³ is hydrogen, a linear or branched alkyl or linear or branched alkenyl group having from 1 to about 30 carbon atoms; R⁴ is a linear or branched alkylene having from

64725-903 (D)

28

1 to about 30 carbon atoms, m and n are independently integers from 0 to about 7, the sum of m and n is from about 3 to 7, p is an integer from 1 to about 8, x is an average number from 0 to about 30, and y is 0 or 1. More preferably, R¹ is a linear or branched alkyl group having from about 8 to about 22 carbon atoms; R² in each of the x (R²O) groups is independently ethylene or propylene; R³ is hydrogen, or a linear or branched alkyl group having from 1 to about 6 carbon atoms; R⁴ is a linear or branched alkylene having from 1 to about 6 carbon atoms, m and n are independently integers from 0 to about 7, the sum of m and n is from about 3 to 7, p is an integer from 1 to about 8, x is an average number from 0 to about 30, and y is 0 or 1. Most preferably, R¹ is a linear or branched alkyl group having from about 8 to about 18 carbon atoms; R² in each of the x (R²O) groups is independently ethylene or propylene; R³ is hydrogen or methyl; m and n are independently integers from 0 to about 7, the sum of m and n is from about 3 to 7, p is an integer from 1 to about 8, x is an average number from 0 to about 30, and y is 0.

(c) di-poly(hydroxyalkyl)amines having the formula:

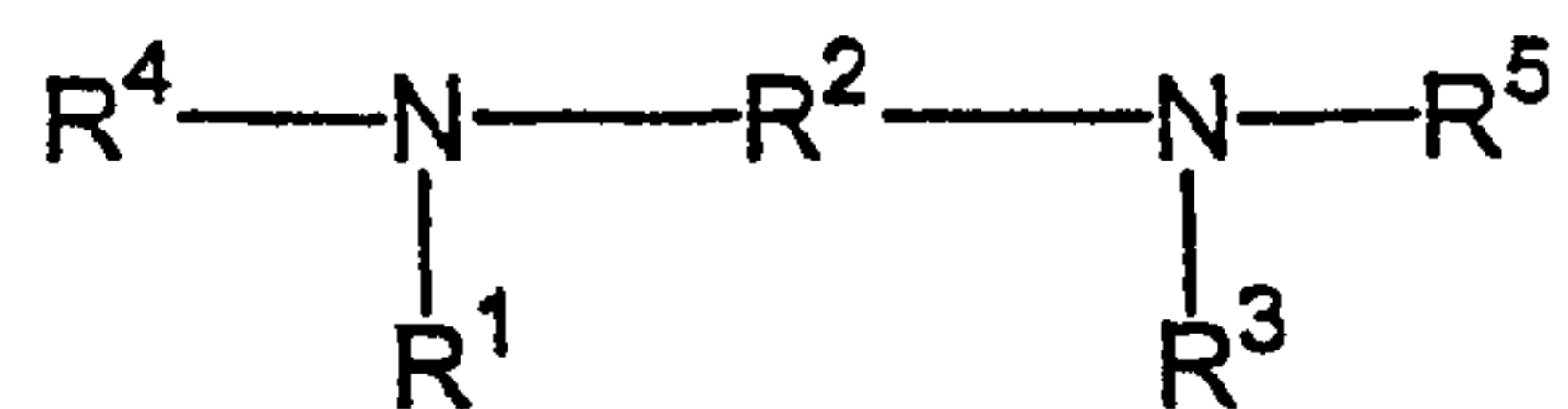

(27)

wherein R¹ and R³ are independently hydrogen or hydrocarbyl or substituted hydrocarbyl having from 1 to about 22 carbon atoms, R² is hydrocarbylene or substituted hydrocarbylene having from 2 to about 18 carbon atoms, R⁴ and R⁵ are independently hydroxyalkyl, polyhydroxyalkyl, or poly(hydroxyalkyl)alkyl, provided, however, that when R¹ and R³ are methyl, R² is other than octylene. In this context, preferred R¹, R² and R³ hydrocarbyl (hydrocarbylene) groups are linear or branched alkyl (alkylene), linear or branched alkenyl (alkenylene), linear or branched alkynyl (alkynylene), aryl (arylene), or aralkyl (aralkylene) groups. Preferred di-poly(hydroxyalkyl)amines have the formula:

64725-903 (D)

29

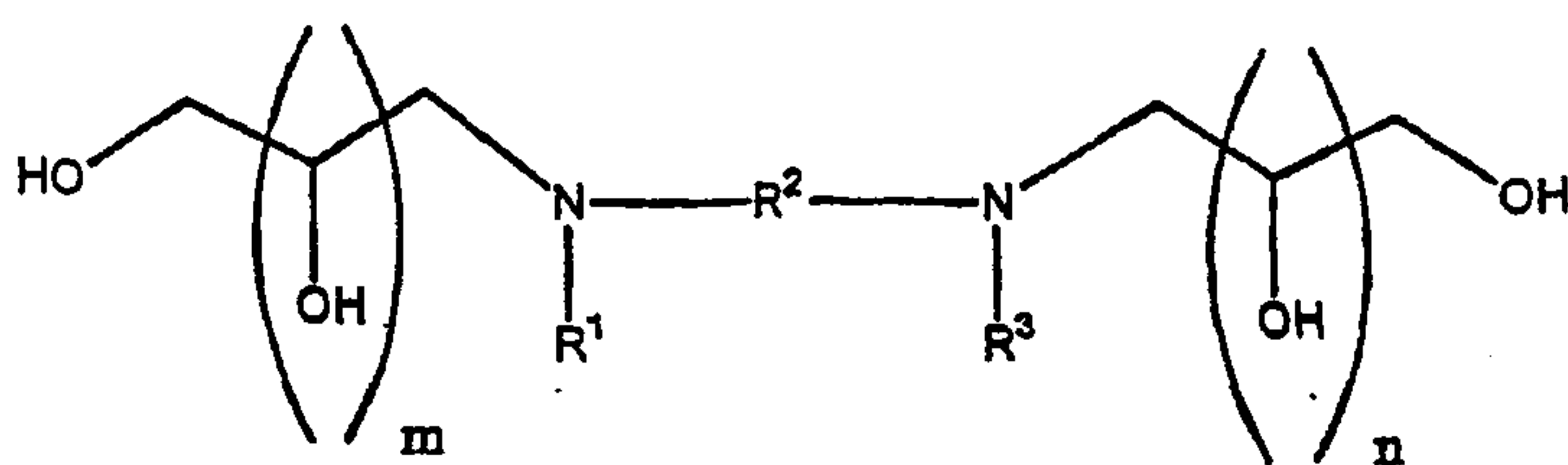

(28)

wherein R^1 and R^3 are independently hydrogen or hydrocarbyl or substituted hydrocarbyl having from 1 to about 22 carbon atoms, R^2 is hydrocarbylene or substituted hydrocarbylene having from 2 to about 18 carbon atoms, and m and n are independently integers from 1 to about 8, provided, however, that when R^1 and R^3 are methyl, R^2 is other than octylene. In this context, preferred R^1 , R^2 and R^3 hydrocarbyl (hydrocarbylene) groups are linear or branched alkyl (alkylene), linear or branched alkenyl (alkenylene), linear or branched alkynyl (alkynylene), aryl (arylene), or aralkyl (aralkylene) groups. In one embodiment, R^1 and R^3 are independently hydrogen or a linear or branched alkyl group having from 1 to about 6 carbon atoms, R^2 is a linear or branched alkylene, linear or branched alkenylene, linear or branched alkynylene, arylene, and alkylarylene group having from 9 to about 18 carbon atoms, and m and n are as defined above. In another embodiment, R^1 and R^3 are independently hydrogen or a linear or branched alkyl group having from 2 to about 22 carbon atoms, R^2 is a linear or branched alkylene, linear or branched alkenylene, linear or branched alkynylene, arylene, and alkylarylene group having from 2 to 7 carbon atoms, and m and n are as defined above. Preferably, R^1 and R^3 are independently hydrogen or a linear or branched alkyl group having from 1 to about 18 carbon atoms, R^2 is a linear or branched alkylene or linear or branched alkenylene group having from 2 to about 18 carbon atoms, and m and n are independently integers from 1 to about 8. More preferably, R^1 and R^3 are independently hydrogen or a linear or branched alkyl group having from 6 to about 12 carbon atoms, R^2 is a linear or branched alkylene group having from 2 to about 6 carbon atoms, and m and n are independently integers from about 4 to about 8; or R^1 and R^3 are independently hydrogen or a linear or branched alkyl group having from 1 to about 4 carbon atoms, R^2 is a linear or branched alkylene group having from 2 to about 16 carbon atoms, and m and n are independently integers from about 4 to about 8. Most

64725-903 (D)

30

preferably, R^1 and R^3 are independently hydrogen or a linear or branched alkyl group having from 6 to about 12 carbon atoms, R^2 is ethylene or propylene, and m and n are independently integers from about 4 to about 8; or R^1 and R^3 are independently hydrogen or a linear or branched alkyl group having from 1 to about 4 carbon atoms, R^2 is a linear or branched alkylene group having from 2 to about 12 carbon atoms, and m and n are independently integers from about 4 to about 8.

(d) alkoxyated triamines having the formula:

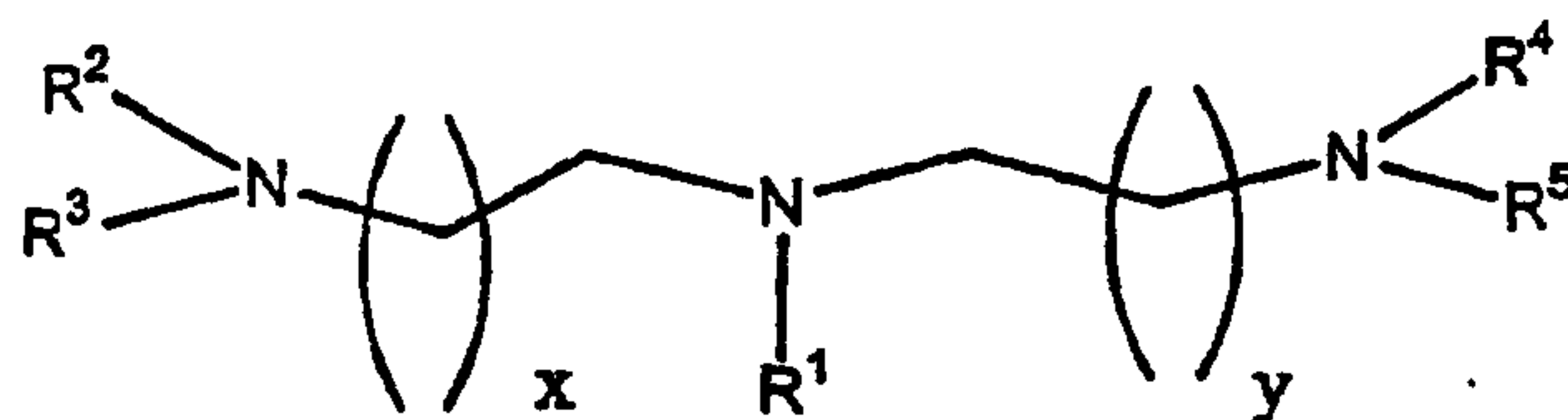

wherein R^1 is hydrocarbyl or substituted hydrocarbyl having from 1 to about 30 carbon atoms; R^2 , R^3 , R^4 and R^5 are independently hydrogen, hydrocarbyl or substituted hydrocarbyl having from 1 to about 30 carbon atoms, or $-(R^6)_s$, $(R^7-O)_nR^6$; R^6 is hydrogen, or a linear or branched alkyl group having from 1 to about 4 carbon atoms; R^7 in each of the n (R^7O) groups is independently C_2-C_4 alkylene; R^8 is hydrocarbylene or substituted hydrocarbylene having from 1 to about 6 carbon atoms; n is an average number from 1 to about 10; s is 0 or 1; and x and y are independently an integer from 1 to about 4; provided, however, that when R^1 is alkyl, R^2 is other than hydrogen, x is 3 or 4, or R^4 is other than $-(R^6)_s$. In this context, preferred R^1 , R^2 , R^3 , R^4 , R^5 and R^8 hydrocarbyl (hydrocarbylene) groups are linear or branched alkyl (alkylene), linear or branched alkenyl (alkenylene), linear or branched alkynyl (alkynylene), aryl (arylene), or aralkyl (aralkylene) groups. In one embodiment, R^2 is a linear or branched alkyl, linear or branched alkenyl, linear or branched alkynyl, aryl, or aralkyl group having from 1 to about 30 carbon atoms, or $-(R^6)_s$, $(R^7-O)_nR^6$, and the remaining groups are as described above. Preferably, R^1 is a linear or branched alkyl or linear or branched alkenyl groups having from about 8 to about 30 carbon atoms, R^2 , R^3 , R^4 and R^5 are independently hydrogen, a linear or branched alkyl or linear or branched alkenyl group having from 1 to about 30 carbon atoms, or $-(R^6)_nR^6$, R^6 is hydrogen, methyl or ethyl; R^7 in each of the n (R^7O) groups is

64725-903 (D)

31

independently C₂-C₄ alkylene, n is an average number from 1 to about 10, and x and y are independently an integer from 1 to about 4. More preferably, R¹ is a linear or branched alkyl group having from about 8 to about 18 carbon atoms, R², R³, R⁴ and R⁵ are independently hydrogen, a linear or branched alkyl group having from 1 to about 6 carbon atoms, or -(R⁷-O)_nR⁶, R⁶ is hydrogen or methyl, R⁷ in each of the n (R⁷O) groups is independently ethylene or propylene, n is an average number from 1 to about 5, and x and y are independently an integer from 1 to about 4. Most preferably, R¹ is a linear or branched alkyl group having from about 8 to about 18 carbon atoms, R², R³, R⁴ and R⁵ are independently hydrogen, or -(R⁷-O)_nR⁶, R⁶ is hydrogen, R⁷ in each of the n (R⁷O) groups is independently ethylene or propylene, n is an average number from 1 to about 5, and x and y are independently an integer from 1 to about 4.

(e) monoalkoxylated amines having the formula:

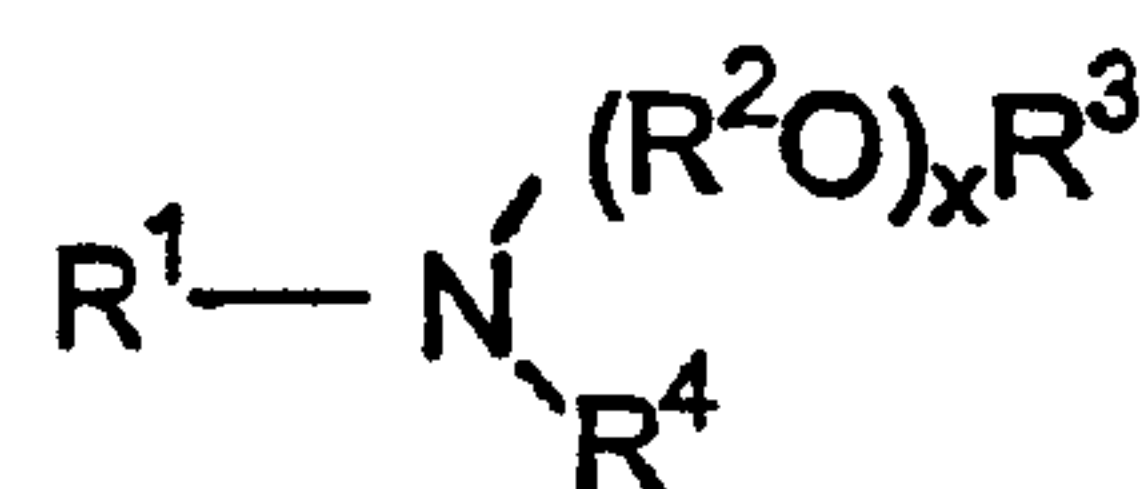

(30)

wherein R¹ is a hydrocarbyl or substituted hydrocarbyl group having from 1 to about 30 carbon atoms, R² is C₂-C₄ alkylene, R³ is hydrogen, or a linear or branched alkyl group having from 1 to about 4 carbon atoms, R⁴ is a linear or branched alkynyl, aryl, or aralkyl group having from 1 to about 30 carbon atoms, and x is an average number from 1 to about 60. In this context, preferred R¹ hydrocarbyl or substituted hydrocarbyl groups are linear or branched alkyl, linear or branched alkenyl, linear or branched alkynyl, aryl, or aralkyl groups.

Preferably, R¹ is a linear or branched alkyl or linear or branched alkenyl group having from 1 to about 25 carbon atoms, R² is C₂-C₄ alkylene, R³ is hydrogen, methyl or ethyl, R⁴ is a linear or branched alkynyl, aryl, or aralkyl group having from 1 to about 25 carbon atoms, and x is an average number from 1 to about 40. More preferably, R¹ is a linear or branched alkyl group having from 8 to about 22 carbon atoms, R² is ethylene or propylene, R³ is hydrogen or methyl, R⁴ is a linear or branched alkynyl, aryl, or aralkyl group having from 1 to about 6 carbon atoms, and x is an average number from 1 to about 20. In one embodiment, the compound has the formula shown in Table 4.C.

64725-903 (D)

32

(f) amine oxides having the formula:

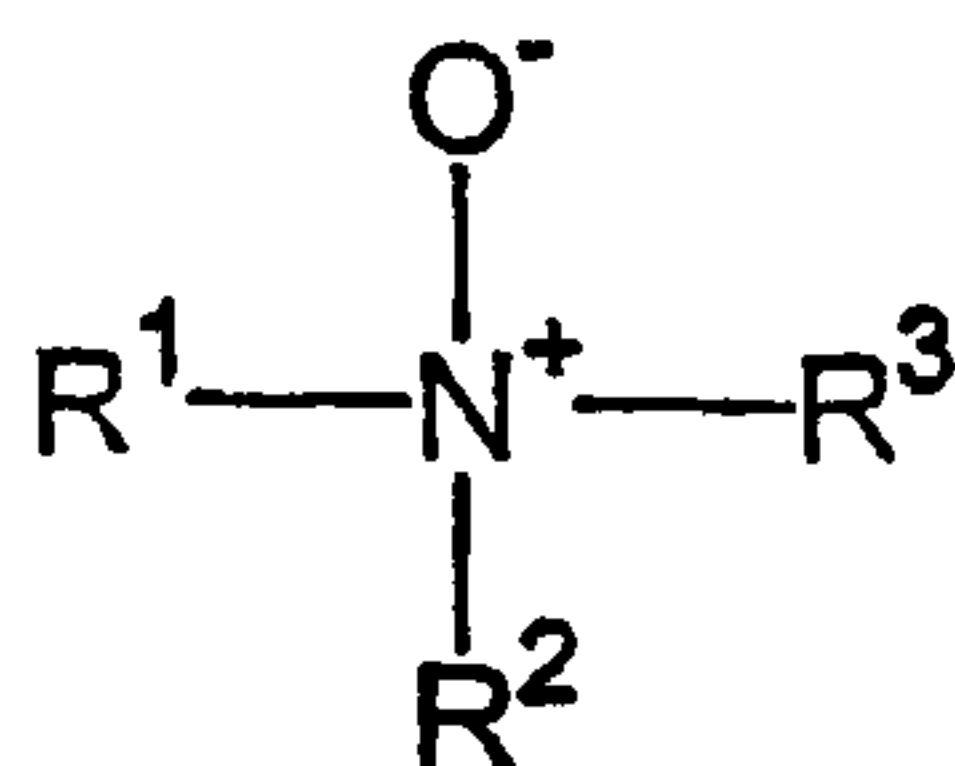

(31)

wherein R¹ is hydrocarbyl or substituted hydrocarbyl having from about 8 to about 30 carbon atoms, R² and R³ are independently -(R⁴O)_xR⁵, R⁴ in each of the x (R⁴O) groups is independently C₂-C₄ alkylene, R⁵ is hydrogen, or a hydrocarbyl or substituted hydrocarbyl having from 1 to about 30 carbon atoms, x is an average number from 1 to about 50. In this context, preferred R¹ and R⁵ hydrocarbyl groups are linear or branched alkyl, linear or branched alkenyl, linear or branched alkynyl, aryl, or aralkyl groups. Preferably, R¹ is a linear or branched alkyl or linear or branched alkenyl group having from about 8 to about 22 carbon atoms, R² and R³ are independently -(R⁴O)_xR⁵, R⁴ in each of the x (R⁴-O) groups is independently C₂-C₄ alkylene; R⁵ is hydrogen or a linear or branched alkyl or linear or branched alkenyl group having from about 1 to about 30 carbon atoms; and x is an average number from 1 to about 20. More preferably, R¹ is a linear or branched alkyl group having from about 8 to about 22 carbon atoms, R² and R³ are independently -(R⁴O)_xR⁵, R⁴ in each of the x (R⁴-O) groups is independently ethylene or propylene; R⁵ is hydrogen or a linear or branched alkyl or linear or branched alkenyl group having from about 1 to about 30 carbon atoms; and x is an average number from 1 to about 10. Most preferably, R¹ is a linear or branched alkyl group having from about 8 to about 18 carbon atoms, R² and R³ are independently -(R⁴O)_xR⁵, R⁴ in each of the x (R⁴-O) groups is independently ethylene or propylene; R⁵ is hydrogen or an alkyl group having from about 8 to about 18 carbon atoms; and x is an average number from 1 to about 5.

(g) an alkoxyated amine oxide having the formula:

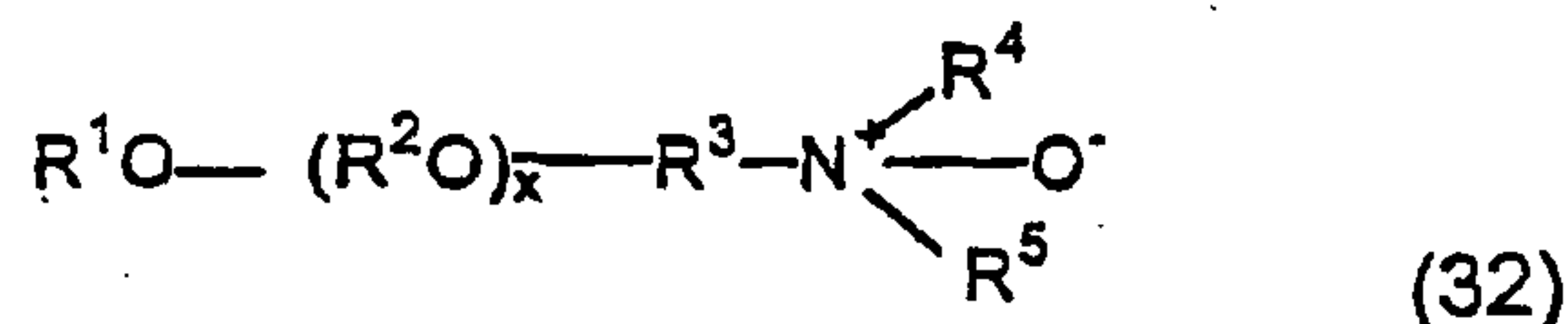

wherein R¹ is hydrogen or hydrocarbyl or substituted hydrocarbyl having from 1 to about 30 carbon atoms; R² in each of the x (R²O) and y (R²O) groups is independently C₂-C₄ alkylene; R³ is a hydrocarbylene or substituted

64725-903 (D)

33

hydrocarbylene having from 2 to about 6 carbon atoms; R^4 and R^5 are each independently hydrogen, hydrocarbyl or substituted hydrocarbyl having from 1 to about 30 carbon atoms, $-(R^6)_n-(R^2O)_yR^7$; R^6 is hydrocarbylene or substituted hydrocarbylene containing from 1 to about 6 carbon atoms, R^7 is hydrogen or a linear or branched alkyl group having 1 to about 4 carbon atoms, n is 0 or 1, and x and y are independently an average number from 1 to about 60. In this context, preferred R^1 , R^4 , R^5 and R^6 hydrocarbyl (hydrocarbylene) groups include linear or branched alkyl (alkylene), linear or branched alkenyl (alkenylene), linear or branched alkynyl (alkynylene), aryl (arylene), or aralkyl (aralkylene) groups. Preferably, R^1 is a linear or branched alkyl or linear or branched alkenyl group having from about 8 to about 25 carbon atoms, R^2 in each of the x (R^2O) groups is independently C_2 - C_4 alkylene, R^3 is a linear or branched alkylene or alkenylene group having from 2 to about 6 carbon atoms, R^4 and R^5 are each independently hydrogen or a linear or branched alkyl group having from 1 to about 6 carbon atoms, and x is an average number from 1 to about 30. More preferably, R^1 is a linear or branched alkyl group having from about 12 to about 22 carbon atoms, R^2 in each of the x (R^2O) groups is independently ethylene or propylene, R^3 is a linear or branched alkylene or alkenylene group having from 2 to about 6 carbon atoms, R^4 and R^5 are each independently hydrogen, methyl, or tris(hydroxymethyl)methyl, and x is an average number from about 2 to about 30. Even more preferably, R^1 is a linear or branched alkyl group having from about 12 to about 18 carbon atoms, R^2 in each of the x (R^2O) groups is independently ethylene or propylene, R^3 is an ethylene, propylene or 2-hydroxypropylene group, R^4 and R^5 are each independently hydrogen or methyl, and x is an average number from about 4 to about 20. Most preferably, R^1 is a linear or branched alkyl group having from about 12 to about 18 carbon atoms, R^2 in each of the x (R^2O) groups is independently ethylene or propylene, R^3 is an ethylene, propylene, or 2-hydroxypropylene group, R^4 and R^5 are methyl, and x is an average number from about 4 to about 20.

(h) alkoxyated diamines having the formula:

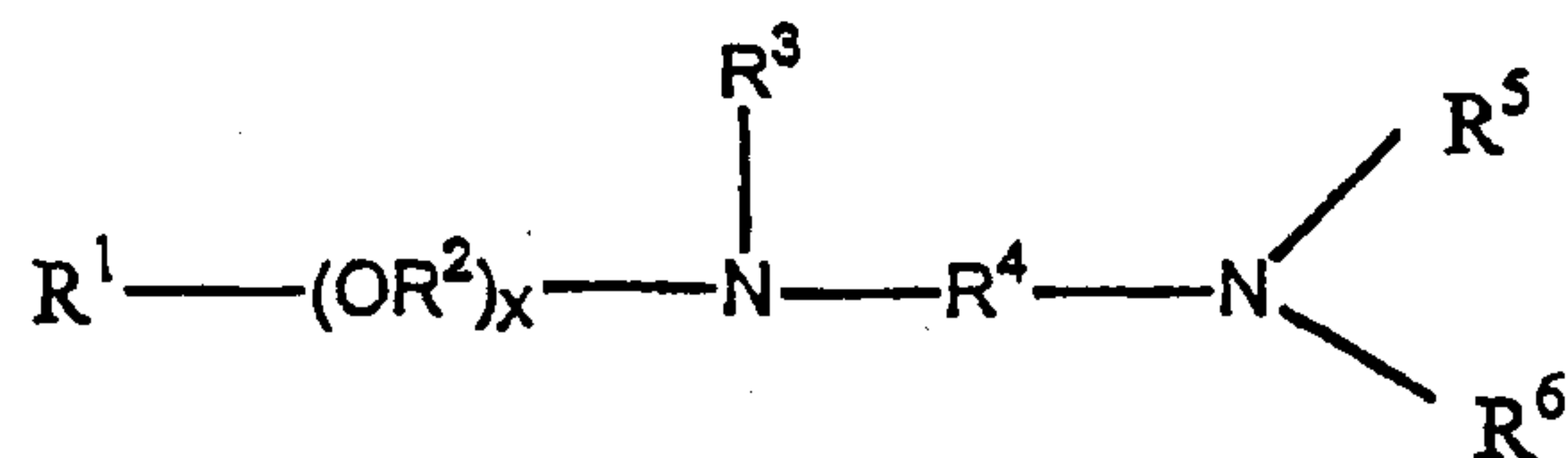

(33)

64725-903 (D)

34

wherein R^1 is hydrocarbyl or substituted hydrocarbyl having from about 8 to about 30 carbon atoms; R^2 in each of the x (R^2O) groups and the y (R^2O) groups is independently C_2 - C_4 alkylene; R^3 , R^5 and R^6 are independently hydrogen, hydrocarbyl or substituted hydrocarbyl having from 1 to about 30 carbon atoms, or $-(R^2O)_yR^7$; R^4 is hydrocarbylene or substituted hydrocarbylene having from 2 to about 6 carbon atoms, $-C(=NR^{11})NR^{12}R^{13}$ -, $-C(=O)NR^{12}R^{13}$ -, $-C(=S)NR^{12}R^{13}$ -, $-C(=NR^{12})$ -, $-C(S)$ -, or $-C(O)$ -; R^7 is hydrogen, or a linear or branched alkyl group having from 1 to about 4 carbon atoms; R^{11} , R^{12} and R^{13} are hydrogen, hydrocarbyl or substituted hydrocarbyl having from 1 to about 30 carbon atoms, x is an average number from 1 to about 30; and y is an average number from 1 to about 50, provided, however, that at least one of R^3 , R^5 and R^6 is $-(R^2O)_yR^7$, at least one R^2 is other than ethylene, R^4 is other than unsubstituted propylene, R^1 is other than unsubstituted alkyl, or x is from 2 to about 30. In this context, preferred R^1 , R^3 , R^4 , R^5 and R^6 hydrocarbyl (hydrocarbylene) groups are linear or branched alkyl (alkylene), linear or branched alkenyl (alkenylene), linear or branched alkynyl (alkynylene), aryl (arylene), or aralkyl (aralkylene) groups. Preferably, R^1 is a linear or branched alkyl or linear or branched alkenyl group having from about 8 to about 22 carbon atoms, R^2 in each of the x (R^2O) groups and the y (R^2O) groups is independently C_2 - C_4 alkylene, R^3 , R^5 and R^6 are independently hydrogen, a linear or branched alkyl or linear or branched alkenyl group having from 1 to about 22 carbon atoms, or $-(R^2O)_yR^7$, R^4 is a linear or branched alkylene, linear or branched alkenylene group having from 2 to about 6 carbon atoms, R^7 is hydrogen, methyl or ethyl, x is an average number from 1 to about 20, and y is an average number from 1 to about 20. More preferably, R^1 is a linear or branched alkyl or linear or branched alkenyl group having from about 8 to about 18 carbon atoms, R^2 in each of the x (R^2O) groups and the y (R^2O) groups is independently ethylene or propylene, R^3 , R^5 and R^6 are independently hydrogen, a linear or branched alkyl group having from 1 to about 6 carbon atoms, or $-(R^2O)_yR^7$, R^4 is ethylene, propylene, or 2-hydroxypropylene, R^7 is hydrogen or methyl, x is an average number from 1 to about 15, and y is an average number from 1 to about 10. Most preferably, R^1 is a linear or branched alkyl or linear or branched alkenyl group having from about 8 to about 18 carbon atoms; R^2 in each of the x (R^2O) groups and the y (R^2O) groups is independently ethylene or propylene; R^3 , R^5 and R^6 are independently hydrogen, methyl, or $-(R^2O)_yR^7$; R^4 is ethylene, propylene, or 2-hydroxypropylene, R^7 is hydrogen, x is

64725-903 (D)

35

an average number from 1 to about 10; and y is an average number from 1 to about 5.

and (i) dialkoxylated amines having the formula:

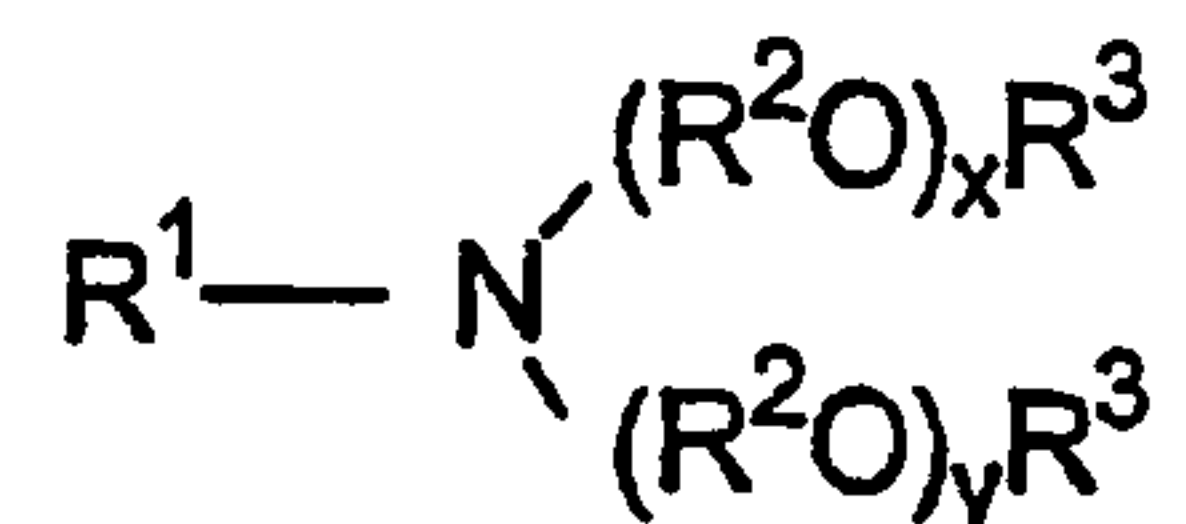

(34)

wherein R^1 is a hydrocarbyl or substituted hydrocarbyl having from about 6 to about 30 carbon atoms, or $-R^4SR^5$, R^4 and R^5 in each of the x (R^2O) and the y (R^2O) groups is independently C_2-C_4 alkylene, R^3 is hydrogen, or a linear or branched alkyl group having from 1 to about 4 carbon atoms, R^5 is a linear or branched alkyl group having from about 4 to about 15 carbon atoms, and x and y are independently an average number from 1 to about 40. In this context, preferred R^1 hydrocarbyl groups are linear or branched alkyl, linear or branched alkenyl, linear or branched alkynyl, aryl, or aralkyl groups. Preferably, R^1 is a linear or branched alkynyl, aryl, or aralkyl group having from about 8 to about 30 carbon atoms, R^2 in each of the x (R^2O) and the y (R^2O) groups is independently C_2-C_4 alkylene, R^3 is hydrogen, methyl or ethyl, and x and y are independently an average number from 1 to about 20. More preferably, R^1 is a linear or branched alkynyl, aryl, or aralkyl group having from about 8 to about 25 carbon atoms, R^2 in each of the x (R^2O) and the y (R^2O) groups is independently ethylene or propylene, R^3 is hydrogen or methyl, and x and y are independently an average number from 1 to about 30. Even more preferably, R^1 is a linear or branched alkynyl, aryl, or aralkyl group having from about 8 to about 22 carbon atoms, R^2 in each of the x (R^2O) and the y (R^2O) groups is independently ethylene or propylene, R^3 is hydrogen or methyl, and x and y are independently an average number from 1 to about 5.

Nonionic surfactants for use in pesticide formulations include dialkoxylated alcohols having the formula:

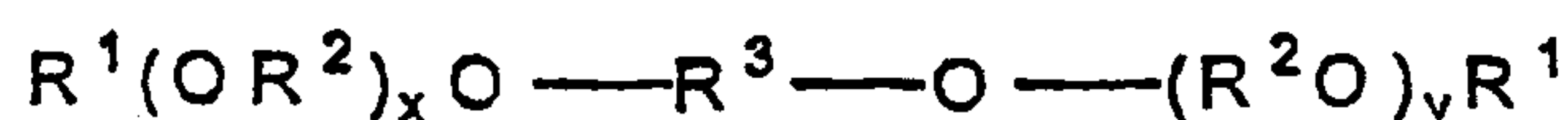

(35)

wherein R^1 is independently hydrogen, or a linear or branched alkyl group having from 1 to about 4 carbon atoms, R^2 in each of the x (R^2O) and the y (R^2O) groups is independently C_2-C_4 alkylene, R^3 is hydrocarbylene or substituted

64725-903 (D)

36

hydrocarbylene having from 2 to about 30 carbon atoms, and x and y are independently an average number from 1 to about 60. In this context, preferred R^3 hydrocarbylene groups are linear or branched alkylene, linear or branched alkenylene, linear or branched alkynylene, arylene, or aralkylene groups. Preferably, R^1 is hydrogen, methyl or ethyl, R^2 in each of the x (R^2O) and the y (R^2O) groups is independently C_2-C_4 alkylene, R^3 is a linear or branched alkylene or linear or branched alkenylene group having from about 8 to about 25 carbon atoms, and x and y are independently an average number from about 1 to about 20. More preferably, R^1 is hydrogen or methyl, R^2 in each of the x (R^2O) and the y (R^2O) groups is independently ethylene or propylene, R^3 is a linear or branched alkylene or linear or branched alkenylene group having from about 8 to about 18 carbon atoms, and x and y are independently an average number from 1 to about 10. Even more preferably, R^1 is hydrogen, R^2 in each of the x (R^2O) and the y (R^2O) groups is independently ethylene or propylene, R^3 is a linear or branched alkylene group having from about 8 to about 18 carbon atoms, and x and y are independently an average number from 1 to about 5.

Other surfactants for use in pesticide compositions include compounds of the formula:

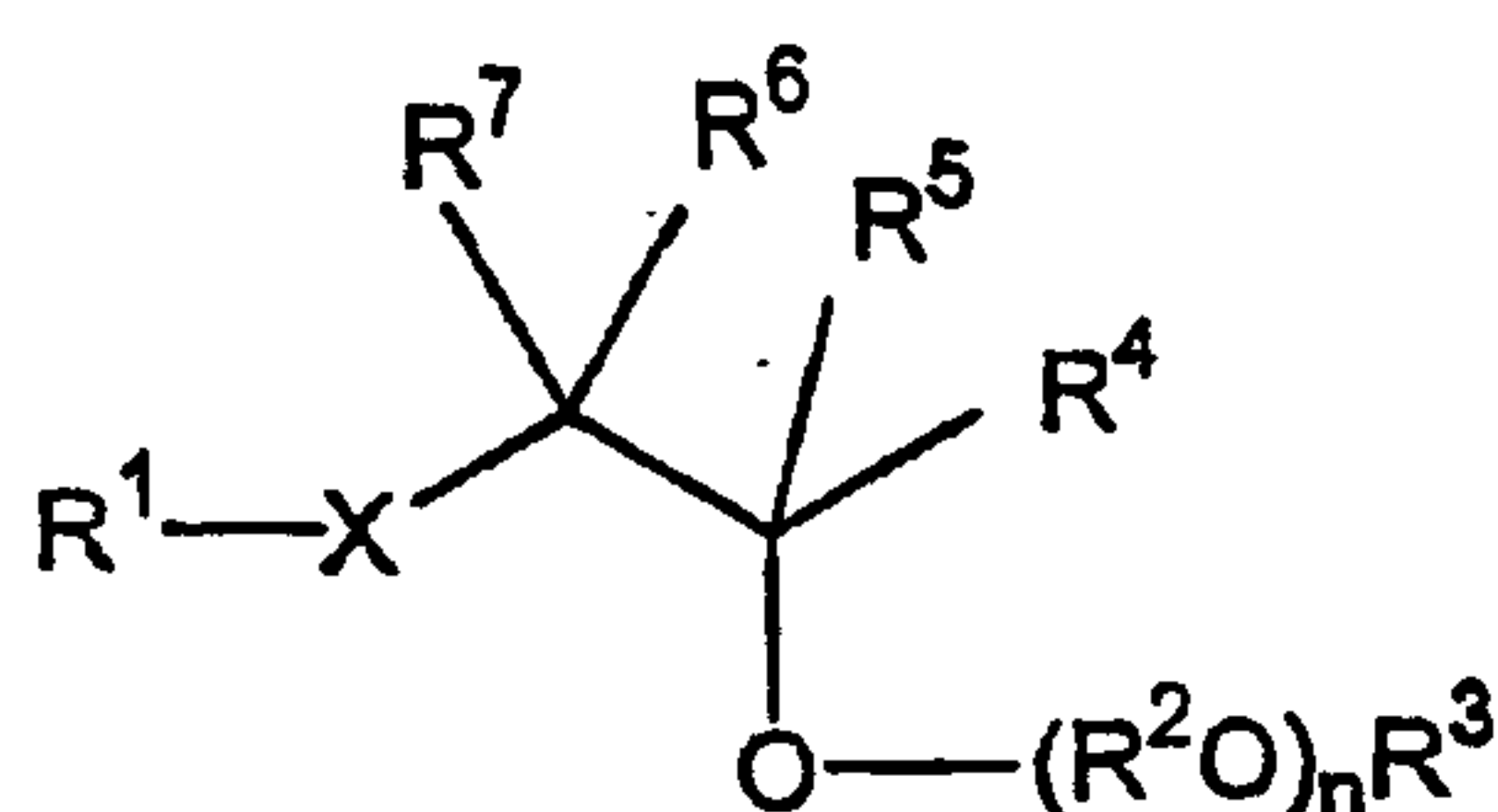

(36)

or

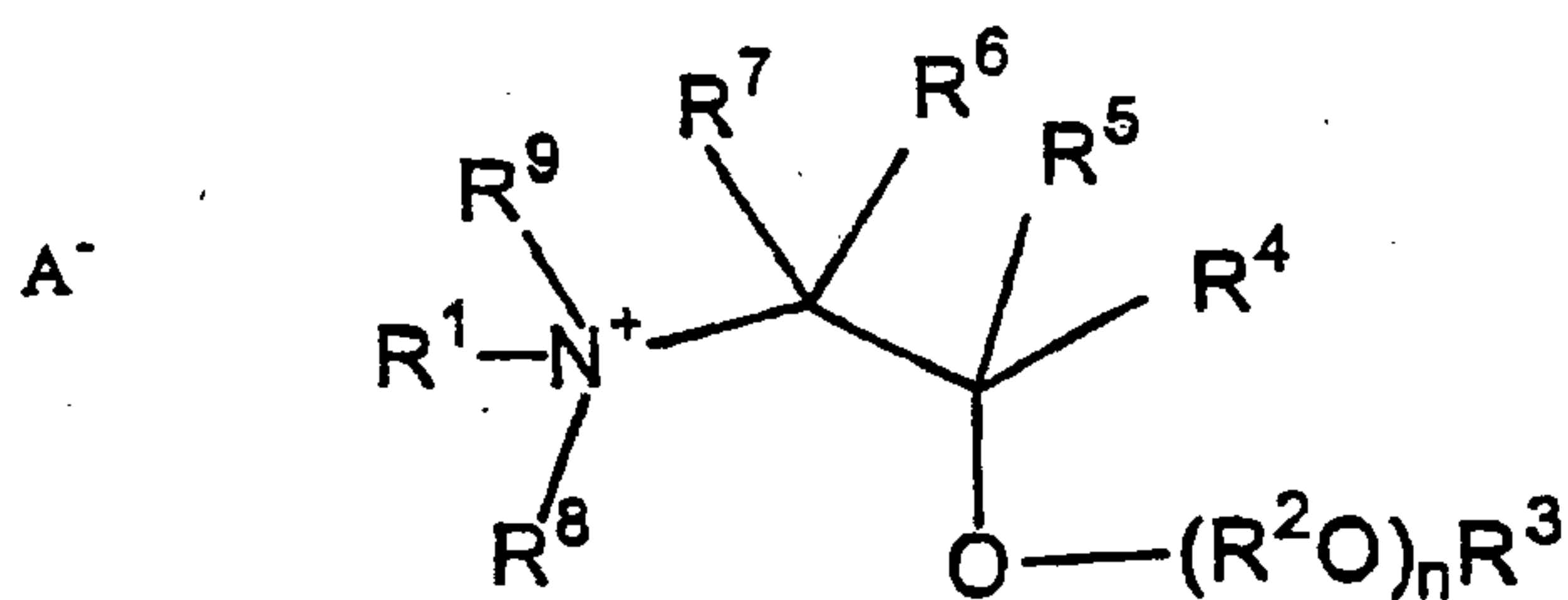

(37)

64725-903 (D)

37

or

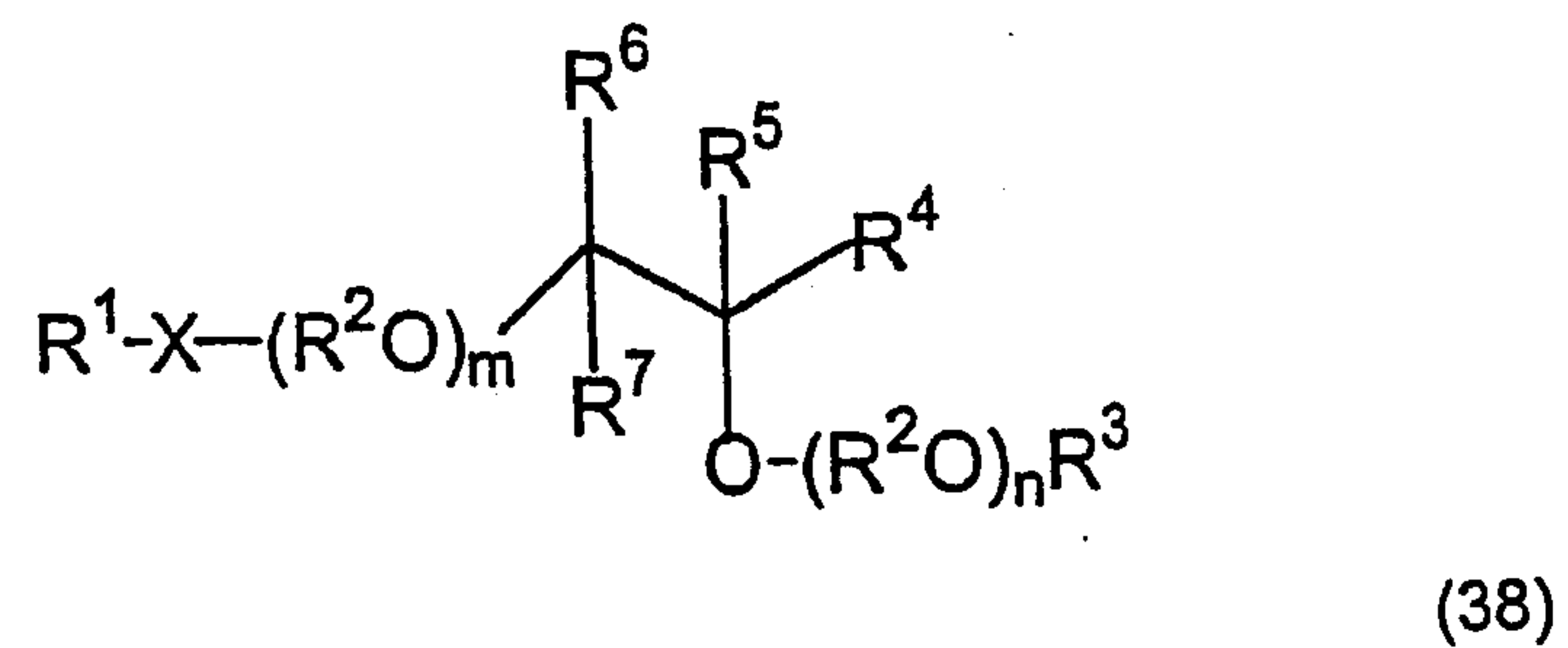

or

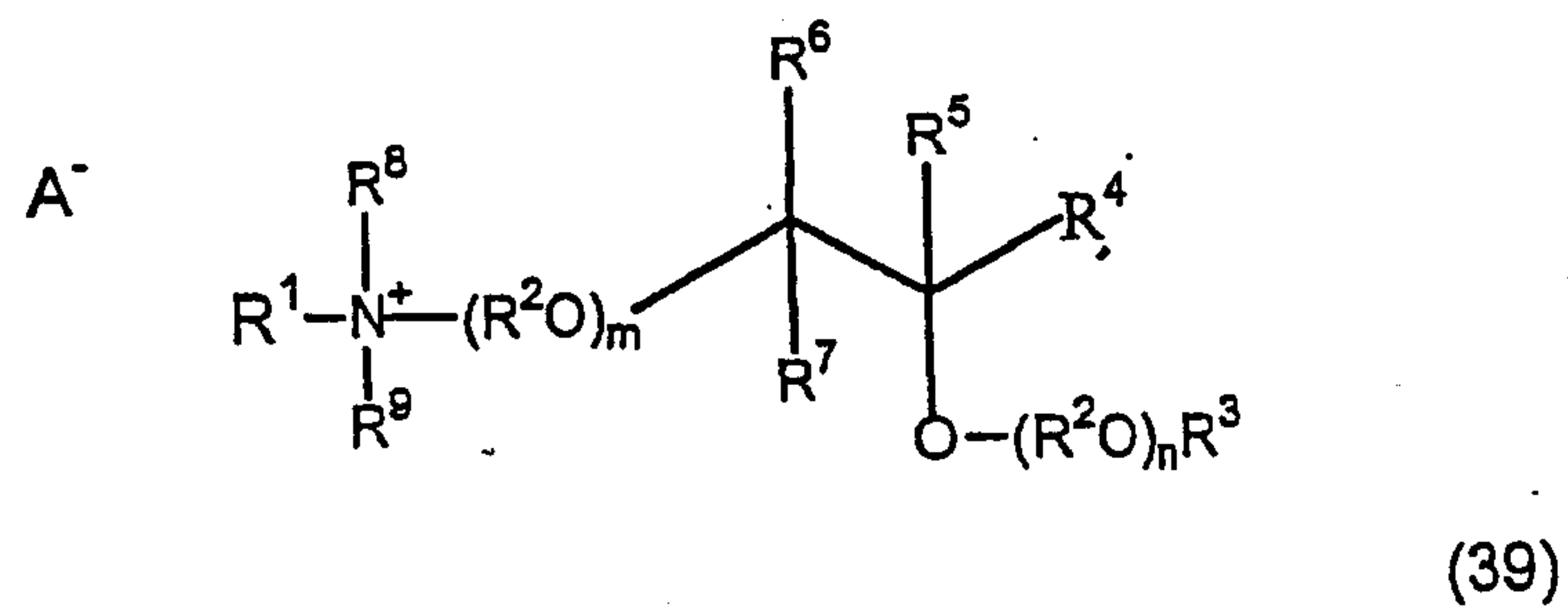

or

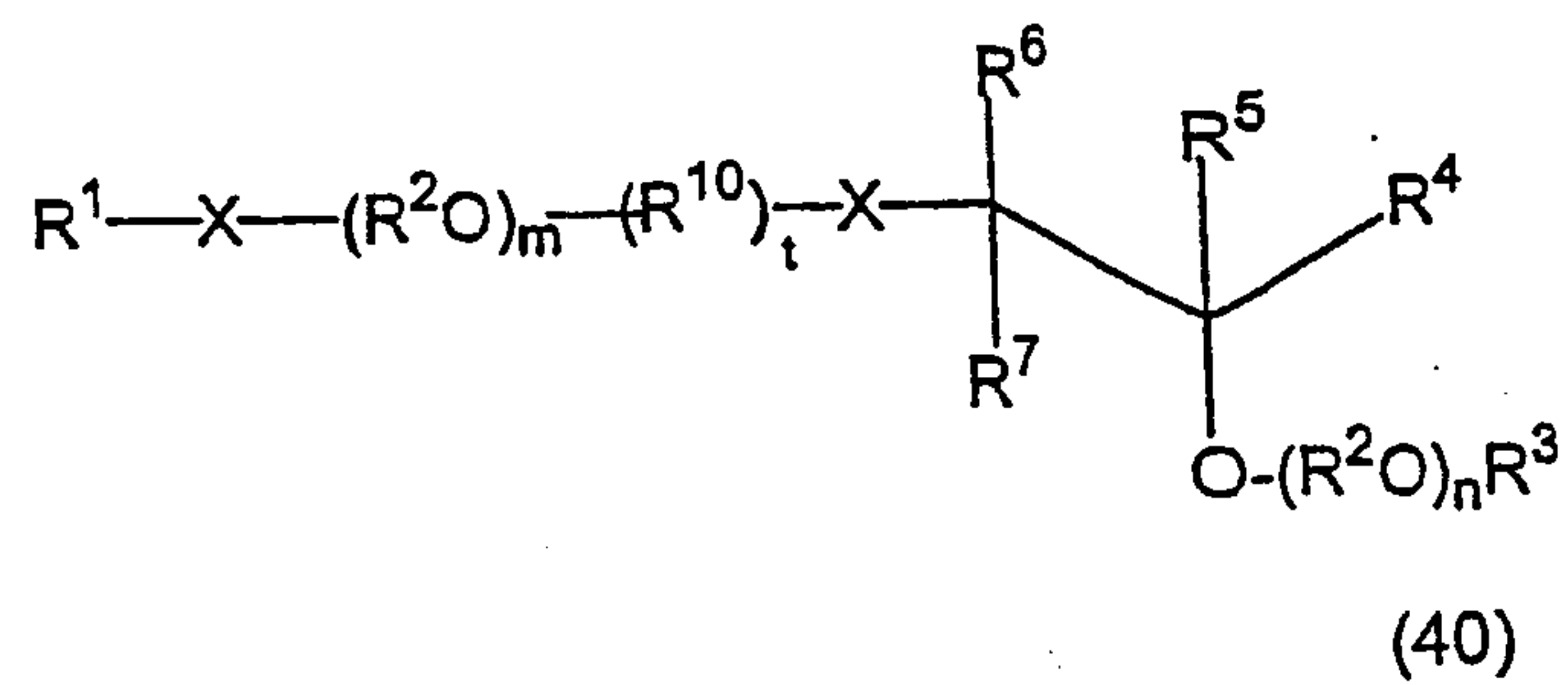

or

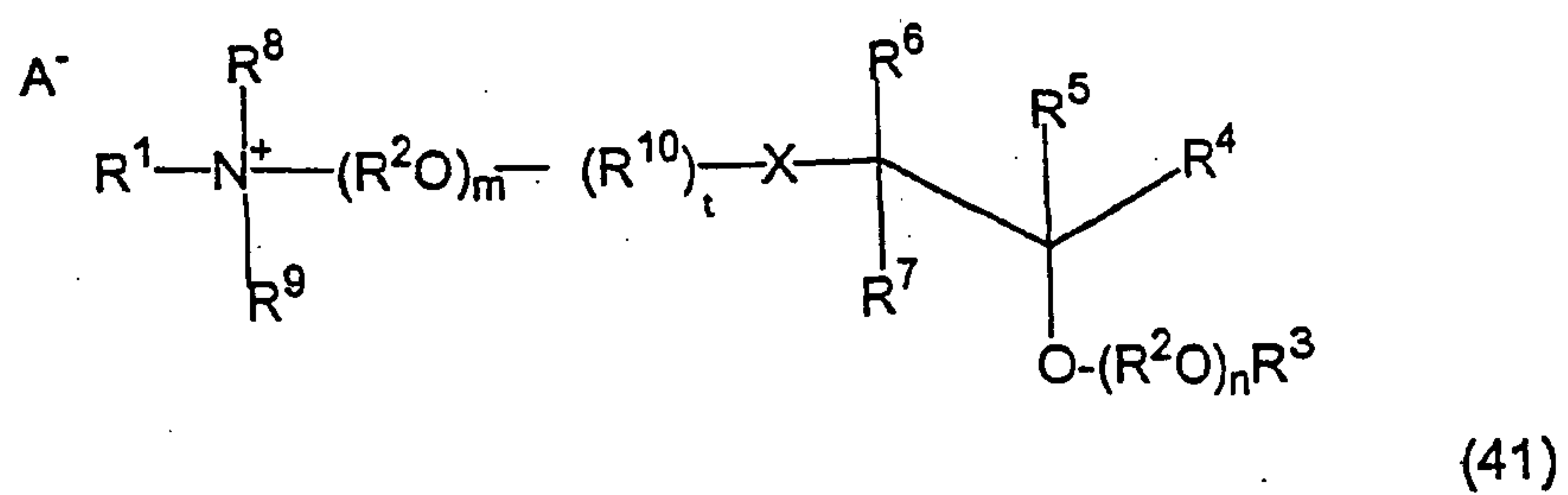

or

64725-903 (D)

38

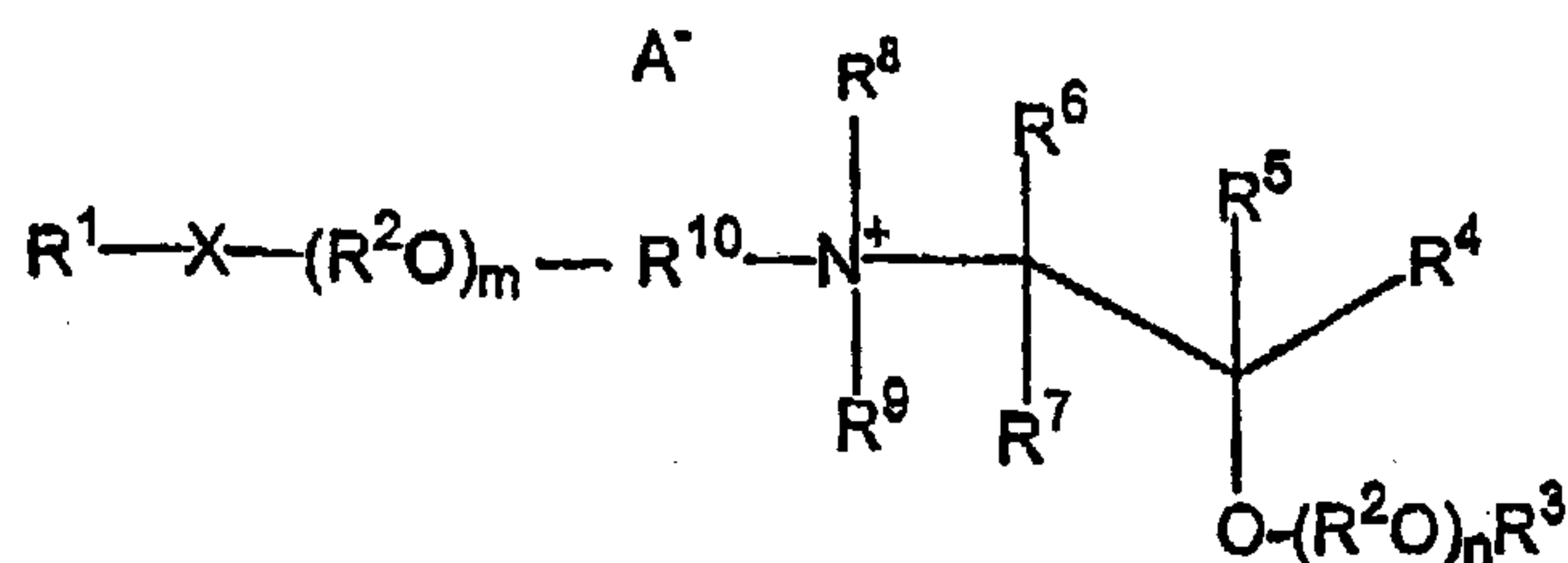

(42)

or

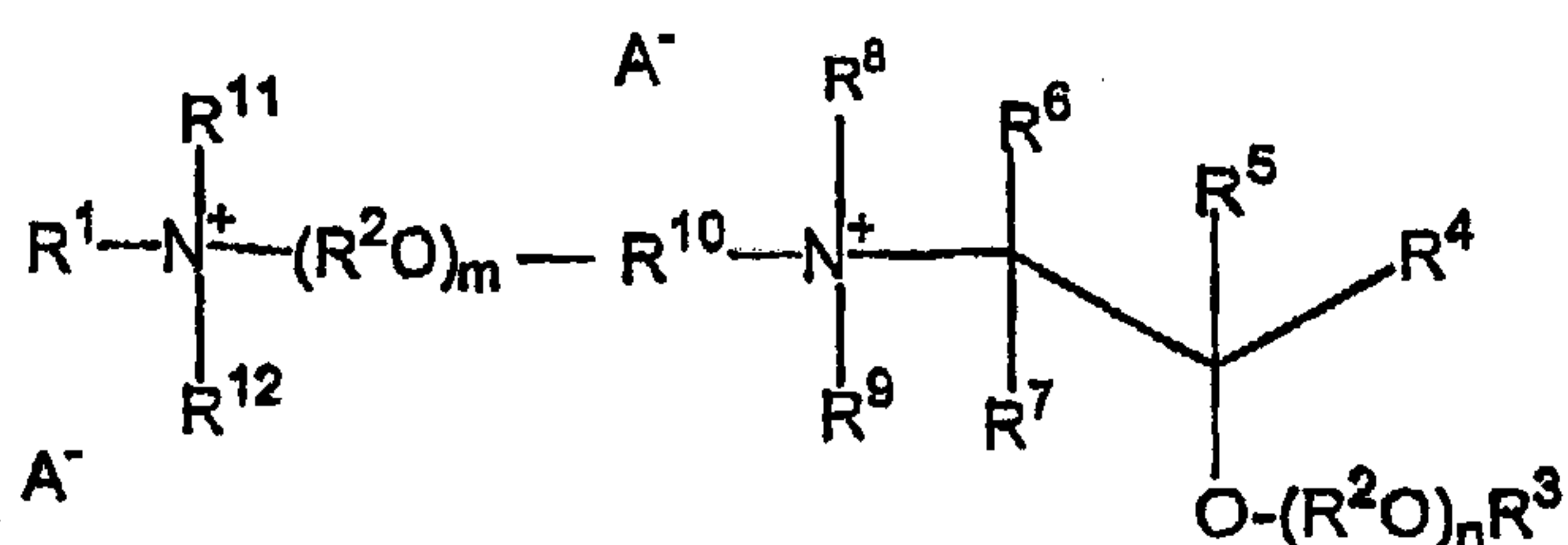

(43)

wherein R^1 , R^9 , and R^{12} are independently hydrocarbyl or substituted hydrocarbyl having from 1 to about 30 carbon atoms, or $-(\text{R}^2\text{O})_p\text{R}^{13}$; R^2 in each of the m (R^2O) , n (R^2O) , p (R^2O) and q (R^2O) groups is independently C_2 - C_4 alkylene; R^3 , R^8 , R^{11} , R^{13} and R^{15} are independently hydrogen, or a hydrocarbyl or substituted hydrocarbyl having from 1 to about 30 carbon atoms; R^4 is $-(\text{CH}_2)_y\text{OR}^{13}$ or $-(\text{CH}_2)_y\text{O}(\text{R}^2\text{O})_q\text{R}^3$; R^5 , R^6 and R^7 are independently hydrogen, hydrocarbyl or substituted hydrocarbyl having from 1 to about 30 carbon atoms, or R^4 ; R^{10} is hydrocarbylene or substituted hydrocarbylene having from 2 to about 30 carbon atoms; R^{14} is hydrocarbyl or substituted hydrocarbyl having from 1 to about 30 carbon atoms, or $-(\text{CH}_2)_z\text{O}(\text{R}^2\text{O})_p\text{R}^3$; m , n , p and q are independently an average number from 1 to about 50; X is $-\text{O}-$, $-\text{N}(\text{R}^{14})-$, $-\text{C}(\text{O})-$, $-\text{C}(\text{O})\text{O}-$, $-\text{OC}(\text{O})-$, $-\text{N}(\text{R}^{15})\text{C}(\text{O})-$, $-\text{C}(\text{O})\text{N}(\text{R}^{15})-$, $-\text{S}-$, $-\text{SO}-$, or $-\text{SO}_2-$; t is 0 or 1; A^- is an agriculturally acceptable anion; and y and z are independently an integer from 0 to about 30. In this context, preferred R^1 , R^3 , and R^5 - R^{15} hydrocarbyl (hydrocarbylene) groups are linear or branched alkyl (alkylene), linear or branched alkenyl (alkenylene), linear or branched alkynyl (alkynylene), aryl (arylene), or aralkyl (aralkylene) groups. Preferably, R^1 , R^9 , and R^{12} are independently linear or branched alkyl or alkenyl groups having from 1 to about 22 carbon atoms, or $-(\text{R}^2\text{O})_p\text{R}^{13}$; R^2 in each of the m (R^2O) , n (R^2O) , p (R^2O) and q (R^2O) groups is independently C_2 - C_4

64725-903 (D)

39

alkylene; R^3 is hydrogen, methyl or ethyl; R^4 is $-(CH_2)_yOR^{13}$ or $-(CH_2)_yO(R^2O)_qR^3$; R^8 , R^{11} , R^{13} and R^{15} are independently hydrogen, or linear or branched alkyl or alkenyl groups having from 1 to about 22 carbon atoms; R^4 is $-(CH_2)_yOR^{13}$ or $-(CH_2)_yO(R^2O)_qR^3$; R^5 , R^6 and R^7 are independently hydrogen, linear or branched alkyl or alkenyl groups having from 1 to about 22 carbon atoms, or R^4 ; R^{10} is a linear or branched alkylene or alkenylene group having from 2 to about 18 carbon atoms; R^{14} is a linear or branched alkyl or alkenyl group having from 1 to about 22 carbon atoms, or $-(CH_2)_2O(R^2O)_pR^3$; m , n , p and q are independently an average number from 1 to about 30; X is $-O-$, $-N(R^{14})-$, $-C(O)-$, $-C(O)O-$, $-OC(O)-$, $-N(R^{15})C(O)-$, $-C(O)N(R^{15})-$, $-S-$, $-SO-$, or $-SO_2-$, t is 0 or 1; $A-$ is an agriculturally acceptable anion; and y and z are independently an integer from 0 to about 30. More preferably, R^1 is a linear or branched alkyl or alkenyl groups having from about 8 to about 18 carbon atoms, or $-(R^2O)_pR^{13}$; R^9 and R^{12} are independently linear or branched alkyl or alkenyl groups having from 1 to about 22 carbon atoms, or $-(R^2O)_pR^{13}$; R^2 in each of the m (R^2O) , n (R^2O) , p (R^2O) and q (R^2O) groups is independently ethylene or propylene; R^3 is hydrogen or methyl; R^4 is $-(CH_2)_yOR^{13}$ or $-(CH_2)_yO(R^2O)_qR^3$; R^8 , R^{11} , R^{15} are independently hydrogen, or linear or branched alkyl or alkenyl groups having from 1 to about 22 carbon atoms; R^4 is $-(CH_2)_yOR^{13}$ or $-(CH_2)_yO(R^2O)_qR^3$; R^5 , R^6 and R^7 are independently hydrogen, linear or branched alkyl or alkenyl groups having from 1 to about 22 carbon atoms, or R^4 ; R^{10} is a linear or branched alkylene or alkenylene group having from 2 to about 6 carbon atoms; R^{13} is hydrogen, or linear or branched alkyl or alkenyl groups having from about 6 to about 22 carbon atoms; R^{14} is a linear or branched alkyl or alkenyl group having from 1 to about 22 carbon atoms, or $-(CH_2)_2O(R^2O)_pR^3$; m , n , p and q are independently an average number from 1 to about 20; X is $-O-$, $-N(R^{14})-$, $-C(O)-$, $-C(O)O-$, $-OC(O)-$, $-N(R^{15})C(O)-$, $-C(O)N(R^{15})-$, $-S-$, $-SO-$, or $-SO_2-$, t is 0 or 1; $A-$ is an agriculturally acceptable anion; and y and z are independently an integer from 0 to about 10. Most preferably, R^1 is a linear or branched alkyl or alkenyl groups having from about 12 to about 18 carbon atoms, or $-(R^2O)_pR^{13}$; R^9 and R^{12} are independently linear or branched alkyl or alkenyl groups having from 1 to about 6 carbon atoms, or $-(R^2O)_pR^{13}$; R^2 in each of the m (R^2O) , n (R^2O) , p (R^2O) and q (R^2O) groups is independently ethylene or propylene; R^3 is hydrogen; R^4 is $-(CH_2)_yOR^{13}$ or $-(CH_2)_yO(R^2O)_qR^3$; R^8 , R^{11} , R^{15} are independently hydrogen, or linear or branched alkyl or alkenyl groups having from 1 to about 6 carbon atoms; R^4 is $-(CH_2)_yOR^{13}$ or $-(CH_2)_yO(R^2O)_qR^3$; R^5 , R^6 and R^7 are independently hydrogen, linear or

64725-903 (D)

40

branched alkyl or alkenyl groups having from 1 to about 22 carbon atoms, or R^4 ; R^{10} is a linear or branched alkylene or alkenylene group having from 2 to about 6 carbon atoms; R^{13} is hydrogen, or linear or branched alkyl or alkenyl groups having from about 6 to about 22 carbon atoms; R^{14} is a linear or branched alkyl or alkenyl group having from 1 to about 22 carbon atoms, or $-(CH_2)_2O(R^2O)_pR^3$; m , n , p and q are independently an average number from 1 to about 5; X is $-O-$ or $-N(R^{14})-$, t is 0 or 1; A^- is an agriculturally acceptable anion; and y and z are independently an integer from 1 to about 3.

A surfactant composition of the invention comprises any individual combination of the novel surfactants as described above. The surfactant composition is particularly preferred for use in formulating potassium, di-ammonium, ammonium, sodium, monoethanolamine, n-propylamine, methylamine, ethylamine, hexamethylenediamine, dimethylamine and/or trimethylsulfonium glyphosate formulations, such as aqueous concentrates. The surfactant composition can be incorporated into a formulation comprising any combination of these glyphosate salts.

Various surfactants not previously used in formulating pesticide compositions have been found to be effective, particularly in formulating aqueous herbicidal concentrates containing potassium or ammonium glyphosate. Cationic surfactants effective in forming pesticide formulations include:

(a) aminated alkoxyated alcohol having the formula:

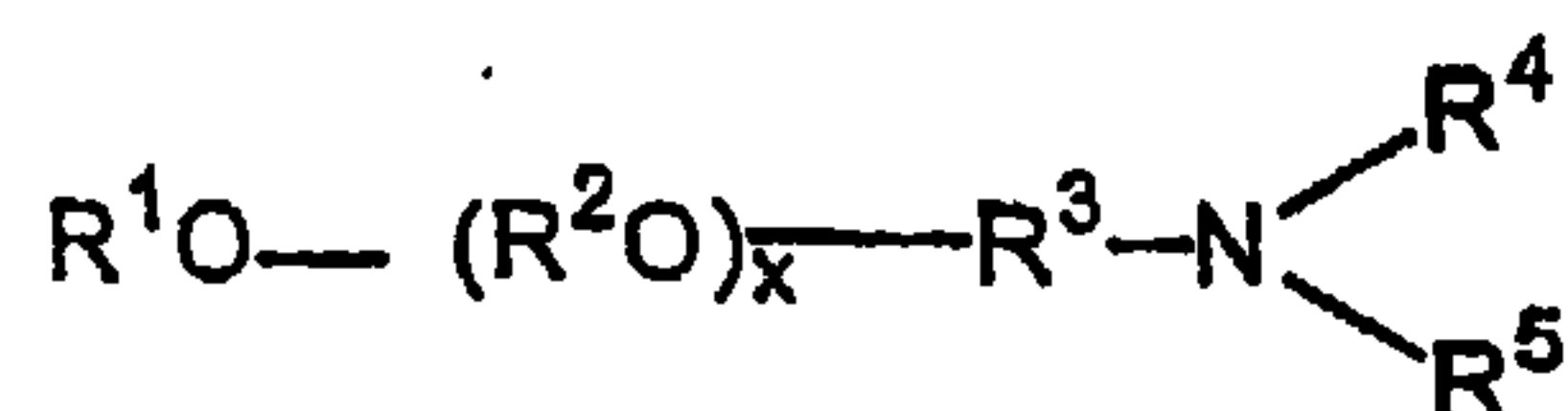

(44)

or

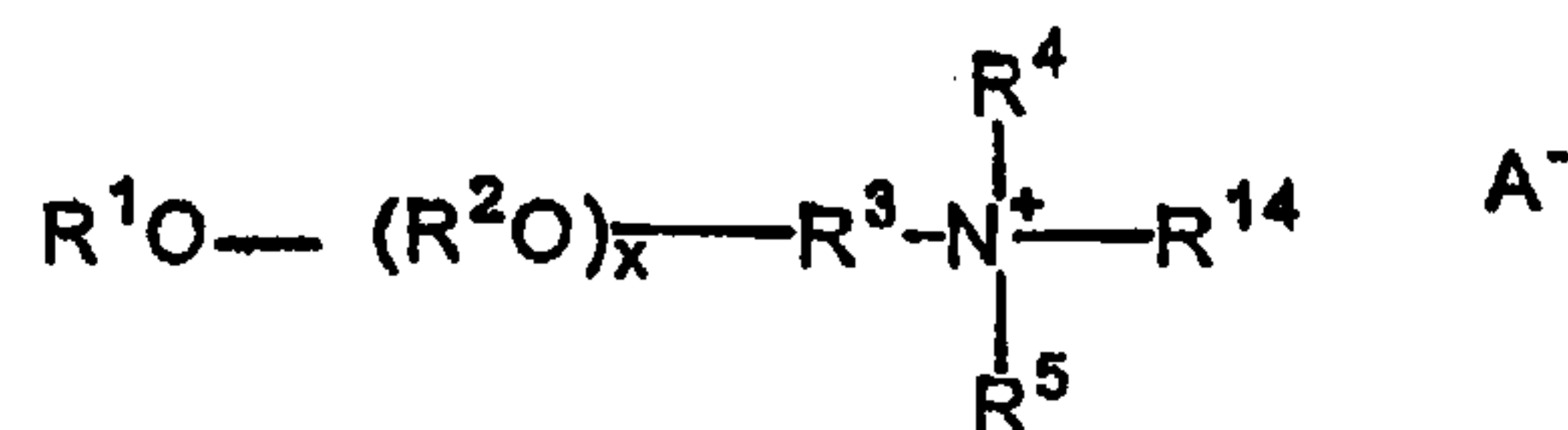

(45)

wherein R^1 is hydrocarbyl or substituted hydrocarbyl containing at least 7 carbon atoms (preferably containing 8 to about 30 carbon atoms); R^2 in each of the x (R^2O) and y (R^2O) groups is independently C_2 - C_4 alkylene; R^3 and R^5 are each

64725-903 (D)

41

independently hydrocarbylene or substituted hydrocarbylene having from 1 to about 6 carbon atoms; R^4 is hydrogen, hydrocarbyl or substituted hydrocarbyl having from 1 to about 30 carbon atoms, hydroxy substituted hydrocarbyl, $-(R^6)_n-(R^2O)_yR^7$, $-C(=NR^{11})NR^{12}R^{13}$, $-C(=O)NR^{12}R^{13}$, $-C(=S)NR^{12}R^{13}$ or together with R^5 and the nitrogen atom to which they are attached, form a cyclic or heterocyclic ring; R^5 is hydrogen, hydrocarbyl or substituted hydrocarbyl having from 1 to about 30 carbon atoms, hydroxy substituted hydrocarbyl, $-(R^6)_n-(R^2O)_yR^7$, $-C(=NR^{11})NR^{12}R^{13}$, $-C(=O)NR^{12}R^{13}$, $-C(=S)NR^{12}R^{13}$, or together with R^4 and the nitrogen atom to which they are attached, form a cyclic or heterocyclic ring; R^7 is hydrogen or a linear or branched alkyl group having 1 to about 4 carbon atoms; R^{11} , R^{12} and R^{13} are hydrogen, hydrocarbyl or substituted hydrocarbyl, R^{14} is hydrogen, hydrocarbyl or substituted hydrocarbyl having from 1 to about 30 carbon atoms, hydroxy substituted hydrocarbyl, $-(R^6)_n-(R^2O)_yR^7$, $-C(=NR^{11})NR^{12}R^{13}$, $-C(=O)NR^{12}R^{13}$, or $-C(=S)NR^{12}R^{13}$, n is 0 or 1, x and y are independently an average number from 1 to about 60, and A^- is an agriculturally acceptable anion, provided, however, that when R^2 and R^3 are isopropylene and x is 1, R^1 is other than alkyl or R^4 is other than $-(R^2O)_yR^7$. In this context, preferred R^1 , R^3 , R^4 , R^5 , R^6 , R^{11} , R^{12} and R^{13} hydrocarbyl (hydrocarbylene) groups are linear or branched alkyl (alkylene), linear or branched alkenyl (alkenylene), linear or branched alkynyl (alkynylene), aryl (arylene), or aralkyl (aralkylene) groups. In one embodiment, R^3 is linear alkylene, preferably ethylene, and R^1 , R^2 , R^4 and R^5 are as previously defined. In another embodiment, R^4 is H, alkyl, or $-R^2OR^7$ and R^1 , R^2 , R^3 , R^5 and R^7 are as previously defined. In yet another embodiment, R^1 is a linear or branched alkyl or linear or branched alkenyl group having from about 8 to about 25 carbon atoms, R^2 in each of the x (R^2O) groups is independently C_2 - C_4 alkylene, R^3 is a linear or branched alkylene group having from 1 to about 6 carbon atoms, R^4 and R^5 are each independently hydrogen or a linear or branched alkyl group having from 1 to about 6 carbon atoms, and x is an average number from about 2 to about 30. More preferably, R^1 is a linear or branched alkyl group having from about 12 to about 22 carbon atoms, R^2 in each of the x (R^2O) groups is independently ethylene or propylene, R^3 is a linear or branched alkylene group having from 1 to about 4 carbon atoms, R^4 and R^5 are each independently hydrogen, methyl, or tris(hydroxymethyl)methyl, and x is an average number from about 2 to about 30. Even more preferably, R^1 is a linear or branched alkyl group having from about 12 to about 18 carbon atoms, R^2 in each of the x (R^2O) groups is independently ethylene or propylene, R^3 is ethylene, R^4

64725-903 (D)

42

and R^5 are each independently hydrogen or methyl, and x is an average number from about 4 to about 20. Most preferably, R^1 is a linear or branched alkyl group having from about 12 to about 18 carbon atoms, R^2 in each of the x (R^2O) groups is independently ethylene or propylene, R^3 is ethylene, R^4 and R^5 are methyl, and x is an average number from about 4 to about 20. Compounds of formula (45) have the preferred groups as described above and R^{14} is preferably hydrogen or a linear or branched alkyl or alkenyl group, more preferably alkyl, and most preferably methyl. Preferred monoalkoxylated amines include PEG 13 or 18 C_{14-15} ether propylamines and PEG 7, 10, 15 or 20 C_{16-18} ether propylamines (from Tomah) and PEG 13 or 18 C_{14-15} ether dimethyl propylamines and PEG 10, 15 or 20 or 25 C_{16-18} ether dimethyl propylamines (from Tomah).

(b) hydroxylated amines having the formula:

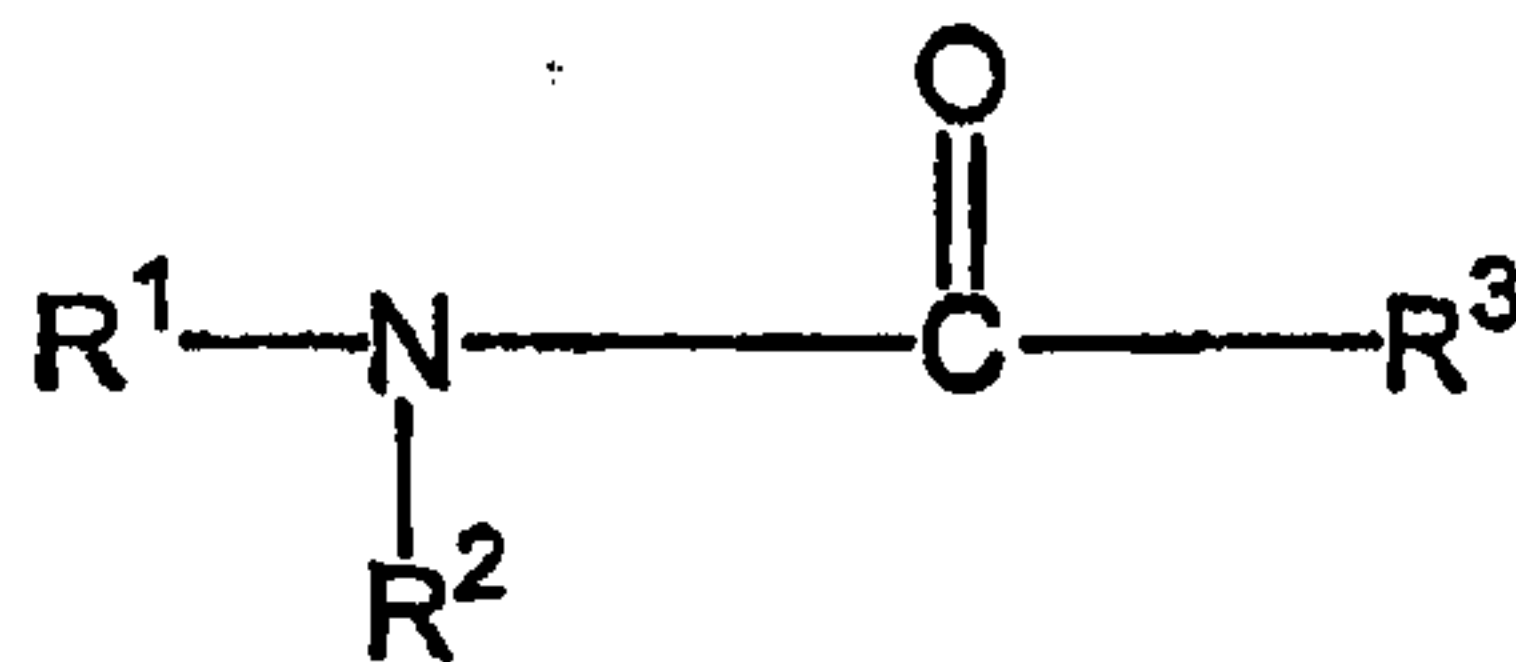

(46)

wherein R^1 is hydrocarbyl or substituted hydrocarbyl having from about 4 to about 30 carbon atoms, R^2 is hydrogen or hydrocarbyl or substituted hydrocarbyl having from 1 to about 30 carbon atoms, and R^3 is hydroxyalkyl, polyhydroxyalkyl, or poly(hydroxyalkyl)alkyl. In this context, preferred R^1 and R^2 hydrocarbyl groups are linear or branched alkyl, linear or branched alkenyl, linear or branched alkynyl, aryl, or aralkyl groups. Preferably, the hydroxylated amines have the formula:

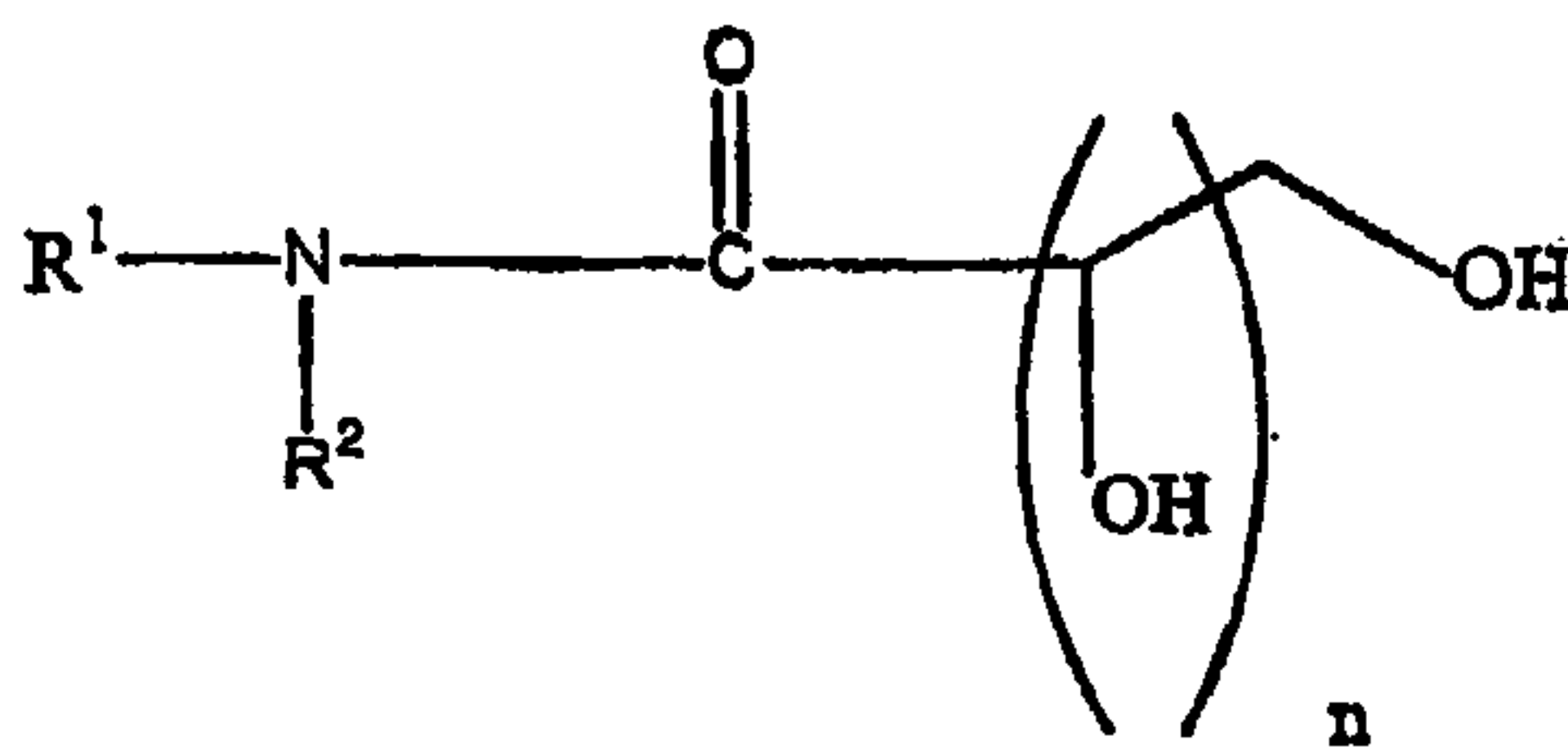

(47)

wherein R^1 is hydrocarbyl or substituted hydrocarbyl having from about 4 to about 30 carbon atoms, R^2 is hydrogen or hydrocarbyl or substituted hydrocarbyl having from 1 to about 30 carbon atoms, and n is 1 to about 8. In this context, preferred R^1 and R^2 hydrocarbyl groups are linear or branched alkyl, linear or branched

64725-903 (D)

43

alkenyl, linear or branched alkynyl, aryl, or aralkyl groups. Preferably, R¹ is a linear or branched alkyl or linear or branched alkenyl group having from about 8 to about 30 carbon atoms, R² is hydrogen, a linear or branched alkyl or linear or branched alkenyl group having from 1 to about 30 carbon atoms, and n is about 4 to about 8; or R¹ and R² are independently linear or branched alkyl or linear or branched alkenyl groups having from about 4 to about 30 carbon atoms and n is about 4 to about 8. More preferably, R¹ is a linear or branched alkyl or linear or branched alkenyl group having from about 8 to about 22 carbon atoms, R² is hydrogen or a linear or branched alkyl or linear or branched alkenyl group having from 1 to about 6 carbon atoms, and n is about 4 to about 8; or R¹ and R² are independently linear or branched alkyl or linear or branched alkenyl groups having from about 4 to about 8 carbon atoms, and n is about 4 to about 8.

(c) diamines having the formula:

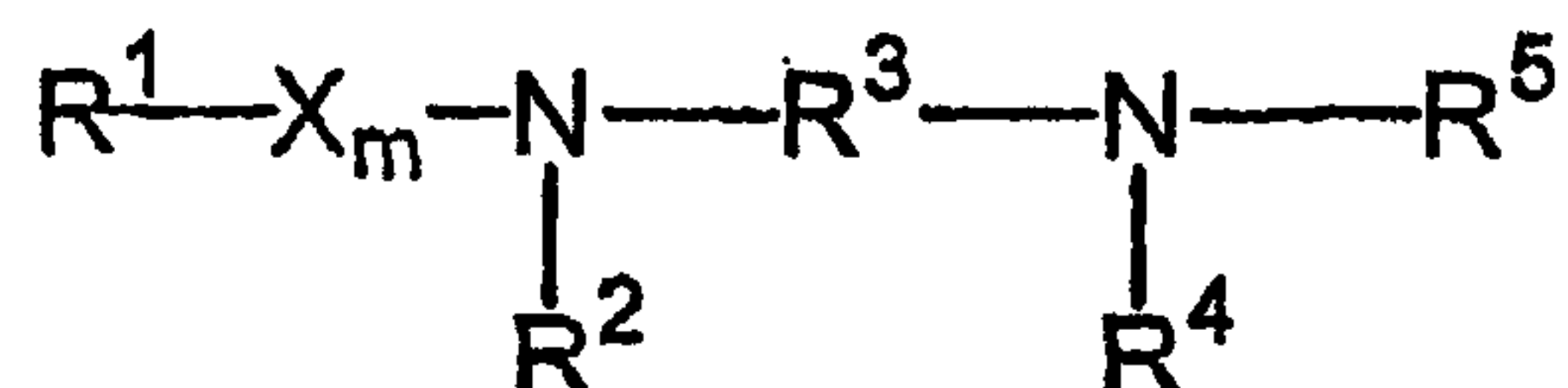

(48)

wherein R¹, R² and R⁵ are independently hydrogen or hydrocarbyl or substituted hydrocarbyl having from 1 to about 30 carbon atoms or -R⁶(OR⁹)_nOR¹⁰, R³ is hydrocarbylene or substituted hydrocarbylene having from 2 to about 18 carbon atoms, R⁶ and R⁹ are individually hydrocarbylene or substituted hydrocarbylene having from 2 to about 4 carbon atoms, R⁴ and R¹⁰ are independently hydrogen or hydrocarbyl or substituted hydrocarbyl having from 1 to about 30 carbon atoms, m is 0 or 1, n is an average number from 0 to about 40, X is -C(O)- or -SO₂-, and A⁻ is an agriculturally acceptable anion. In this context, preferred R¹, R³, R⁴ and R⁵ hydrocarbyl (hydrocarbylene) groups are linear or branched alkyl (alkylene), linear or branched alkenyl (alkenylene), linear or branched alkynyl (alkynylene), aryl (arylene), or aralkyl (aralkylene) groups. Preferably, R¹, R², R⁴ and R⁵ are independently hydrogen, a linear or branched alkyl or alkenyl group having from 1 to about 6 carbon atoms, and R³ is a linear or branched alkylene having from 2 to about 6 carbon atoms. More preferably, R¹, R², R⁴ and R⁵ are independently hydrogen, or a linear or branched alkyl group having from 1 to about 6 carbon atoms, and R³ is a linear or branched alkylene having from 1 to about 6 carbon

64725-903 (D)

44

atoms. Most preferably, R^1 , R^2 , R^4 , and R^5 are independently hydrogen or methyl, and R^3 is ethylene or propylene.

(d) mono- or di-ammonium salts having the formula:

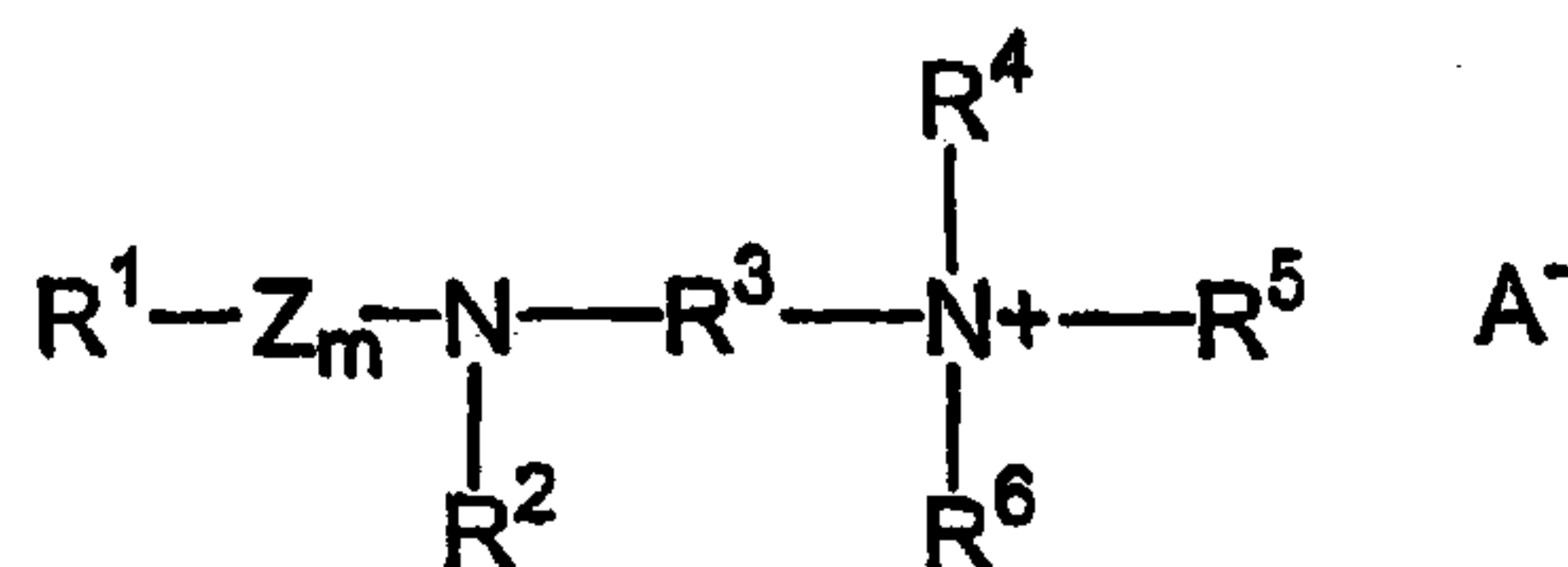

(49)

or

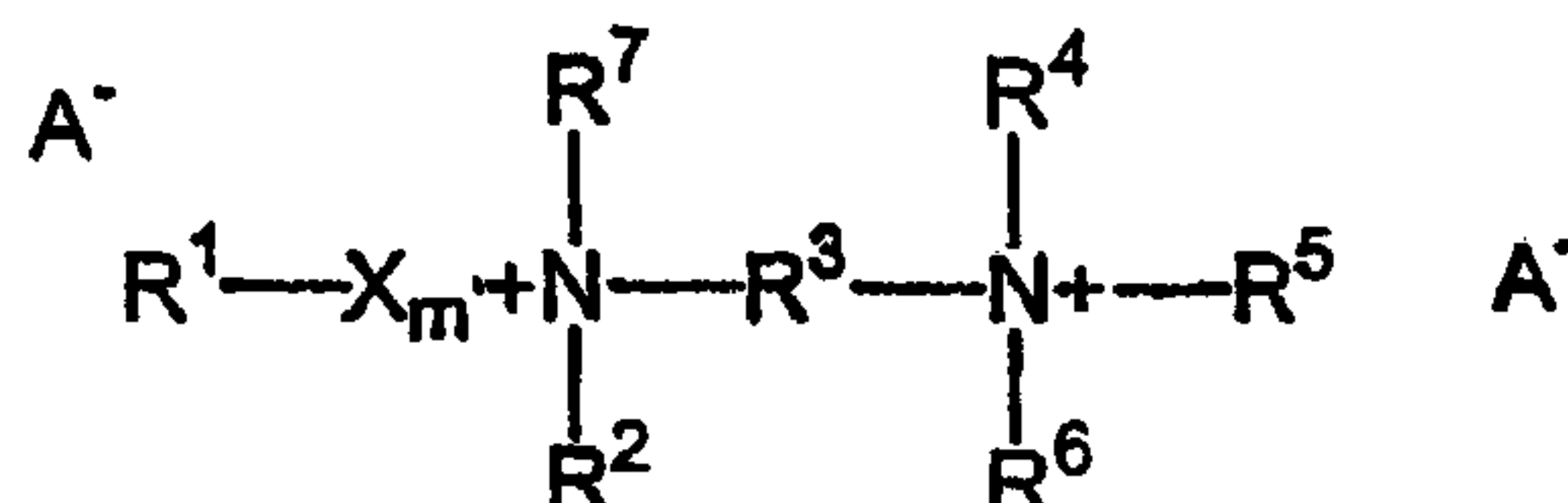

(50)

wherein R^1 , R^2 , R^4 , R^5 and R^7 are independently hydrogen or hydrocarbyl or substituted hydrocarbyl having from 1 to about 30 carbon atoms or - $R^8(OR^9)_nOR^{10}$, R^6 is hydrocarbyl or substituted hydrocarbyl having from about 1 to about 30 carbon atoms, R^3 is hydrocarbylene or substituted hydrocarbylene having from 2 to about 18 carbon atoms, R^8 , R^9 and R^{11} are individually hydrocarbylene or substituted hydrocarbylene having from 2 to about 4 carbon atoms, R^{10} is hydrogen or hydrocarbyl or substituted hydrocarbyl having from 1 to about 30 carbon atoms, m is 0 or 1, n is an average number from 0 to about 40, X is $-C(O)-$ or $-SO_2-$, Z is $-C(O)-$, and A^- is an agriculturally acceptable anion. In this context, preferred R^1 , R^3 , R^4 , R^5 , and R^7 hydrocarbyl (hydrocarbylene) groups are linear or branched alkyl (alkylene), linear or branched alkenyl (alkenylene), linear or branched alkynyl (alkynylene), aryl (arylene), or aralkyl (aralkylene) groups. Preferably, R^1 , R^2 , R^4 , R^5 and R^7 are independently hydrogen, a linear or branched alkyl or alkenyl group having from 1 to about 6 carbon atoms, R^6 is a linear or branched alkyl or alkenyl group having from about 8 to about 30 carbon atoms, m is 0 or 1, and R^3 is a linear or branched alkylene having from 2 to about 6 carbon atoms. More preferably, R^1 , R^2 , R^4 , R^5 and R^7 are independently hydrogen, or a linear or branched alkyl group having from 1 to about 6 carbon atoms, R^6 is a linear or branched alkyl group having from about 8 to about 22 carbon atoms, m

64725-903 (D)

45

is 0 or 1, and R^3 is a linear or branched alkylene having from 1 to about 6 carbon atoms. Most preferably, R^1 , R^2 , R^4 , R^6 and R^7 are independently hydrogen or methyl, R^5 is a linear or branched alkyl group having from about 8 to about 18 carbon atoms, m is 0 or 1, and R^9 is ethylene or propylene.

(e) poly(hydroxyalkyl)amines having the formula:

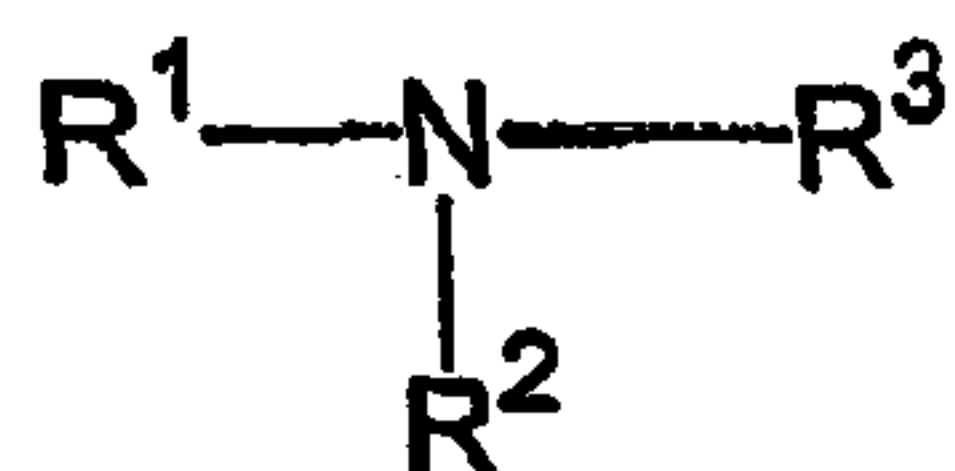

(51)

wherein R^1 is hydrocarbyl or substituted hydrocarbyl having from about 4 to about 30 carbon atoms or $-R^4OR^5$, R^2 is hydrogen or hydrocarbyl or substituted hydrocarbyl having from 1 to about 30 carbon atoms, R^3 is hydroxyalkyl, polyhydroxyalkyl, or poly(hydroxyalkyl)alkyl, R^4 is hydrocarbylene or substituted hydrocarbylene having from 2 to about 18 carbon atoms, and R^5 is hydrogen or hydrocarbyl or substituted hydrocarbyl having from about 1 to about 30 carbon atoms. Preferably, the poly(hydroxyalkyl)amines have the formula:

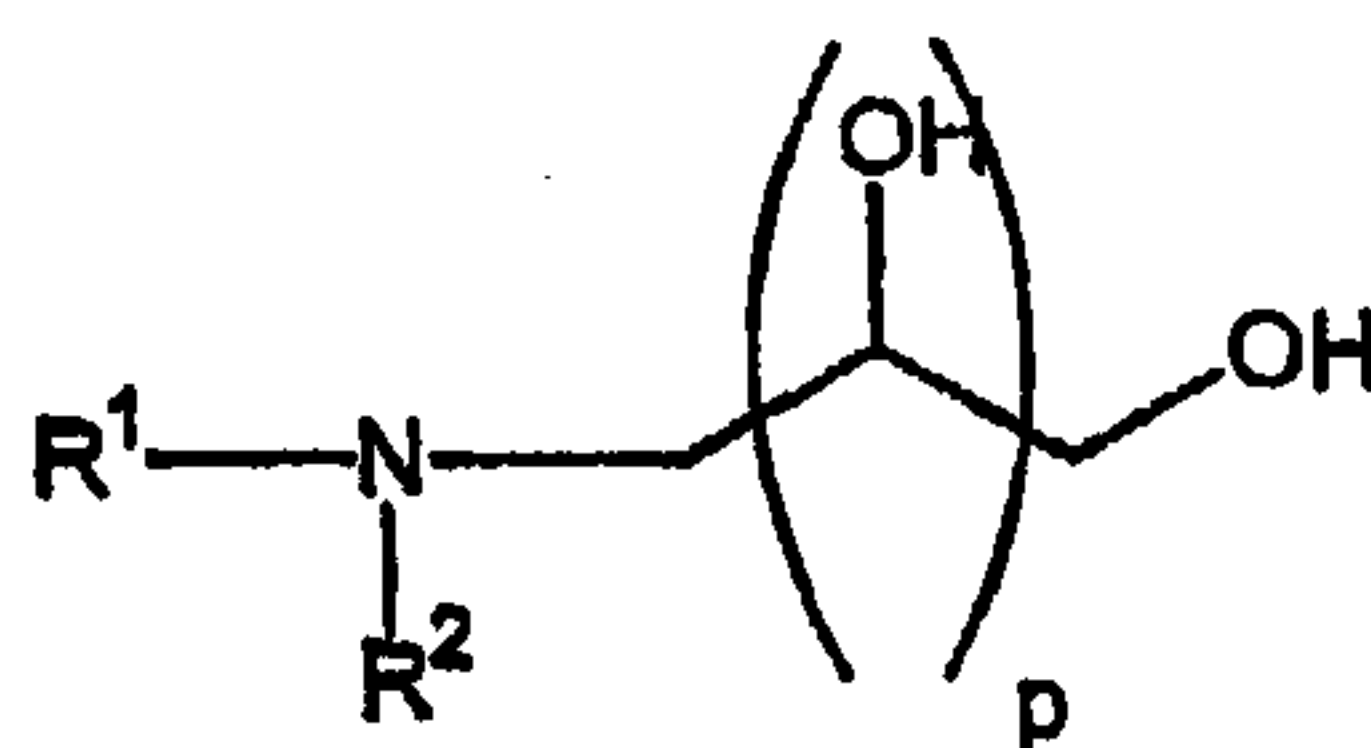

(52)

or

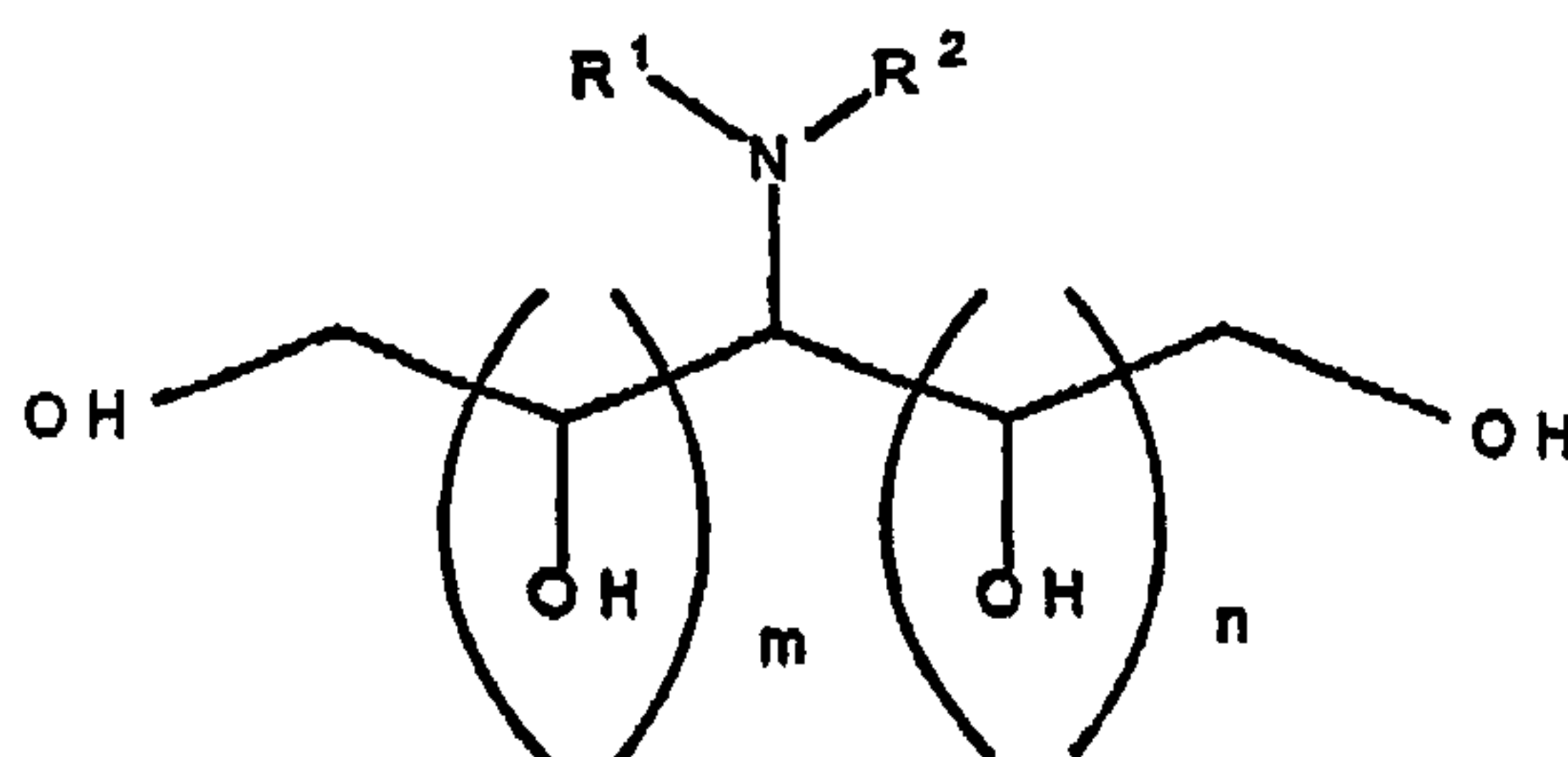

(53)

wherein R^1 is hydrocarbyl or substituted hydrocarbyl having from about 4 to about 30 carbon atoms or $-R^3OR^4$; R^2 is hydrogen or hydrocarbyl or substituted hydrocarbyl having from 1 to about 30 carbon atoms, R^3 is hydrocarbylene or substituted hydrocarbylene having from 2 to about 18 carbon atoms, R^4 is

64725-903 (D)

46

hydrogen or hydrocarbyl or substituted hydrocarbyl having from about 1 to about 30 carbon atoms, m and n are independently integers from 0 to about 7, the sum of m and n is not greater than about 7, and p is an integer from 1 to about 8. In this context, preferred R¹, R², R³, and R⁴ hydrocarbyl (hydrocarbylene) groups are linear or branched alkyl (alkylene), linear or branched alkenyl (alkenylene), linear or branched alkynyl (alkynylene), aryl (arylene), or aralkyl (aralkylene) groups. Preferably, R¹ is a linear or branched alkyl or linear or branched alkenyl group having from about 8 to about 30 carbon atoms or -R³OR⁴, R² is hydrogen, a linear or branched alkyl or linear or branched alkenyl group having from 1 to about 30 carbon atoms, R³ is a linear or branched alkylene or alkenylene group having from 2 to about 6 carbon atoms, R⁴ is a linear or branched alkyl or alkenyl group having from about 8 to about 22 carbon atoms, m and n are independently integers from 0 to about 7, the sum of m and n is from about 3 to 7, and p is an integer from about 4 to about 8; or R¹ and R² are independently linear or branched alkyl or linear or branched alkenyl groups having from about 4 to about 30 carbon atoms, m and n are independently integers from 0 to about 7, the sum of m and n is from about 3 to 7, and p is an integer from about 4 to about 8. More preferably, R¹ is a linear or branched alkyl or linear or branched alkenyl group having from about 8 to about 22 carbon atoms or -R³OR⁴, R² is hydrogen or a linear or branched alkyl or linear or branched alkenyl group having from 1 to about 6 carbon atoms, R³ is a linear or branched alkylene or alkenylene group having from 2 to about 6 carbon atoms, R⁴ is a linear or branched alkyl or alkenyl group having from about 8 to about 18 carbon atoms, m and n are independently integers from 0 to about 7, the sum of m and n is from about 3 to 7, and p is an integer from about 4 to about 8; or R¹ and R² are independently linear or branched alkyl or linear or branched alkenyl groups having from about 4 to about 8 carbon atoms, m and n are independently integers from 0 to about 7, the sum of m and n is from about 3 to 7, and p is an integer from about 4 to about 8. Even more preferably, R¹ is a linear or branched alkyl group having from about 8 to about 18 carbon atoms or -R³OR⁴, R² is hydrogen or methyl, m and n are independently integers from 0 to about 4, R³ is a linear or branched alkylene group having from 2 to about 6 carbon atoms, R⁴ is a linear or branched alkyl group having from about 8 to about 18 carbon atoms, the sum of m and n is about 4, and p is an integer of about 4. Most preferably, R¹ is a linear or branched alkyl group having from about 8 to about 18 carbon atoms or -R³OR⁴, R² is methyl, R³ is ethylene, propylene, hydroxyethylene or 2-hydroxypropylene, R⁴ is a linear or

64725-903 (D)

47

branched alkyl group having from about 8 to about 18 carbon atoms, m and n are independently integers from 0 to about 4, the sum of m and n is about 4, and p is an integer of about 4. Such compounds are commercially available from Aldrich and Clariant.

(f) di-poly(hydroxyalkyl)amine having the formula:

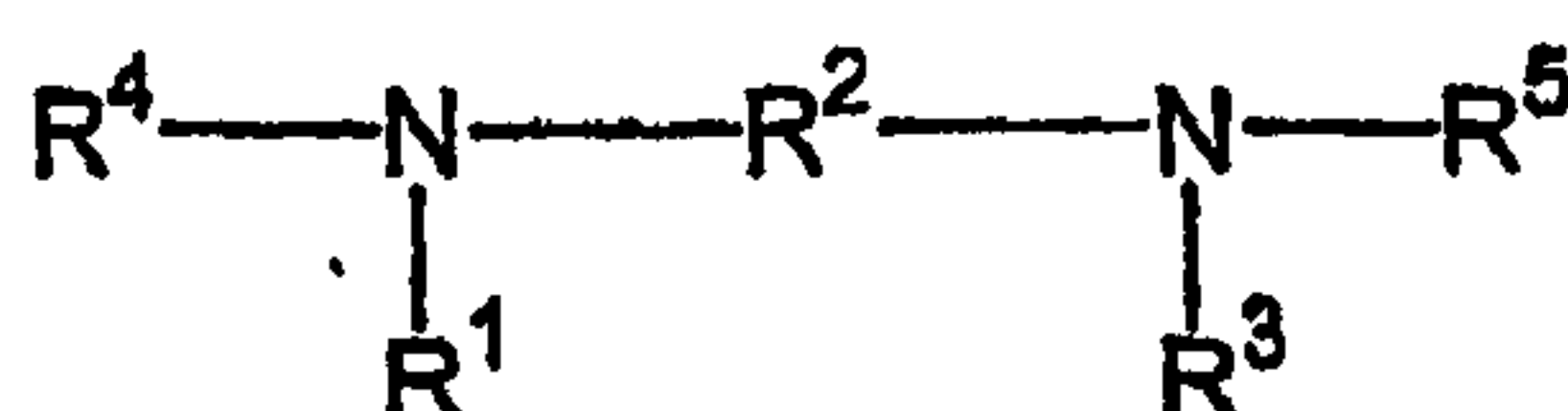

(54)

wherein R^1 and R^3 are independently hydrogen or hydrocarbyl or substituted hydrocarbyl having from 1 to about 22 carbon atoms, R^2 is hydrocarbylene or substituted hydrocarbylene having from 2 to about 18 carbon atoms, and R^4 and R^5 are independently hydroxyalkyl, polyhydroxyalkyl, or poly(hydroxyalkyl)alkyl. In this context, preferred R^1 , R^2 , and R^3 hydrocarbyl (hydrocarbylene) groups are linear or branched alkyl (alkylene), linear or branched alkenyl (alkenylene), linear or branched alkynyl (alkynylene), aryl (arylene), or aralkyl (aralkylene) groups. Preferably, the di-poly(hydroxyalkyl)amine has the formula:

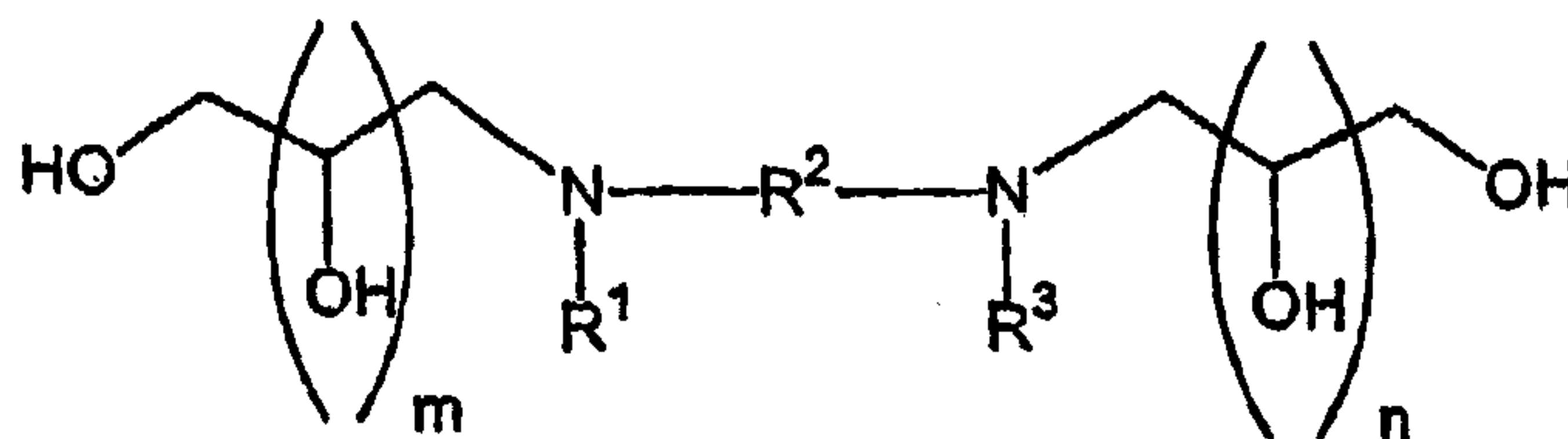

(55)

wherein R^1 and R^3 are independently hydrogen or hydrocarbyl or substituted hydrocarbyl having from 1 to about 22 carbon atoms, R^2 is hydrocarbylene or substituted hydrocarbylene having from 2 to about 18 carbon atoms, and m and n are independently integers from 1 to about 8. In this context, preferred R^1 , R^2 , and R^3 hydrocarbyl (hydrocarbylene) groups are linear or branched alkyl (alkylene), linear or branched alkenyl (alkenylene), linear or branched alkynyl (alkynylene), aryl (arylene), or aralkyl (aralkylene) groups. Preferably, R^1 and R^3 are independently hydrogen or a linear or branched alkyl group having from 1 to about 18 carbon atoms, R^2 is a linear or branched alkylene or linear or branched

64725-903 (D)

48

alkenylene group having from 2 to about 18 carbon atoms, and m and n are independently integers from 1 to about 8. More preferably, R¹ and R³ are independently hydrogen or a linear or branched alkyl group having from 6 to about 12 carbon atoms, R² is a linear or branched alkylene group having from 2 to about 6 carbon atoms, and m and n are independently integers from about 4 to about 8; or R¹ and R³ are independently hydrogen or a linear or branched alkyl group having from 1 to about 4 carbon atoms, R² is a linear or branched alkylene group having from 2 to about 16 carbon atoms, and m and n are independently integers from about 4 to about 8. Most preferably, R¹ and R³ are independently hydrogen or a linear or branched alkyl group having from 6 to about 12 carbon atoms, R² is ethylene or propylene, and m and n are independently integers from about 4 to about 8; or R¹ and R³ are independently hydrogen or a linear or branched alkyl group having from 1 to about 4 carbon atoms, R² is a linear or branched alkylene group having from 2 to about 12 carbon atoms, and m and n are independently integers from about 4 to about 8.

(g) quaternary poly(hydroxyalkyl)amine salts having the formula:

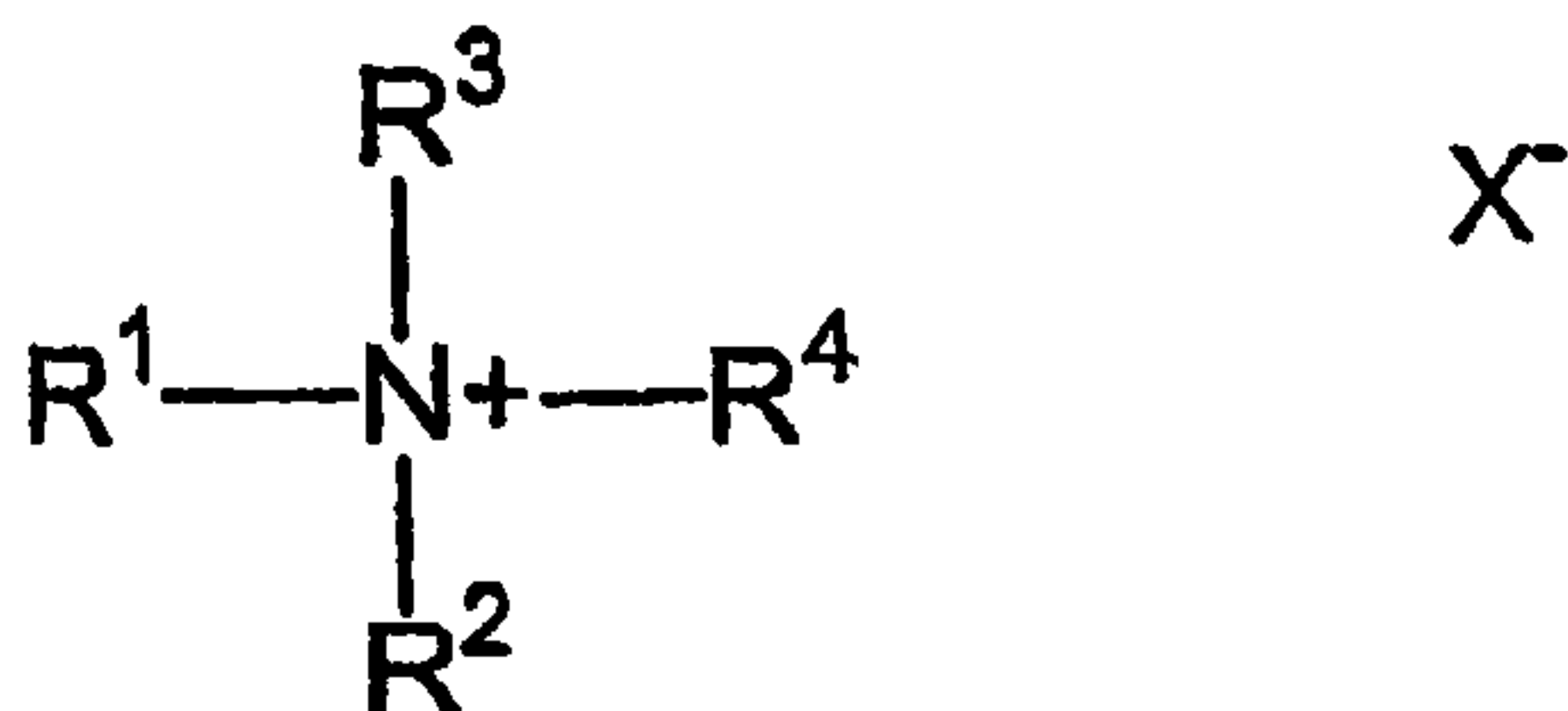

(56)

wherein R¹ is hydrocarbyl or substituted hydrocarbyl having from about 4 to about 30 carbon atoms, R² and R³ are independently hydrogen or hydrocarbyl or substituted hydrocarbyl having from 1 to about 30 carbon atoms, and R⁴ is hydroxyalkyl, polyhydroxyalkyl, or poly(hydroxyalkyl)alkyl. In this context, preferred R¹, R², and R³ hydrocarbyl groups are linear or branched alkyl, linear or branched alkenyl, linear or branched alkynyl, aryl, or aralkyl groups. Preferably, the quaternary poly(hydroxyalkyl)amine salts have the formula:

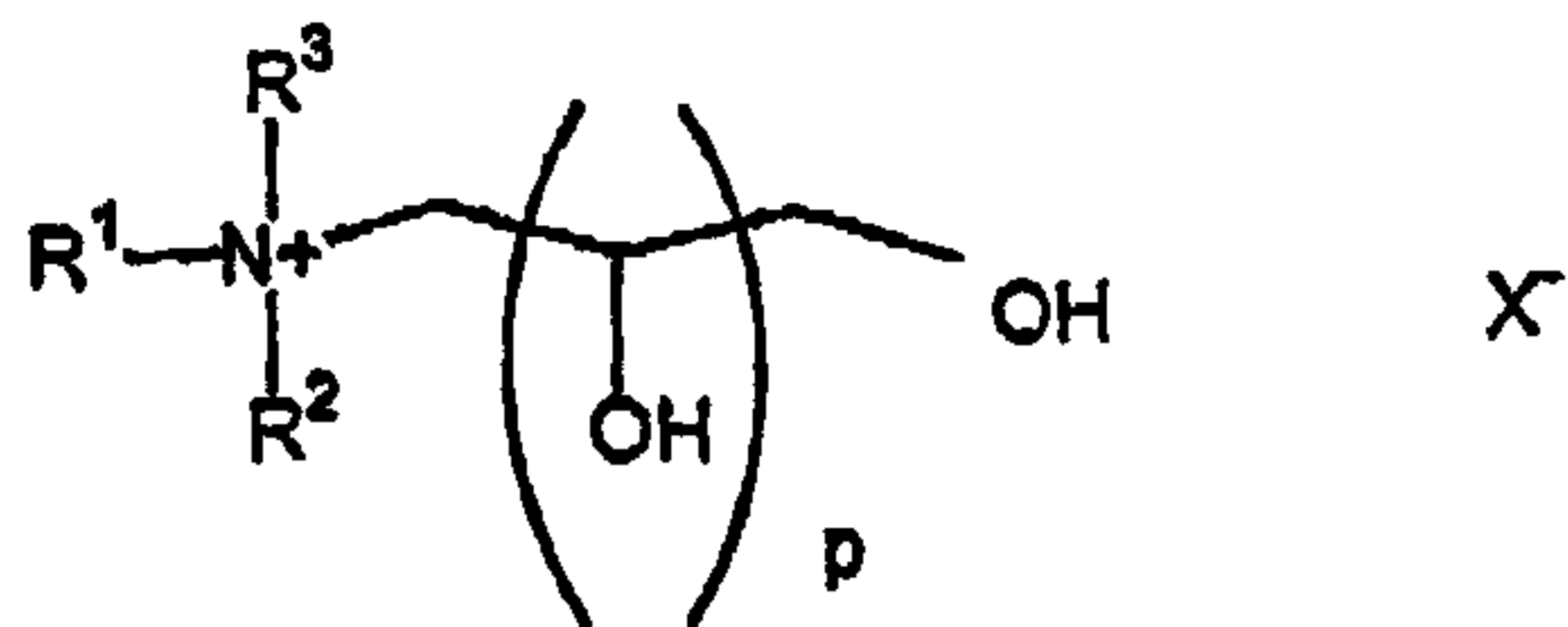

(57)

64725-903 (D)

49

c

or

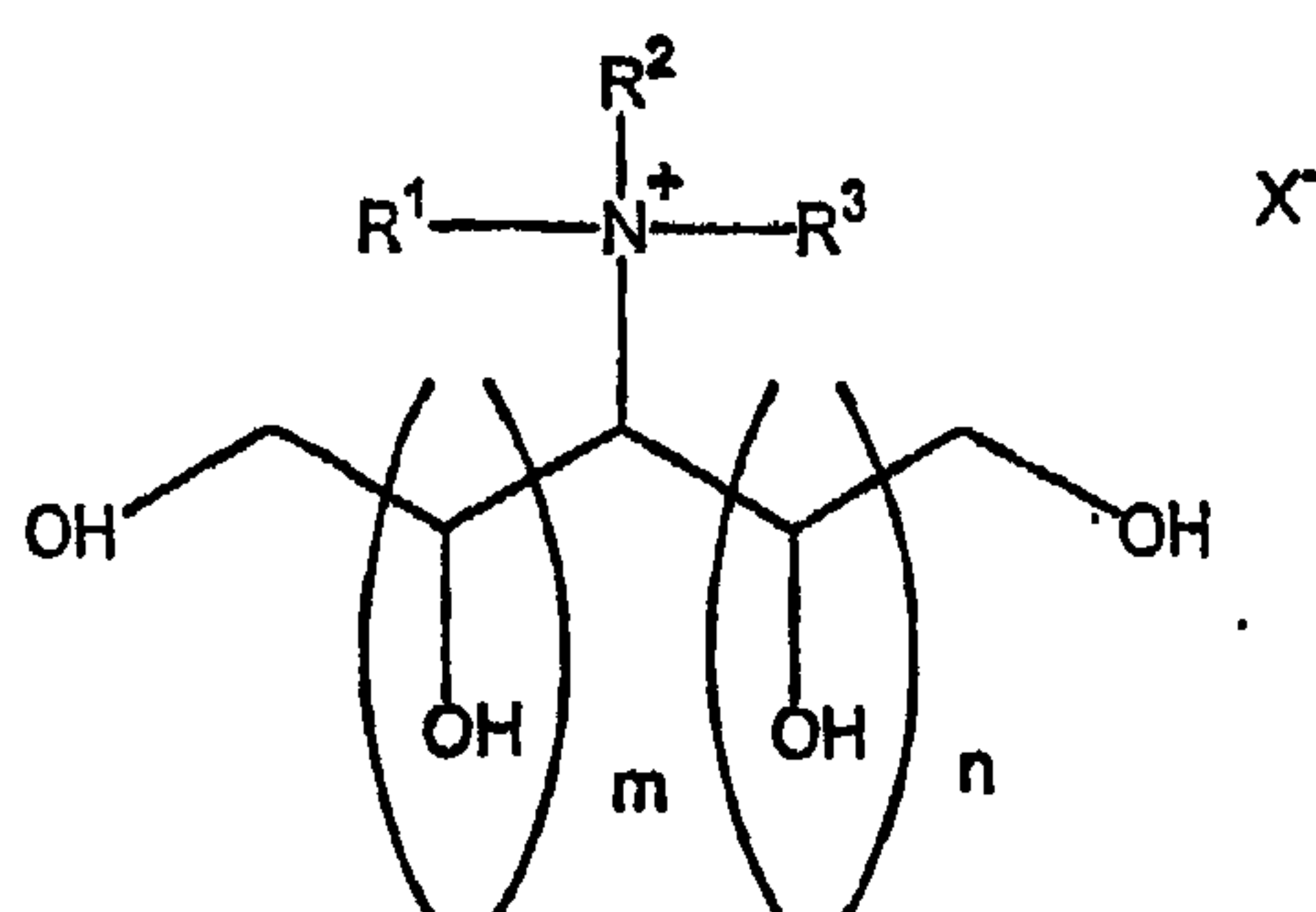

(58)

wherein R¹ is hydrocarbyl or substituted hydrocarbyl having from about 4 to about 30 carbon atoms, R² and R³ are independently hydrogen or hydrocarbyl or substituted hydrocarbyl having from 1 to about 30 carbon atoms, m and n are independently integers from 0 to about 7, the sum of m and n is not greater than about 7, and p is an integer from 1 to about 8. In this context, preferred R¹, R², and R³ hydrocarbyl groups are linear or branched alkyl, linear or branched alkenyl, linear or branched alkynyl, aryl, or aralkyl groups. Preferably, R¹ is a linear or branched alkyl or linear or branched alkenyl group having from about 8 to about 30 carbon atoms, R² and R³ are independently hydrogen or a linear or branched alkyl or linear or branched alkenyl group having from 1 to about 30 carbon atoms, m and n are independently integers from 0 to about 7, the sum of m and n is from about 3 to 7, and p is an integer from about 4 to about 8; or R¹, R² and R³ are independently linear or branched alkyl or linear or branched alkenyl groups having from about 4 to about 30 carbon atoms, m and n are independently integers from 0 to about 7, the sum of m and n is not greater than about 7, and p is an integer from about 4 to about 8. More preferably, R¹ is a linear or branched alkyl or linear or branched alkenyl group having from about 8 to about 22 carbon atoms, R² and R³ are independently hydrogen or a linear or branched alkyl or linear or branched alkenyl group having from 1 to about 6 carbon atoms, m and n are independently integers from 0 to about 7, the sum of m and n is from about 3 to 7, and p is an integer from about 4 to about 8; or R¹, R² and R³ are independently linear or branched alkyl or linear or branched alkenyl groups having from about 4 to about 8 carbon atoms, m and n are independently integers from 0 to about 7, the sum of m and n is from about 3 to 7, and p is an integer from about 4 to about 8. Even more preferably, R¹ is a linear or branched alkyl group

64725-903 (D)

50

having from about 8 to about 18 carbon atoms, R^2 and R^3 are independently hydrogen or methyl, m and n are independently integers from 0 to about 4, the sum of m and n is about 4, and p is an integer of about 4. Most preferably, R^1 is a linear or branched alkyl group having from about 8 to about 18 carbon atoms, R^2 and R^3 are methyl, m and n are independently integers from 0 to about 4, the sum of m and n is about 4, and p is an integer of about 4.

(h) triamines having the formula:

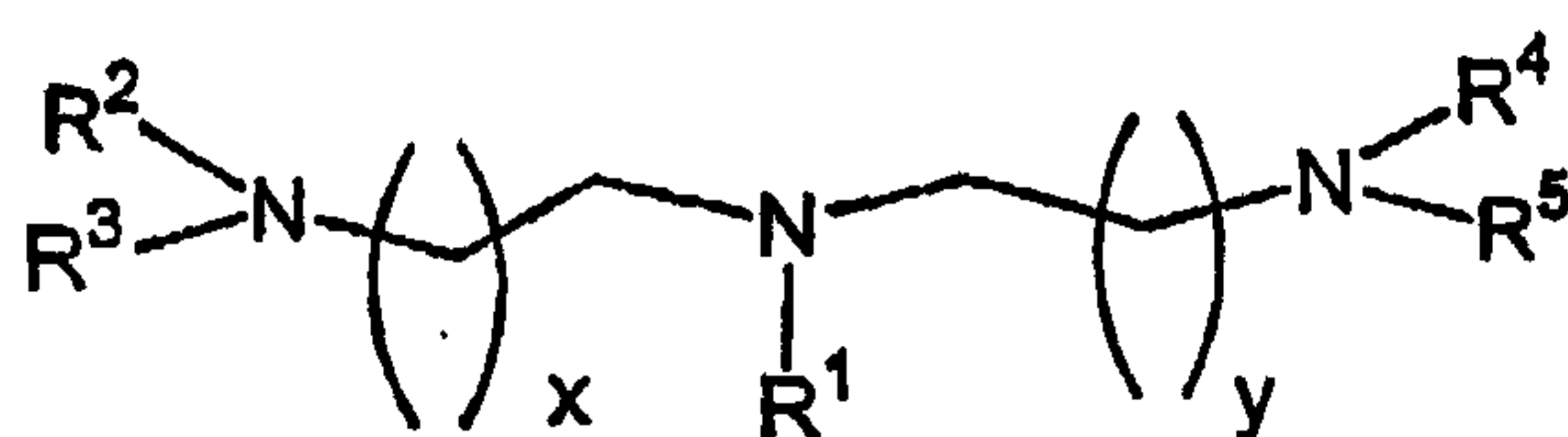

(59)

wherein R^1 is hydrocarbyl or substituted hydrocarbyl having from 1 to about 30 carbon atoms; R^2 , R^3 , R^4 and R^5 are independently hydrogen, hydrocarbyl or substituted hydrocarbyl having from 1 to about 30 carbon atoms, or $-(R^6)_s$, $(R^7O)_nR^6$; R^6 is hydrogen or a linear or branched alkyl group having from 1 to about 4 carbon atoms, R^7 in each of the n (R^7O) groups is independently C_2 - C_4 alkylene; R^8 is hydrocarbylene or substituted hydrocarbylene having from 1 to about 6 carbon atoms, n is an average number from 1 to about 10, s is 0 or 1, and x and y are independently an integer from 1 to about 4. In this context, preferred R^1 , R^2 , R^3 , R^4 , R^5 , and R^8 hydrocarbyl (hydrocarbylene) groups are linear or branched alkyl (alkylene), linear or branched alkenyl (alkenylene), linear or branched alkynyl (alkynylene), aryl (arylene), or aralkyl (aralkylene) groups. Preferably, R^1 is a linear or branched alkyl or linear or branched alkenyl groups having from about 8 to about 30 carbon atoms, R^2 , R^3 , R^4 and R^5 are independently hydrogen, a linear or branched alkyl or linear or branched alkenyl group having from 1 to about 30 carbon atoms, or $-(R^7-O)_nR^6$, R^6 is hydrogen, methyl or ethyl; R^7 in each of the n (R^7O) groups is independently C_2 - C_4 alkylene, n is an average number from 1 to about 10, and x and y are independently an integer from 1 to about 4. More preferably, R^1 is a linear or branched alkyl group having from about 8 to about 18 carbon atoms, R^2 , R^3 , R^4 and R^5 are independently hydrogen, a linear or branched alkyl group having from 1 to about 6 carbon atoms, or $-(R^7-O)_nR^6$, R^6 is hydrogen or methyl, R^7 in each of the n (R^7O) groups is independently ethylene or propylene, n is an average number from 1 to

64725-903 (D)

51

about 5, and x and y are independently an integer from 1 to about 4. Most preferably, R¹ is a linear or branched alkyl group having from about 8 to about 18 carbon atoms, R², R³, R⁴ and R⁵ are independently hydrogen, or -(R⁷-O)_nR⁶, R⁶ is hydrogen, R⁷ in each of the n (R⁷O) groups is independently ethylene or propylene, n is an average number from 1 to about 5, and x and y are independently an integer from 1 to about 4. Commercially available triamines include Acros and Clariant Genamin 3119.

Another cationic surfactant effective in any glyphosate formulations is:

(i) diamines having the formula:

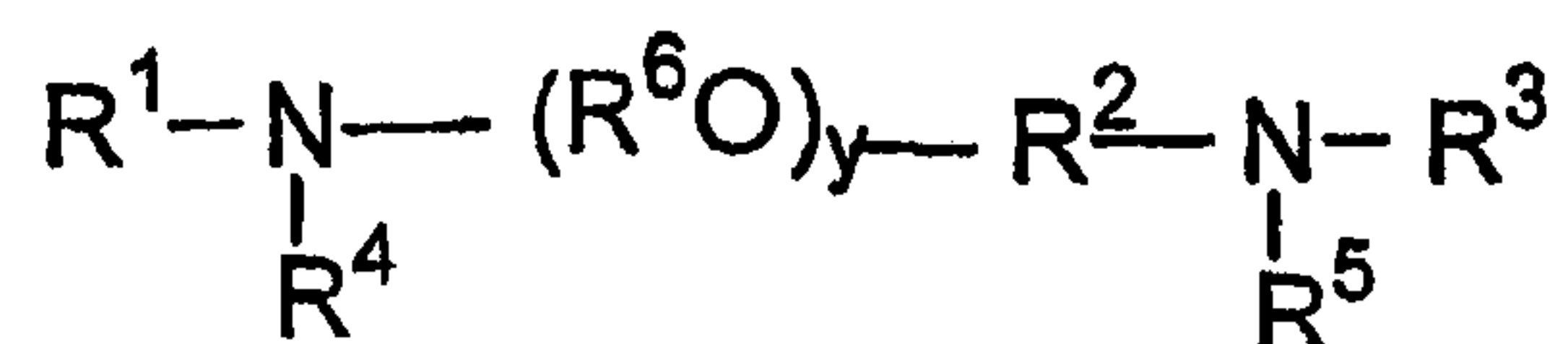

(60)

wherein R¹, R³, R⁴ and R⁵ are independently hydrogen, hydrocarbyl or substituted hydrocarbyl having from 1 to about 30 carbon atoms, or -(R⁶O)_xR⁷, R² is hydrocarbylene or substituted hydrocarbylene having from 2 to about 30 carbon atoms, R⁶ in each of the x (R⁶O) and y (R⁶O) groups is independently C₂-C₄ alkylene, R⁷ is hydrogen, or a linear or branched alkyl group having from 1 to about 30 carbon atoms, x is an average number from 1 to about 30, and y is an average number from about 3 to about 60, provided, however, that when R² is ethylene, either y is greater than 4, R³, R⁴ and R⁵ are independently hydrogen, a linear or branched alkyl, linear or branched alkenyl, linear or branched alkynyl, aryl, or aralkyl group having from 1 to about 30 carbon atoms or -(R⁶O)_xR⁷, R⁶ is other than ethylene, or not more than one of R¹, R³, R⁴ and R⁵ is alkyl or -(R⁶O)_xR⁷. In this context, preferred R¹, R², R³, R⁴, and R⁵ hydrocarbyl (hydrocarbylene) groups are linear or branched alkyl (alkylene), linear or branched alkenyl (alkenylene), linear or branched alkynyl (alkynylene), aryl (arylene), or aralkyl (aralkylene) groups. Preferably, R¹, R³, R⁴ and R⁵ are independently hydrogen or a linear or branched alkyl or alkenyl group having from about 1 to about 22 carbon atoms or -(R⁶O)_xR⁷, R² is a linear or branched alkylene or alkenylene group having from about 1 to about 6 carbon atoms, R⁶ in each of the x(R⁶O) and y (R⁶O) groups is independently C₂-C₄ alkylene, R⁷ is hydrogen, or a linear or branched alkyl group having from 1 to about 4 carbon atoms, x is an average number from 1 to about 30, and y is an average number

64725-903 (D)

52

from 1 to about 60. More preferably, R^1 , R^3 , R^4 and R^5 are independently hydrogen or a linear or branched alkyl group having from about 1 to about 18 carbon atoms or $-(R^6O)_xR^7$, R^2 is a linear or branched alkylene group having from about 1 to about 6 carbon atoms, R^6 in each of the x (R^6O) and y (R^6O) groups is independently ethylene or propylene, R^7 is hydrogen, or a linear or branched alkyl group having from 1 to about 4 carbon atoms, x is an average number from 1 to about 10, and y is an average number from 1 to about 60. Most preferably, R^1 and R^3 are independently linear or branched alkyl groups having from about 8 to about 18 carbon atoms and R^4 and R^5 are independently hydrogen, R^2 is a linear or branched alkylene group having from about 1 to about 6 carbon atoms, R^6 in each of the x (R^6O) and y (R^6O) groups is independently ethylene or propylene, R^7 is hydrogen, or a linear or branched alkyl group having from 1 to about 4 carbon atoms, x is an average number from 1 to about 10, and y is an average number from 10 to about 50.

(j) mono- or di-quaternary ammonium salts having the formula:

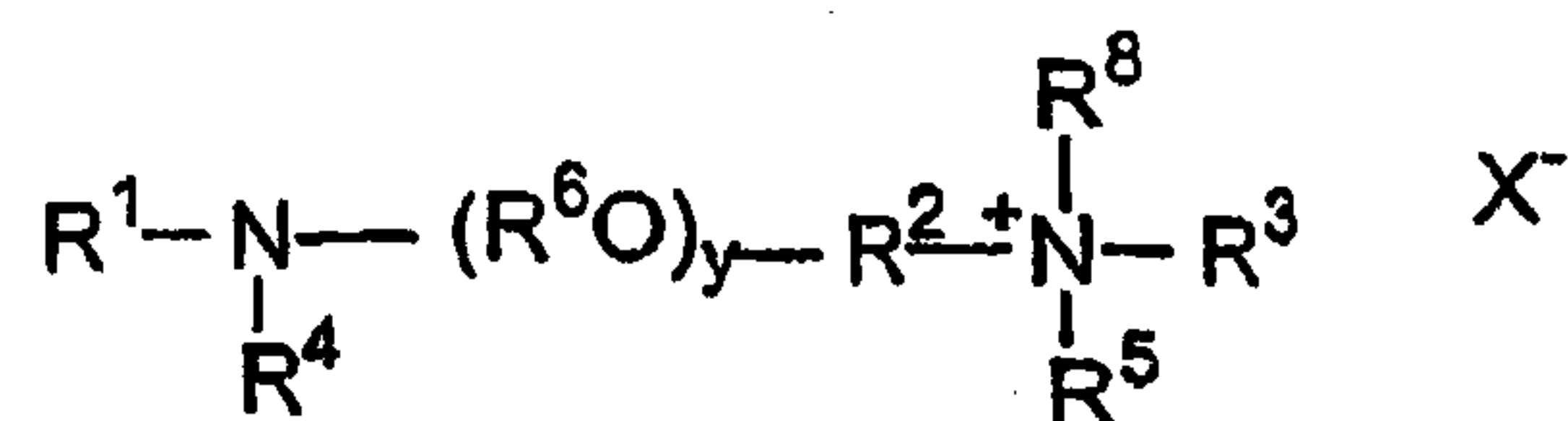

(61)

or

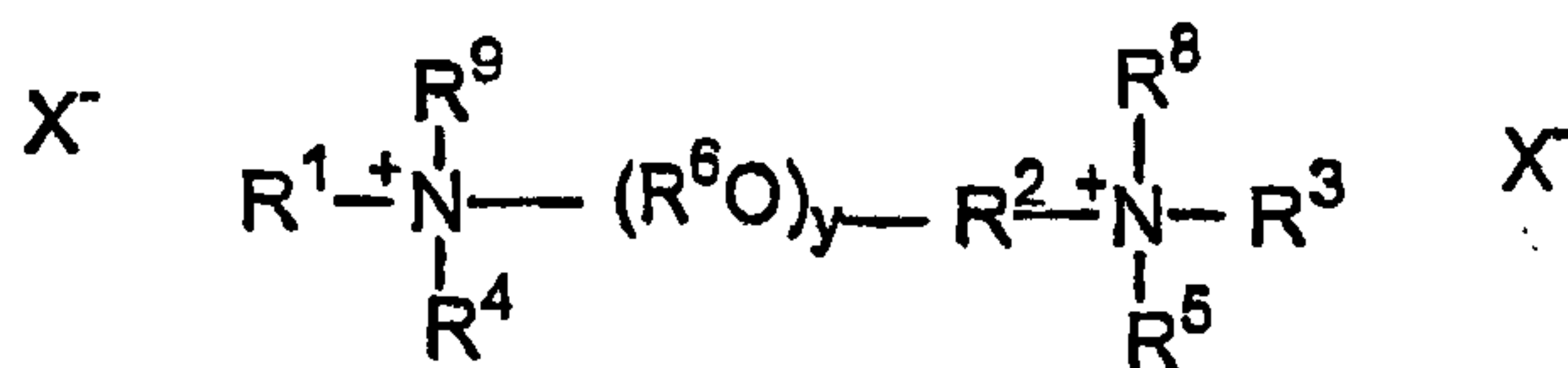

(62)

wherein R^1 , R^3 , R^4 , R^5 , R^8 and R^9 are independently hydrogen, hydrocarbyl or substituted hydrocarbyl having from 1 to about 30 carbon atoms, or $-(R^6O)_xR^7$, R^2 is hydrocarbylene or substituted hydrocarbylene having from 2 to about 30 carbon atoms, R^6 in each of the x (R^6O) and y (R^6O) groups is independently C_2 - C_4 alkylene, R^7 is hydrogen, or a linear or branched alkyl group having from 1 to about 4 carbon atoms, x is an average number from 1 to about 30, y is an average number from about 3 to about 60, and X^- is an agriculturally acceptable

64725-903 (D)

53

anion. In this context, preferred R^1 , R^2 , R^3 , R^4 , R^5 , R^6 and R^9 hydrocarbyl (hydrocarbylene) groups are linear or branched alkyl (alkylene), linear or branched alkenyl (alkenylene), linear or branched alkynyl (alkynylene), aryl (arylene), or aralkyl (aralkylene) groups. Preferably, R^1 , R^3 , R^4 , R^5 , R^8 and R^9 are independently hydrogen or a linear or branched alkyl or alkenyl group having from about 1 to about 22 carbon atoms or $-(R^6O)_xR^7$, R^2 is a linear or branched alkylene or alkenylene group having from about 1 to about 6 carbon atoms, R^6 in each of the $x(R^6O)$ and $y(R^6O)$ groups is independently C_2 - C_4 alkylene, R^7 is hydrogen, or a linear or branched alkyl group having from 1 to about 4 carbon atoms, x is an average number from 1 to about 30, and y is an average number from 1 to about 60. More preferably, R^1 , R^3 , R^4 , R^5 , R^8 and R^9 are independently hydrogen or a linear or branched alkyl group having from about 1 to about 18 carbon atoms or $-(R^6O)_xR^7$, R^2 is a linear or branched alkylene group having from about 1 to about 6 carbon atoms, R^6 in each of the $x(R^6O)$ and $y(R^6O)$ groups is independently ethylene or propylene, R^7 is hydrogen, or a linear or branched alkyl group having from 1 to about 4 carbon atoms, x is an average number from 1 to about 10, and y is an average number from 1 to about 60. Most preferably, R^1 and R^3 are independently linear or branched alkyl groups having from about 8 to about 18 carbon atoms and R^4 , R^5 , R^8 and R^9 are independently hydrogen or methyl, R^2 is a linear or branched alkylene group having from about 1 to about 6 carbon atoms, R^6 in each of the $x(R^6O)$ and $y(R^6O)$ groups is independently ethylene or propylene, R^7 is hydrogen, or a linear or branched alkyl group having from 1 to about 4 carbon atoms, x is an average number from 1 to about 10, and y is an average number from 10 to about 50.

Surfactants effective in formulating potassium, di-ammonium, ammonium, sodium, monoethanolamine, n-propylamine, methylamine, ethylamine, hexamethylenediamine, dimethylamine and/or trimethylsulfonium glyphosate formulations include the nonionic, cationic, anionic and amphoteric surfactants as described below and mixtures thereof.

Cationic surfactants effective in such glyphosate formulations include:

(a) a secondary or tertiary amine having the formula:

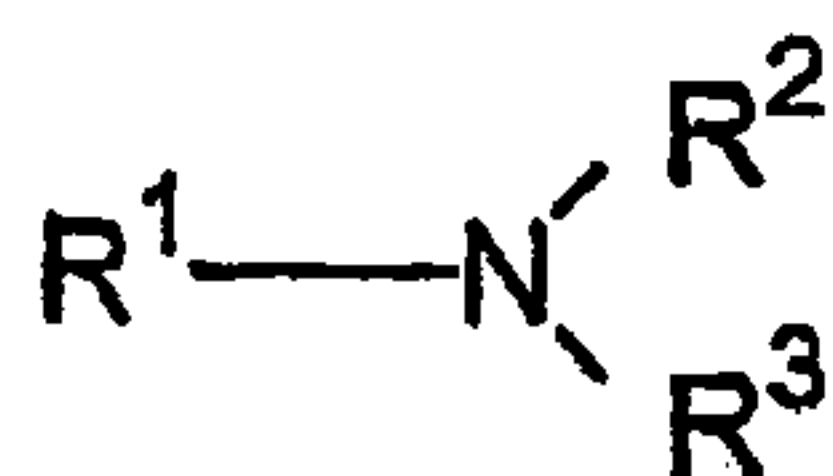

(63)

wherein R^1 and R^2 are hydrocarbyl having from 1 to about 30 carbon atoms, and R^3 is hydrogen or hydrocarbyl having from 1 to about 30 carbon atoms. In this context, preferred R^1 , R^2 , and R^3 hydrocarbyl groups are linear or branched alkyl, linear or branched alkenyl, linear or branched alkynyl, aryl, or aralkyl groups. Preferably, R^1 is a linear or branched alkyl or linear or branched alkenyl group having from about 8 to about 30 carbon atoms, and R^2 and R^3 are independently hydrogen or a linear or branched alkyl or linear or branched alkenyl group having from 1 to about 6 carbon atoms. More preferably, R^1 is a linear or branched alkyl group having from about 12 to about 22 carbon atoms, and R^2 and R^3 are independently hydrogen, methyl or ethyl. In one embodiment of the amine of formula (CC), R^1 is a linear or branched alkyl group having from about 12 to about 22 carbon atoms, and R^2 and R^3 are independently linear or branched hydroxyalkyl groups having from 1 to about 6 carbon atoms.

In one embodiment, the surfactant has the formula (48) wherein R^1 is hydrocarbyl or substituted hydrocarbyl having from about 8 to about 30 carbon atoms, R^2 is a hydroxyalkyl, polyhydroxyalkyl or poly(hydroxyalkyl)alkyl group, and R^3 is hydrogen, hydroxyalkyl, polyhydroxyalkyl or poly(hydroxyalkyl)alkyl. In this context, preferred R^1 hydrocarbyl groups are linear or branched alkyl, linear or branched alkenyl, linear or branched alkynyl, aryl, or aralkyl groups. In one embodiment, R^1 is a linear or branched alkyl, linear or branched alkenyl, linear or branched alkynyl, aryl, or aralkyl group having from about 8 to about 30 carbon atoms, R^2 is a linear or branched hydroxyalkyl group having from 1 to about 6 carbon atoms, and R^3 is hydrogen or a linear or branched hydroxyalkyl group having from 1 to about 6 carbon atoms. Preferably, R^1 is a linear or branched alkyl, linear or branched alkenyl, linear or branched alkynyl, aryl, or aralkyl group having from about 8 to about 22 carbon atoms, R^2 is a linear or branched hydroxyalkyl group having from 1 to about 4 carbon atoms, and R^3 is hydrogen or a linear or branched hydroxyalkyl group having from 1 to about 4 carbon atoms. More preferably, R^1 is a linear or branched alkyl, linear or branched alkenyl, linear or branched alkynyl, aryl, or aralkyl group having from about 8 to about 18 carbon atoms, R^2 is hydroxymethyl or hydroxyethyl, and R^3 is hydrogen, hydroxymethyl or hydroxyethyl.

In one embodiment, the secondary or tertiary amines are included in glyphosate concentrates other than IPA glyphosate, such as glyphosate concentrates containing potassium, di-ammonium, ammonium, sodium, monoethanolamine, n-propylamine, methylamine, ethylamine,

64725-903 (D)

55

c

hexamethylenediamine, dimethylamine, or trimethylsulfonium glyphosate and mixtures thereof, which contain at least about 20 wt.% glyphosate a.e., more preferably at least about 25%, 30%, 35%, 40%, 45%, 50% or 55 wt.% a.e., or at least about 270 g a.e. glyphosate per liter, more preferably at least 300, 360, 400, 420, 440, 460, 480, 500, 520 or 540 g a.e./l.

(b) monoalkoxylated amines having the formula:

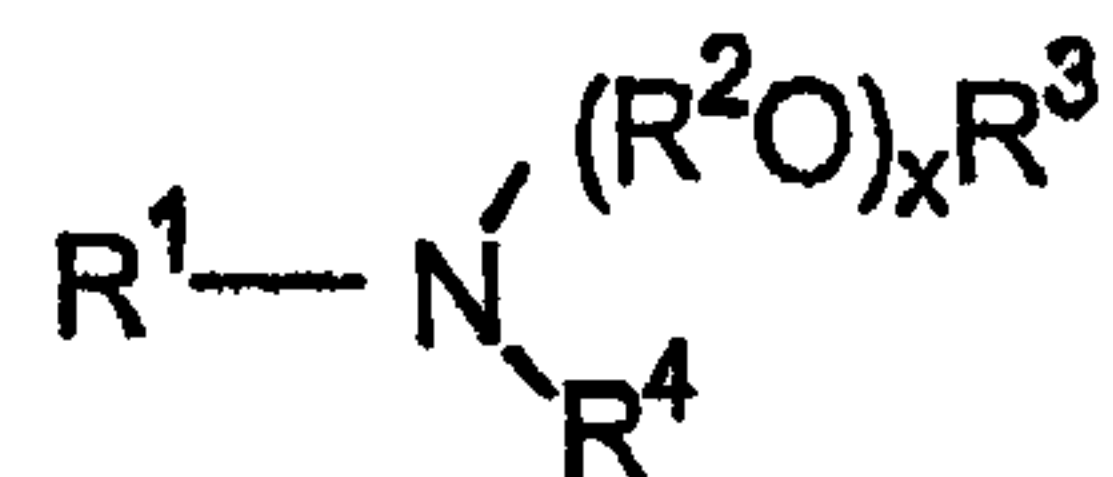

(64)

wherein R^1 and R^4 are independently hydrocarbyl or substituted hydrocarbyl groups having from 1 to about 30 carbon atoms or $-R^5SR^6$, R^2 in each of the x (R^2O) groups is independently C_2-C_4 alkylene, R^3 is hydrogen, or a linear or branched alkyl group having from 1 to about 4 carbon atoms, R^5 is a linear or branched alkyl group having from about 6 to about 30 carbon atoms, R^6 is a hydrocarbyl or substituted hydrocarbyl group having from 4 to about 15 carbon atoms and x is an average number from 1 to about 60. In this context, preferred R^1 , R^4 , and R^6 hydrocarbyl groups are linear or branched alkyl, linear or branched alkenyl, linear or branched alkynyl, aryl, or aralkyl groups. In one embodiment, R^1 includes from about 7 to about 30 carbon atoms, preferably from about 8 to about 22 carbon atoms, and the remaining groups are as described above. Preferably, R^1 and R^4 are independently a linear or branched alkyl or linear or branched alkenyl group having from 1 to about 25 carbon atoms, R^2 in each of the x (R^2O) groups is independently C_2-C_4 alkylene, R^3 is hydrogen, methyl or ethyl, and x is an average number from 1 to about 40. More preferably, R^1 and R^4 are independently a linear or branched alkyl group having from 1 to about 22 carbon atoms, R^2 in each of the x (R^2O) groups is independently ethylene or propylene, R^3 is hydrogen or methyl, and x is an average number from 1 to about 30. Even more preferably, R^1 is a linear or branched alkyl group having from about 8 to about 22 carbon atoms and R^4 is a linear or branched alkyl group having from 1 to about 22 carbon atoms, R^2 in each of the x (R^2O) groups is independently ethylene or propylene, R^3 is hydrogen or methyl, and x is an average number from about 1 to about 10. Most preferably, R^1 is a linear or branched alkyl group having from about 16 to about 22 carbon atoms and R^4 is methyl, R^2 in each of the x (R^2O) groups is ethylene, R^3 is hydrogen, and x is an average number from about 1 to about 5, or R^1 is a linear or branched alkyl group having from about 8

64725-903 (D)

56

to about 15 carbon atoms and R^4 is methyl, R^2 in each of the x (R^2O) groups is ethylene, R^3 is hydrogen, and x is an average number from about 5 to about 10.

In one embodiment, the monoalkoxylated amines are included in glyphosate concentrates other than IPA glyphosate, such as glyphosate concentrates containing potassium, di-ammonium, ammonium, sodium, monoethanolamine, n-propylamine, methylamine, ethylamine, hexamethylenediamine, dimethylamine, or trimethylsulfonium glyphosate and mixtures thereof, which contain at least about 20 wt.% glyphosate a.e., more preferably at least about 25%, 30%, 35%, 40%, 45%, 50% or 55 wt.% a.e., or at least about 270 g a.e. glyphosate per liter, more preferably at least 300, 360, 400, 420, 440, 460, 480, 500, 520 or 540 g a.e./l.

(c) dialkoxylated quaternary ammonium salt having the formula:

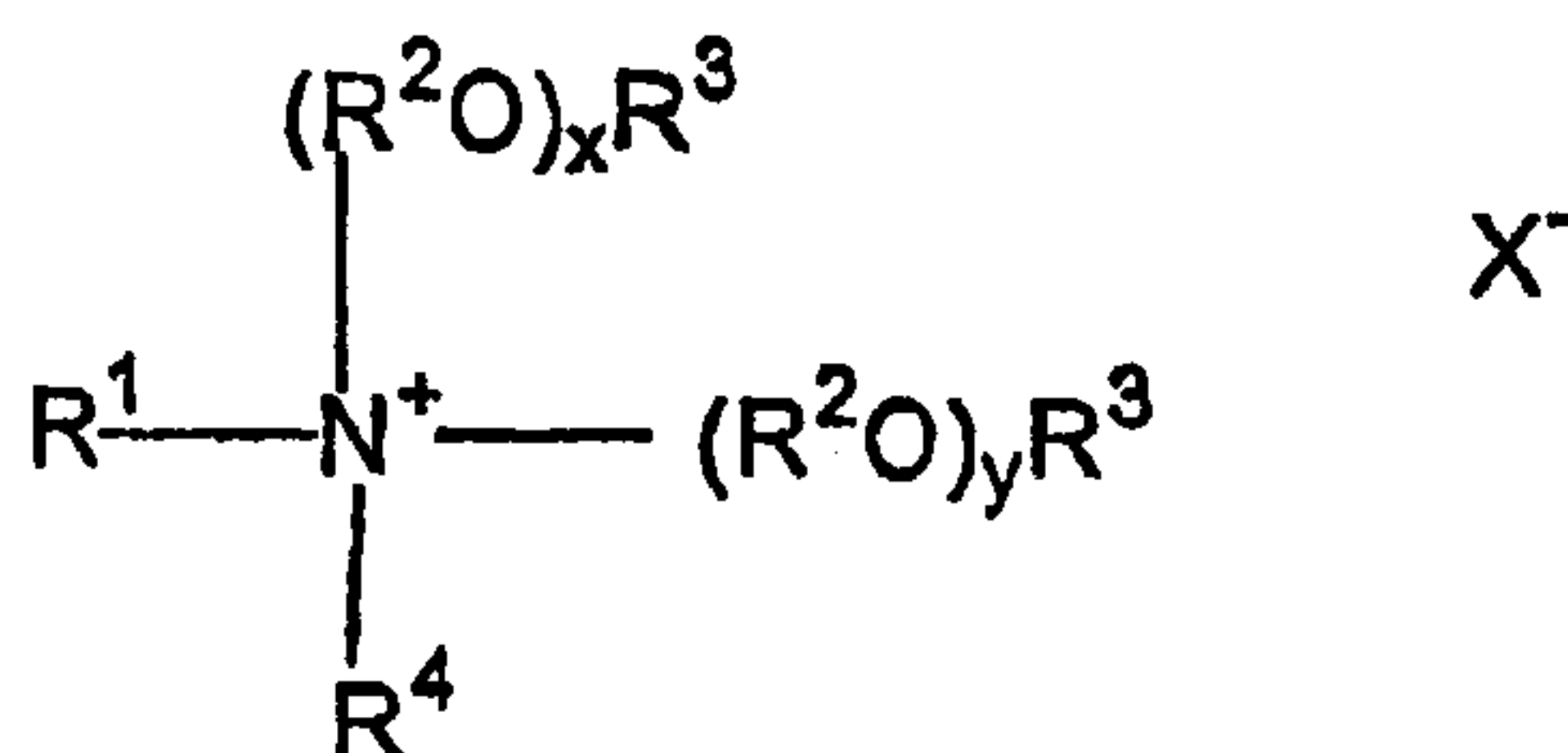

(65)

wherein R^1 is hydrocarbyl or substituted hydrocarbyl having from 1 to about 30 carbon atoms, R^2 in each of the x (R^2O) and y (R^2O) groups is independently C_2 - C_4 alkylene, R^3 is hydrogen, or a linear or branched alkyl group having from 1 to about 4 carbon atoms, R^4 is hydrogen or hydrocarbyl or substituted hydrocarbyl having from 1 to about 30 carbon atoms, x and y are independently an average number from 1 to about 40, and X^- is an agriculturally acceptable anion. In this context, preferred R^1 and R^4 hydrocarbyl groups are linear or branched alkyl, linear or branched alkenyl, linear or branched alkynyl, aryl, or aralkyl groups. Preferably, R^1 and R^4 are independently a linear or branched alkyl or linear or branched alkenyl group having from 1 to about 25 carbon atoms, R^2 in each of the x (R^2O) and y (R^2O) groups is independently C_2 - C_4 alkylene, R^3 is hydrogen, methyl or ethyl, and the sum of x and y is an average number from about 2 to about 30. More preferably, R^1 and R^4 are independently a linear or branched alkyl group having from 1 to about 22 carbon atoms, R^2 in each of the x (R^2O) and y (R^2O) groups is independently ethylene or propylene, R^3 is hydrogen or methyl, and the sum of x and y is an average number from about 2 to about 20. Even more preferably, R^1 is a linear or branched alkyl group having from about 8 to

64725-903 (D)

57

about 22 carbon atoms and R^4 is a linear or branched alkyl group having from 1 to about 22 carbon atoms, R^2 in each of the x (R^2O) and y (R^2O) groups is independently ethylene or propylene, R^3 is hydrogen or methyl, and x is an average number from about 2 to about 20. Most preferably, R^1 is a linear or branched alkyl group having from about 8 to about 22 carbon atoms and R^4 is a linear or branched alkyl group having from 1 to about 6 carbon atoms, R^2 in each of the x (R^2O) and y (R^2O) groups is independently ethylene or propylene, R^3 is hydrogen or methyl, and x is an average number from about 2 to about 15, or R^1 and R^4 are independently a linear or branched alkyl group having from about 8 to about 22 carbon atoms, R^2 in each of the x (R^2O) and y (R^2O) groups is independently ethylene or propylene, R^3 is hydrogen or methyl, and x is an average number from about 5 to about 15. Preferred dialkoxylated quaternary ammonium surfactants include Ethoquad™ C12 (a PEG 2 coco methyl ammonium chloride from Akzo Nobel), PEG 5 coco methyl ammonium chloride, PEG 5 tallow methyl ammonium chloride, PEG 5 ditallow ammonium bromide, and PEG 10 ditallow ammonium bromide.

In one embodiment, the dialkoxylated quaternary ammonium salts are included in glyphosate concentrates other than IPA glyphosate, such as glyphosate concentrates containing potassium, di-ammonium, ammonium, sodium, monoethanolamine, n-propylamine, methylamine, ethylamine, hexamethylenediamine, dimethylamine, or trimethylsulfonium glyphosate and mixtures thereof, which contain at least about 20 wt.% glyphosate a.e., more preferably at least about 25%, 30%, 35%, 40%, 45%, 50% or 55 wt.% a.e., or at least about 270 g a.e. glyphosate per liter, more preferably at least 300, 360, 400, 420, 440, 460, 480, 500, 520 or 540 g a.e./l.

(d) monoalkoxylated quaternary ammonium salts having the formula:

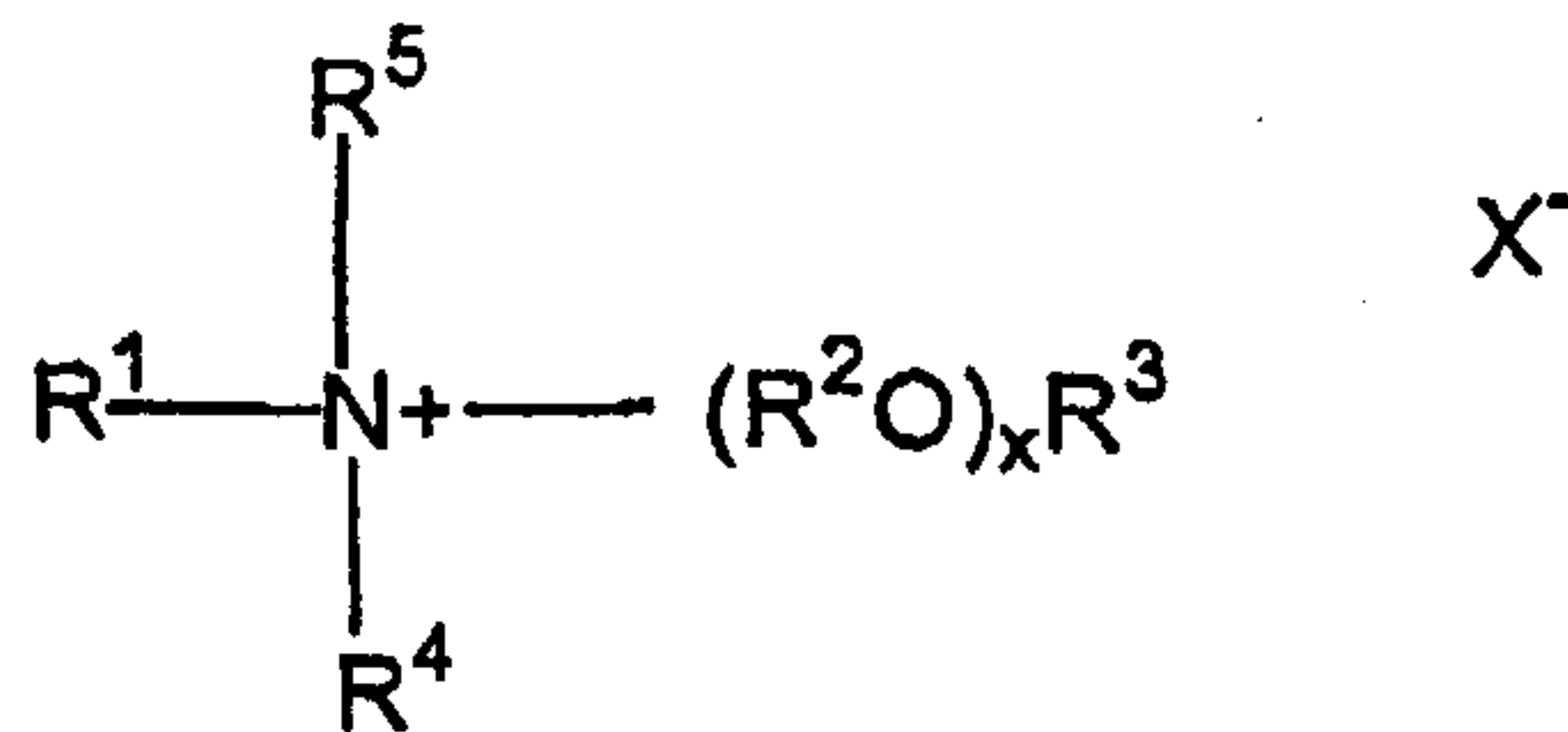

(66)

wherein R^1 and R^5 are independently hydrogen or hydrocarbyl or substituted hydrocarbyl having from 1 to about 30 carbon atoms, R^4 is hydrocarbyl or substituted hydrocarbyl having from 1 to about 30 carbon atoms, R^2 in each of the

64725-903 (D)

58

x (R^2O) groups is independently C_2-C_4 alkylene, R^3 is hydrogen, or a linear or branched alkyl group having from 1 to about 30 carbon atoms, x is an average number from 1 to about 60, and X^- is an agriculturally acceptable anion. In this context, preferred R^1 , R^4 , and R^5 hydrocarbyl groups are linear or branched alkyl, linear or branched alkenyl, linear or branched alkynyl, aryl, or aralkyl groups. Preferably, R^1 , R^4 and R^5 are independently a linear or branched alkyl or linear or branched alkenyl group having from 1 to about 25 carbon atoms, R^2 in each of the x (R^2O) groups is independently C_2-C_4 alkylene, R^3 is hydrogen, methyl or ethyl, and x is an average number from 1 to about 40. More preferably, R^1 , R^4 and R^5 are independently a linear or branched alkyl group having from 1 to about 22 carbon atoms, R^2 in each of the x (R^2O) groups is independently ethylene or propylene, R^3 is hydrogen or methyl, and x is an average number from 1 to about 30. Even more preferably, R^1 is a linear or branched alkyl group having from about 8 to about 22 carbon atoms, R^2 in each of the x (R^2O) groups is independently ethylene or propylene, R^3 is hydrogen or methyl, R^4 and R^5 are independently a linear or branched alkyl group having from 1 to about 22 carbon atoms, and x is an average number from 1 to about 30. Even more preferably, R^1 is a linear or branched alkyl group having from about 8 to about 22 carbon atoms, R^2 in each of the x (R^2O) groups is independently ethylene or propylene, R^3 is hydrogen or methyl, R^4 and R^5 are independently a linear or branched alkyl group having from 1 to about 6 carbon atoms, and x is an average number from about 5 to about 25. Most preferably, R^1 is a linear or branched alkyl group having from about 16 to about 22 carbon atoms, R^2 in each of the x (R^2O) groups is independently ethylene or propylene, R^3 is hydrogen or methyl, R^4 and R^5 are independently a linear or branched alkyl group having from 1 to about 3 carbon atoms, and x is an average number from about 5 to about 25. Preferred monoalkoxylated quaternary ammonium surfactants include PEG 7 C_{18} dimethyl ammonium chloride and PEG 22 C_{18} dimethyl ammonium chloride.

In one embodiment, the monoalkoxylated quaternary ammonium salts are included in glyphosate concentrates other than IPA glyphosate, such as glyphosate concentrates containing potassium, di-ammonium, ammonium, sodium, monoethanolamine, n-propylamine, methylamine, ethylamine, hexamethylenediamine, dimethylamine, or trimethylsulfonium glyphosate and mixtures thereof, which contain at least about 20 wt.% glyphosate a.e., more preferably at least about 25%, 30%, 35%, 40%, 45%, 50% or 55 wt.% a.e., or at

64725-903 (D)

59

least about 270 g a.e. glyphosate per liter, more preferably at least 300, 360, 400, 420, 440, 460, 480, 500, 520 or 540 g a.e./l.

(e) quaternary ammonium salts having the formula:

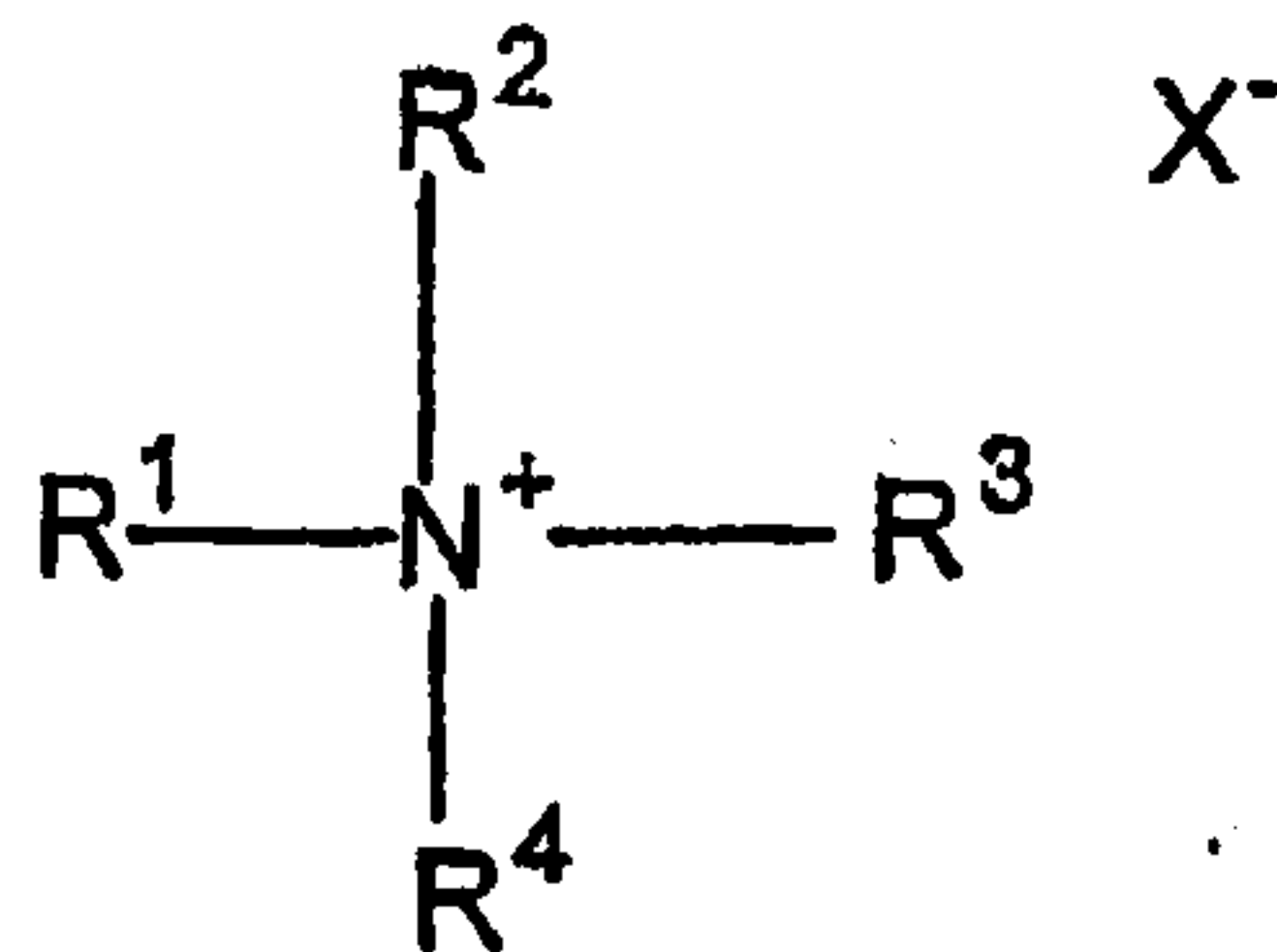

(67)

wherein R^1 , R^3 and R^4 are independently hydrogen or hydrocarbyl or substituted hydrocarbyl having from 1 to about 30 carbon atoms, R^2 is hydrocarbyl or substituted hydrocarbyl having from 1 to about 30 carbon atoms, and X^- is an agriculturally acceptable anion. In this context, preferred R^1 , R^2 , R^3 , and R^4 hydrocarbyl groups are linear or branched alkyl, linear or branched alkenyl, linear or branched alkynyl, aryl, or aralkyl groups. Preferably, R^1 is a linear or branched alkyl or linear or branched alkenyl group having from about 8 to about 30 carbon atoms, and R^2 , R^3 and R^4 are independently a linear or branched alkyl or linear or branched alkenyl group having from 1 to about 30 carbon atoms. More preferably, R^1 is a linear or branched alkyl or linear or branched alkenyl group having from about 8 to about 22 carbon atoms, and R^2 , R^3 and R^4 are independently a linear or branched alkyl or linear or branched alkenyl group having from 1 to about 6 carbon atoms. Even more preferably, R^1 is a linear or branched alkyl group having from about 8 to about 16 carbon atoms, and R^2 , R^3 and R^4 are independently a linear or branched alkyl group having from 1 to about 6 carbon atoms. Most preferably, R^1 is a linear or branched alkyl group having from about 8 to about 14 carbon atoms, and R^2 , R^3 and R^4 are methyl. Preferred commercially available quaternary ammonium surfactants include Arquad™ C-50 (a dodecyl trimethyl ammonium chloride from Akzo Nobel) and Arquad™ T-50 (a tallow trimethyl ammonium chloride from Akzo Nobel).

In one embodiment, the quaternary ammonium salts are included in glyphosate concentrates other than IPA glyphosate, such as glyphosate concentrates containing potassium, di-ammonium, ammonium, sodium, monoethanolamine, n-propylamine, methylamine, ethylamine, hexamethylenediamine, dimethylamine, or trimethylsulfonium glyphosate and mixtures thereof, which contain at least about 20 wt.% glyphosate a.e., more

64725-903 (D)

60

preferably at least about 25%, 30%, 35%, 40%, 45%, 50% or 55 wt.% a.e., or at least about 270 g a.e. glyphosate per liter, more preferably at least 300, 360, 400, 420, 440, 460, 480, 500, 520 or 540 g a.e./l.

(f) ether amines having the formula:

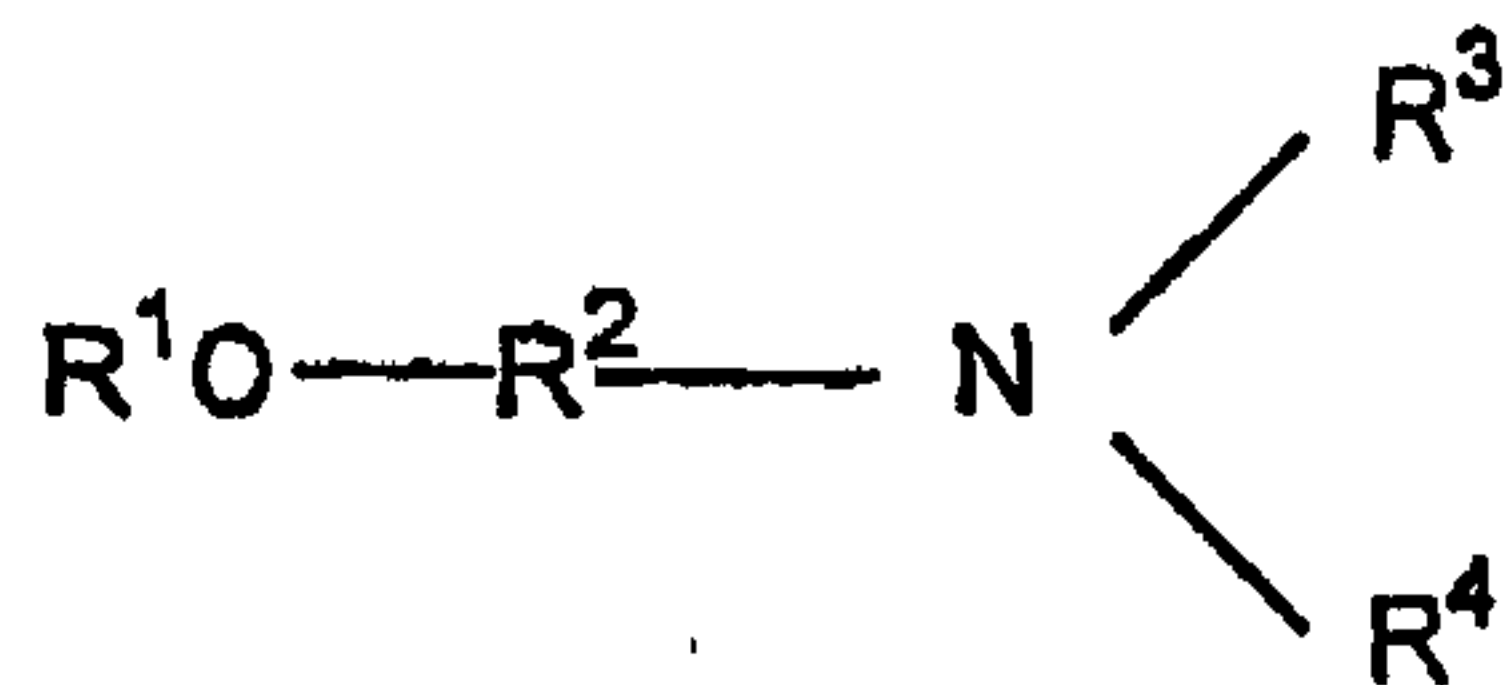

(68)

wherein R^1 is hydrocarbyl or substituted hydrocarbyl having from 1 to about 30 carbon atoms; R^2 is hydrocarbylene or substituted hydrocarbylene having from 2 to about 30 carbon atoms; R^3 and R^4 are independently hydrogen, hydrocarbyl or substituted hydrocarbyl having from 1 to about 30 carbon atoms, or $-(\text{R}^5\text{O})_x\text{R}^6$, R^5 in each of the $x(\text{R}^5\text{O})$ groups is independently $\text{C}_2\text{-C}_4$ alkylene, R^6 is hydrogen, or a linear or branched alkyl group having from 1 to about 4 carbon atoms, and x is an average number from 1 to about 50. In this context, preferred R^1 , R^2 , R^3 , and R^4 hydrocarbyl (hydrocarbylene) groups are linear or branched alkyl (alkylene), linear or branched alkenyl (alkenylene), linear or branched alkynyl (alkynylene), aryl (arylene), or aralkyl (aralkylene) groups. Preferably, R^1 is a linear or branched alkyl, linear or branched alkenyl, linear or branched alkynyl, aryl, or aralkyl group having from 8 to about 25 carbon atoms, R^2 is a linear or branched alkylene or alkenylene group having from 2 to about 30 carbon atoms, R^3 and R^4 are independently hydrogen, a linear or branched alkyl, linear or branched alkenyl, linear or branched alkynyl, aryl, or aralkyl group having from 1 to about 30 carbon atoms, or $-(\text{R}^5\text{O})_x\text{R}^6$, R^5 in each of the $x(\text{R}^5\text{O})$ groups is independently $\text{C}_2\text{-C}_4$ alkylene, R^6 is hydrogen, methyl or ethyl, and x is an average number from 1 to about 30. More preferably, R^1 is a linear or branched alkyl or alkenyl group having from 8 to about 22 carbon atoms, R^2 is a linear or branched alkylene or alkenylene group having from 2 to about 6 carbon atoms, R^3 and R^4 are independently hydrogen, a linear or branched alkyl or alkenyl group having from 1 to about 6 carbon atoms, or $-(\text{R}^5\text{O})_x\text{R}^6$, R^5 in each of the $x(\text{R}^5\text{O})$ groups is independently ethylene or propylene, R^6 is hydrogen or methyl, and x is an average number from 1 to about 15. Most preferably, R^1 is a linear or branched alkyl or alkenyl group having from 8 to about 18 carbon atoms, R^2 is ethylene or propylene, R^3 and R^4 are independently hydrogen, methyl, or $-(\text{R}^5\text{O})_x\text{R}^6$, R^5 in

64725-903 (D)

61

each of the x (R⁶O) groups is independently ethylene or propylene, R⁶ is hydrogen, and x is an average number from 1 to about 5.

In one embodiment, the ether amines are included in glyphosate concentrates other than IPA glyphosate, such as glyphosate concentrates containing potassium, di-ammonium, ammonium, sodium, monoethanolamine, n-propylamine, methylamine, ethylamine, hexamethylenediamine, dimethylamine, or trimethylsulfonium glyphosate and mixtures thereof, which contain at least about 20 wt.% glyphosate a.e., more preferably at least about 25%, 30%, 35%, 40%, 45%, 50% or 55 wt.% a.e., or at least about 270 g a.e. glyphosate per liter, more preferably at least 300, 360, 400, 420, 440, 460, 480, 500, 520 or 540 g a.e./l.

(g) diamines having the formula:

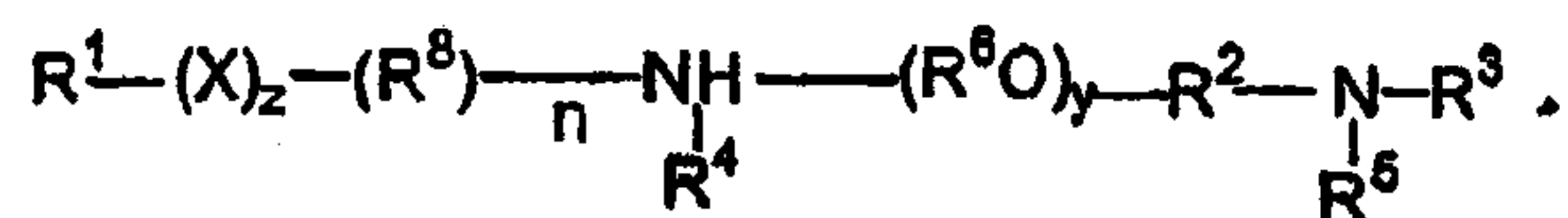

(69)

wherein R¹, R³, R⁴ and R⁵ are independently hydrogen, hydrocarbyl or substituted hydrocarbyl having from 1 to about 30 carbon atoms, or -(R⁶O)_xR⁷; R² and R⁸ are independently hydrocarbylene or substituted hydrocarbylene having from 2 to about 30 carbon atoms, R⁶ in each of the x (R⁶O) and y (R⁶O) groups is independently C₂-C₄ alkylene, R⁷ is hydrogen, or a linear or branched alkyl group having from 1 to about 30 carbon atoms, x is an average number from 1 to about 30, X is -O-, -N(R⁶)-, -C(O)-, -C(O)O-, -OC(O)-, -N(R⁹)C(O)-, -C(O)N(R⁹)-, -S-, -SO-, or -SO₂-, y is 0 or an average number from 1 to about 30, n and z are independently 0 or 1, and R⁹ is hydrogen or hydrocarbyl or substituted hydrocarbyl. In this context, preferred R¹, R², R³, R⁴, R⁵ and R⁹ hydrocarbyl (hydrocarbylene) groups are linear or branched alkyl (alkylene), linear or branched alkenyl (alkenylene), linear or branched alkynyl (alkynylene), aryl (arylene), or aralkyl (aralkylene) groups. Preferably, R¹ and R⁴ are independently a linear or branched alkyl or linear or branched alkenyl group having from about 1 to about 22 carbon atoms, R² and R⁸ are independently linear or branched alkylene groups having from about 2 to about 25 carbon atoms, R³ and R⁵ are each independently hydrogen or a linear or branched alkyl group having from 1 to about 6 carbon atoms and n, y and z are 0; or R¹, R², R³ and R⁴ are independently hydrogen or a linear or branched alkyl or alkenyl group having from about 1 to about 6 carbon

64725-903 (D)

62

atoms, R^2 is a linear or branched alkylene or alkenylene group having from about 8 to about 25 carbon atoms, and n , y and z are 0; or R^1 , R^2 , R^3 and R^4 are independently hydrogen or a linear or branched alkyl or alkenyl group having from about 1 to about 6 carbon atoms, R^2 is a linear or branched alkylene or alkenylene group having from about 1 to about 6 carbon atoms, R^6 in each of the y (R^6O) groups is independently C_2 - C_4 alkylene, y is an average number from 1 to about 20 and n and z are 0; or R^1 and R^3 are independently a linear or branched alkyl or linear or branched alkenyl group having from about 8 to about 22 carbon atoms, R^2 is a linear or branched alkylene group having from about 2 to about 25 carbon atoms; and R^4 and R^5 are each independently hydrogen, a linear or branched alkyl or alkenyl group having from 1 to about 6 carbon atoms, or $-(R^6O)_xR^7$, R^6 in each of the x (R^6O) groups is independently C_2 - C_4 alkylene, R^7 is hydrogen, or a linear or branched alkyl group having from 1 to about 4 carbon atoms, x is an average number from 1 to about 30, and n , y and z are 0; or R^1 is a linear or branched alkyl or linear or branched alkenyl group having from about 1 to about 22 carbon atoms, R^2 is a linear or branched alkylene group having from about 2 to about 25 carbon atoms, R^3 , R^4 and R^5 are each independently hydrogen or a linear or branched alkyl group having from 1 to about 6 carbon atoms, X is $-C(O)-$ or $-SO_2-$, n and y are 0 and z is 1. More preferably, R^1 and R^4 are independently a linear or branched alkyl or linear or branched alkenyl group having from about 4 to about 18 carbon atoms, R^2 is a linear or branched alkylene group having from about 2 to about 6 carbon atoms, R^3 and R^5 are each independently hydrogen or a linear or branched alkyl group having from 1 to about 6 carbon atoms, and n , y and z are 0; or R^1 , R^2 , R^3 and R^4 are independently hydrogen or a linear or branched alkyl group having from about 1 to about 6 carbon atoms, R^2 is a linear or branched alkylene group having from about 8 to about 25 carbon atoms, and y is 0; or R^1 , R^2 , R^3 and R^4 are independently hydrogen or a linear or branched alkyl group having from about 1 to about 6 carbon atoms, R^2 is a linear or branched alkylene group having from about 1 to about 6 carbon atoms, R^6 in each of the y (R^6O) groups is independently ethylene or propylene, y is an average number from 1 to about 10 and n and z is 0; or R^1 and R^3 are independently a linear or branched alkyl group having from about 8 to about 22 carbon atoms, R^2 is a linear or branched alkylene group having from about 2 to about 6 carbon atoms, and R^4 and R^5 are each independently hydrogen, a linear or branched alkyl group having from 1 to about 6 carbon atoms, or $-(R^6O)_xR^7$, R^6 in each of the x (R^6O) groups is independently ethylene or

64725-903 (D)

63

propylene, R^7 is hydrogen or methyl, x is an average number from 1 to about 15, and n , y and z are 0; or R^1 is a linear or branched alkyl group having from about 1 to about 22 carbon atoms, R^2 is a linear or branched alkylene group having from about 2 to about 6 carbon atoms, R^3 , R^4 and R^5 are each independently hydrogen, X is $-C(O)-$ or $-SO_2-$, n and y are 0 and z is 1. Preferred diamines include Gemini 14-2-14, Gemini 14-3-14, Gemini 10-2-10, Gemini 10-3-10, Gemini 10-4-10, and Gemini 16-2-16 (C_{10} , C_{14} or C_{16} ethylene, propylene or butylene N-methyl diamines from Monsanto), Ethoduomeens™, and Jeffamine™ EDR-148.

In one embodiment, the diamines are included in glyphosate concentrates other than IPA glyphosate, such as glyphosate concentrates containing potassium, di-ammonium, ammonium, sodium, monoethanolamine, n-propylamine, methylamine, ethylamine, hexamethylenediamine, dimethylamine, or trimethylsulfonium glyphosate and mixtures thereof, which contain at least about 20 wt.% glyphosate a.e., more preferably at least about 25%, 30%, 35%, 40%, 45%, 50% or 55 wt.% a.e., or at least about 270 g a.e. glyphosate per liter, more preferably at least 300, 360, 400, 420, 440, 460, 480, 500, 520 or 540 g a.e./l.

(h) amine oxides having the formula:

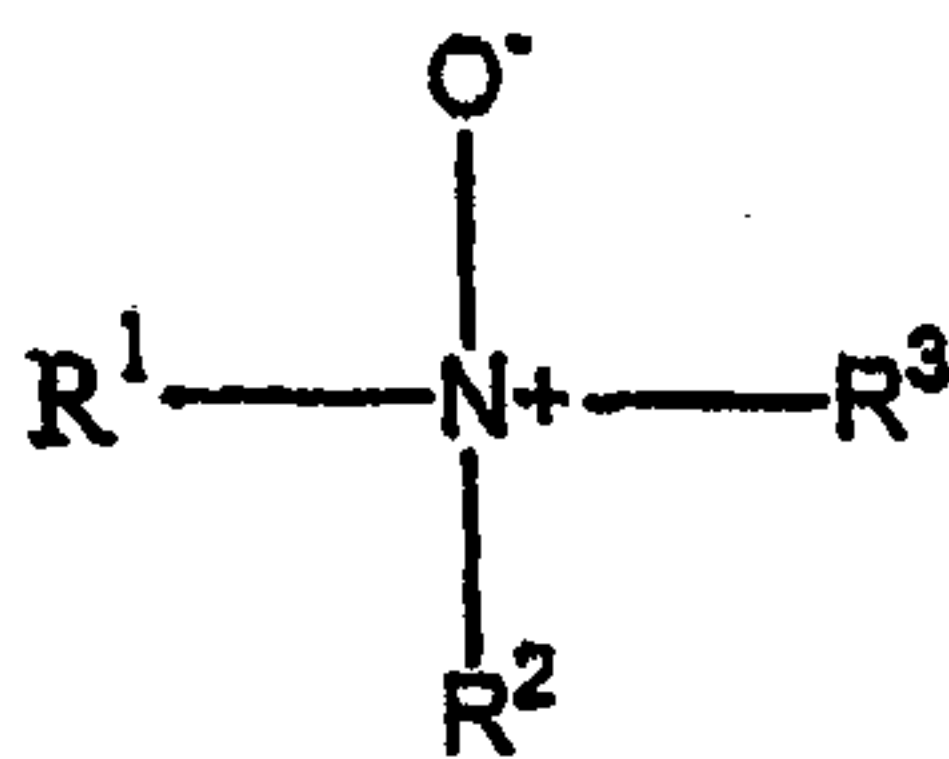

(70)

wherein R^1 , R^2 and R^3 are independently hydrogen, hydrocarbyl or substituted hydrocarbyl, $-(R^4O)_xR^5$, or $-R^6(OR^4)_xOR^5$; R^4 in each of the x (R^4O) groups is independently C_2-C_4 alkylene, R^5 is hydrogen, or a linear or branched alkyl group having from 1 to about 30 carbon atoms, R^6 is hydrocarbylene or substituted hydrocarbylene having from 2 to about 6 carbon atoms, x is an average number from 1 to about 50, and the total number of carbon atoms in R^1 , R^2 and R^3 is at least 8. In this context, preferred R^1 , R^2 , R^3 , and R^6 hydrocarbyl (hydrocarbylene) groups are linear or branched alkyl (alkylene), linear or branched alkenyl (alkenylene), linear or branched alkynyl (alkynylene), aryl (arylene), or aralkyl (aralkylene) groups. Preferably, R^1 and R^2 are independently hydrogen, a linear or branched alkyl or linear or branched alkenyl group having from 1 to about 30 carbon atoms, or $-(R^4O)_xR^5$; R^3 is a linear or branched alkyl or linear or branched

64725-903 (D)

64

alkenyl group having from about 8 to about 30 carbon atoms, R^4 in each of the x (R^4O) groups is independently C_2-C_4 alkylene; R^5 is hydrogen, methyl or ethyl, and x is an average number from 1 to about 30. More preferably, R^1 and R^2 are independently hydrogen, or a linear or branched alkyl group having from 1 to about 6 carbon atoms, and R^3 is a linear or branched alkyl group having from about 8 to about 22 carbon atoms; or R^1 and R^2 are independently $-(R^4O)_xR^5$, R^3 is a linear or branched alkyl group having from about 8 to about 22 carbon atoms, R^4 in each of the x (R^4O) groups is ethylene or propylene, R^5 is hydrogen or methyl, and x is an average number from 1 to about 10. Most preferably, R^1 and R^2 are independently methyl, and R^3 is a linear or branched alkyl group having from about 8 to about 18 carbon atoms; or R^1 and R^2 are independently $-(R^4O)_xR^5$, R^3 is a linear or branched alkyl group having from about 8 to about 18 carbon atoms, R^4 in each of the x (R^4O) groups is ethylene or propylene, R^5 is hydrogen, and x is an average number from 1 to about 5. Commercially available amine oxide surfactants include Chemoxide L70.

In one embodiment, the amine oxides are included in glyphosate concentrates other than IPA glyphosate, such as glyphosate concentrates containing potassium, di-ammonium, ammonium, sodium, monoethanolamine, n-propylamine, methylamine, ethylamine, hexamethylenediamine, dimethylamine, or trimethylsulfonium glyphosate and mixtures thereof, which contain at least about 20 wt.% glyphosate a.e., more preferably at least about 25%, 30%, 35%, 40%, 45%, 50% or 55 wt.% a.e., or at least about 270 g a.e. glyphosate per liter, more preferably at least 300, 360, 400, 420, 440, 460, 480, 500, 520 or 540 g a.e./l.

(i) dialkoxylated amines having the formula:

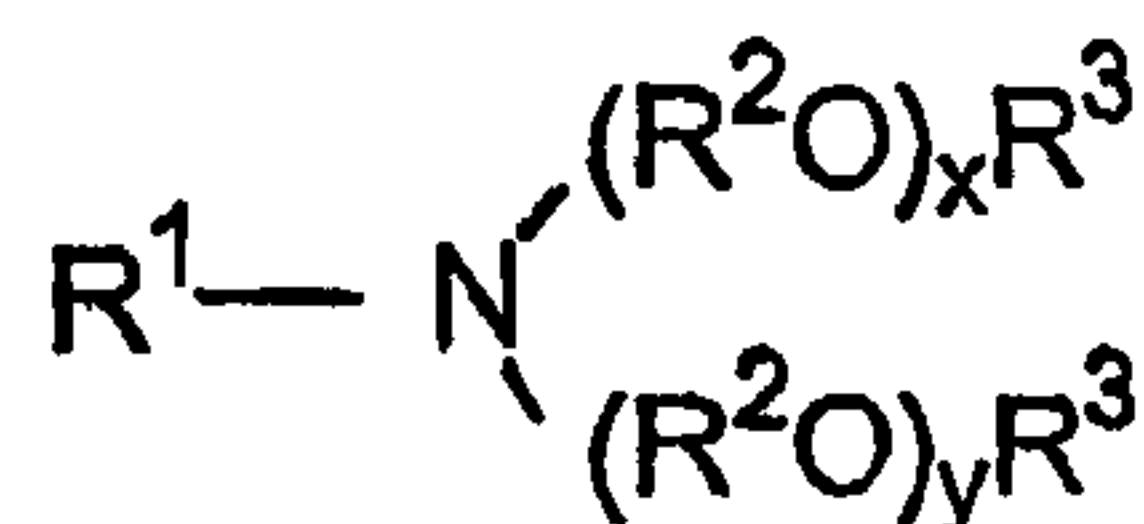

(71)

wherein R^1 is a linear or branched alkyl, linear or branched alkenyl, linear or branched alkynyl, aryl, or aralkyl group having from about 6 to about 30 carbon atoms, or $-R^4SH$, R^2 in each of the x (R^2O) and the y (R^2O) groups is independently C_2-C_4 alkylene, R^3 is hydrogen, or a linear or branched alkyl group having from 1 to about 4 carbon atoms, R^4 is a linear or branched alkyl group having from about 6 to about 30 carbon atoms, and x and y are independently an

64725-903 (D)

65

average number from 1 to about 40. Preferably, R¹ is a linear or branched alkyl or linear or branched alkenyl group having from about 8 to about 30 carbon atoms, R² in each of the x (R²O) and the y (R²O) groups is independently C₂-C₄ alkylene, R³ is hydrogen, methyl or ethyl, and x and y are independently an average number from 1 to about 20. More preferably, R¹ is a linear or branched alkyl group having from about 8 to about 25 carbon atoms, R² in each of the x (R²O) and the y (R²O) groups is independently ethylene or propylene, R³ is hydrogen or methyl, and x and y are independently an average number from 1 to about 10. Even more preferably, R¹ is a linear or branched alkyl group having from about 8 to about 22 carbon atoms, R² in each of the x (R²O) and the y (R²O) groups is independently ethylene or propylene, R³ is hydrogen or methyl, and x and y are independently an average number from 1 to about 5. Preferred commercially available dialkoxylated amines include Trymeen™ 6617 (from Cognis) and Ethomeen™ C/12, C/15, C/20, C/25, T/12, T/15, T/20 and T/25 (from Akzo Nobel).

Such dialkoxylated amines are preferably used in potassium glyphosate concentrates containing at least 550 grams a.e. per liter of potassium glyphosate, and more preferably at least 560, 570 or 580 grams a.e. per liter of potassium glyphosate. It is preferred that such potassium glyphosate concentrates contain from about 550 to about 600 grams a.e. per liter of potassium glyphosate.

Alternatively, the dialkoxylated amines are preferably formulated in potassium glyphosate concentrates containing at least 320 grams a.e. per liter of potassium glyphosate, that are free of alkyl polyglycosides, or that only contain alkyl polyglycosides having a light color of less than 10, preferably less than 9, 8, 7, 6, or 5 as measured using a Gardner colorimeter. In one embodiment, such concentrates include at least 330, 340, 350, 360, 370, 380, 390, 400, 410, 420, 430, 440, 450, 460, 470, 480, 490, 500, 510, 520, 530, 540, 550, 560, 570 or 580 grams a.e. per liter of potassium glyphosate. It is preferred that such potassium glyphosate concentrates contain from about 400 to about 600 grams a.e. per liter of potassium glyphosate, more preferably from about 450 to about 600, about 500 to about 600, about 540 to about 600 or about 550 to about 600 grams a.e. per liter of potassium glyphosate.

Alternatively, the dialkoxylated amines are preferably incorporated in potassium glyphosate concentrates containing from about 20 to about 150 grams per liter of total surfactant in the formulation, more preferably from about 20 to about 130 grams per liter. In another embodiment, the dialkoxylated amines are

64725-903 (D)

66

incorporated in potassium glyphosate concentrates containing from about 20 to about 150 grams per liter of total surfactant in the formulation and at least 320 grams a.e. per liter of potassium glyphosate, more preferably at least 330, 340, 350, 360, 370, 380, 390, 400, 410, 420, 430, 440, 450, 460, 470, 480, 490, 500, 510, 520, 530, 540, 550, 560, 570 or 580 grams a.e. per liter of potassium glyphosate. It is preferred that such potassium glyphosate concentrates contain from about 400 to about 600 grams a.e. per liter of potassium glyphosate, more preferably from about 450 to about 600, about 500 to about 600, about 540 to about 600 or about 550 to about 600 grams a.e. per liter of potassium glyphosate.

and (j) aminated alkoxyated alcohols having the following chemical structure:

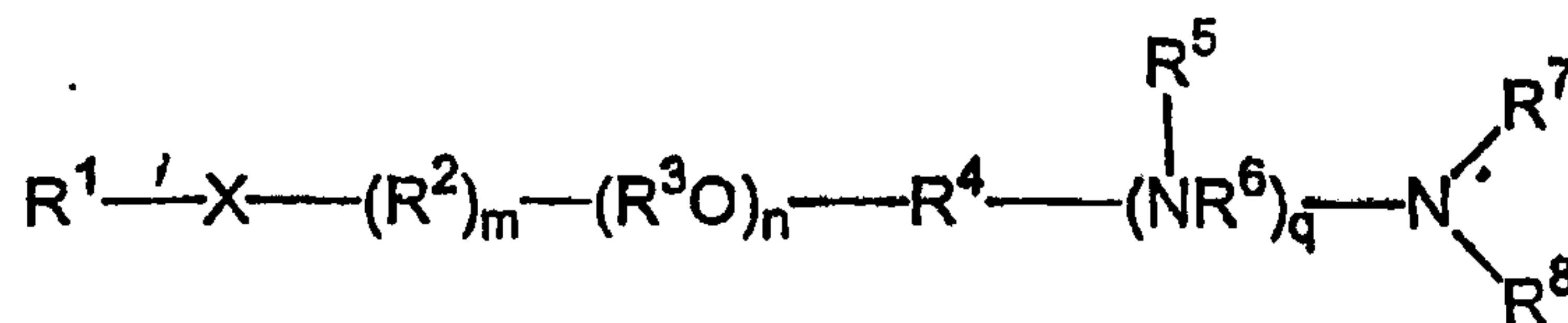

(72)

wherein R^1 , R^7 , R^8 , and R^9 are each independently hydrogen, hydrocarbyl or substituted hydrocarbyl having from 1 to about 30 carbon atoms, or $-(R^{11})_s(R^3O)_vR^{10}$; X is $-O-$, $-OC(O)-$, $-C(O)O-$, $-N(R^{12})C(O)-$, $-C(O)N(R^{12})-$, $-S-$, $-SO-$, $-SO_2-$ or $-N(R^9)-$; R^3 in each of the n (R^3O) groups and the v (R^3O) groups is independently C_2-C_4 alkylene; R^{10} is hydrogen, or a linear or branched alkyl group having from 1 to about 30 carbon atoms; n is an average number from 1 to about 60; v is an average number from 1 to about 50; R^2 and R^{11} are each independently hydrocarbylene or substituted hydrocarbylene having from 1 to about 6 carbon atoms; R^4 is hydrocarbylene or substituted hydrocarbylene having from 2 to about 6 carbon atoms; R^{12} is hydrogen or hydrocarbyl or substituted hydrocarbyl having from 1 to about 30 carbon atoms; m and s are each independently 0 or 1; R^6 is hydrocarbylene or substituted hydrocarbylene having from 2 to about 30 carbon atoms, $-C(=NR^{12})-$, $-C(S)-$, or $-C(O)-$; q is an integer from 0 to 5; and R^5 is hydrogen or hydrocarbyl or substituted hydrocarbyl having from 1 to about 30 carbon atoms. In this context, preferred R^1 , R^2 , R^4 , R^5 , R^6 , R^7 , R^8 , R^9 , R^{11} and R^{12} hydrocarbyl (hydrocarbylene) groups are linear or branched alkyl (alkylene), linear or branched alkenyl (alkenylene), linear or branched alkynyl (alkynylene), aryl (arylene), or aralkyl (aralkylene) groups.

64725-903 (D)

67

In one embodiment, the aminated alkoxyated alcohols are included in glyphosate concentrates other than IPA glyphosate, such as glyphosate concentrates containing potassium, di-ammonium, ammonium, sodium, monoethanolamine, n-propylamine, methylamine, ethylamine, hexamethylenediamine, dimethylamine, or trimethylsulfonium glyphosate and mixtures thereof, which contain at least about 20 wt.% glyphosate a.e., more preferably at least about 25%, 30%, 35%, 40%, 45%, 50% or 55 wt.% a.e., or at least about 270 g a.e. glyphosate per liter, more preferably at least 300, 360, 400, 420, 440, 460, 480, 500, 520 or 540 g a.e./l.

A subclass of such cationic surfactants includes a monoalkoxyated amine having the formula:

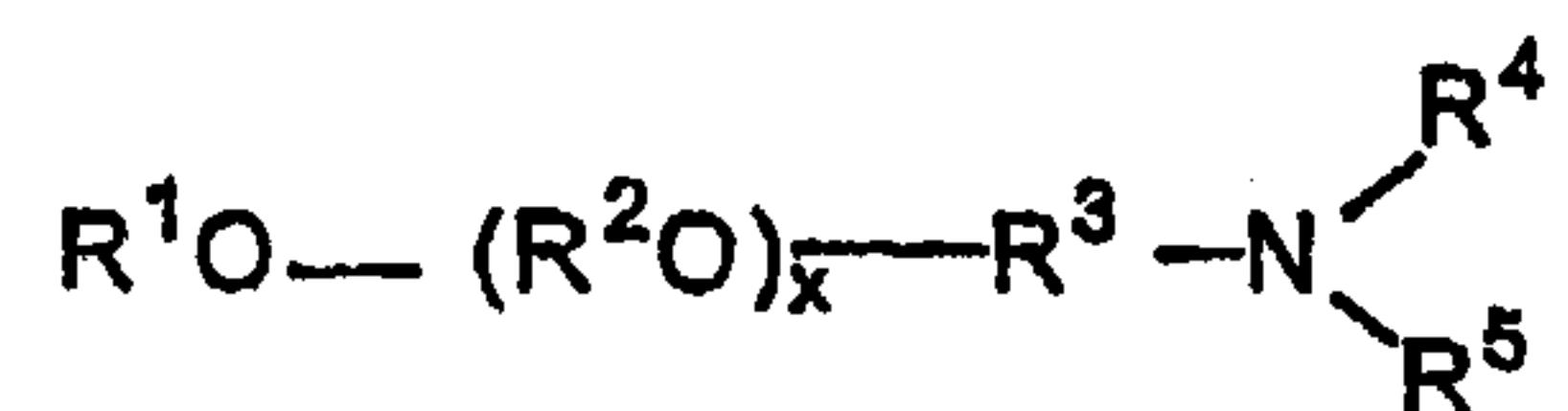

(73)

wherein R^1 is hydrogen or hydrocarbyl or substituted hydrocarbyl having from 1 to about 30 carbon atoms; R^2 in each of the x (R^2O) and y (R^2O) groups is independently C_2-C_4 alkylene; R^3 is hydrocarbylene or substituted hydrocarbylene having from 2 to about 30 carbon atoms; R^4 and R^5 are each independently hydrogen, hydrocarbyl or substituted hydrocarbyl having from 1 to about 30 carbon atoms, $-(R^6)_n-(R^2O)_yR^7$, or R^4 and R^5 , together with the nitrogen atom to which they are attached, form a cyclic or heterocyclic ring; R^6 is hydrocarbylene or substituted hydrocarbylene having from 1 to about 30 carbon atoms; R^7 is hydrogen or a linear or branched alkyl group having 1 to about 4 carbon atoms, n is 0 or 1, x and y are independently an average number from 1 to about 60. In this context, preferred R^1 , R^3 , R^4 , R^5 , and R^6 hydrocarbyl (hydrocarbylene) groups are linear or branched alkyl (alkylene), linear or branched alkenyl (alkenylene), linear or branched alkynyl (alkynylene), aryl (arylene), or aralkyl (aralkylene) groups. Preferably, R^1 is a linear or branched alkyl or linear or branched alkenyl group having from about 8 to about 25 carbon atoms, R^2 in each of the x (R^2O) groups is independently C_2-C_4 alkylene, R^3 is a linear or branched alkylene group having from 2 to about 20 carbon atoms, R^4 and R^5 are each independently hydrogen or a linear or branched alkyl group having from 1 to about 6 carbon atoms, and x is an average number from 1 to about 30. More preferably, R^1 is a linear or branched alkyl group having from about 12 to about 22 carbon atoms, R^2 in each of the x (R^2O) groups is independently ethylene or propylene, R^3 is a

64725-903 (D)

68

linear or branched alkylene group having from 2 to about 6 carbon atoms, R^4 and R^5 are each independently hydrogen, methyl, or tris(hydroxymethyl)methyl, and x is an average number from about 2 to about 30. Even more preferably, R^1 is a linear or branched alkyl group having from about 12 to about 18 carbon atoms, R^2 in each of the x (R^2O) groups is independently ethylene or propylene, R^3 is ethylene or propylene, R^4 and R^5 are each independently hydrogen, methyl or tris(hydroxymethyl)methyl, and x is an average number from about 4 to about 20. Most preferably, R^1 is a linear or branched alkyl group having from about 12 to about 18 carbon atoms, R^2 in each of the x (R^2O) groups is independently ethylene or propylene, R^3 is ethylene, R^4 and R^5 are methyl, and x is an average number from about 4 to about 20. Preferred monoalkoxylated amines include PEG 13 or 18 C_{14-15} ether propylamines and PEG 7, 10, 15 or 20 C_{16-18} ether propylamines (from Tomah) and PEG 13 or 18 C_{14-15} ether dimethyl propylamines and PEG 10, 15 or 20 or 25 C_{16-18} ether dimethyl propylamines (from Tomah) and Surfonic™/AGM-550 from Huntsman.

In one embodiment, the monoalkoxylated amines are included in glyphosate concentrates other than IPA glyphosate, such as glyphosate concentrates containing potassium, di-ammonium, ammonium, sodium, monoethanolamine, n-propylamine, methylamine, ethylamine, hexamethylenediamine, dimethylamine, or trimethylsulfonium glyphosate and mixtures thereof, which contain at least about 20 wt.% glyphosate a.e., more preferably at least about 25%, 30%, 35%, 40%, 45%, 50% or 55 wt.% a.e., or at least about 270 g a.e. glyphosate per liter, more preferably at least 300, 360, 400, 420, 440, 460, 480, 500, 520 or 540 g a.e./l.

Quaternary ammonium, sulfonium and sulfoxonium salts are also effective cationic surfactants in forming potassium glyphosate concentrates and have a chemical structure:

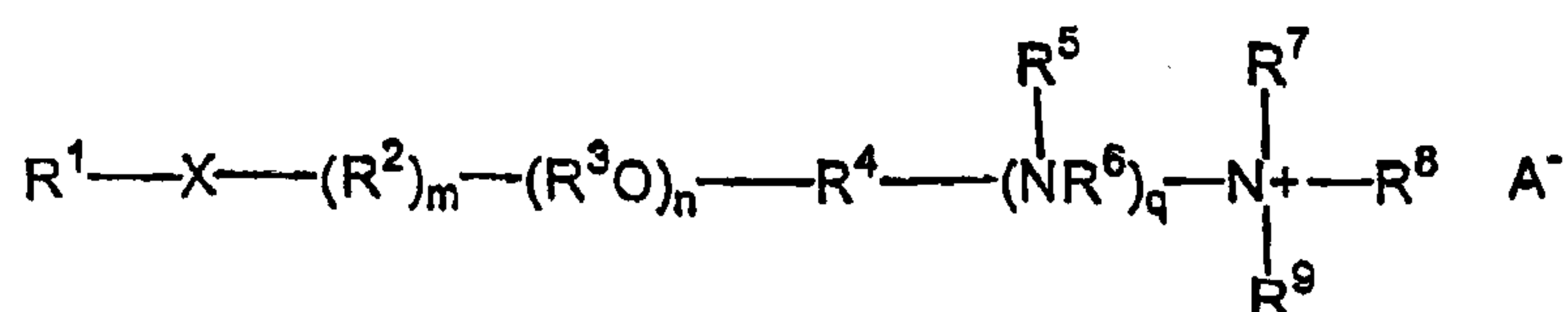

(74)

or

64725-903 (D)

69

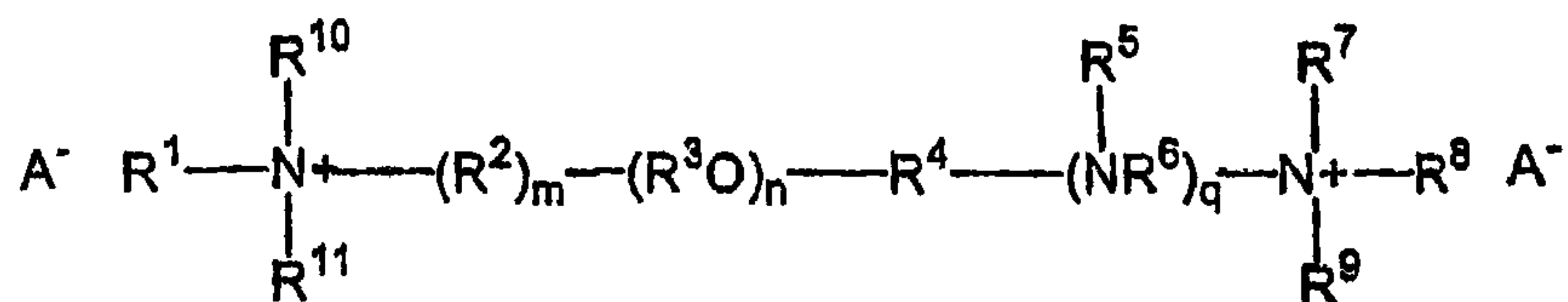

(75)

or

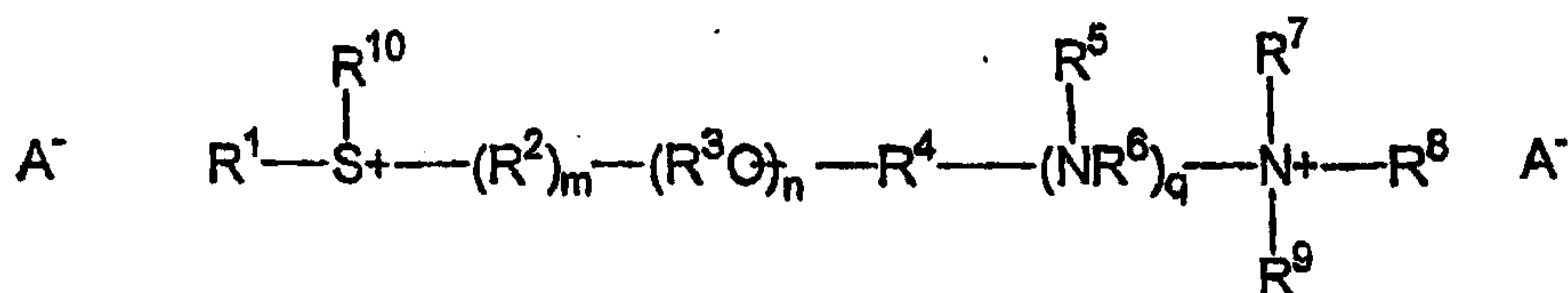

(76)

or

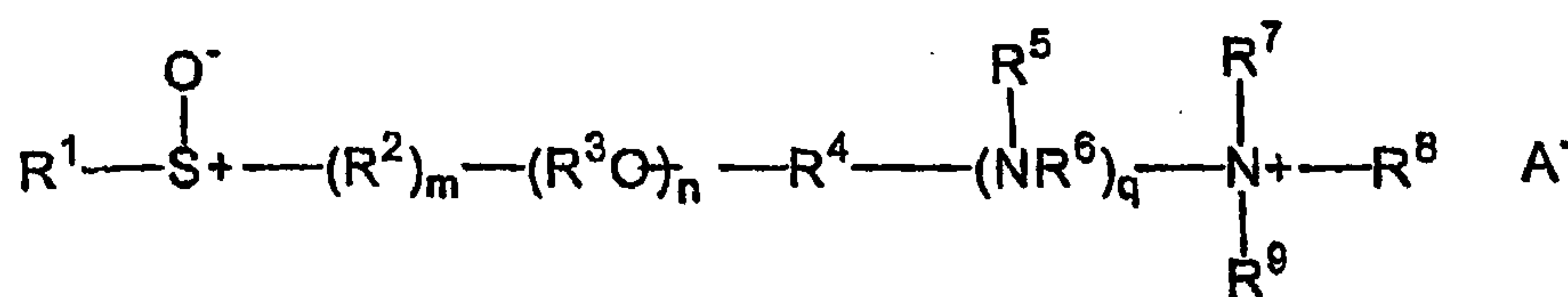

(77)

wherein R^1 , R^7 , R^8 , R^9 , R^{10} and R^{11} are independently hydrogen, hydrocarbyl or substituted hydrocarbyl having from 1 to about 30 carbon atoms, or $-(R^{13})_s(R^3O)_vR^{12}$; X is $-O-$, $-OC(O)-$, $-N(R^{14})C(O)-$, $-C(O)N(R^{14})-$, $-C(O)O-$, or $-S-$; R^3 in each of the n (R^3O) groups and v (R^3O) groups is independently C_2 - C_4 alkylene; R^{12} is hydrogen, or a linear or branched alkyl group having from 1 to about 30 carbon atoms; n is an average number from 1 to about 60; v is an average number from 1 to about 50; R^2 and R^{13} are each independently hydrocarbylene or substituted hydrocarbylene having from 1 to about 6 carbon atoms; m and s are each independently 0 or 1; R^4 is hydrocarbylene or substituted hydrocarbylene having from 2 to about 6 carbon atoms; R^5 is hydrocarbylene or substituted hydrocarbylene having from 2 to about 30 carbon atoms, $-C(=NR^{12})-$, $-C(S)-$, or $-C(O)-$; R^{14} is hydrogen or hydrocarbyl or substituted hydrocarbyl having from 1 to about 30 carbon atoms, q is an integer from 0 to 5; R^5 is hydrogen or hydrocarbyl

64725-903 (D)

70

or substituted hydrocarbyl having from 1 to about 30 carbon atoms; and each A⁻ is an agriculturally acceptable anion. In this context, preferred R¹, R², R⁴, R⁵, R⁶, R⁷, R⁸, R⁹, R¹⁰, R¹¹, R¹³, and R¹⁴ hydrocarbyl (hydrocarbylene) groups are linear or branched alkyl (alkylene), linear or branched alkenyl (alkenylene), linear or branched alkynyl (alkynylene), aryl (arylene), or aralkyl (aralkylene) groups.

Another cationic surfactant effective in any glyphosate formulations is a diamine or diammonium salt having the formula:

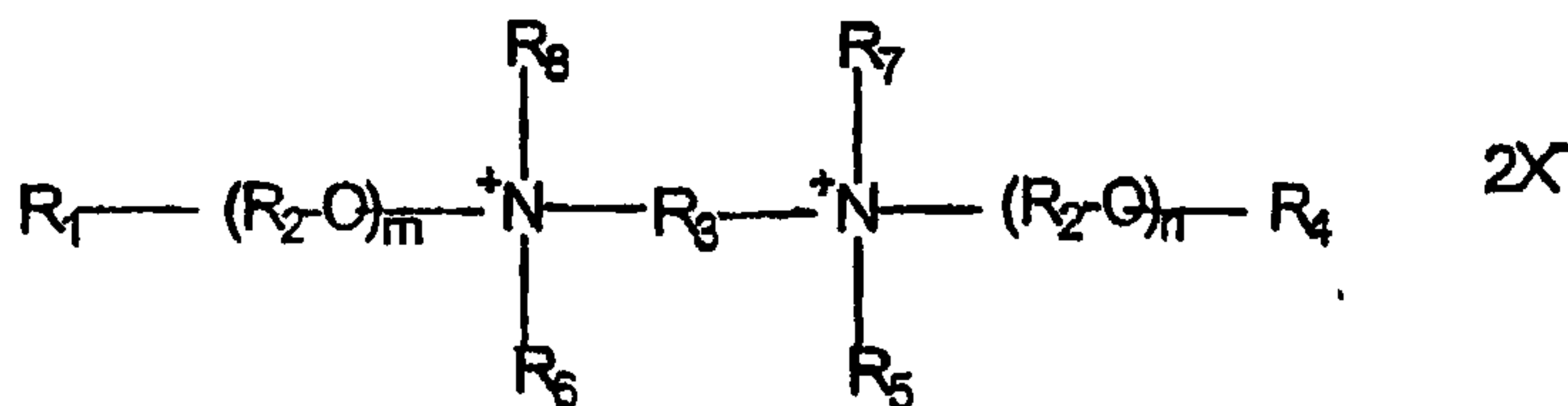
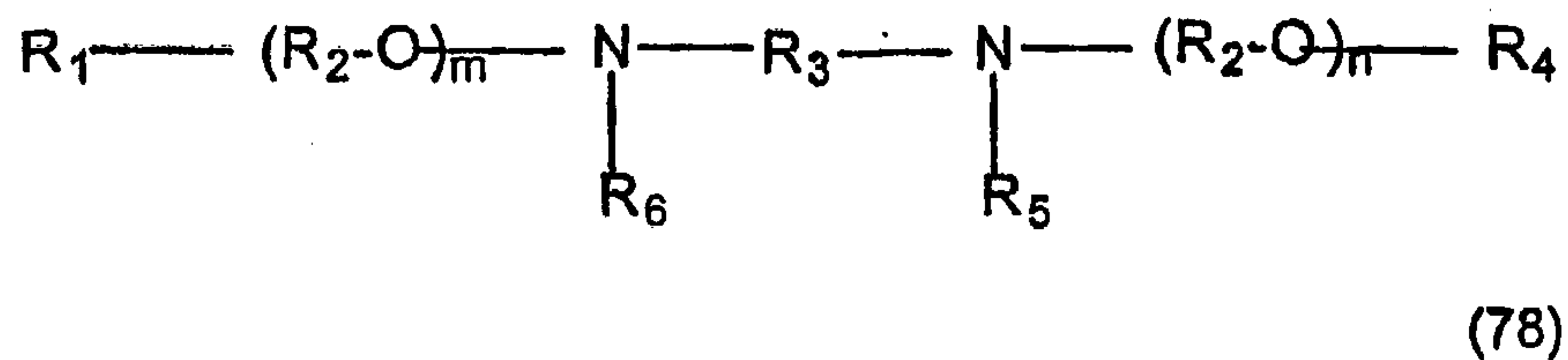

(79)

wherein R¹, R⁴, R⁵, R⁶, R⁷ and R⁸ are independently hydrogen or hydrocarbyl or substituted hydrocarbyl having from 1 to about 30 carbon atoms, R² in each of the m (R²O) and n (R²O) groups and R⁹ are independently C₂-C₄ alkylene, R³ is hydrocarbylene or substituted hydrocarbylene having from about 2 to about 6 carbon atoms or -(R²O)_pR₉, m and n are individually an average number from 0 to about 50, and p is an average number from 0 to about 60. In this context, preferred R¹, R³, R⁴, R⁵, R⁶, R⁷ and R⁸ hydrocarbyl (hydrocarbylene) groups are linear or branched alkyl (alkylene), linear or branched alkenyl (alkenylene), linear or branched alkynyl (alkynylene), aryl (arylene), or aralkyl (aralkylene) groups. In one embodiment of formula (DA), R³ is hydrocarbylene having from about 2 to about 6 carbon atoms, and the remaining groups are as defined above.

Preferred nonionic surfactants for such glyphosate concentrates include alkoxyated alcohols having the formula:

64725-903 (D)

71

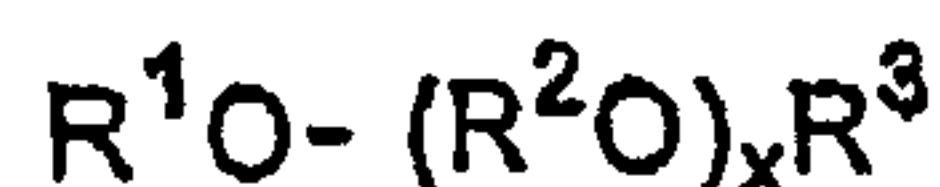

(80)

wherein R^1 is hydrocarbyl or substituted hydrocarbyl having from 1 to about 30 carbon atoms, R^2 in each of the x (R^2O) groups is independently C_2-C_4 alkylene, R^3 is hydrogen, or a linear or branched alkyl group having from 1 to about 4 carbon atoms, and x is an average number from 1 to about 60. In this context, preferred R^1 hydrocarbyl groups are linear or branched alkyl, linear or branched alkenyl, linear or branched alkynyl, aryl, or aralkyl groups. Preferably, R^1 is a linear or branched alkyl or linear or branched alkenyl group having from about 8 to about 30 carbon atoms, R^2 in each of the x (R^2O) groups is independently C_2-C_4 alkylene, R^3 is hydrogen, methyl or ethyl, and x is an average number from about 5 to about 50. More preferably, R^1 is a linear or branched alkyl group having from about 8 to about 25 carbon atoms, R^2 in each of the x (R^2O) groups is independently ethylene or propylene, R^3 is hydrogen or methyl, and x is an average number from about 8 to about 40. Even more preferably, R^1 is a linear or branched alkyl group having from about 12 to about 22 carbon atoms, R^2 in each of the x (R^2O) groups is independently ethylene or propylene, R^3 is hydrogen or methyl, and x is an average number from about 8 to about 30. Preferred commercially available alkoxyated alcohols include Procol™ LA-15 (from Protameen), Brij™ 35, Brij™ 76, Brij™ 78, Brij™ 97 and Brij™ 98 (from Sigma Chemical Co.), Neodol™ 25-12 (from Shell), Hexotol™ CA-10, Hexotol™ CA-20, Hexotol™ CS-9, Hexotol™ CS-15, Hexotol™ CS-20, Hexotol™ CS-25, Hexotol™ CS-30, and Plurafac™ A38 (from BASF), ST-8303 (from Cognis), and Arosurf™ 66 E20 (from Witco/Crompton).

In one embodiment, the alkoxyated alcohols are included in glyphosate concentrates other than IPA glyphosate, such as glyphosate concentrates containing potassium, di-ammonium, ammonium, sodium, monoethanolamine, n-propylamine, methylamine, ethylamine, hexamethylenediamine, dimethylamine, or trimethylsulfonium glyphosate and mixtures thereof, which contain at least about 20 wt.% glyphosate a.e., more preferably at least about 25%, 30%, 35%, 40%, 45%, 50% or 55 wt.% a.e., or at least about 270 g a.e. glyphosate per liter, more preferably at least 300, 360, 400, 420, 440, 460, 480, 500, 520 or 540 g a.e./l.

Other nonionic surfactants for use in such glyphosate formulations include alkoxyated dialkylphenols having the formula:

64725-903 (D)

72

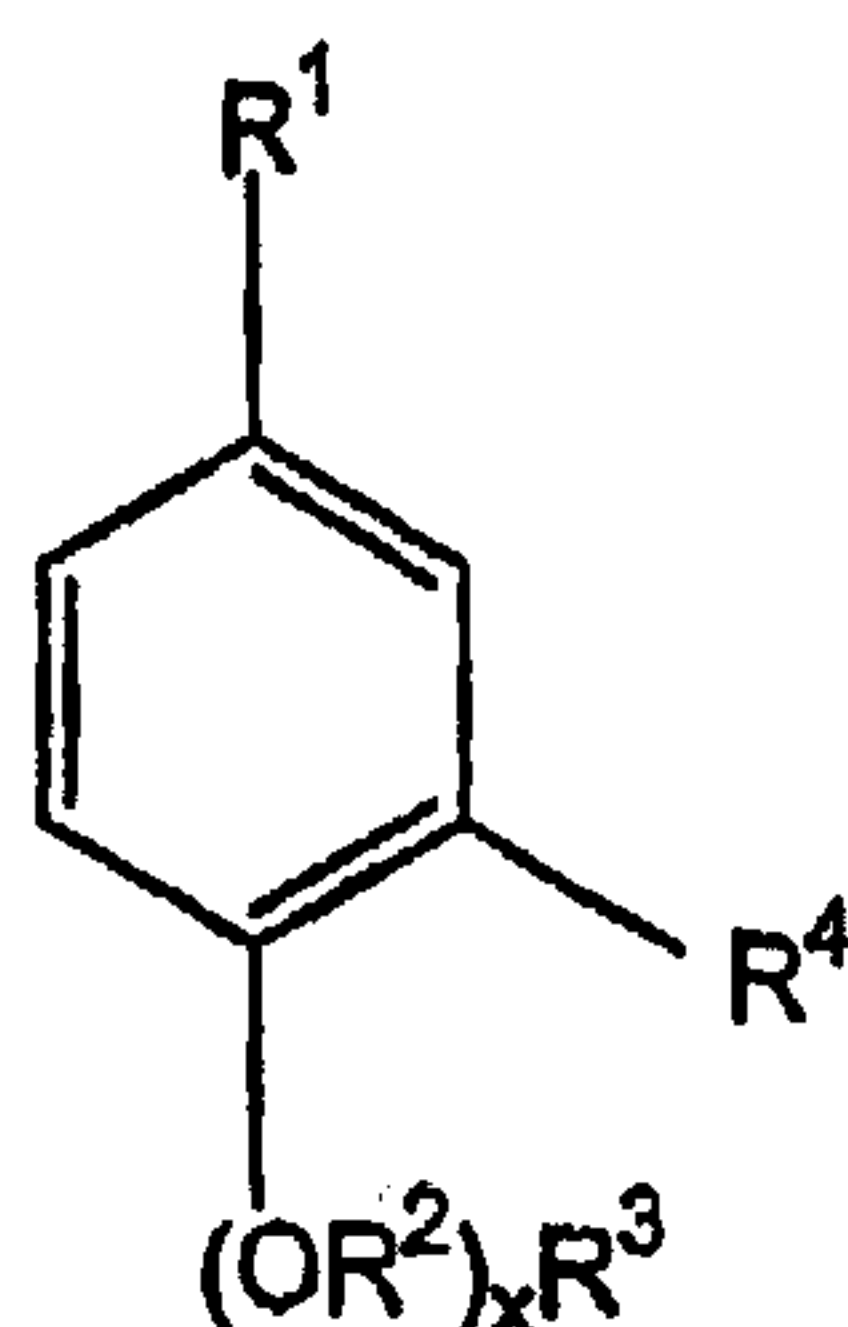

(81)

wherein R¹ and R⁴ are independently hydrogen, or a linear or branched alkyl group having from 1 to about 30 carbon atoms and at least one of R¹ and R⁴ is an alkyl group, R² in each of the x (R²O) groups is independently C₂-C₄ alkylene, R³ is hydrogen, or a linear or branched alkyl group having from 1 to about 4 carbon atoms, and x is an average number from 1 to about 60. Preferably, R¹ and R⁴ are independently linear or branched alkyl groups having from 8 to about 30 carbon atoms, R² in each of the x (R²O) groups is independently C₂-C₄ alkylene, R³ is hydrogen, methyl or ethyl, and x is an average number from about 5 to about 50. More preferably, R¹ and R⁴ are independently linear or branched alkyl groups having from about 8 to about 22 carbon atoms, R² in each of the x (R²O) groups is independently ethylene or propylene, R³ is hydrogen or methyl, and x is an average number from about 8 to about 40. Even more preferably, R¹ and R⁴ are independently linear or branched alkyl groups having from about 8 to about 16 carbon atoms, R² in each of the x (R²O) groups is independently ethylene or propylene, R³ is hydrogen or methyl, and x is an average number from about 10 to about 30. Preferred commercially available alkoxyated dialkylphenols include ethoxylated dinonyl phenols such as Surfonic™ DNP 100, Surfonic™ DNP 140, and Surfonic™ DNP 240 (from Huntsman).

In one embodiment, the phenols are included in glyphosate concentrates other than IPA glyphosate, such as glyphosate concentrates containing potassium, di-ammonium, ammonium, sodium, monoethanolamine, n-propylamine, methylamine, ethylamine, hexamethylenediamine, dimethylamine, or trimethylsulfonium glyphosate and mixtures thereof, which contain at least about 20 wt.% glyphosate a.e., more preferably at least about 25%, 30%, 35%, 40%, 45%, 50% or 55 wt.% a.e., or at least about 270 g a.e. glyphosate per liter, more preferably at least 300, 360, 400, 420, 440, 460, 480, 500, 520 or 540 g a.e./l.

64725-903 (D)

73

Preferred anionic surfactants effective in forming potassium glyphosate formulations include saturated carboxylic acids such as butyric, caproic, caprylic, capric, lauric, palmitic, myristic or stearic acid, and unsaturated carboxylic acids such as palmitoleic, oleic, linoleic or linolenic acid. Preferred carboxylic acids include palmitic, oleic or stearic acid. Other preferred anionic surfactants include alkyl sulfates such as sodium lauryl sulfate, and alkyl alkoxyated phosphates having the formulae:

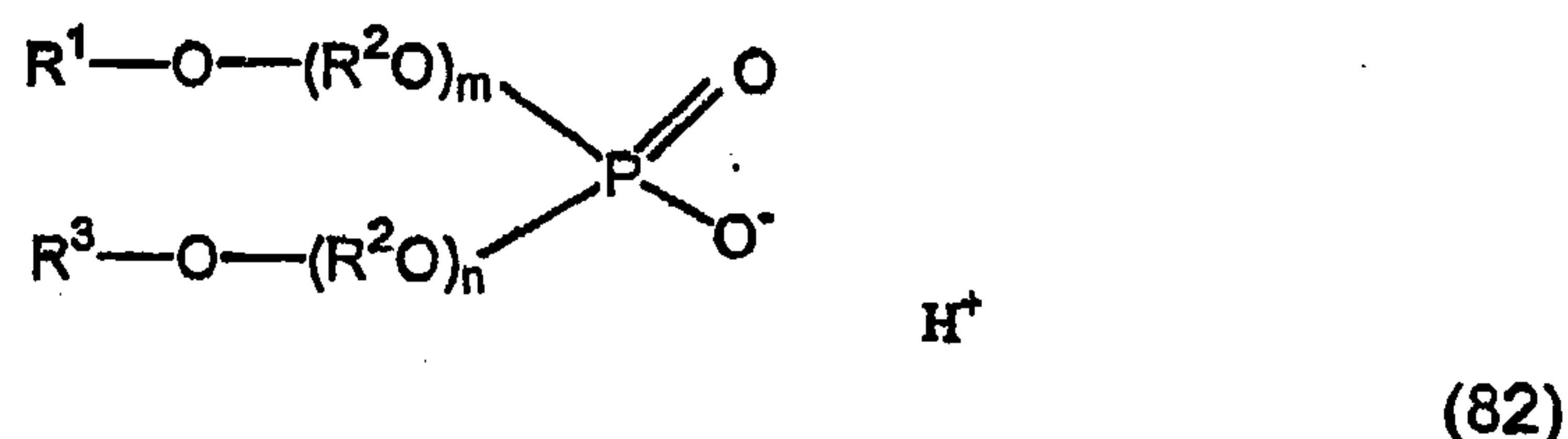

wherein R^1 and R^3 are independently a linear or branched alkyl, linear or branched alkenyl, linear or branched alkynyl, aryl, or aralkyl group having from about 4 to about 30 carbon atoms; R^2 in each of the m (R^2O) and the n (R^2O) groups is independently $\text{C}_2\text{-C}_4$ alkylene; and m and n are independently from 1 to about 30; or

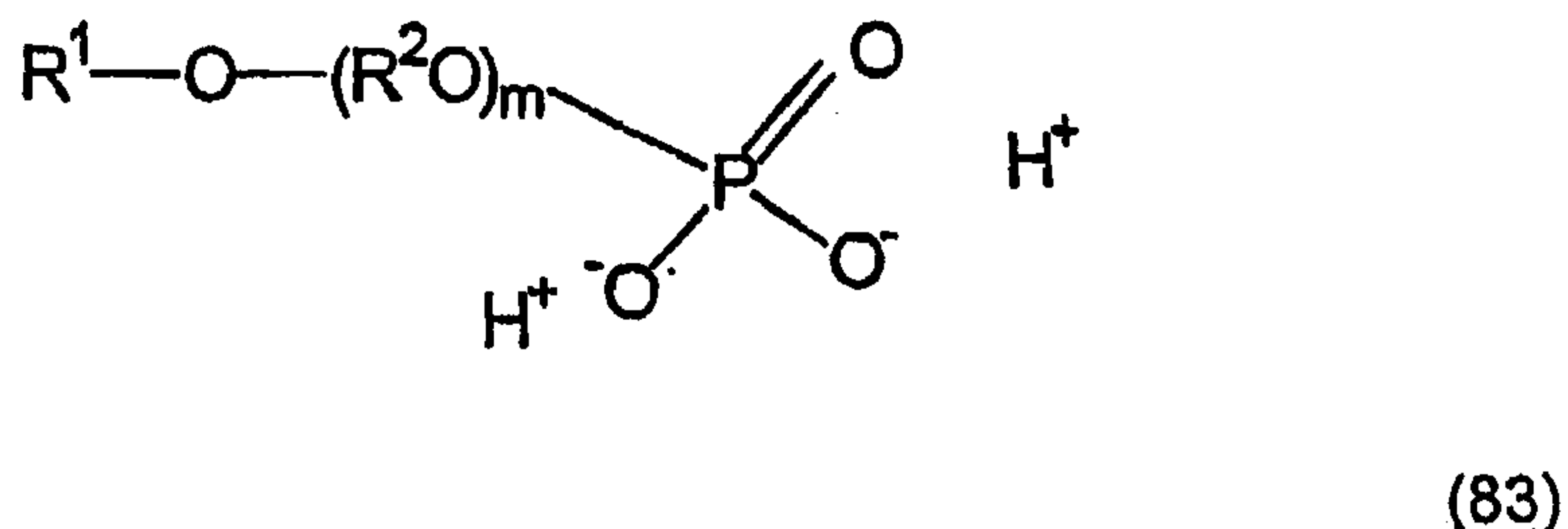

wherein R^1 is a linear or branched alkyl, linear or branched alkenyl, linear or branched alkynyl, aryl, or aralkyl group having from about 8 to about 30 carbon atoms; R^2 in each of the m (R^2O) groups is independently $\text{C}_2\text{-C}_4$ alkylene; and m is from 1 to about 30. Representative alkyl alkoxyated phosphates include oleth-10 phosphate, oleth-20 phosphate and oleth-25 phosphate.

Exemplary surfactants that may be used in accordance with the present invention include the following species:

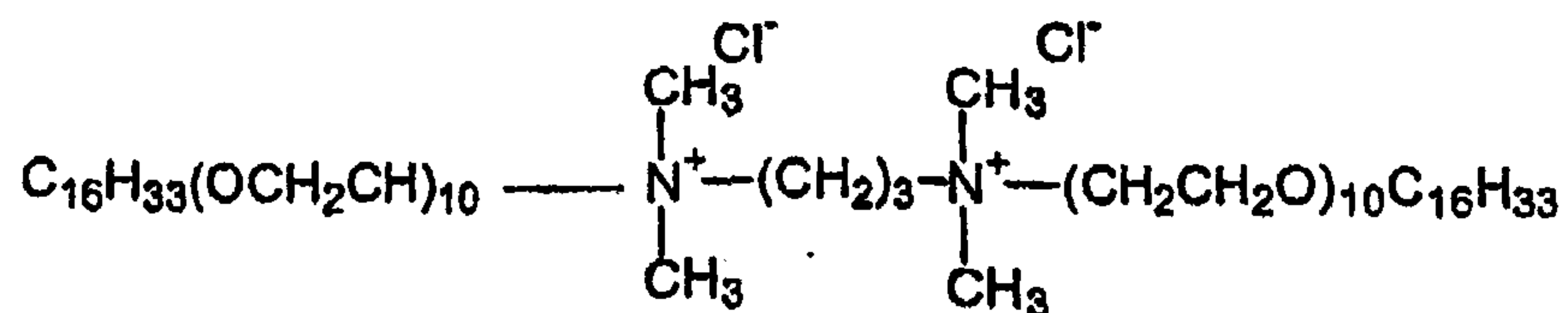

64725-903 (D)

74

(84)

and

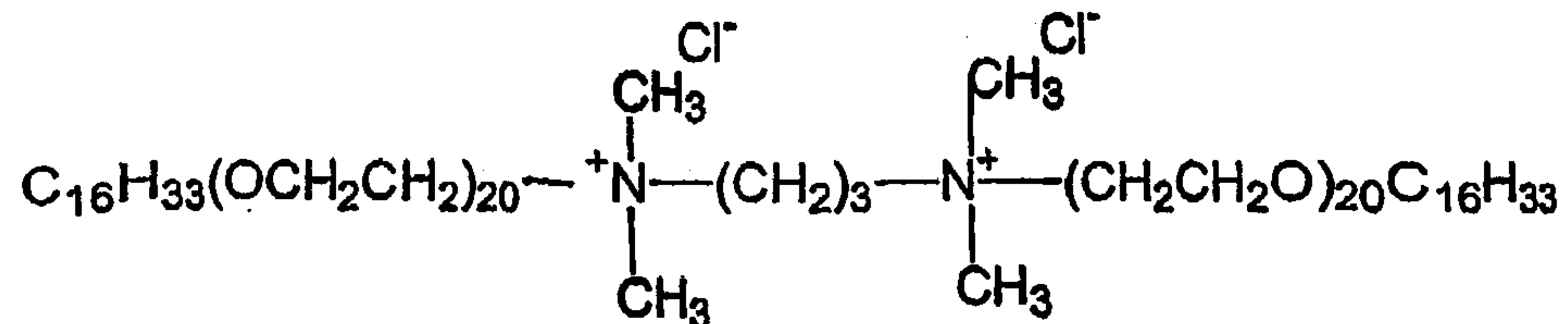

(85)

In either aqueous concentrated formulations or dry formulations of the present invention, the ratio (by weight) of the glyphosate a.e. to the surfactant is typically in the range of from about 1:1 to about 20:1, preferably from about 2:1 to about 10:1, more preferably from about 2:1 to about 8:1, still more preferably from about 2:1 to about 6:1, and still more preferably from about 3:1 to about 6:1.

The density of any glyphosate-containing formulation of the invention is preferably at least 1.210 grams/liter, more preferably at least about 1.215, 1.220, 1.225, 1.230, 1.235, 1.240, 1.245, 1.250, 1.255, 1.260, 1.265, 1.270, 1.275, 1.280, 1.285, 1.290, 1.295, 1.300, 1.305, 1.310, 1.315, 1.320, 1.325, 1.330, 1.335, 1.340, 1.345, 1.350, 1.355, 1.360, 1.365, 1.370, 1.375, 1.380, 1.385, 1.390, 1.395, 1.400, 1.405, 1.410, 1.415, 1.420, 1.425, 1.430, 1.435, 1.440, 1.445, or 1.450 grams/liter.

As further discussed herein, other additives, adjuvants, or ingredients may be introduced into the formulations of the present invention to improve certain properties of the resulting formulations. Although the formulations of the present invention generally show good overall stability and viscosity properties without the addition of any further additives, the addition of a solubilizer (also commonly referred to as a cloud point enhancer or stabilizer) can significantly improve the properties of the formulations of the present invention. Suitable solubilizers for use with the novel formulations of the present invention include, for example, cocoamine (Armeen C), dimethylcocoamine (Arquad DMCD), cocoammonium chloride (Arquad C), PEG 2 cocoamine (Ethomeen C12), PEG 5 tallowamine (Ethomeen T15), and PEG 5 cocoamine (Ethomeen C15), all of which are manufactured by Akzo Nobel (California).

Additionally, it has been found that the addition of a C₄ to C₁₆ alkyl or aryl amine compound, or the corresponding quaternary ammonium compound, greatly

64725-903 (D)

75

enhances the compatibility of certain glyphosate salts (e.g., potassium or isopropylamine) with surfactants that otherwise exhibit low or marginal compatibility at a given glyphosate loading. Suitable alkyl or aryl amine compounds may also contain 0 to about 5 EO groups. Preferred alkylamine compounds include C₆ to C₁₂ alkylamines having 0 to 2 EO groups. Similarly, etheramine compounds having 4 to 12 carbons and 0 to about 5 EO groups, as well as the corresponding quaternary ammonium compounds, also enhance the compatibility of such formulations. In one embodiment, the compounds which enhance the compatibility of such surfactants include amines or quaternary ammonium salts having the formula:

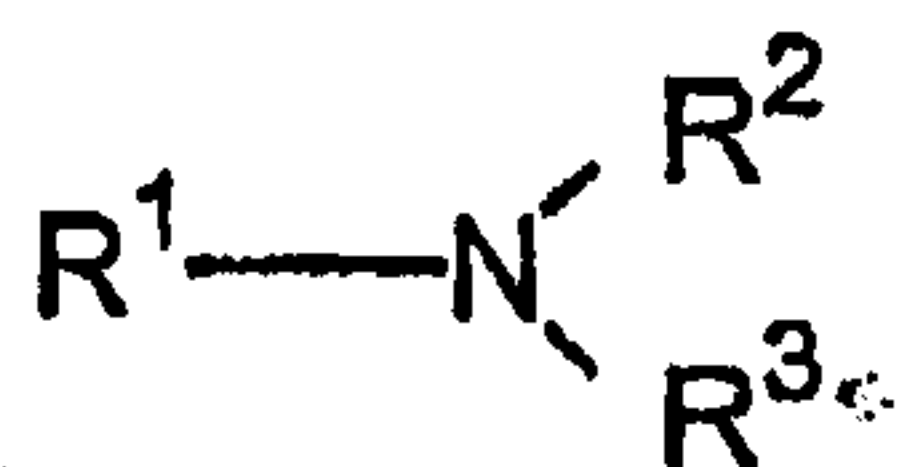

(86)

or

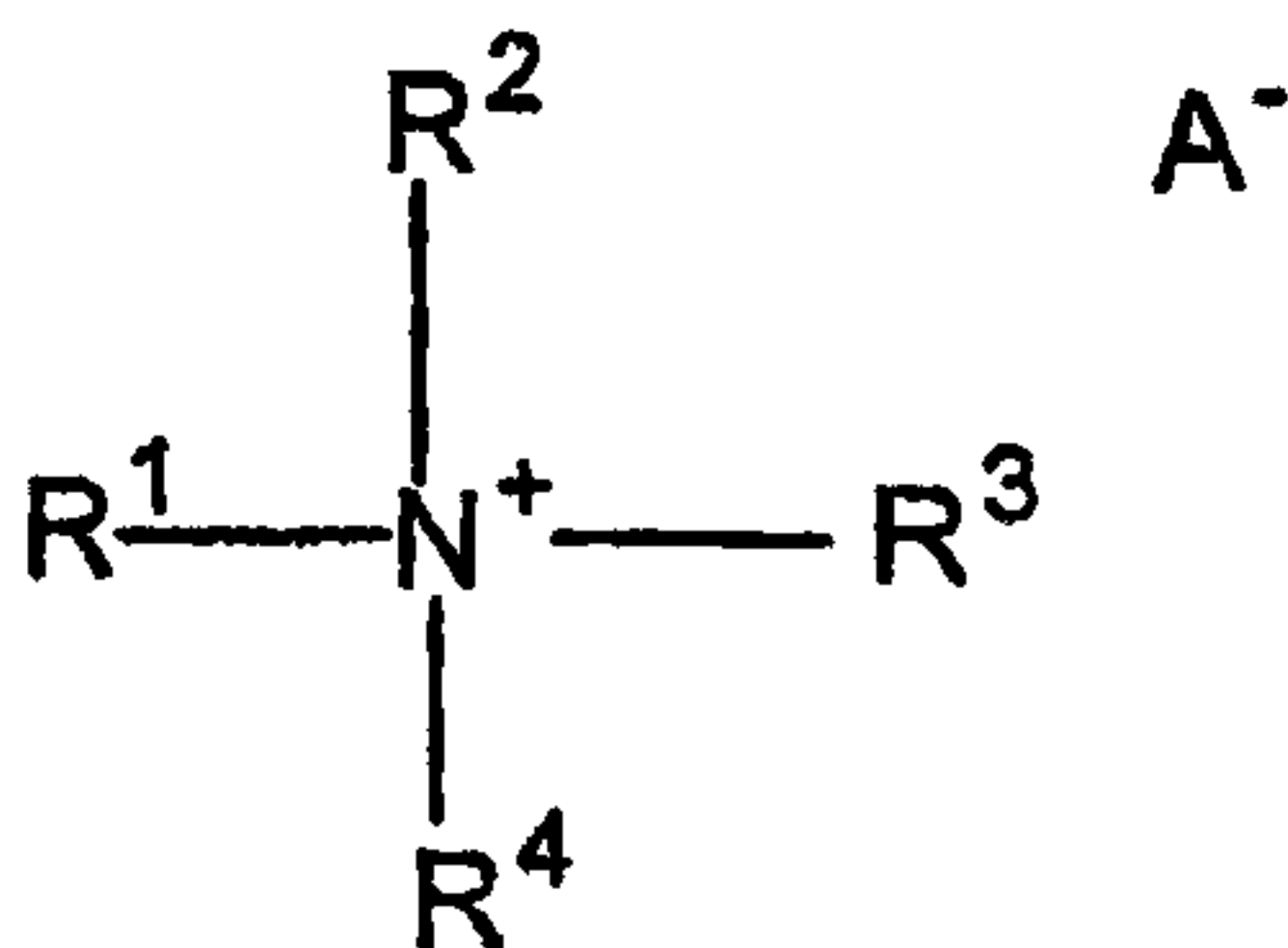

(87)

or

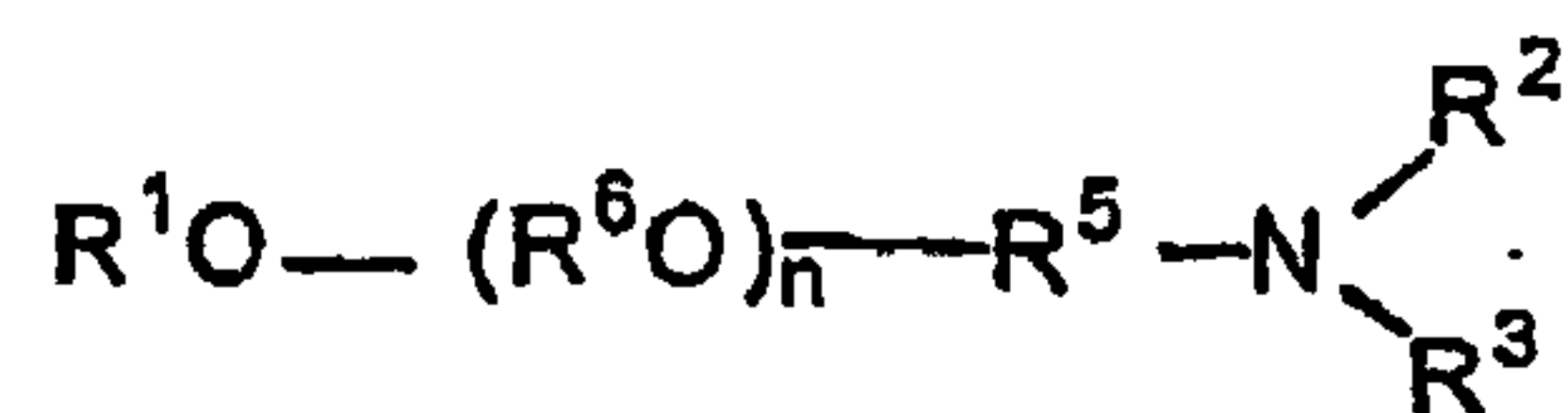

(88)

or

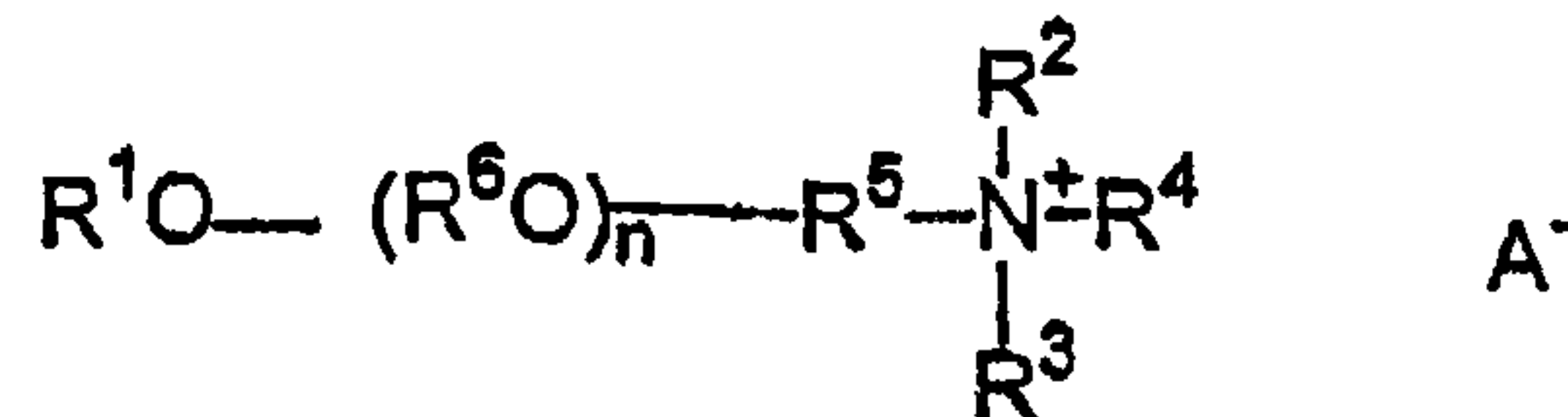

(89)

64725-903 (D)

76

wherein R^1 is linear or branched alkyl or aryl having from about 4 to about 16 carbon atoms, R^2 is hydrogen, methyl, ethyl, or $-(CH_2CH_2O)_xH$, R^3 is hydrogen, methyl, ethyl, or $-(CH_2CH_2O)_yH$ wherein the sum of x and y is not more than about 5; R^4 is hydrogen or methyl; R^5 in each of the n (R^5O) groups is independently C_2 - C_4 alkylene; R^6 is hydrocarbylene or substituted hydrocarbylene having from 2 to about 6 carbon atoms; and A^- is an agriculturally acceptable anion.

Also provided by the present invention is a herbicidal method comprising diluting with a suitable volume of water a herbicidally effective volume of a composition as provided herein to form an application composition, and applying the application composition to foliage of a plant or plants.

DEFINITIONS

The terms "hydrocarbon" and "hydrocarbyl" as used herein describe organic compounds or radicals consisting exclusively of the elements carbon and hydrogen. These moieties include alkyl, alkenyl, alkynyl, and aryl moieties. These moieties also include alkyl, alkenyl, alkynyl, and aryl moieties substituted with other aliphatic or cyclic hydrocarbon groups, such as alkaryl, alkenaryl and alkynaryl. Unless otherwise indicated, these moieties preferably comprise 1 to 30 carbon atoms.

The term "hydrocarbylene" as used herein describes radicals joined at two ends thereof to other radicals in an organic compound, and which consist exclusively of the elements carbon and hydrogen. These moieties include alkylene, alkenylene, alkynylene, and arylene moieties. These moieties also include alkyl, alkenyl, alkynyl, and aryl moieties substituted with other aliphatic or cyclic hydrocarbon groups, such as alkaryl, alkenaryl and alkynaryl. Unless otherwise indicated, these moieties preferably comprise 1 to 30 carbon atoms.

The "substituted hydrocarbyl" moieties described herein are hydrocarbyl moieties which are substituted with at least one atom other than carbon, including moieties in which a carbon chain atom is substituted with a hetero atom such as nitrogen, oxygen, silicon, phosphorous, boron, sulfur, or a halogen atom. These substituents include halogen, heterocyclo, alkoxy, alkenoxy, alkynoxy, aryloxy, hydroxy, protected hydroxy, ketal, acyl, acyloxy, nitro, amino, amido, cyano, thiol, acetal, sulfoxide, ester, thioester, ether, thioether, hydroxyalkyl, urea, guanidine, amidine, phosphate, amine oxide, and quaternary ammonium salt.

The "substituted hydrocarbylene" moieties described herein are hydrocarbylene moieties which are substituted with at least one atom other than carbon, including moieties in which a carbon chain atom is substituted with a hetero atom such as nitrogen, oxygen, silicon, phosphorous, boron, sulfur, or a halogen atom. These substituents include halogen, heterocyclo, alkoxy, alkenoxy, alkynoxy, aryloxy, hydroxy, protected hydroxy, ketal, acyl, acyloxy, nitro, amino, amido, cyano, thiol, acetal, sulfoxide, ester, thioester, ether, thioether, hydroxyalkyl, urea, guanidine, amidine, phosphate, amine oxide, and quaternary ammonium salt.

Unless otherwise indicated, the alkyl groups described herein are preferably lower alkyl containing from one to 18 carbon atoms in the principal chain and up to 30 carbon atoms. They may be straight or branched chain or cyclic and include methyl, ethyl, propyl, isopropyl, n-butyl, isobutyl, hexyl, 2-ethylhexyl, and the like.

Unless otherwise indicated, the alkenyl groups described herein are preferably lower alkenyl containing from two to 18 carbon atoms in the principal chain and up to 30 carbon atoms. They may be straight or branched chain or cyclic and include ethenyl, propenyl, isopropenyl, butenyl, isobutenyl, hexenyl, and the like.

Unless otherwise indicated, the alkynyl groups described herein are preferably lower alkynyl containing from two to 18 carbon atoms in the principal chain and up to 30 carbon atoms. They may be straight or branched chain and include ethynyl, propynyl, butynyl, isobutynyl, hexynyl, and the like.

The terms "aryl" as used herein alone or as part of another group denote optionally substituted homocyclic aromatic groups, preferably monocyclic or bicyclic groups containing from 6 to 12 carbons in the ring portion, such as phenyl, biphenyl, naphthyl, substituted phenyl, substituted biphenyl or substituted naphthyl. Phenyl and substituted phenyl are the more preferred aryl.

The term "aralkyl" as used herein denotes a group containing both alkyl and aryl structures such as benzyl.

As used herein, the alkyl, alkenyl, alkynyl, aryl and aralkyl groups can be substituted with at least one atom other than carbon, including moieties in which a carbon chain atom is substituted with a hetero atom such as nitrogen, oxygen, silicon, phosphorous, boron, sulfur, or a halogen atom. These substituents include hydroxy, nitro, amino, amido, nitro, cyano, sulfoxide, thiol, thioester, thioether, ester and ether, or any other substituent which can increase the

64725-903 (D)

78

compatibility of the surfactant and/or its efficacy enhancement in the potassium glyphosate formulation without adversely affecting the storage stability of the formulation.

The terms "halogen" or "halo" as used herein alone or as part of another group refer to chlorine, bromine, fluorine, and iodine. Fluorine substituents are often preferred in surfactant compounds.

Unless otherwise indicated, the term "hydroxyalkyl" includes alkyl groups substituted with at least one hydroxy group, and includes bis(hydroxyalkyl)alkyl, tris(hydroxyalkyl)alkyl and poly(hydroxyalkyl)alkyl groups. Preferred hydroxyalkyl groups include hydroxymethyl ($-\text{CH}_2\text{OH}$), and hydroxyethyl ($-\text{C}_2\text{H}_4\text{OH}$), bis(hydroxymethyl)methyl ($-\text{CH}(\text{CH}_2\text{OH})_2$), and tris(hydroxymethyl)methyl ($-\text{C}(\text{CH}_2\text{OH})_3$).

The term "cyclic" as used herein alone or as part of another group denotes a group having at least one closed ring, and includes alicyclic, aromatic (arene) and heterocyclic groups.

The terms "heterocyclo" or "heterocyclic" as used herein alone or as part of another group denote optionally substituted, fully saturated or unsaturated, monocyclic or bicyclic, aromatic or nonaromatic groups having at least one heteroatom in at least one ring, and preferably 5 or 6 atoms in each ring. The heterocyclo group preferably has 1 or 2 oxygen atoms, 1 or 2 sulfur atoms, and/or 1 to 4 nitrogen atoms in the ring, and may be bonded to the remainder of the molecule through a carbon or heteroatom. Exemplary heterocyclo include heteroaromatics such as furyl, thienyl, pyridyl, oxazolyl, pyrrolyl, indolyl, quinolinyl, or isoquinolinyl and the like, and non-aromatic heterocyclics such as tetrahydrofuryl, tetrahydrothienyl, piperidinyl, pyrrolidino, etc. Exemplary substituents include one or more of the following groups: hydrocarbyl, substituted hydrocarbyl, keto, hydroxy, protected hydroxy, acyl, acyloxy, alkoxy, alkenoxy, alkynoxy, aryloxy, halogen, amido, amino, nitro, cyano, thiol, thioester, thioether, ketal, acetal, ester and ether.

The term "heteroaromatic" as used herein alone or as part of another group denote optionally substituted aromatic groups having at least one heteroatom in at least one ring, and preferably 5 or 6 atoms in each ring. The heteroaromatic group preferably has 1 or 2 oxygen atoms, 1 or 2 sulfur atoms, and/or 1 to 4 nitrogen atoms in the ring, and may be bonded to the remainder of the molecule through a carbon or heteroatom. Exemplary heteroaromatics include furyl, thienyl, pyridyl, oxazolyl, pyrrolyl, indolyl, quinolinyl, or isoquinolinyl

and the like. Exemplary substituents include one or more of the following groups: hydrocarbyl, substituted hydrocarbyl, keto, hydroxy, protected hydroxy, acyl, acyloxy, alkoxy, alkenoxy, alkynoxy, aryloxy, halogen, amido, amino, nitro, cyano, thiol, thioether, thioester, ketal, acetal, ester and ether.

The term "acyl," as used herein alone or as part of another group, denotes the moiety formed by removal of the hydroxyl group from the group -COOH of an organic carboxylic acid, e.g., RC(O)-, wherein R is R¹, R¹O-, R¹R²N-, or R¹S-, R¹ is hydrocarbyl, heterosubstituted hydrocarbyl, or heterocyclo and R² is hydrogen, hydrocarbyl or substituted hydrocarbyl.

The term "acyloxy," as used herein alone or as part of another group, denotes an acyl group as described above bonded through an oxygen linkage (-O-), e.g., RC(O)O- wherein R is as defined in connection with the term "acyl."

The term "pesticide" includes chemicals and microbial agents used as active ingredients of products for control of crop and lawn pests and diseases, animal ectoparasites, and other pests in public health. The term also includes plant growth regulators, pest repellants, synergists, herbicide safeners (which reduce the phytotoxicity of herbicides to crop plants) and preservatives, the delivery of which to the target may expose dermal and especially ocular tissue to the pesticide. Such exposure can arise by drift of the pesticide from the delivery means to the person performing the application of the pesticide or being present in the vicinity of an application.

When a maximum or minimum "average number" is recited herein with reference to a structural feature such as oxyethylene units or glucoside units, it will be understood by those skilled in the art that the integer number of such units in individual molecules in a surfactant preparation typically varies over a range that can include integer numbers greater than the maximum or smaller than the minimum "average number". The presence in a composition of individual surfactant molecules having an integer number of such units outside the stated range in "average number" does not remove the composition from the scope of the present invention, so long as the "average number" is within the stated range and other requirements are met.

As indicated above, concentrated aqueous solutions of glyphosate potassium salt have been found to have exceptionally high specific gravity. Table 1 shows, by way of example, specific gravities measured for 30% glyphosate a.e. by weight solutions of the potassium salt of glyphosate by comparison with organic ammonium and other salts of current or previous commercial interest.

Specific gravities are measured using a Mettler DA-300 Density/Specific Gravity Meter.

Table 1. Specific gravity (20/15.6°C) of 30% a.e. by weight glyphosate monobasic salt solutions.

Salt	Specific Gravity
potassium	1.2539
monoethanolammonium (MEA)	1.2357
isopropylammonium (IPA)	1.1554
n-propylammonium	1.1429
methylammonium	1.1667
ethylammonium	1.1599
ammonium	1.1814
trimethylsulfonium (TMS)	1.1904

Thus 1 liter of 30% a.e. by weight glyphosate potassium salt solution at 20°C contains approximately 376 g glyphosate a.e./l, whereas 1 liter of 30% a.e. by weight glyphosate IPA salt solution at 20°C contains approximately 347 g glyphosate a.e./l. In other words, at equal a.e. weight concentration, the potassium salt solution delivers about 8% more glyphosate a.e. per liter.

The higher specific gravity of solutions of the potassium salt becomes of particular value in surfactant-containing solutions, where the maximum glyphosate concentration is constrained not only by the limit of solubility of the potassium salt in water but also by the limits of surfactant compatibility. In such solutions, the advantages of the potassium salt can mean that (a) a higher maximum glyphosate a.e. weight/volume concentration is achieved than with the IPA salt in the presence of the same compatible surfactant at the same percent surfactant concentration, (b) at given weight/volume concentrations of glyphosate a.e. and surfactant, improved storage-stability is achieved over a corresponding composition prepared with the IPA salt, and/or (c) at given weight/volume concentrations of glyphosate a.e. and surfactant, improved pouring and pumping properties are achieved over a corresponding composition prepared with the IPA salt.

The advantages of compositions of the present invention are reduced as glyphosate concentration is decreased and are only marginal at a glyphosate

concentration lower than about 360 g a.e./l, i.e., lower than the concentration found in such commercial glyphosate IPA salt products as Roundup® herbicide. In preferred compositions of the invention, glyphosate concentration is not lower than 400 g a.e./l or about 420 g a.e./l, in particularly preferred compositions not lower than about 440, 460 or 480 g a.e./l, for example about 480 to about 540 g a.e./l. It is believed that the upper limit of glyphosate concentration in a storage-stable surfactant-containing composition of the invention is in excess of about 650 g a.e./l, this limit being a consequence of the solubility limit of glyphosate potassium salt in water, compounded by further limitation due to the presence of surfactant.

It is expected that the closer to this upper limit of glyphosate concentration, the less the amount of surfactant that can be accommodated. In some instances, this small amount of surfactant is likely to be inadequate to give reliable enhancement of the herbicidal efficacy of the glyphosate to an acceptable degree. However, in certain special-purpose applications where the composition is to be diluted with a relatively small amount of water, for plant treatment at a volume of, for example, about 10 to about 50 l/ha, the surfactant concentration in a concentrate composition of the invention can usefully be as low as about 20 g/l. Such special-purpose applications include rope-wick, control droplet application and ultra-low-volume aerial spraying. For general-purpose application, typically by spraying following dilution with about 50 to about 1000 l/ha, most commonly about 100 to about 400 l/ha, of water, the surfactant concentration in a concentrate composition of the invention is preferably about 60 to about 300 g/l, and more preferably about 60 to 200 g/l.

The herbicidal formulations of the present invention include at least one surfactant that, in combination with glyphosate or a salt or ester thereof and upon application of the formulation to a plant or an application mixture prepared by dilution of the formulation with water, forms anisotropic aggregates comprising the surfactant on the foliage (epicuticular wax) of the plant. In some formulations of the present invention, a surfactant, in combination with glyphosate or a salt or ester thereof and upon application of the formulation to a plant or an application mixture prepared by dilution of the formulation with water, forms liquid crystals comprising the surfactant on the foliage of the plant (epicuticular wax). In other formulations of the present invention, a surfactant, in combination with glyphosate or a salt or ester thereof and upon application of the formulation to a plant or an application mixture prepared by dilution of the formulation with water forms liquid

64725-903 (D)

82

crystals comprising the surfactant both on the foliage of the plant (epicuticular wax) and with the plant itself (intracuticular liquid crystals). In other formulations of the present invention, a herbicidal formulation comprising an aqueous mixture containing glyphosate or a salt or ester thereof and a surfactant contains liquid crystals comprising the surfactant.

Suitable salt forms of glyphosate which may be used in accordance with the formulations of the present invention include, for example, alkali metal salts, for example sodium and potassium salts, ammonium salts, di-ammonium salts such as dimethylammonium, alkylamine salts, for example dimethylamine and isopropylamine salts, alkanolamine salts, for example ethanolamine salts, alkylsulfonium salts, for example trimethylsulfonium salts, sulfoxonium salts, and mixtures or combinations thereof. Various commercial glyphosate formulations sold to date by Monsanto Company include ammonium salts, sodium salts, and isopropylamine salts. Glyphosate formulations sold to date by Zeneca have included trimethylsulfonium salts. Especially preferred glyphosate salts useful in the novel formulations of the present invention include the potassium salt, isopropylamine salt, ammonium salt, di-ammonium salt, sodium salt, monoethanolamine salt, and trimethylsulfonium salt. The potassium salt, sodium salt, ammonium salt and di-ammonium salts are preferred as formulations of these glyphosate salts are most likely to form liquid crystals.

In addition to the glyphosate or salt or ester thereof, the herbicidal formulations of the present invention also comprise at least one surfactant. In one embodiment of the present invention, the nature of the surfactant and the composition of the herbicidal formulation is such that upon application of the formulation to a plant or an application mixture prepared by dilution of the formulation with water, anisotropic aggregates comprising the surfactant are formed on the waxy cuticle (epicuticular) of the plant. These anisotropic aggregates are formed on the foliage of the plant regardless whether a second surfactant is present in the formulation. The anisotropic aggregates may form immediately upon application to the foliage of the plant, or may form as water is evaporated from the formulation present upon the foliage after application. Further, anisotropic aggregates may also form in the concentrate herbicidal formulations.

To determine whether a herbicidal formulation comprising glyphosate or a salt or ester thereof and a surfactant forms anisotropic aggregates on the foliage

64725-903 (D)

83

of a plant comprising the surfactant, the following birefringence testing procedure may be utilized.

First, a wax-coated slide is prepared. A preferred wax for preparing the slide is a blend of carnauba wax and beeswax in a weight/weight ratio of approximately 10:1, respectively. A clear wax mixture is prepared consisting of about 5% carnauba wax and about 0.5% beeswax in isopropanol, and is maintained at a temperature of approximately 82°C. The end of a glass 2.4 cm x 7.2 cm microscope slide is immersed perpendicularly in the wax mixture to a depth of approximately one-third of the length of the slide. After about 10 to 15 seconds, the slide is very slowly and steadily withdrawn from the wax mixture and allowed to cool, leaving a wax layer deposited on both faces of the slide.

Visual examination of the slide can give a preliminary indication of the thickness and uniformity of the wax coating. If imperfections are evident the slide is rejected. If the slide shows no obvious imperfections, the wax coating is carefully removed from one face of the slide by wiping with acetone. Further evaluation of the acceptability of the wax-coated slide for the test is done by examining the slide under a microscope. The slide is selected for use in the test if, on microscopic examination using a 4.9x objective, the wax coating is uniformly thick and there is uniform density of wax particles across the slide. Preference is for a coating that has few observable wax particles and exhibits a very dark field when examined under polarized light.

The next stage in the procedure is to conduct the test. For this purpose, samples of the glyphosate herbicidal formulation containing one or more surfactants are diluted, if necessary, to 15% to 20% by weight of the glyphosate acid equivalent. A reference sample is prepared consisting of 41% by weight of glyphosate IPA salt in aqueous solution.

The following instrumentation, or equivalent, items are required or useful for the test procedure:

Nikon SMZ-10A stereoscopic microscope equipped for polarized light observation, photomicrography, and video observation and recording.

3CCD MTI camera.

Diagnostic Instruments 150 IL-PS power supply.

Sony Trinitron color video monitor, model PVM-1353MD.

Mitsubishi time-lapse video cassette recorder, model HS-S5600.

Hewlett Packard Pavillion 7270 computer, with Windows 95 and Image-Pro Plus version 2.0 electronic imaging program installed.

anisotropic aggregates is the observation of birefringence (y/n) 5-20 minutes after deposition of the test drop on the wax-coated slide.

Herbicidal formulations of the present invention that form epicuticular anisotropic aggregates have substantially improved performance over herbicidal formulations currently available. Without being bound to a particular theory, it is believed that the epicuticular anisotropic aggregates may create or enlarge hydrophilic channels through the epicuticular waxy surface of the plant cuticle. These created or enlarged transcuticular channels through the waxy surface may facilitate the mass transfer of glyphosate through the epicuticular wax of the plant cuticle and into the plant more rapidly than in a system without anisotropic aggregates. It is further believed that the majority of the anisotropic aggregates present on the epicuticular surface are present in a form other than a simple micelle, such as a bilayer or multilamellar structure as they tend to form complex structures such as cylindrical, discotic, or ribbon like structures. "Majority" means that more than 50% by weight of the surfactant is present in the form of complex aggregates other than simple micelles. Preferably, more than 75% by weight of the surfactant is present in the form of complex aggregates other than simple micelles. The anisotropic aggregates of the present invention typically have a diameter of at least about 20 nanometers, preferably at least about 30 nanometers.

Regarding the formation of anisotropic aggregates comprising a surfactant in the presence of glyphosate, critical packing parameter (P), which is defined as:

$$P=V/A$$

where V is the volume of the hydrophobic tail of the molecule, l is the effective length of the hydrophobic tail, and A is the area occupied by the hydrophilic headgroup, may be an important aspect. It is believed that amphiphilic substances useful in forming anisotropic aggregates have a critical packing parameter greater than about 1/3.

In a preferred embodiment wherein anisotropic aggregates are formed on epicuticular wax of the plant cuticle, the surfactant comprising the anisotropic aggregates is an amphiphilic substance comprising a compound having a cationic headgroup and a hydrophobic tail. Without being bound to a particular theory, it is believed that the cationic group enhances the initial adhesion to the leaf

surface, since the majority of the such surfaces carry an overall negative charge. Further, it is believed that the cationic group contributes to the hydrophilicity of the transcuticular channels in the epicuticular wax formed or enlarged by the surfactants of the present invention. Cationic groups attract water molecules which further enlarge the hydrophilic channels and thereby provide an improved pathway of entry for glyphosate, which is polar.

Surfactants that are effective in forming anisotropic aggregates in the presence of glyphosate include nonionic, cationic, anionic and amphoteric surfactants and mixtures thereof.

Mixtures of surfactants as described above are also effective in forming anisotropic aggregates. Preferred mixtures include an alkoxyated alcohol nonionic surfactant and a dialkoxyated quaternary ammonium, monoalkoxyated quaternary ammonium, quaternary ammonium, dialkoxyated amine, diamine, or alkyl choline halide (e.g., lauryl choline chloride) cationic surfactant. Other preferred mixtures contain: a phospholipid amphoteric surfactant and a dialkoxyated amine or dialkoxyated quaternary ammonium cationic surfactant, a fluorinated quaternary ammonium surfactant such as Fluorad™ 754, or an alkoxyated alcohol nonionic surfactant; or a carboxylic acid anionic surfactant and a dialkoxyated amine cationic surfactant. Examples of such preferred mixtures include Hetoxol™ CS-20 (a PEG 20 C₁₆-C₁₈ alcohol from Heterene) and Ethomeen™ T/20 (a 10 EO tallowamine from Akzo Nobel), Hetoxol™ CS-20 and Ethomeen™ T/25 (a 15 EO tallowamine from Akzo Nobel), Hetoxol™ CS-25 (a PEG 25 C₁₆-C₁₈ alcohol from Heterene) and Ethomeen™ T/20, Hetoxol™ CS-25 and Ethomeen™ T/25, Brij™ 78 (a PEG 20 C₁₈ alcohol from Sigma Chemical Company) and Ethomeen™ T/20, Brij™ 78 and Ethomeen™ T/25, Brij™ 78 and Ethoquad™ T/20 (a PEG 10 tallow methyl ammonium chloride from Akzo Nobel), Brij™ 78 and Ethoquad™ T/25 (a PEG 15 tallow methyl ammonium chloride from Akzo Nobel), Plurafac™ A38 (a PEG 27 C₁₆-C₁₈ alcohol from Basf) and Ethomeen™ T/20, Plurafac™ A38 and Ethomeen™ T/25, Plurafac™ A38 and Ethoquad™ T/20, Plurafac™ A38 and Ethoquad™ T/25, ST 8303 (a PEG 14 C₁₆ alcohol from Cognis) and Ethoquad™ T/25, Arosurf™ 66 E10 (a PEG 10 isoC₁₈ alcohol from Witco/Crompton) and Ethoquad™ T/25, Arosurf™ 66 E20 (a PEG 20 isoC₁₈ alcohol from Witco/Crompton) and Ethoquad™ T/25, Arosurf™ 66 E20 and Ethomeen™ T/25, Hetoxol™ CS-20 and Ethomeen™ T/15 (a 5 EO tallowamine from Akzo Nobel), Hetoxol™ CS-20 and Ethomeen™ T/30 (a 20 EO tallowamine from Akzo Nobel), Hetoxol™ CS-20 and Ethomeen™ T/35 (a 25 EO tallowamine

from Akzo Nobel), Hetoxol™ CS-20 and Ethomeen™ T/40 (a 30 EO tallowamine from Akzo Nobel), Hetoxol™ CS-20 and Trymeen™ 6617 (a PEG 50 stearylamine from Cognis), Hetoxol™ CS-15 (a PEG 15 C₁₆-C₁₈ alcohol from Heterene) and Ethomeen™ T/25, Hetoxol™ CS-20 and a PEG 22 dimethyl quaternary ammonium chloride, Hetoxol™ CS-20 and lecithin, Hetoxol™ CS-25 and lecithin, Hetoxol™ CS-20 and Arquad™ C-50 (a dodecyl trimethyl ammonium chloride from Akzo Nobel), Hetoxol™ CS-20 and lauryl choline chloride, Hetoxol™ CS-15 and lauryl choline chloride, Procol™ LA 15 (a PEG 15 C₁₂ alcohol from Protameen) and Ethoquad™ T25, Hetoxol™ CS-20 and a PEG 7 dimethyl quaternary ammonium chloride, Hetoxol™ CS-20 and Gemini™ 10-2-10 (a C₁₀ ethylene N-methyl diamine from Monsanto), Hetoxol™ CS-20 and Gemini™ 10-3-10 (a C₁₀ propylene N-methyl diamine from Monsanto), Hetoxol™ CS-20 and Gemini™ 10-4-10 (a C₁₀ butylene N-methyl diamine from Monsanto), Hetoxol™ CS-20 and Gemini™ 14-2-14 (a C₁₄ ethylene N-methyl diamine from Monsanto), Hetoxol™ CS-20 and Gemini™ 14-3-14 (a C₁₄ propylene N-methyl diamine from Monsanto), palmitic acid and Ethomeen™ T/25, lecithin and Ethomeen™ T/25, lecithin and Ethoquad™ T/25, lecithin and Ethomeen™ T/20, lecithin and Ethoquad™ T/20, and lecithin and Fluorad™ FC 754 (a fluorinated alkyl quaternary ammonium chloride from 3M). Some of the above mixtures are synergistic, in that they are mixtures of surfactants which, when tested individually, did not form anisotropic aggregates.

The herbicidal formulations of the present invention including glyphosate and a surfactant that forms anisotropic aggregates on a waxy plant surface may be prepared as aqueous concentrated formulations comprising at least about 50 g glyphosate a.e./L, more preferably at least about 250 g glyphosate a.e./L, still more preferably at least about 300, 360, 380, 400, 440, 480, 500, 540, or 600 g glyphosate a.e./L. One example of a preferred aqueous concentrate glyphosate formulation contains the isopropylamine or potassium salt of glyphosate at about 360 g glyphosate a.e./L, or about the same level as currently used by Monsanto Corporation in its commercial formulation of Roundup® herbicide. Another preferred aqueous concentrate glyphosate formulation contains the isopropylamine or potassium salt of glyphosate at about 300 to about 600, preferably at about 400 to about 600, about 440 to about 600, about 440 to about 480, about 480 to about 600, or about 480 to about 540 g glyphosate a.e./L.

On a weight basis, stable aqueous concentrate compositions of the present invention including a surfactant that forms anisotropic aggregates on the cuticle

surface can be made with glyphosate at a concentration of at least about 35, 40, 41, 42, 43, 44, 45, 46, 47, 48, 49, or 50 % a.i. A concentration of about 35 to about 50% a.e., about 40 to about 50% a.i., about 45 to about 50% a.i., or more is preferred, particularly for potassium glyphosate.

In another embodiment, concentrated formulations which form anisotropic aggregates on the waxy surface of plants may be dry formulations which may be in the form of powders, pellets, tablets or granules. These dry formulations are typically dispersed or dissolved into water prior to use. Preferably, there are no substantially water insoluble constituents present at substantial levels in the such formulations such that the formulations are substantially water soluble. Dry water-soluble or water-dispersable formulations of the present invention typically comprise from about 20% to about 80% (by weight) glyphosate a.e., preferably from about 50% to about 80% (by weight) glyphosate a.e., and most preferably from about 60% to about 75% (by weight) glyphosate a.e.

In dry formulations of the present invention, the glyphosate itself may provide the support for other formulation constituents, or there may be additional inert ingredients which provides such support. One example of an inert support ingredient that may be used in accordance with the present invention is ammonium sulfate. It will be recognized by one skilled in the art that as used herein, the term "dry" does not imply that dry formulations of the present invention are 100% free of water. Typically, dry formulations of the present invention comprise from about 0.5% to about 5% (by weight) water. It is preferred that the dry formulations of the present invention contain less than about 1% (by weight) water.

Dry, water soluble or water dispersable formulations in accordance with the present invention can be produced by any process known in the art, including spray drying, fluid-bed agglomeration, pan granulation, or extrusion. In dry formulations, glyphosate may be present as a salt, or as an acid. Formulations containing glyphosate acid may optionally contain an acid acceptor such as an ammonium or alkali metal carbonate or bicarbonate, ammonium dihydrogen phosphate or the like so that upon dissolution or dispersion in water by the user a water soluble salt of glyphosate is produced.

Typically, herbicidal compositions of the present invention that are ready to be applied directly to foliage can be made with a glyphosate concentration of from about 1 to about 40 grams acid equivalent per liter, preferably from about 2 to about 18 grams acid equivalent per liter, more preferably from about 4 to about 11

grams acid equivalent per liter. One skilled in the art will recognize that various factors influence the application rate of glyphosate required for a desired result.

Any convenient and herbicidal activity enhancing amount of the surfactant which comprises anisotropic aggregates on the waxy surface of a plant may be used in the glyphosate formulations of the present invention. Preferably, the surfactant is present in the concentrated glyphosate formulations of the present invention in a concentration of from about 25 to about 250 g/L, more preferably from about 50 to about 200 g/L. Although higher concentrations of the surfactant can be incorporated into the glyphosate formulations of the present invention, for economical reasons it is generally more suitable to use the concentration ranges set forth above. Herbicidal formulations of the present invention that are ready to be applied directly to foliage can be made with a surfactant concentration of from about 0.1 g/L to about 10g/L, preferably from about 1 g/L to about 5 g/L.

In some herbicidal formulations of the present invention, the nature of the surfactant and the composition of the herbicidal formulation is such that upon application of the formulation to a plant or an application mixture prepared by dilution of the formulation with water, liquid crystals comprising the surfactant are formed on the foliage of the plant (epicuticular liquid crystals). In other words, liquid crystals comprising the surfactant form to create or enlarge hydrophilic channels through the epicuticular wax of the plant cuticle. An important feature of the herbicidal formulations of the present invention is that the surfactant be able to form liquid crystals in the presence of glyphosate on a waxy, porous substrate such as a leaf cuticle to produce transcuticular hydrophilic channels epicuticularly through the waxy cuticle. A distinguishing characteristic of the surfactants which comprise the liquid crystals in the presence of glyphosate is the tendency of the surfactant molecules to align themselves along a common axis in an ordered manner. Typically, liquid crystals have a higher degree of order than isotropic solutions and are much more fluid than solid crystals. Fluidity of liquid crystals may be an important factor in the improved translocation of glyphosate throughout the plant.

Many of the surfactants discussed herein which form liquid crystals on the cuticle surface in the presence of glyphosate to facilitate translocation of the glyphosate throughout the infrastructure of the plant do not form liquid crystals in the concentrated glyphosate solutions at concentrations typically found to be commercially viable. Typically, these surfactants form liquid crystals in the dried down glyphosate/surfactant deposit that forms from drops or spraying of the

diluted formulation onto the plant cuticle surface. Generally, and without being bound to a particular theory, it appears that the formation of liquid crystals in the concentrated glyphosate solution itself is not necessarily important or related (although in some circumstances it may be helpful) to the formation of liquid crystals on and in the plant surface. Typically, it is more important that liquid crystals comprised of the surfactant form as a dry-down deposit on the leaf surface. However, in some formulations liquid crystals may form in the concentrated glyphosate/surfactant solutions and on and in the leaf, but not in the diluted spray mixture.

As previously mentioned, the formation of liquid crystals epicuticularly may result from the drying down of glyphosate and surfactant containing droplets applied to the plant. Several environmental factors including air temperature, humidity, and wind speed may affect how quickly liquid crystals form in and on the plant. In some situations, the liquid crystals may actually be formed by phase separation from the main droplet on the foliage. Although the surfactants listed herein form liquid crystals in the presence of glyphosate, it is believed that it is preferable for surfactant molecules to have a molecular weight of less than about 2500. When the molecular weight of the surfactant is in excess of 2500, liquid crystals may still form but not be quite as effective and efficient in the translocation of glyphosate as lower molecular weight surfactants.

The liquid crystals comprising a surfactant in the presence of glyphosate epicuticularly are typically lyotropic liquid crystals; that is the formation of liquid crystals is typically induced by the presence of a solvent, in this case water. The mesophases of the liquid crystals depend not only on the solvent present, but also on temperature. Lyotropic liquid crystals comprising a surfactant in the presence of glyphosate that form transcuticular hydrophilic channels have been observed in hexagonal formation, reversed hexagonal formation, and lamellar and multilamellar formations having at least about 20 to about 30 or more separate, distinct layers. It may be possible to also have lyotropic liquid crystals in a cubical form. Also, both smectic and nematic forms of liquid crystals comprised of a surfactant in the presence of glyphosate have been observed. In the herbicidal formulations of the present invention, liquid crystals form regardless of the presence or absence of a second surfactant.

Further, some surfactants in the presence of glyphosate may form wormlike micelles, another class of organized structures in liquid form which may facilitate the translocation of glyphosate through the waxy cuticle and into the

plant. Wormlike micelles are typically less organized than liquid crystals but still have sufficient organization to form hydrophilic channels on and in the plant to facilitate the translocation of glyphosate through the plant. Typically, surfactants that are sufficiently "flexible" will form these types of wormlike micelles.

To determine the onset concentration of glyphosate and surfactants in dry down deposits that are liquid crystal in nature, the following testing procedure may be utilized. The experiments are conducted under 50% relative humidity and 24° C. The isolated cuticles are prepared according to the protocol described herein. A liquid crystal forming glyphosate formulation, which contains a certain amount of glyphosate salts (e.g. potassium), a liquid crystal forming surfactant (e.g. C₁₆₋₁₈ ether EO 15 dimethyl propylamine), are placed on pre-prepared isolated leaf cuticles as 1 microliter droplets and observed under a polarized microscope for the on-set of birefringence. In a separate experiment, those droplets that show birefringence are examined and confirmed to show characteristic liquid crystal patterns.

Once the onset of birefringence is observed, the droplets are scraped from the cuticle as quickly as possible, dissolved in 1 ml of 99.9% (nominal) D₂O and transferred into a 5 mm NMR tube. The spectra can be acquired using a Varian Unity Inova 400 MHz spectrometer equipped with a 5 mm Nalorac pulse tune probe. For example, a 30 degree pulse may be used to acquire scans with an appropriate recycle time. The determination may be made by the integration of the glyphosate doublet signal and the water signal.

The concentration of the glyphosate in these droplets has been determined to be 37% (+/- 6%) according to this method. However, it is noted that the evaporation of the water from the drying down droplets is relatively fast (in minutes). Therefore, results may vary from 37% to 50% w/wt. depending upon the skill of the technician performing the task of transferring from the cuticle to the NMR tube.

To determine whether a herbicidal formulation comprising glyphosate or a salt or ester thereof and a surfactant forms liquid crystals comprising the surfactant on the foliage of a plant, the following high resolution polarized microscopy birefringence testing procedure may be utilized. This high resolution birefringence test is capable of distinguishing liquid crystal phase formations and their characteristic microfine textures from other types of anisotropic aggregates or solid crystals precipitated out of solution due to water evaporation. The test procedure is as follows.

Prior to testing for birefringence, a cuticle from greenhouse grown velvetleaf (*Abutilon theophrasti*) is isolated for testing. Other suitable plants that can be used to supply a test cuticle include prickly sida, giant ragweed, and morningglory. To isolate the cuticle, stock solutions of glacial acetic acid and sodium acetate are prepared. The glacial acetic acid stock solution has a concentration of between about 1 to about 5% (weight/weight), and the sodium acetate stock solution has a concentration of between about 1 and about 5% (weight/weight). The stock solutions are mixed together to form a buffered solution having a pH of from about 4.2 to about 4.6.

After the buffer solution is prepared, an enzyme solution is prepared. Typically, the enzyme solution will be prepared at or very near the time of cuticle isolation for maximum effectiveness. The enzyme solution is prepared by adding about 1 to about 5% (weight/weight) and about 0.1 to about 0.5% (weight/weight) cellulase in water. Typically, the pectinase has an activity of 3600 units/gram and cellulase has an activity of about 10,600 units/gram. The enzyme solution is then sterile infiltrated and ready for use or storage.

A healthy leaf from the source plant is removed and its backside is abraded with fine sea sand. The leaf is then thoroughly rinsed with the buffer solution as prepared above and a healthy section of the leaf is cut out for cuticle isolation. The cut portion of the leaf is infiltrated with the freshly prepared enzyme solution and held at a temperature of from about 30°C to about 35°C for about 1 hour or until the leaf cuticle detaches from the leaf tissue substrate. After detachment, the cuticle is carefully removed from the buffered solution and thoroughly rinsed with deionized water and stored in a buffer solution having a pH of about 4 to 6 in an area having a humidity of about 30% to about 75% and a temperature of about 20 to about 30°C until use. Typically, the cuticle is stored in the controlled environment for at least about 24 hours to allow it to reach equilibrium with its environment.

After a cuticle has been isolated, it is used for the test to determine whether a specific herbicidal formulation containing glyphosate and a surfactant forms liquid crystals comprising the surfactant on the waxy cuticle. The cuticle is transferred to a glass slide and examined under a microscope (without any polarized light) for cracks and other damage. If cracks or other damage are identified on the surface of the cuticle, it is discarded. Once a suitable cuticle is observed, it is further examined under a microscope (at 7.5 x magnification) with polarized light to ensure that a dark field is observed. If small areas of crystalline

64725-903 (D)

93

wax are noted on the cuticle surface, these areas are carefully avoided during testing.

After observing the cuticle for defects, the glass slide is connected to a heating/cooling circuit which is capable of regulating the temperature of the glass plate during testing. Heat is applied to the glass plate and the cuticle is allowed to reach equilibrium with the temperature of the glass plate 15°C to about 35°C. After equilibrium is reached, a sample of the test solution is prepared. The sample may either be in diluted or concentrated form, although it is preferred that the sample be in a diluted form such that the glyphosate concentration (a.e.) is in the range of about 1 % to about 10% (weight/weight) in the test sample and the glyphosate to surfactant ratio is in the range of about 1 to 1 to about 10:1 (weight/weight), preferably about 3:1 (weight/weight). A drop of the aqueous test sample is placed on the cuticle and observed under polarized light (7.5 x magnification) transmitted through the cuticle. Images of the sample droplets on the cuticle are recorded and stored in a computer connected to a video monitor using Flash Point 128 Software at a present time interval. The images are then digitized using Image Pro by Media Cybernetics.

In each test, sample droplets are duplicated onto two nearly identical cuticles. If birefringence is observed under the polarized microscope at 7.5 x magnification, the sample is transferred immediately to a polarized microscope having magnification capabilities of 100 x magnification to 400 x magnification. With this microscope, at 200 x magnification, characteristic liquid crystal patterns can be seen and distinguished from solid crystals or other birefringent materials. If liquid crystals are observed under the high power magnification, the sample formulation forms epicuticular liquid crystals on the foliage of the plant.

Herbicidal formulations of the present invention containing glyphosate or a salt or ester thereof form epicuticular liquid crystals have substantially improved performance over herbicidal formulations currently available, and may be superior to herbicidal formulations which simply form anisotropic aggregates epicuticularly. Without being bound to a particular theory, it appears that the formation of liquid crystals on the epicuticular portion of a plant form or enlarge hydrophilic channels through the waxy cover of foliage. These created or enlarged hydrophilic channels may substantially increase the mass transfer of glyphosate through the waxy cuticle and into the plant.

64725-903 (D)

94

Surfactants that are effective in forming epicuticular liquid crystals in the presence of glyphosate include nonionic, cationic, and amphoteric surfactants and mixtures thereof.

Mixtures of surfactants as described above are also effective in forming epicuticular liquid crystals. Preferred mixtures include an alkoxyated alcohol nonionic surfactant and a dialkoxyated quaternary ammonium, monoalkoxyated quaternary ammonium, or dialkoxyated amine cationic surfactant. Other preferred mixtures contain a phospholipid amphoteric surfactant and an alkoxyated alcohol nonionic surfactant. Examples of such preferred mixtures include Hetoxol™ CS-20 (a PEG 20 C₁₆-C₁₈ alcohol from Heterene) and Ethomeen™ T/20 (a 10 EO tallowamine from Akzo Nobel), Hetoxol™ CS-20 and Ethomeen™ T/25 (a 15 EO tallowamine from Akzo Nobel), Hetoxol™ CS-25 (a PEG 25 C₁₆-C₁₈ alcohol from Heterene) and Ethomeen™ T/20, Hetoxol™ CS-25 and Ethomeen™ T/25, Brij™ 78 (a PEG 20 C₁₈ alcohol from Sigma Chemical Company) and Ethomeen™ T/20, Brij™ 78 and Ethomeen™ T/25, Brij™ 78 and Ethoquad™ T/20 (a PEG 10 tallow methyl ammonium chloride from Akzo Nobel), Brij™ 78 and Ethoquad™ T/25 (a PEG 15 tallow methyl ammonium chloride from Akzo Nobel), Plurafac™ A38 (a PEG 27 C₁₆-C₁₈ alcohol from Basf) and Ethomeen™ T/20, Plurafac™ A38 and Ethomeen™ T/25, Plurafac™ A38 and Ethoquad™ T/20, Plurafac™ A38 and Ethoquad™ T/25, ST 8303 (a PEG 14 C₁₆ alcohol from Cognis) and Ethoquad™ T/25, Arosurf™ 66 E10 (a PEG 10 isoC₁₈ alcohol from Witco/Crompton) and Ethoquad™ T/25, Arosurf™ 66 E20 (a PEG 20 isoC₁₈ alcohol from Witco/Crompton) and Ethoquad™ T/25, Arosurf™ 66 E20 and Ethomeen™ T/25, Hetoxol™ CS-20 and Ethomeen™ T/15 (a 5 EO tallowamine from Akzo Nobel), Hetoxol™ CS-20 and Ethomeen™ T/30 (a 20 EO tallowamine from Akzo Nobel), Hetoxol™ CS-20 and Ethomeen™ T/35 (a 25 EO tallowamine from Akzo Nobel), Hetoxol™ CS-20 and Ethomeen™ T/40 (a 30 EO tallowamine from Akzo Nobel), Hetoxol™ CS-20 and Trymeen™ 6617 (a PEG 50 stearylamine from Cognis), Hetoxol™ CS-15 (a PEG 15 C₁₆-C₁₈ alcohol from Heterene) and Ethomeen™ T/25, Hetoxol™ CS-20 and a PEG 22 dimethyl quaternary ammonium chloride, Hetoxol™ CS-20 and lecithin, and Hetoxol™ CS-25 and lecithin. Some of the above mixtures are synergistic, in that they are mixtures of surfactants which, when tested individually, did not form anisotropic aggregates and/or epicuticular liquid crystals.

In some herbicidal formulations of the present invention, the nature of the surfactant and the composition of the herbicidal formulation is such that upon

application of the formulation to a plant or an application mixture prepared by dilution of the formulation with water, liquid crystals comprising the surfactant are formed both on the foliage of the plant (epicuticular liquid crystals) and in the foliage of the plant (intracuticular liquid crystals). In other words, liquid crystals comprising the surfactant form to create or enlarge hydrophilic channels through the epicuticular wax of the plant cuticle and also form inside of the plant (intracuticular) to form pathways deep inside of the plant which may significantly enhance translocation of glyphosate throughout the plant pathways. These transcuticular pathways may be responsible for the increase efficacy such formulations provide. An important feature of the herbicidal formulations of the present invention which form both epicuticular and intracuticular liquid crystals is that the surfactant is able to form liquid crystals both on and in the plant.

Many of the surfactants discussed herein which form liquid crystals on the cuticle surface and within the plant in the presence of glyphosate to facilitate translocation of glyphosate throughout the infrastructure of the plant may not form liquid crystals in the concentrate glyphosate solutions at concentrations typically found to be commercially viable. Typically, these surfactants form liquid crystals in the dried down glyphosate/surfactant deposit that forms from drops or spraying of the diluted formulation onto the plant cuticle surface. Generally, and without being bound to a particular theory, it appears that the formation of liquid crystals in the concentrated glyphosate solution itself is not necessarily important or related (although in some circumstance it may be helpful) to the formation of liquid crystals on and in the plant surface. Typically, it is more important that liquid crystals comprised of the surfactant form as a dry-down deposit on the leaf surface. However, in some formulations liquid crystals may form in the concentrated glyphosate/surfactant solutions and on and in the leaf, but not in the diluted spray mixture.

As previously mentioned, the formation of liquid crystals epicuticularly and intracuticularly may result from the drying down of glyphosate and surfactant containing droplets applied to the plant. Several environmental factors including air temperature, humidity, and wind speed may affect how quickly liquid crystals form in and on the plant. In some situations, the liquid crystals may actually be formed by phase separation from the main droplet. Although the surfactants listed herein form liquid crystals in the presence of glyphosate, it is believed that it is preferable for surfactant molecules to have a molecular weight of less than about 2500. When the molecular weight of the surfactant is in excess of about

2500, liquid crystals may still form in and on the plant, but may not be as effective and efficient in the translocation of glyphosate as lower molecular weight surfactants.

The liquid crystals comprising a surfactant in the presence of glyphosate epicuticularly and intracuticularly are typically lyotropic liquid crystals; that is the formation of liquid crystals is typically induced by the presence of a solvent, such as water. The mesophases of the liquid crystals depend not only on the solvent, but may also be temperature dependent. Lyotropic liquid crystals comprising a surfactant in the presence of glyphosate epicuticularly and intracuticularly have been observed in cubical formation, hexagonal formation, reversed hexagonal formation, and lamellar and multilamellar formations having at least about 20 to about 30 or more separate layers. Also, both smectic and nematic forms of liquid crystals comprised of a surfactant in the presence of glyphosate have been observed both epicuticularly and intracuticularly. In the herbicidal formulations of the present invention, both epicuticular and intracuticular liquid crystals comprising a surfactant in the presence of glyphosate form regardless of the presence or absence of a second surfactant.

In some formulations of the present invention comprising glyphosate and a surfactant which forms epicuticular and intracuticular liquid crystals the liquid crystals comprise a stratified array of the surfactant molecules such that the hydrophilic moieties of the surfactant molecules in one stratum of the stratified array is oriented toward the hydrophilic moieties of the surfactant molecules in a second stratum of the stratified array. The liquid crystals of the present invention, both epicuticular and intracuticular, may form this type of stratified array and may have numerous layers as discussed above.

In some formulations of the present invention comprising glyphosate and a surfactant which forms epicuticular and intracuticular liquid crystals the liquid crystals may orient themselves in a stratified array such that lipophilic moieties of the surfactant molecules of one stratum of the stratified array are in contact with a hydrophobic surface on the foliage of a plant that the formulation is applied to. Further, the surfactant molecules of one stratum of the stratified array may be in contact with a hydrophobic surface located within a cuticle of a plant that the formulation is applied to.

Further, some surfactants in the presence of glyphosate may form wormlike micelles, another class of organized structures in liquid form which may facilitate the translocation of glyphosate through the waxy cuticle and into and

throughout the plant, both epicuticularly and intracuticularly. Wormlike micelles are typically less organized than liquid crystals but may still have sufficient organization to form hydrophilic channels on and in the plant to facilitate the introduction and translocation of glyphosate in and throughout the plant. Typically, surfactants that are sufficiently "flexible" will form these types of wormlike micelles.

Although the present invention is directed primarily at aqueous concentrate formulations of the potassium salt of glyphosate, such aqueous concentrate formulations can optionally further comprise one or more additional pesticides, such as for example, water-soluble herbicidal active ingredients, including without restriction water-soluble forms of acifluorfen, asulam, benazolin, bentazon, bialaphos, bispyribac, bromacil, bromoxynil, carfentrazone, chloramben, clopyralid, 2,4-D, 2,4-DB, dalapon, dicamba, dichlorprop, diclofop, difenzoquat, diquat, endothall, fenac, fenoxaprop, flamprop, fluazifop, fluoroglycofen, fluroxypyr, fomesafen, fosamine, glufosinate, haloxyfop, imazameth, imazamethabenz, imazamox, imazapic, imazapyr, imazaquin, imazethapyr, ioxynil, MCPA, MCPB, mecoprop, methylarsonic acid, naptalam, nonanoic acid, paraquat, picloram, sulfamic acid, 2,3,6-TBA, TCA and triclopyr.

An embodiment of the invention therefore is an herbicidal aqueous concentrate composition comprising glyphosate predominantly in the form of the potassium salt thereof, and a second anionic herbicide predominantly in the form of a potassium or other agriculturally acceptable salt or acid thereof, the total concentration of the glyphosate and the second anionic herbicide together being about 360 to about 570 g a.e./l, the composition further comprising a surfactant component, selected in accordance with the invention, at a concentration of about 20 to about 300 g/l.

In this embodiment, it is preferred that the weight/weight ratio of glyphosate a.e. to the second anionic herbicide be not less than about 1:1, for example from about 1:1 to about 200:1, preferably between 1:1 to about 30:1. The second anionic herbicide is preferably selected from the group consisting of acifluorfen, bialaphos, carfentrazone, clopyralid, 2,4-D, 2,4-DB, dicamba, dichlorprop, glufosinate, MCPA, MCPB, mecoprop, methylarsonic acid, nonanoic acid, picloram, triclopyr and herbicides of the imidazolinone class, including imazameth, imazamethabenz, imazamox, imazapic, imazapyr, imazaquin and imazethapyr.

Also embraced by the present invention are liquid concentrate formulations having an aqueous phase wherein glyphosate is present predominantly in the

form of the potassium salt thereof, and a non-aqueous phase optionally containing a second herbicidal active ingredient that is relatively water-insoluble. Such formulations illustratively include emulsions (including macro- and microemulsions, water-in-oil, oil-in-water and water-in-oil-in-water types), suspensions and suspoemulsions. The non-aqueous phase can optionally comprise a microencapsulated component, for example a microencapsulated herbicide. In formulations of the invention having a non-aqueous phase, the concentration of glyphosate a.e. in the composition as a whole is nonetheless within the ranges recited herein for aqueous concentrate formulations.

Illustrative water-insoluble herbicides that can be used in such formulations include acetochlor, aclonifen, alachlor, ametryn, amidosulfuron, anilofos, atrazine, azafenidin, azimsulfuron, benfluralin, benfuresate, bensulfuron-methyl, bensulide, benzofenap, bifenox, bromobutide, bromofenoxim, butachlor, butamifos, butralin, butroxydim, butylate, cafenstrole, carbetamide, carfentrazone-ethyl, chlomethoxyfen, chlorbromuron, chloridazon, chlorimuron-ethyl, chlornitrofen, chlorotoluron, chlorpropham, chloresulfuron, chlorthal-dimethyl, chlorthiamid, cinmethylin, cinosulfuron, clethodim, clodinafop-propargyl, clomazone, clomeprop, cloransulam-methyl, cyanazine, cycloate, cyclosulfamuron, cycloxydim, cyhalofop-butyl, daimuron, desmedipham, desmetryn, dichlobenil, diclofop-methyl, diflufenican, dimefuron, dimepiperate, dimethachlor, dimethametryn, dimethenamid, dinitramine, dinoterb, diphenamid, dithiopyr, diuron, EPTC, esprocarb, ethalfluralin, ethametsulfuron-methyl, ethofumesate, ethoxysulfuron, etobenzanid, fenoxaprop-ethyl, fenuron, flamprop-methyl, flazasulfuron, fluazifop-butyl, fluchloralin, flumetsulam, flumiclorac-pentyl, flumioxazin, fluometuron, fluorochloridone, fluoroglycofen-ethyl, flupoxam, flurenol, fluridone, fluroxypyr-1-methylheptyl, flurtamone, fluthiacet-methyl, fomesafen, halosulfuron, haloxyfop-methyl, hexazinone, imazosulfuron, indanofan, isoproturon, isouron, isoxaben, isoxaflutole, isoxapyrifop, lactofen, lenacil, linuron, mefenacet, metamidron, metazachlor, methabenzthiazuron, methyldymron, metobenzuron, metobromuron, metolachlor, metosulam, metoxuron, metribuzin, metsulfuron, molinate, monolinuron, naproanilide, napropamide, naptalam, neburon, nicosulfuron, norflurazon, orbencarb, oryzalin, oxadiargyl, oxadiazon, oxasulfuron, oxyfluorfen, pebulate, pendimethalin, pentanochlor, pentoxazone, phenmedipham, piperophos, pretilachlor, primisulfuron, prodiamine, prometon, prometryn, propachlor, propanil, propaquizafop, propazine, propham, propisochlor, propyzamide, prosulfocarb, prosulfuron, pyraflufen-ethyl, pyrazolynate,

pyrazosulfuron-ethyl, pyrazoxyfen, pyributicarb, pyridate, pyriminobac-methyl, quinclorac, quinmerac, quizalofop-ethyl, rimsulfuron, sethoxydim, siduron, simazine, simetryn, sulcotrione, sulfentrazone, sulfometuron, sulfosulfuron, tebutam, tebuthiuron, terbacil, terbumeton, terbuthylazine, terbutryn, thenylchlor, thiazopyr, thifensulfuron, thiobencarb, tiocarbazil, tralkoxydim, triallate, triasulfuron, tribenuron, trietazine, trifluralin, triflusulfuron and vernolate. It is preferred that the weight/weight ratio of glyphosate a.e. to such water-insoluble herbicide be not less than 1:1, for example from about 1:1 to about 200:1, preferably between 1:1 to about 30:1.

Excipient ingredients other than the above-defined surfactant component can optionally be present in a composition of the invention, so long as the cloud point and non-crystallization properties of the composition remain in accordance with the invention. Such additional excipient ingredients include conventional formulation additives such as dyes, thickeners, crystallization inhibitors, antifreeze agents including glycols, foam moderating agents, antidrift agents, compatibilizing agents, etc.

A type of excipient ingredient often used in glyphosate formulations is an inorganic salt such as ammonium sulfate, included to enhance herbicidal activity, or consistency of herbicidal activity, of the glyphosate. As the content of inorganic salt in the formulation needed to provide such enhancement is typically relatively high, often greater than the amount of glyphosate present, it will seldom be useful to add such salt to a composition of the invention. The amount of ammonium sulfate, for example, that could be accommodated in a storage-stable aqueous composition containing glyphosate potassium salt at a concentration of at least 360 g a.e./l would be so small as to bring no substantial benefit. An alternative, therefore, is to include a small amount of a synergist such as an anthraquinone compound or a phenyl-substituted olefin compound as disclosed in International Publication Nos. WO 98/33384 and WO 98/33385 respectively.

To determine whether a herbicidal formulation comprising glyphosate or a salt or ester thereof and a surfactant forms liquid crystals comprising a surfactant on the foliage of a plant and in the foliage of a plant, the following procedures are utilized. First, the surfactant/glyphosate formulation is tested as described above to determine whether liquid crystals form epicuticularly on the plant foliage. If it is determined that epicuticular liquid crystals do form on the plant foliage, the following testing procedure using high resolution polarized microscopy is utilized to determine whether liquid crystals also form intracuticularly.

In determining whether intracuticular liquid crystals form, fruit cuticles such as pear cuticles or tomato cuticles are typically used because they are highly robust. The isolation of the fruit cuticle is performed similarly to that of a broadleaf cuticle described above with certain modifications. Typically, the enzyme utilized to remove the fruit cuticle is pectinase (10,000 activity units per 100 mL). The concentration of the enzyme solution is typically from about 10% to about 30% weight/weight and the final enzyme solution typically contains activity of about 50 to about 200 units/mL. The fruit cuticle is incubated with the enzyme at room temperature for a period of about 1 hour or more to detach the fruit cuticle. After detachment of the cuticle, it is thoroughly rinsed and washed prior to use.

To determine whether intracuticular liquid crystals form with a surfactant/glyphosate formulation, a fruit cuticle as described above is used along side a control system in which the substrate is a non-porous hydrophobic material such as parafilm. The fruit cuticle is positioned on a supporting gel agar which rests on a supporting mesh, typically comprised of carbon fibers. The cuticle/agar/mesh composition is then placed on a glass slide. The parafilm is also mounted on the glass slide in this manner.

Herbicidal formulations of interest containing a surfactant and glyphosate are deposited on the cuticle and on the parafilm. When the onset of liquid crystal formation is observed under a polarized light at 100 x magnification as described above, both the cuticle and the parafilm control are wiped away either by hand or by mechanical means with a foam tip at room temperature. Typically, the liquid crystals formed on the parafilm are easily wiped away. Both the parafilm control and the fruit cuticle, after wiping, are left to achieve equilibrium for between about 24 and about 48 hours in a controlled environment (temperature between 20 to about 25°C, humidity 50% to 75%)

After equilibrium has been achieved with the parafilm control and the fruit cuticle, the area where the formulation deposits were made are again rigorously wiped by hand or mechanically with a foam tip. After wiping, the cuticle and parafilm are again examined under 100 x magnification polarized light for liquid crystal formation. If the microfine texture is observed after the second wiping procedure, this is an indication of intracuticular liquid crystal formation as these liquid crystals have not been removed after two wiping cycles. Further, additional wiping may be conducted on the fruit cuticles showing liquid crystal formation to further evidence that the liquid crystals cannot be wiped off as they are

intracuticular. After the second wiping, the inventors have not seen any formation of liquid crystals on any of the parafilm controls observed.

Typically, only a very small amount of solubilizer will be required to impart improved formulation characteristics. Generally, only a ratio of about 50:1 (by weight), more preferably about 25:1, still more preferably about 10:1, and most preferably about 8:1 ethoxylated etheramine surfactant to solubilizer is required. One skilled in the art will recognize that various factors may influence the amount of solubilizer required to impart the desired characteristics. The solubilizer may also be included in the formulation at a lower ratio at which it may not function as a solubilizer but will enhance efficacy, such as a surfactant to solubilizer ratio of about 5:1, about 4:1, about 3:1, about 2:1 or about 1:1.

Further, the addition of a solubilizer imparts improved viscosity characteristics on concentrated formulations of the present invention. It is preferred that sufficient solubilizer be added to the formulation to produce a formulation having a viscosity of less than 1000 c.p. at 0°C at 45/s shear rate, even more preferably less than about 500 c.p. at 0°C at 45/s shear rate, and most preferably less than about 300 c.p. at 0°C at 45/s shear rate. In a preferred embodiment, the herbicidal formulations of the present invention have a viscosity of from about 100 c.p. at 0°C at 45/s shear rate to about 500 c.p. at 0°C at 45/s shear rate. The novel formulations of the present invention require only a small amount of solubilizer to produce these desired viscosities.

Another ingredient that can optionally be added to the glyphosate herbicidal formulations of the present invention to further improve the herbicidal effectiveness and related herbicidal properties is a di-carboxylic acid or salt of a di-carboxylic acid. Suitable di-carboxylic acids that may be added to the herbicidal formulations comprising glyphosate or a salt or ester thereof and a surfactant as described herein include, for example, oxalic acid, malonic acid, succinic acid, glutaric acid, maleic acid, adipic acid, and fumaric acid, and combinations or mixtures thereof, with oxalic acid being preferred. Also, in addition to, or in place of the di-carboxylic acid, salts of the aforementioned di-carboxylic acids may be incorporated into the herbicidal formulations of the present invention to improve herbicidal performance. Suitable salts include, for example, alkali metal salts such as potassium salts, alkanolamine salts and lower alkylamine salts. Preferred salts include potassium oxalate, dipotassium oxalate, sodium oxalate, disodium oxalate, diammonium oxalate, diethanolamine oxalate,

dimethylamine oxalate, alkanolamine salts of oxalic acid, and lower alkylamine salts of oxalic acid.

Formulations containing a di-carboxylic acid such as oxalic acid or a di-carboxylic acid salt such as potassium oxalate, typically contain a sufficient amount of di-carboxylic acid/di-carboxylic acid salt to enhance the resulting efficacy of the herbicidal formulation. Typically, the weight ratio of total surfactant to carboxylic acid/carboxylic acid salt may be from about 1:1 to about 50:1, more preferably 5:1 to 40:1 and most preferably from about 5:1 to about 20:1. This ratio of total surfactant to carboxylic acid/carboxylic acid salt significantly enhances the herbicidal performance of the resulting herbicidal formulation.

The di-carboxylic acid or salt thereof which can be added to herbicidal formulations of the present invention to improve efficacy are suitable for use with glyphosate, or salts or esters thereof. Suitable glyphosate salts include those listed above, specifically isopropylamine salt, potassium salt, and trimethylammonium salt.

The present invention also includes a method for killing or controlling weeds or unwanted vegetation comprising the steps of diluting a liquid concentrate in a convenient amount of water to form a tank mix and applying a herbicidally effective amount of the tank mix to the foliage of the weeds or unwanted vegetation. Similarly included in the invention is the method of killing or controlling weeds or unwanted vegetation comprising the steps of diluting a solid particulate concentrate in a convenient amount of water to form a tank mix and applying a herbicidally effective amount of the tank mix to the foliage of the weeds or unwanted vegetation.

In a herbicidal method of using a composition of the invention, the composition is diluted in a suitable volume of water to provide an application solution which is then applied to foliage of a plant or plants at an application rate sufficient to give a desired herbicidal effect. This application rate is usually expressed as amount of glyphosate per unit area treated, e.g., grams acid equivalent per hectare (g a.e./ha). What constitutes a "desired herbicidal effect" is, typically and illustratively, at least 85% control of a plant species as measured by growth reduction or mortality after a period of time during which the glyphosate exerts its full herbicidal or phytotoxic effects in treated plants. Depending on plant species and growing conditions, that period of time can be as short as a week, but normally a period of at least two weeks is needed for glyphosate to exert its full effect.

The selection of application rates that are herbicidally effective for a composition of the invention is within the skill of the ordinary agricultural scientist. Those of skill in the art will likewise recognize that individual plant conditions, weather and growing conditions, as well as the specific active ingredients and their weight ratio in the composition, will influence the degree of herbicidal effectiveness achieved in practicing this invention. With respect to the use of glyphosate compositions, much information is known about appropriate application rates. Over two decades of glyphosate use and published studies relating to such use have provided abundant information from which a weed control practitioner can select glyphosate application rates that are herbicidally effective on particular species at particular growth stages in particular environmental conditions.

Herbicidal compositions of glyphosate salts are used to control a very wide variety of plants worldwide, and it is believed the potassium salt will prove no different from other salts of glyphosate in this regard.

Particularly important annual dicotyledonous plant species for control of which a composition of the invention can be used are exemplified without limitation by velvetleaf (*Abutilon theophrasti*), pigweed (*Amaranthus spp.*), buttonweed (*Borreria spp.*), oilseed rape, canola, indian mustard, etc. (*Brassica spp.*), commelina (*Commelina spp.*), filaree (*Erodium spp.*), sunflower (*Helianthus spp.*), morningglory (*Ipomoea spp.*), kochia (*Kochia scoparia*), mallow (*Malva spp.*), wild buckwheat, smartweed, etc. (*Polygonum spp.*), purslane (*Portulaca spp.*), russian thistle (*Salsola spp.*), sida (*Sida spp.*), wild mustard (*Sinapis arvensis*) and cocklebur (*Xanthium spp.*).

Particularly important annual monocotyledonous plant species for control of which a composition of the invention can be used are exemplified without limitation by wild oat (*Avena fatua*), carpetgrass (*Axonopus spp.*), downy brome (*Bromus tectorum*), crabgrass (*Digitaria spp.*), barnyardgrass (*Echinochloa crus-galli*), goosegrass (*Eleusine indica*), annual ryegrass (*Lolium multiflorum*), rice (*Oryza sativa*), ottochloa (*Ottochloa nodosa*), bahiagrass (*Paspalum notatum*), canarygrass (*Phalaris spp.*), foxtail (*Setaria spp.*), wheat (*Triticum aestivum*) and corn (*Zea mays*).

Particularly important perennial dicotyledonous plant species for control of which a composition of the invention can be used are exemplified without limitation by mugwort (*Artemisia spp.*), milkweed (*Asclepias spp.*), canada thistle

(*Cirsium arvense*), field bindweed (*Convolvulus arvensis*) and kudzu (*Pueraria spp.*).

Particularly important perennial monocotyledonous plant species for control of which a composition of the invention can be used are exemplified without limitation by brachiaria (*Brachiaria spp.*), bermudagrass (*Cynodon dactylon*), yellow nutsedge (*Cyperus esculentus*), purple nutsedge (*C. rotundus*), quackgrass (*Elymus repens*), lalang (*Imperata cylindrica*), perennial ryegrass (*Lolium perenne*), guineagrass (*Panicum maximum*), dallisgrass (*Paspalum dilatatum*), reed (*Phragmites spp.*), johnsongrass (*Sorghum halepense*) and cattail (*Typha spp.*).

Other particularly important perennial plant species for control of which a composition of the invention can be used are exemplified without limitation by horsetail (*Equisetum spp.*), bracken (*Pteridium aquilinum*), blackberry (*Rubus spp.*) and gorse (*Ulex europaeus*).

If desired, the user can mix one or more adjuvants with a composition of the invention and the water of dilution when preparing the application composition. Such adjuvants can include additional surfactant and/or an inorganic salt such as ammonium sulfate with the aim of further enhancing herbicidal efficacy. However, under most conditions a herbicidal method of use of the present invention gives acceptable efficacy in the absence of such adjuvants.

In a particular contemplated method of use of a composition of the invention, the composition, following dilution in water, is applied to foliage of crop plants genetically transformed or selected to tolerate glyphosate, and simultaneously to foliage of weeds or undesired plants growing in close proximity to such crop plants. This method of use results in control of the weeds or undesired plants while leaving the crop plants substantially unharmed. Crop plants genetically transformed or selected to tolerate glyphosate include those whose seeds are sold by Monsanto Company or under license from Monsanto Company bearing the Roundup Ready® trademark. These include, without restriction, varieties of cotton, soybean, canola, sugar beet, wheat and corn.

Plant treatment compositions can be prepared simply by diluting a concentrate composition of the invention in water. Application of plant treatment compositions to foliage is preferably accomplished by spraying, using any conventional means for spraying liquids, such as spray nozzles, atomizers or the like. Compositions of the invention can be used in precision farming techniques, in which apparatus is employed to vary the amount of pesticide applied to

different parts of a field, depending on variables such as the particular plant species present, soil composition, etc. In one embodiment of such techniques, a global positioning system operated with the spraying apparatus can be used to apply the desired amount of the composition to different parts of a field.

A plant treatment composition is preferably dilute enough to be readily sprayed using standard agricultural spray equipment. Useful spray volumes for the present invention can range from about 10 to about 1000 liters per hectare (l/ha) or higher, by spray application.

EXAMPLES

The following Examples are provided for illustrative purposes only and are not intended to limit the scope of the present invention. The Examples will permit better understanding of the invention and perception of its advantages and certain variations of execution.

Example A Preparation of Glyphosate Potassium Salt

To a glass container of approximately 4 liter capacity was added 1264.1 grams of glyphosate acid with an assay of 95.7%. The container was placed in an ice/water bath to provide cooling. The container was equipped with an overhead stirrer with a propeller blade approximately one half the diameter of the container. A commercial 45% potassium hydroxide solution (VWR Scientific Products) was added. The addition rate was controlled to avoid obvious boiling of the resulting solution. The stirrer height was adjusted as the volume of the liquid changed to insure good mixing. A total of 966.2 grams of potassium hydroxide solution were added. The concentration was adjusted by the addition of 195.3 grams of deionized water. Stirring was continued for approximately 1 hour. The final yield was 2418.4 grams which represents a weight loss of 7.2 grams. The calculated assay was 50.0% glyphosate acid or 61% of potassium glyphosate and the calculated neutralization was 108%. The pH of a 10% dilution in deionized water was 4.76. The density of the resulting solution at 20°C was approximately 1.4661 grams/milliliter and the volume of 1000 grams at 20°C was therefore approximately 682 ml. This corresponds to a weight/volume concentration of about 730 grams/liter.

Example B Preparation of Comparative Formulations and Formulations of the Present Invention

Surfactant-containing compositions 2-01 to 2-13 are prepared as described below. Each contains glyphosate potassium salt, and was prepared using the 50% a.e. potassium glyphosate solution from Example A, above. Comparative compositions containing glyphosate potassium salt, an alkylpolyglycoside, and alkoxyated alkylamine surfactants (Compositions 2.01 - 2.05) were prepared so as to duplicate the compositions set forth for Examples 1, 2, 3, 7, and 15 of PCT Publication No. WO 00/15037, respectively.

Sample Preparation: To a 4 ounce (117 ml) jar is added approximately 80 grams of the potassium glyphosate solution from Example A. To this is added the appropriate ratio of adjuvant and water. To some samples a small amount of phosphoric acid was added to adjust the pH to between 4.9 and 5.1. The resulting mixture is stirred with a magnetic stirrer (Cole-Parmer, Chicago, IL) until a single phase is obtained. In the case of materials that were viscous and consequently could not be mixed with the magnetic stirrer, the material was rolled on a roller mill (US Stoneware, Manwah, NJ) until the surfactant was dissolved. The material was allowed to stand overnight and observed to insure that it was a single phase and free of air bubbles.

The density was then determined using a Mettler DA-300 Density Meter and the concentrations in grams per liter was calculated.

Cloud points were measured by heating a small amount of the material in a test tube until the solution became hazy or cloudy then removing the test tube from the heat and observing the temperature at which the solution became clear on cooling. The temperature at which the solution became clear is noted as the cloud point.

Viscosities were measured using a Haake Model VT500 (Haake, Inc., Karlsruhe Germany) equipped with the appropriate MV series cup and bob sensor system at a shear rate of 45 sec^{-1} . The temperature was varied with the attached water bath. For a few samples for which insufficient sample was available the viscosities were measured with a Brookfield Model DV-II equipped with a Small Sample Adapter (Brookfield Laboratories, Inc., Stoughton, Mass.).

64725-903 (D)

Table 2. Composition of Formulations of Example B (2.01 through 2.05)

	2.01 (Z1)		2.02 (Z2)		2.03 (Z3)		2.04 (Z7)		2.05 (Z15)	
	%	%Active	%	%Active	%	%Active	%	%Active	%	%Active
Potassium Glyphosate (50%)	78.63	39.33	74.58	37.29	69.48	34.74	69.52	34.76	78.50	39.29
Agrimul PG 2067	15.60	10.92	12.85	9.00	17.73	12.41	12.15	8.50	13.50	9.45
Ethomeen C/15	3.65		3.45		3.86		7.72		3.81	
Propylene Glycol	0.00		0.00		0.00		0.00		1.96	
Water	2.09		9.12		8.93		10.61		4.11	
	100.00		100.00		100.00		100.00		100.00	
Density (g/cc) 20°C		1.3793		1.3509	1.3408		1.3288		1.3824	
g/l glyphosate ae		542 g/l		504 g/l	466 g/l		462 g/l		543 g/l	
Total Surfactant Solids	14.6	201 g/l	12.45	168 g/l	16.3	218 g/l	16.22	216 g/l	13.3	183 g/l
Cloud Point	>90°C		>90°C							
Haake Viscosity	Temp (°C)	cPs	Temp (°C)	cPs	Temp (°C)	cPs	Temp (°C)	cPs	Temp (°C)	CPs
	25	556	25	135	25	229	25	116	25	208
	15	758	15	209	15	394	15	150	15	432
	10	1205	10	226	10	457	10	209	10	501
	5	1488	5	312	5	630	5	226	5	580
	0	1877	0	335	0	668	0	271	0	1035
	-5	2733	-5	485	-5	880	-5	398	-5	1266

64725-903 (D)

TABLE 3. Composition of Formulations of Example B (2.06 through 2.13)

	2.06		2.07		2.08		2.09		2.10		2.11		2.12		2.13	
	%	Active	%	Active	%	Active	%	Active	%	Active	%	Active	%	Active	%	Active
Potassium Glyphosate 50%	74.56	37.28%	69.06	34.53%	73.40	36.70%	69.40	34.70%	78.36	39.18%	72.80	36.40%	74.58	37.29%	74.00	37.00%
Humisman Surfonic AGM 550	12.46		16.07		13.69		0.00		0.00		9.11		9.60		0.00	
Ethomeen C/15	0.00		0.00		0.00		0.00		14.55		0.00		3.46		0.00	
Ethoquad C/12	0.00		0.00		0.00		22.19	16.20%	0.00		0.00		0.00		0.00	
Tomah E-D- 17-5	0.00		0.00		0.00		0.00		0.00		0.00		0.00		12.51	
Phosphoric Acid	0.00		0.48		0.82		0.00		2.37		0.00		0.00		0.00	
Water	12.98		14.39		12.09		8.41		4.72		18.09		12.94		13.49	
	100.00		100.00		100.00		100.00		100.00		100.00		100.00		100.00	
Density (g/cc) 20° C	1.3238		1.3019		1.3264		1.2932		1.3493		1.3085		1.321 5		1.334 9	
g/l glyphosate ae		494		449		487		449		529		476		493		494
Total Surfactant Solids	12.46	165 g/l	16.1	209 g/l	13.7	182 g/l	16.2	209 g/l	14.6	196	9.10	119	12.50	165	12.51	167
Cloud Point	70 °C		55 °C		55 °C		>90°C		>90°C		60 °C		75 °C		>90°C	
Haake Viscosity	Temp (°C)	cPs	Temp (°C)	cPs	Temp (°C)	cPs	Temp (°C)	cPs	Temp (°C)	cPs	Temp (°C)	cPs	Temp (°C)	cPs	Temp (°C)	cPs
	25	43	25	73	25	70	25	3	25	25	25	25	25	32	25	54
	15	55	15	102	15	82	15	15	15	15	15	33	15	61	15	112
	10	91	10	122	10	131	10	29	10	10	10	36	10	109	10	123
	5	125	5	144	5	177	5	33	5	5	5	46	5	113	5	160

64725-903 (D)

109

Table 4. Surfactants used in Example C

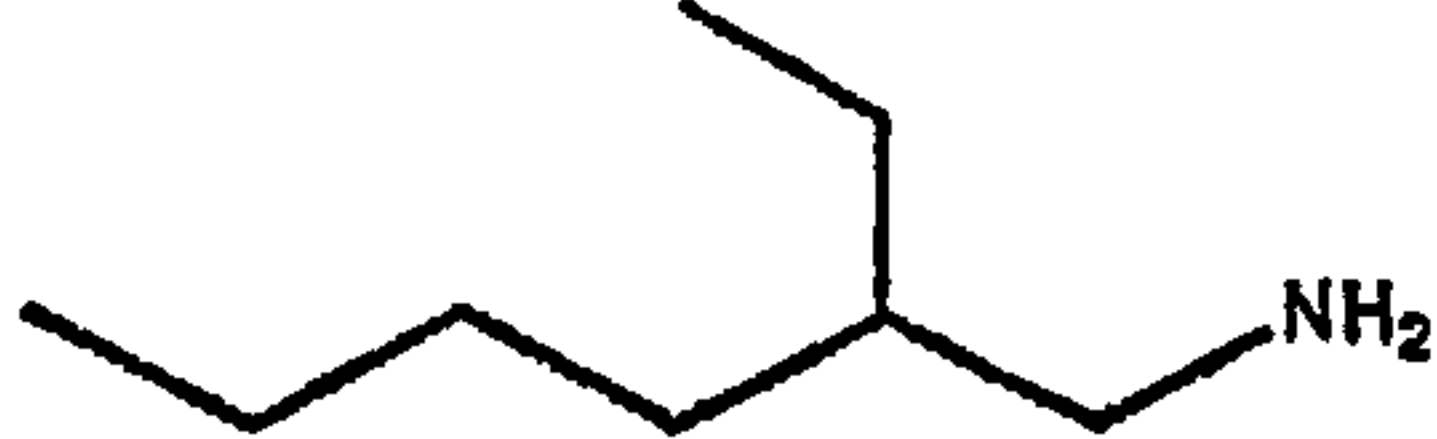
Surfactant	Chemical Structure	Trade name and supplier
A		104-75-6 (Aldrich)
B	$C_{16}H_{37}-N$	Pfaltz & Bauer (www.pfaltzandbauer.com)
C	$C_{18}H_{37}-N-(CH_2CH_2O)_7CH_3$	not commercially available (prepared in accordance with Example D, above)
D	$C_{18}H_{37}-N-(EO)_{4.4}H$	not commercially available (prepared by the ethoxylation of N-methyloctadecylamine)
E	$C_{18}H_{37}-N-(EO)_{5.3}H$	not commercially available (prepared by the ethoxylation of N-methyloctadecylamine)



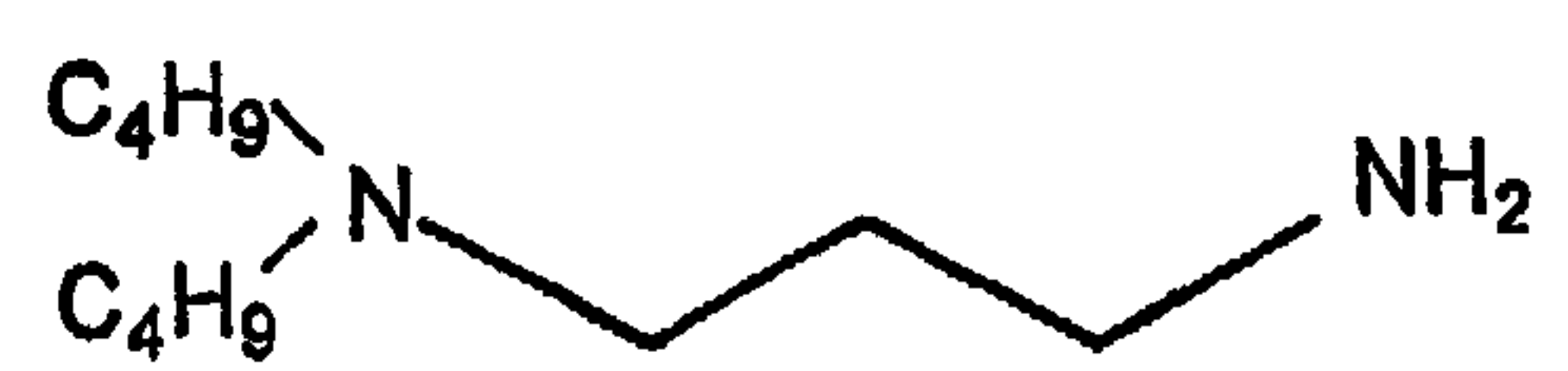
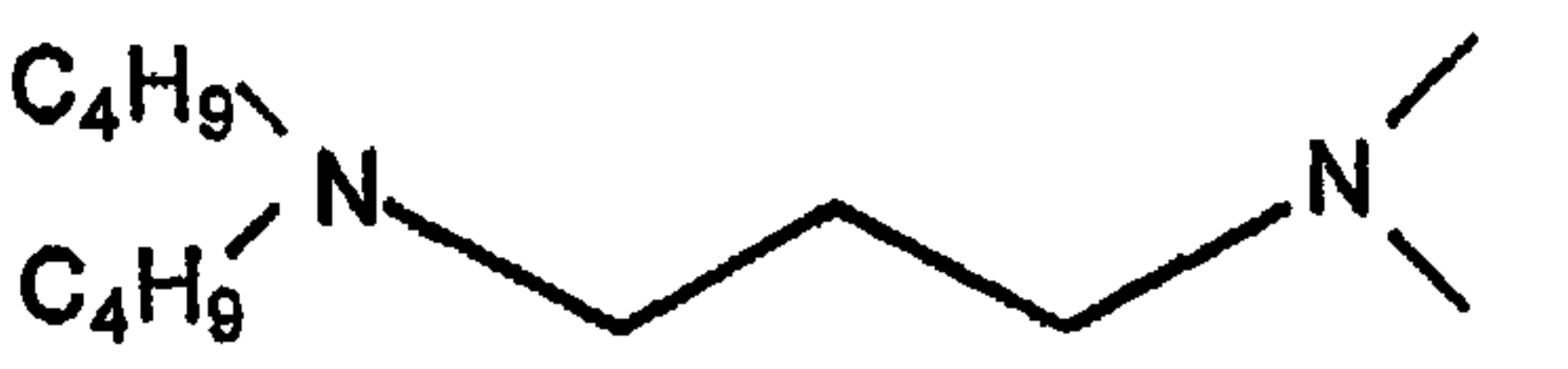
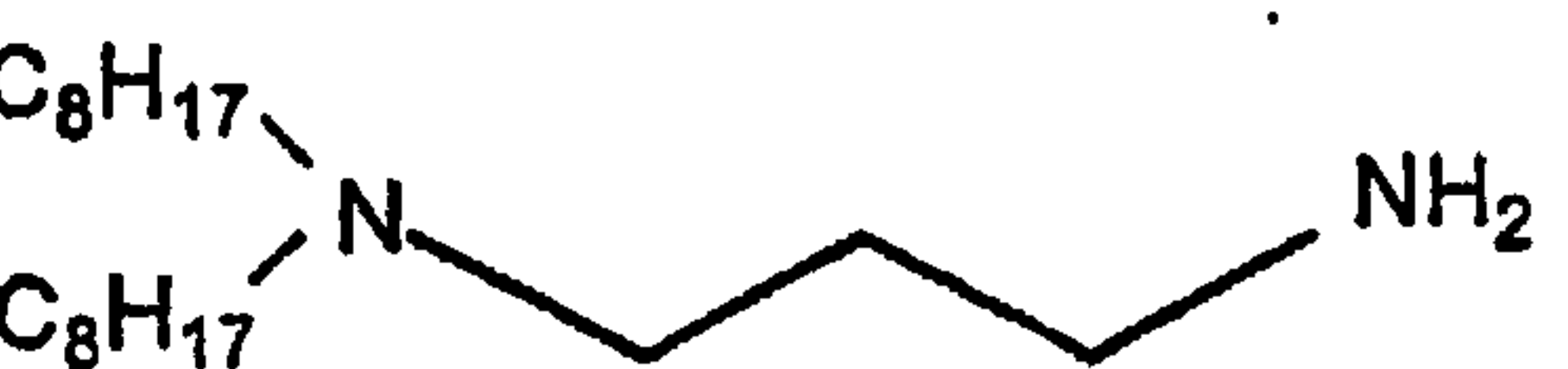
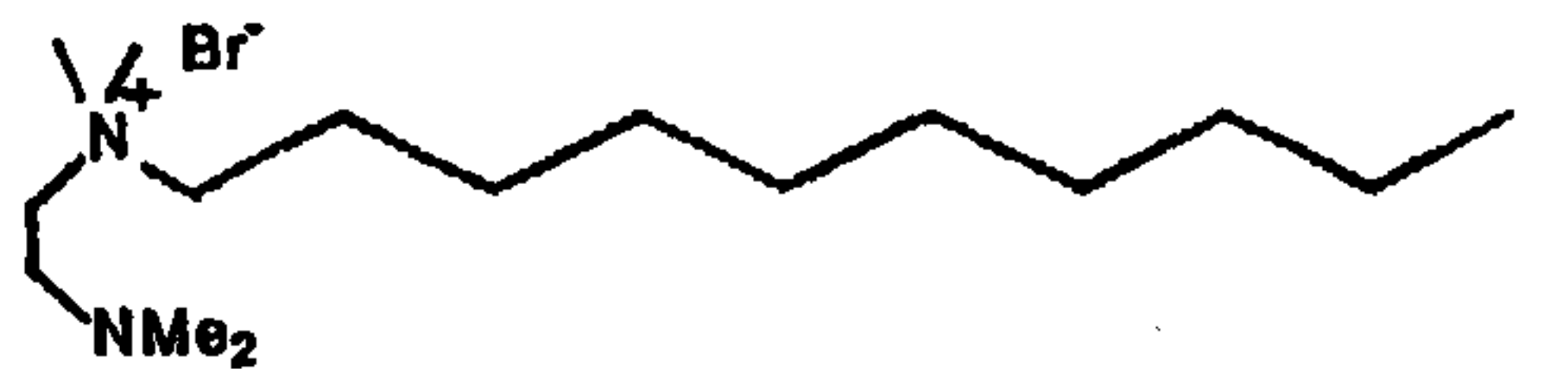
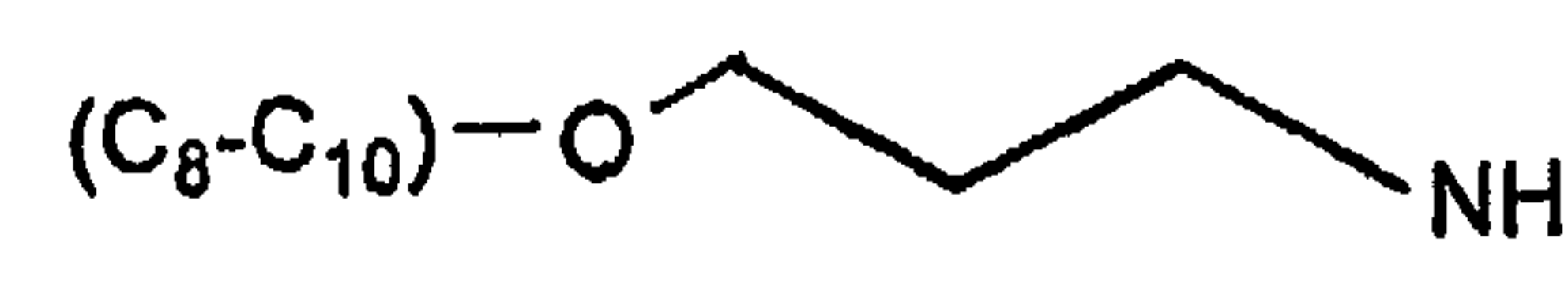
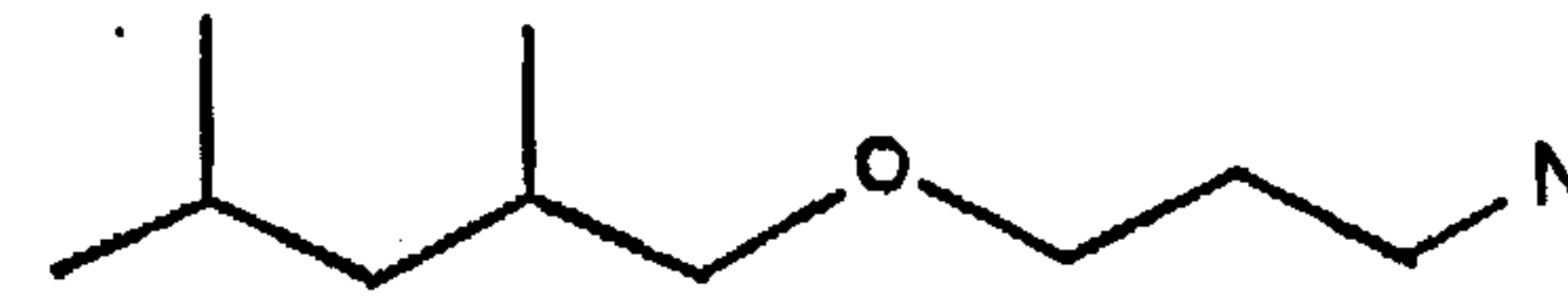

64725-903 (D)

110

F	 <p>Chemical structure showing a central benzene ring substituted with two butyl groups (C₄H₉) and two 2-aminoethyl groups (NH₂).</p>	102-83-0 (Aldrich)
G	 <p>Chemical structure showing a central benzene ring substituted with two butyl groups (C₄H₉) and two dimethylamino groups (N(CH₃)₂).</p>	CAS 62478-76-6 (not commercially available)
H	 <p>Chemical structure showing a central benzene ring substituted with two octyl groups (C₈H₁₇) and two 2-aminoethyl groups (NH₂).</p>	CAS 64184-58-3 (not commercially available)
I	 <p>Chemical structure showing a decyl chain (10 carbons) attached to a nitrogen atom. The nitrogen atom is also bonded to two methyl groups (NMe₂) and a bromine atom (Br).</p>	CAS 123714-89-6 (not commercially available)
J	 <p>Chemical structure showing a central benzene ring substituted with two (C₈-C₁₀) alkoxy groups and two 2-aminoethyl groups (NH₂).</p>	PA-1214 (Tomah)
K	 <p>Chemical structure showing a central benzene ring substituted with two 2-aminoethyl groups (NH₂) and two methyl groups (CH₃) at the 2 and 4 positions.</p>	PA 10 (Tomah)

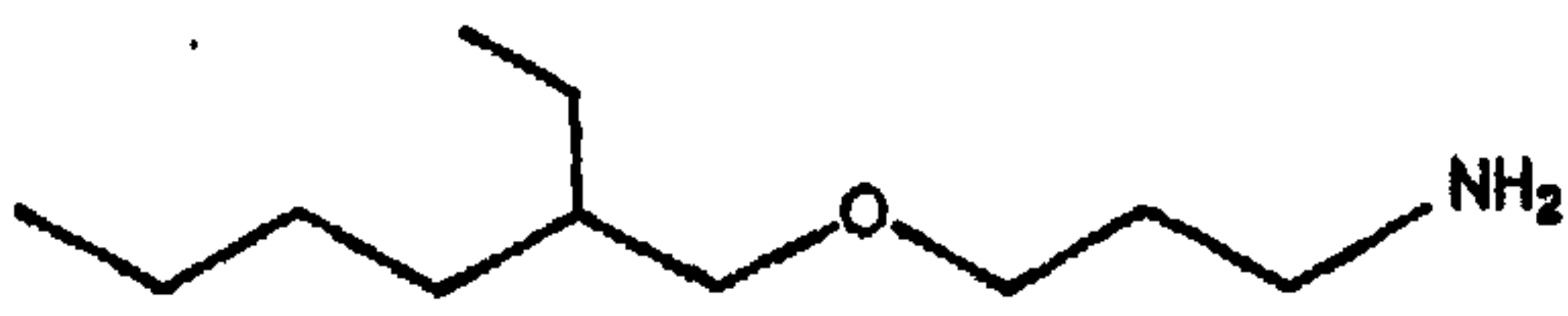
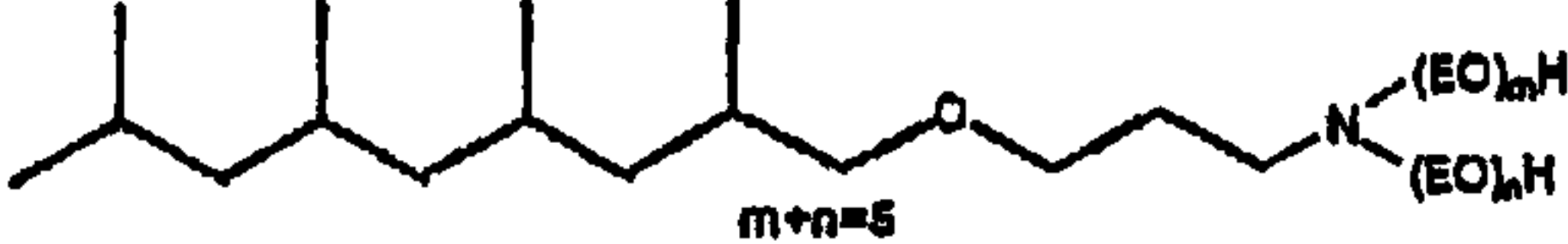
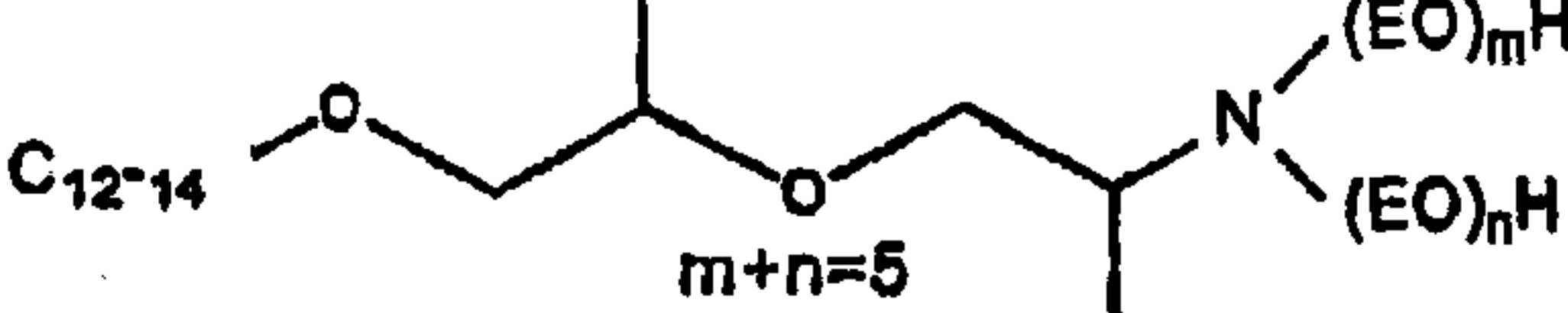
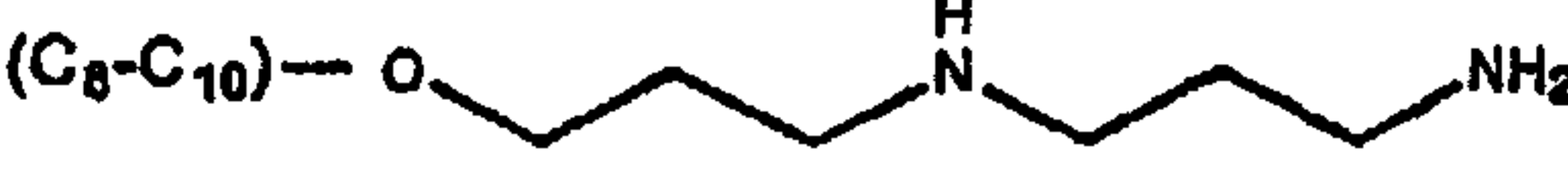
64725-903 (D)

111

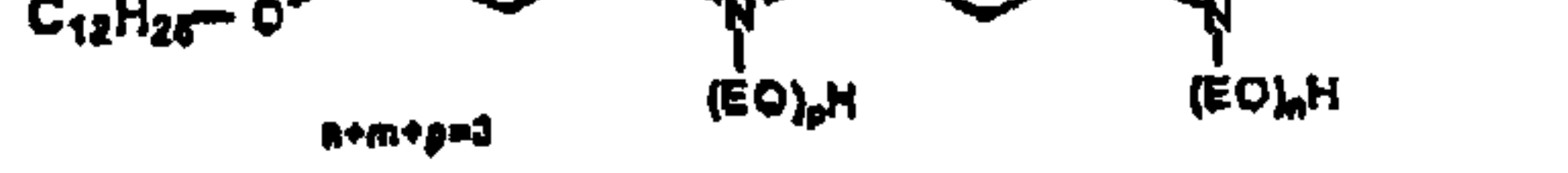
L		PA-12EH (Tomah)
M		E-17-5 (Tomah)
N		Surfonic AGM - 550 (Huntsman Petrochemical Corp.)
O		DA-1214 (Tomah)
P		DA-1618 (Tomah)
Q		DA-18 (Tomah)
R		DA-14 (Tomah)
S		DA-17 (Tomah)
T		B1910-5 (Witco)

64725-903 (D)

112

U	<p>$C_{12}H_{25}-O-$ Total EO = 6</p>	B1910-6 (Witco)
V	<p>$C_{12}H_{25}-O-$ Total EO = 8</p>	B1910-9 (Witco)
W	<p>$(C_{10}-C_{12})-$</p>	Mackine 101
X	<p>$C_8F_{17}-S(=O)_2-NH-$ and $N^+ Cl^-$</p>	Fluorad FC-754
Y	<p>$(COCO)-N^+ O^-$</p>	Chemoxide L70
Z	<p>$C_{11}C_{10}C_9-O-$ (glucoside)</p>	Agrimul APG 2069
AA	<p>$C_8H_{17}-NH-$</p>	23323-37-7 (Aldrich)
BB	<p>$C_{12}H_{25}-N-$</p>	4182-44-9 (Acros)
CC	<p>$(R)-N-$</p>	Genamin 3119(Clariant) CAS 85632-63-9

64725-903 (D)

113

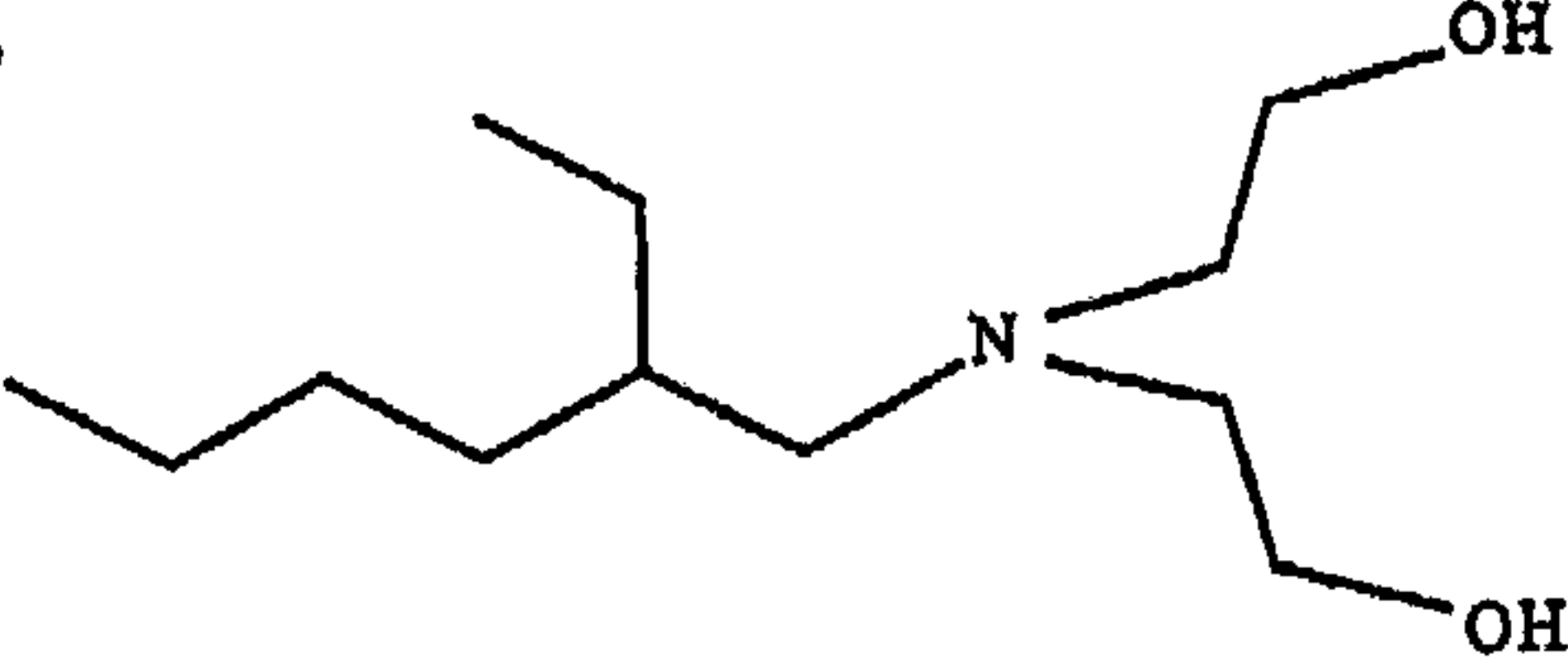
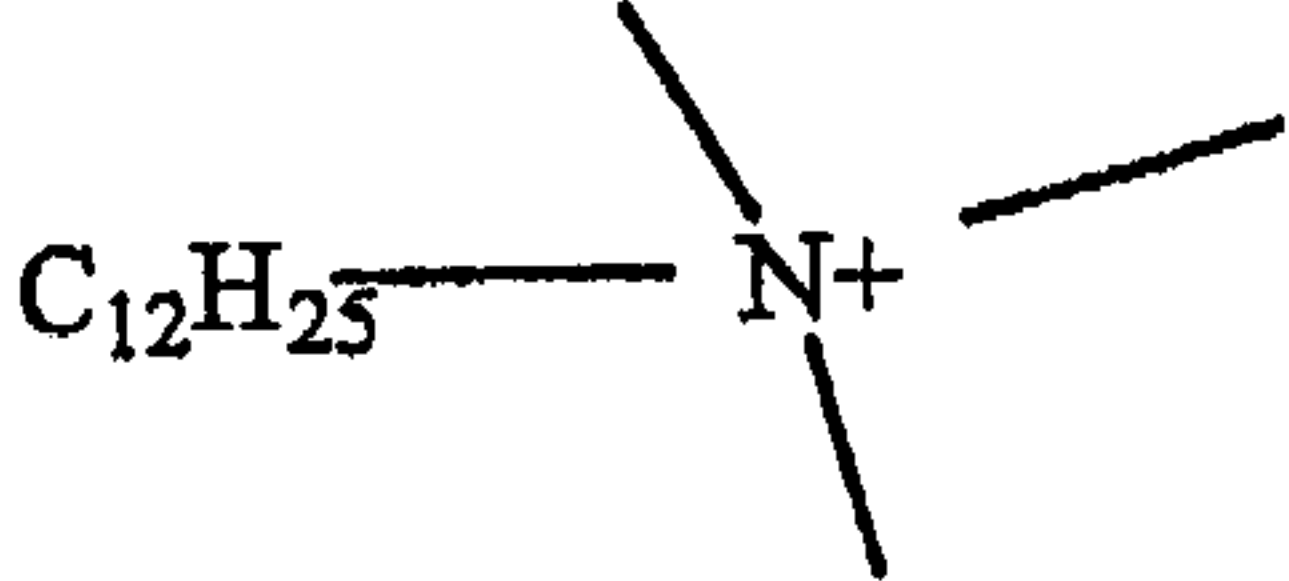
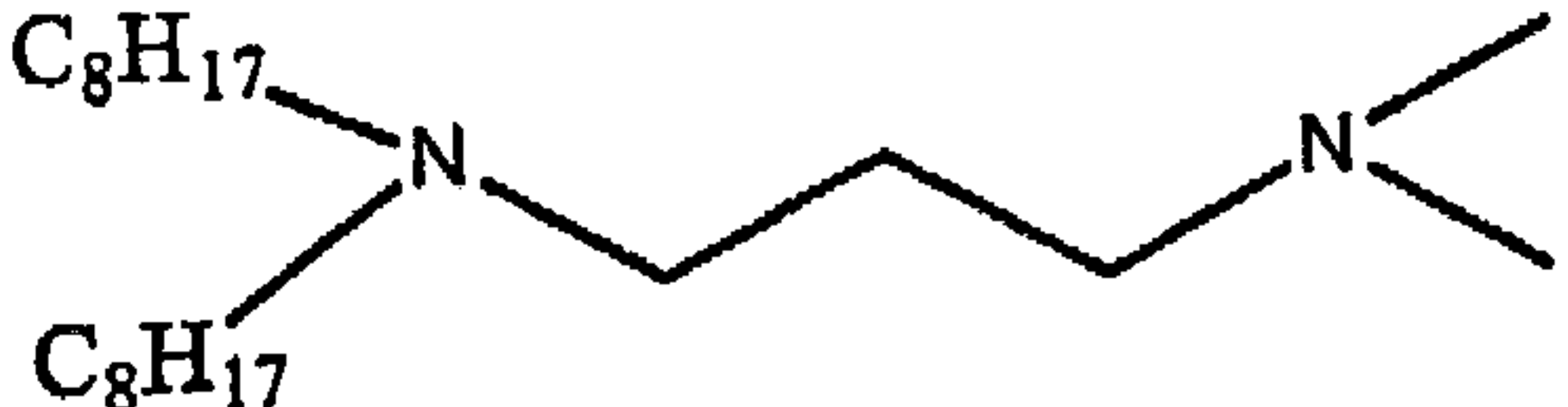
DD		Jeffamine EDR-148
EE	$ \begin{array}{c} \text{O}^- \\ \\ \text{(tallow)} - \text{N}^+ - (\text{EO})_m\text{H} \\ \\ (\text{EO})_n\text{H} \\ n+m=5 \end{array} $	Custom B-1965-F (Witco)
FF		6637025
GG		
HH	$ \begin{array}{c} \text{C}_{18}\text{H}_{37} - \text{N} - (\text{CH}_2\text{CH}_2\text{O})_{5.9}\text{H} \\ \\ \text{---} \end{array} $	6801342
II	$ \begin{array}{c} \text{C}_{12}\text{H}_{25} - \text{N} - (\text{CH}_2\text{CH}_2\text{O})_{7.5}\text{H} \\ \\ \text{---} \end{array} $	6801343
JJ		NBP6476266

64725-903 (D)

114

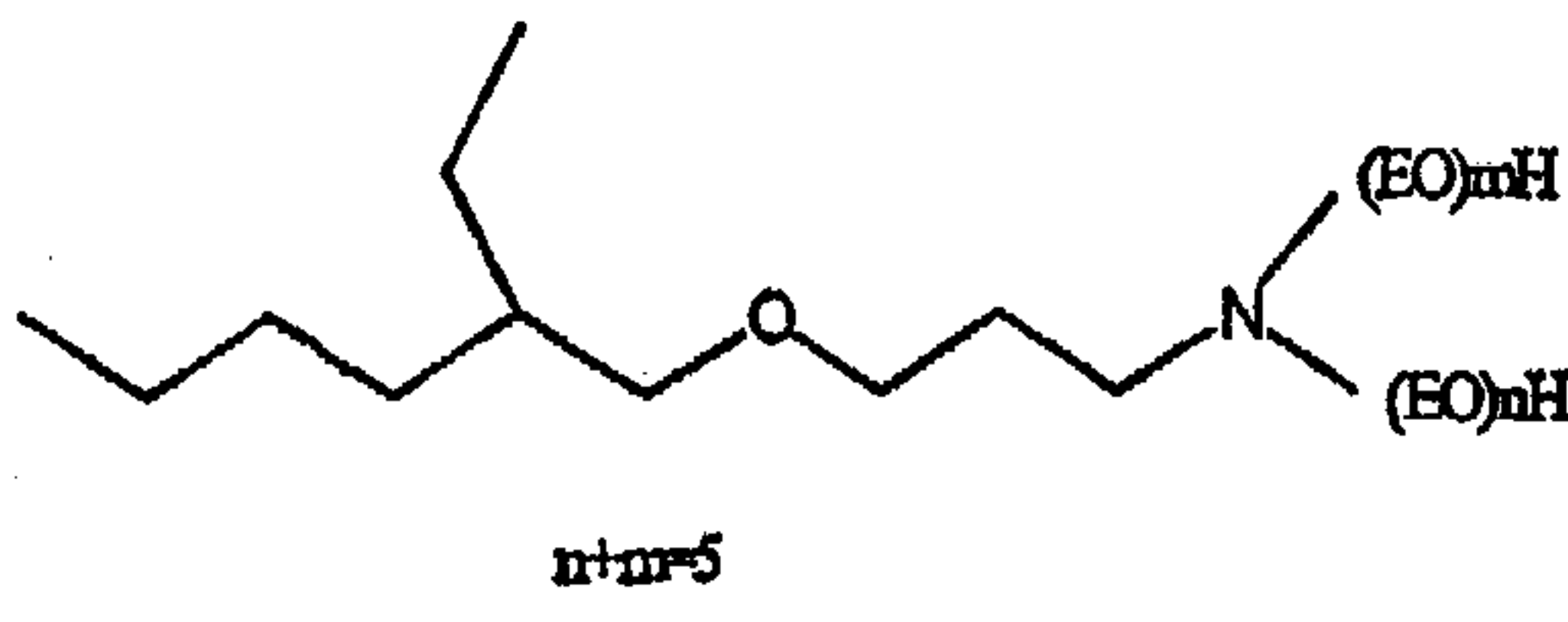
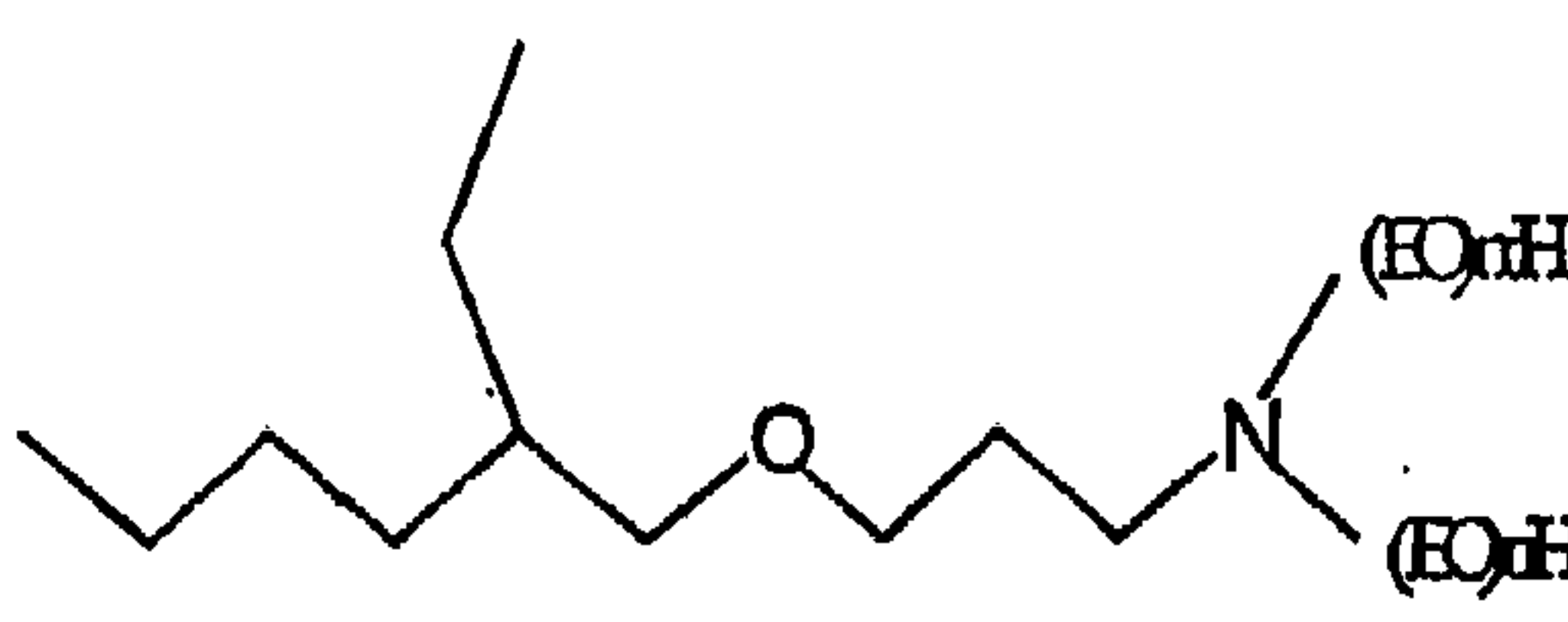
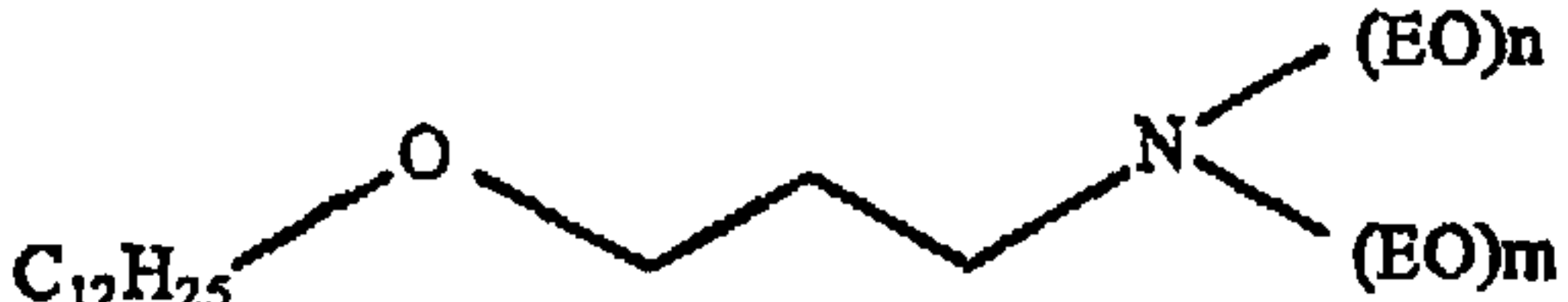
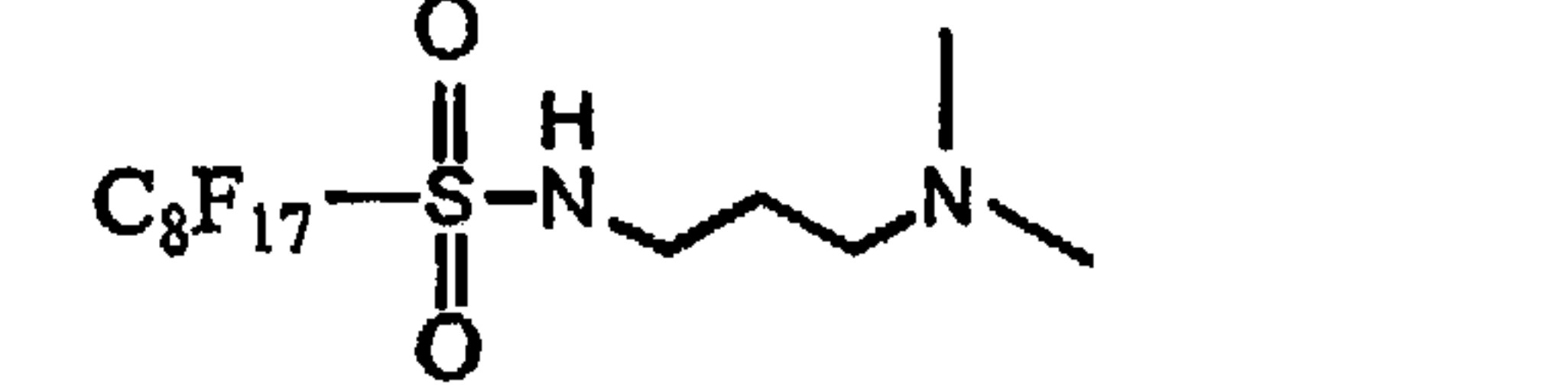
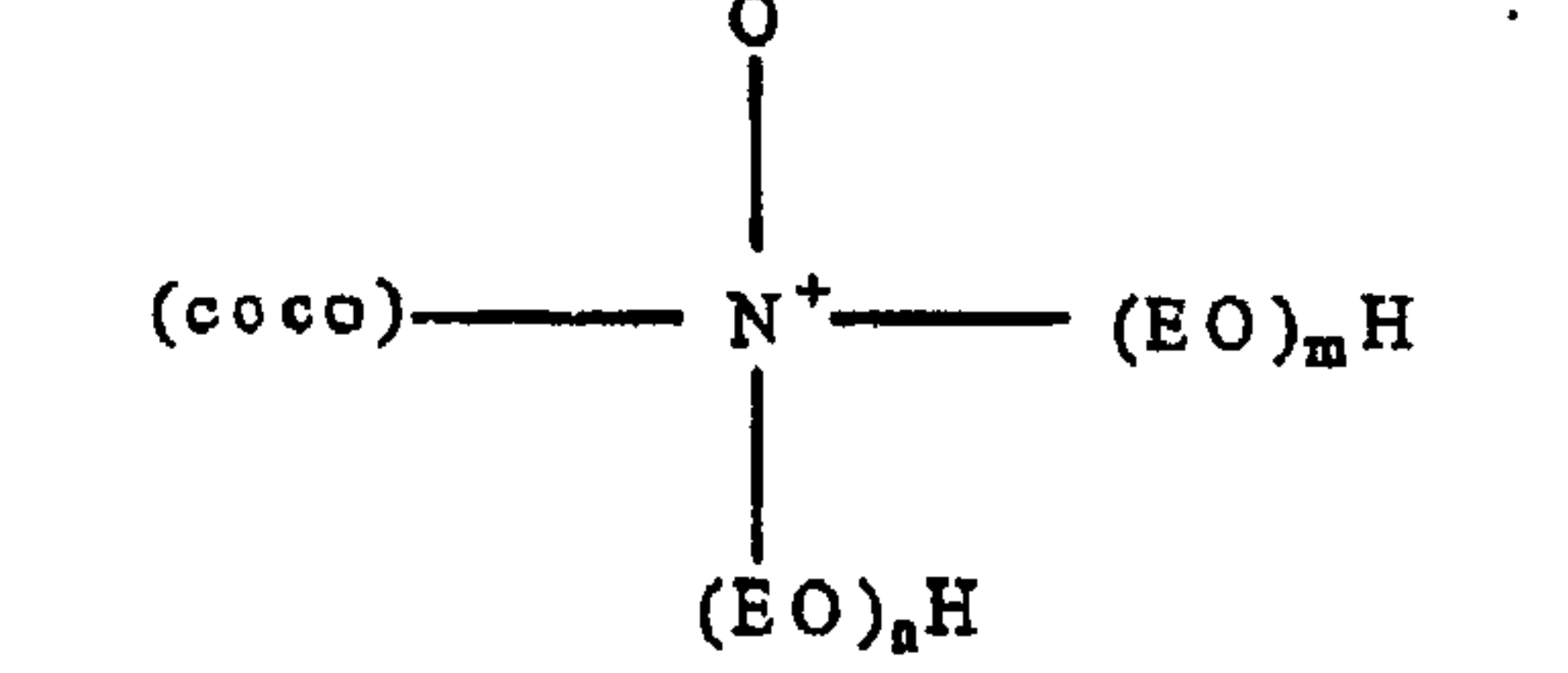
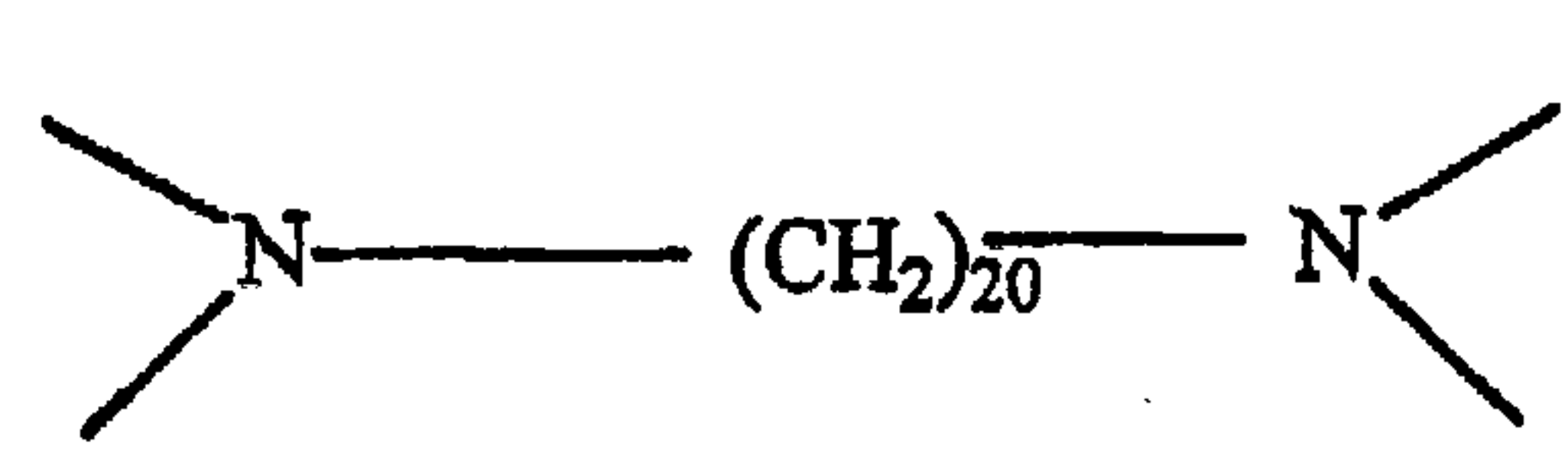
KK		208540-68-5
LL	 <p style="text-align: center;">$n+m=5$</p>	6801357
MM	 <p style="text-align: center;">$n+m=7$</p>	6801359
NN		Witco Exp-5388-48 (MON 59124)
OO		S. Auinbauh ck CAS
PP	 <p style="text-align: center;">$n+m=5$</p>	Witco custom B- 1965-F
QQ		6747747

64725-903 (D)

115

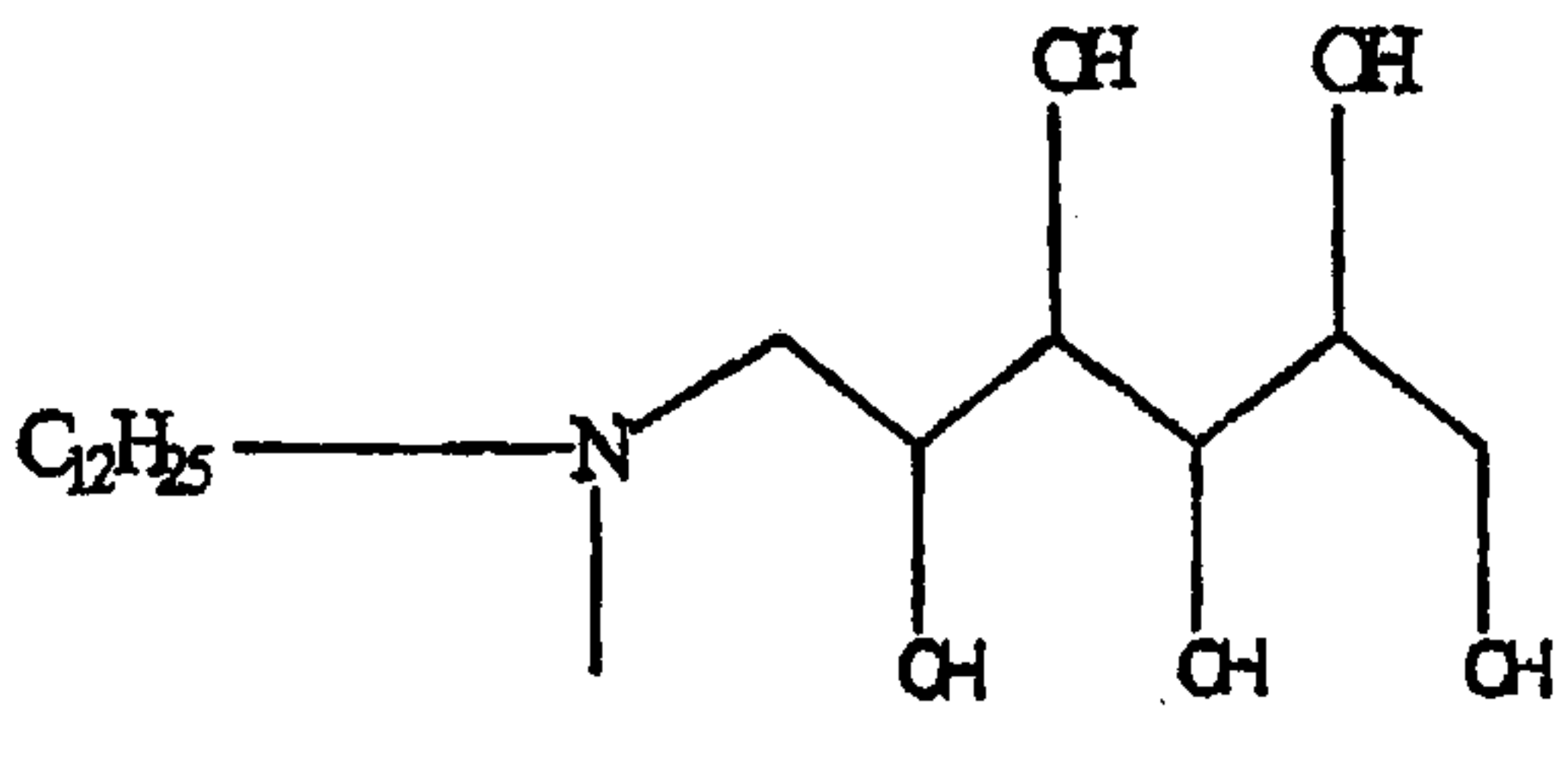
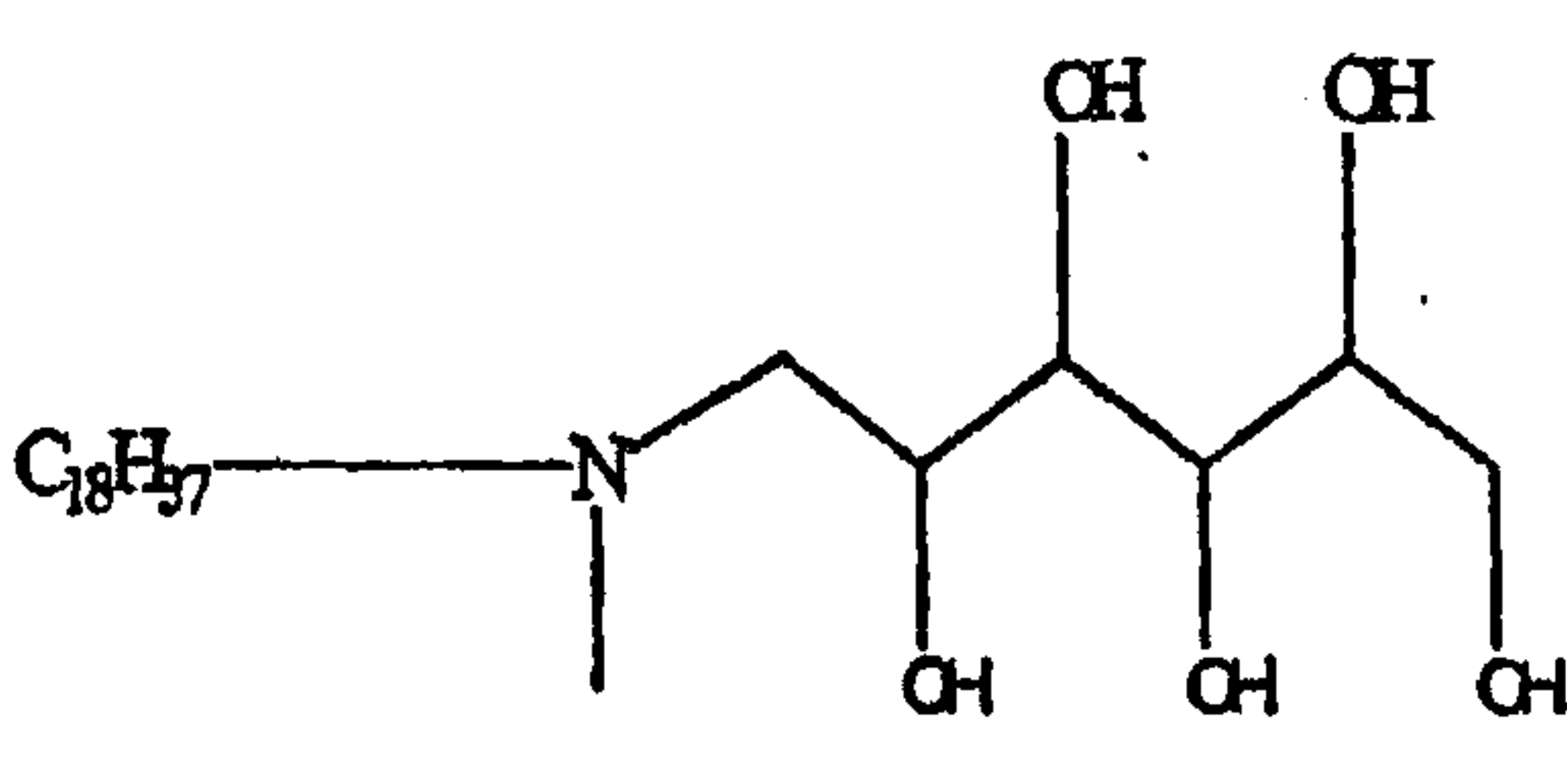
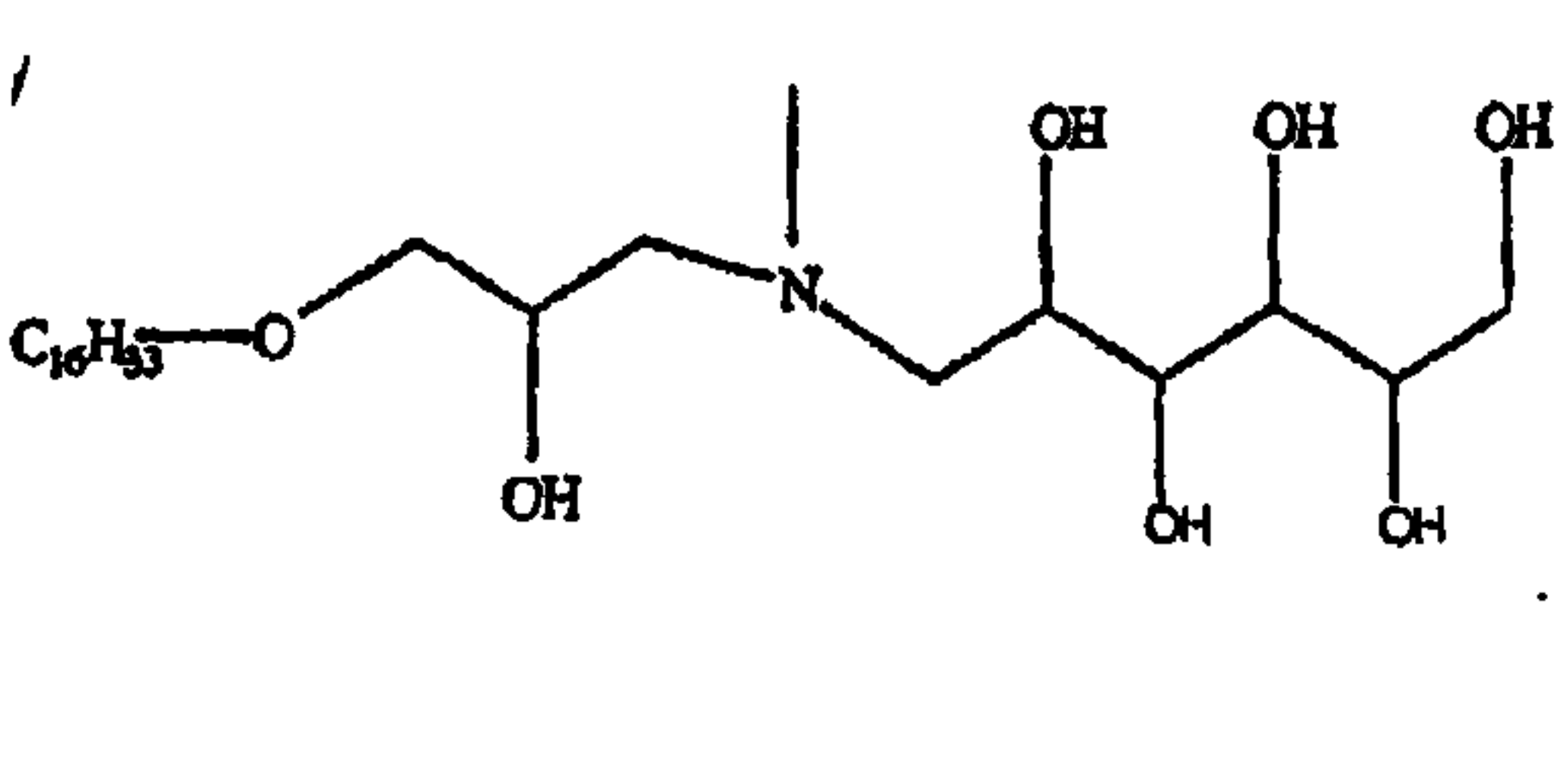
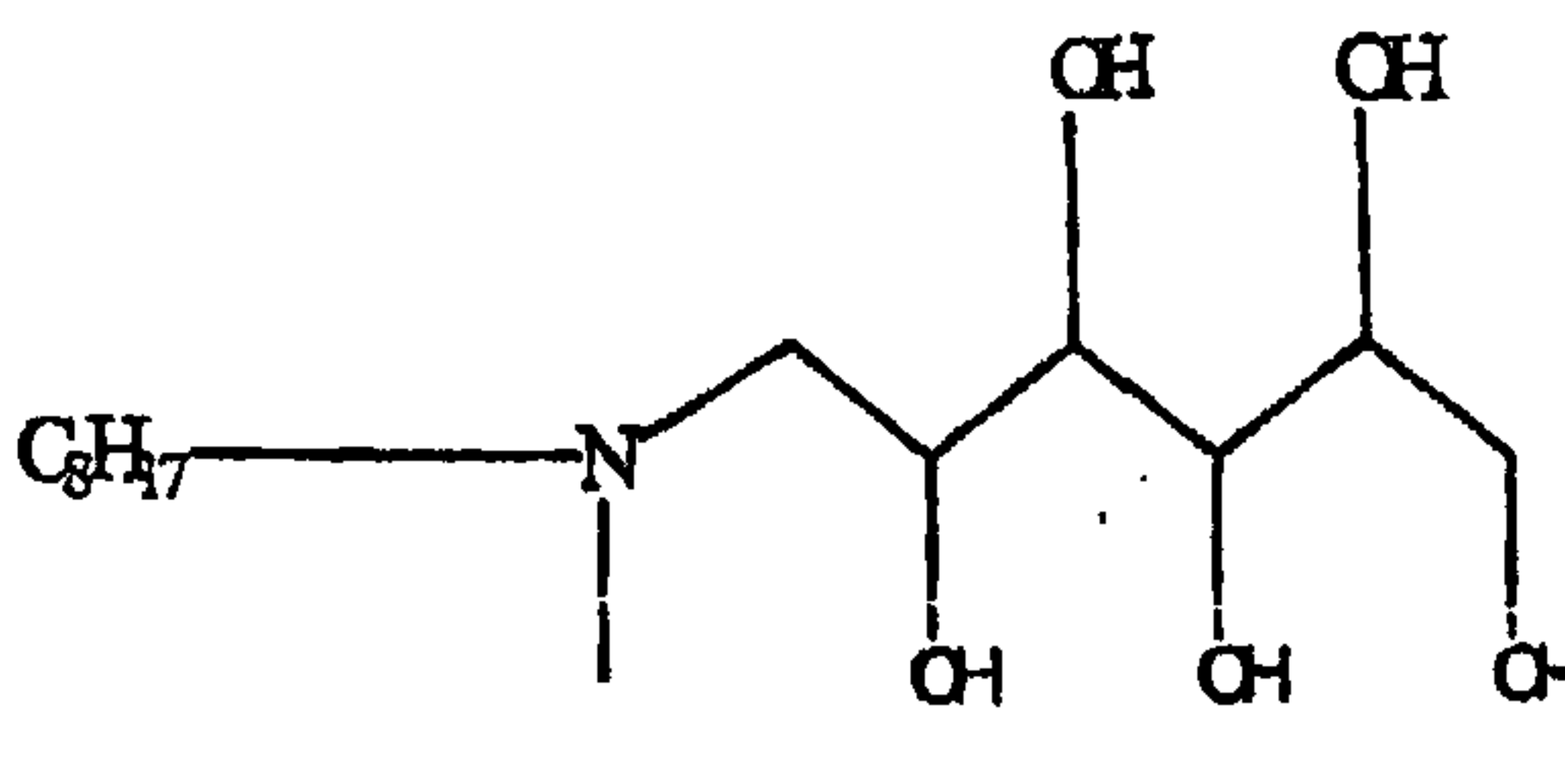
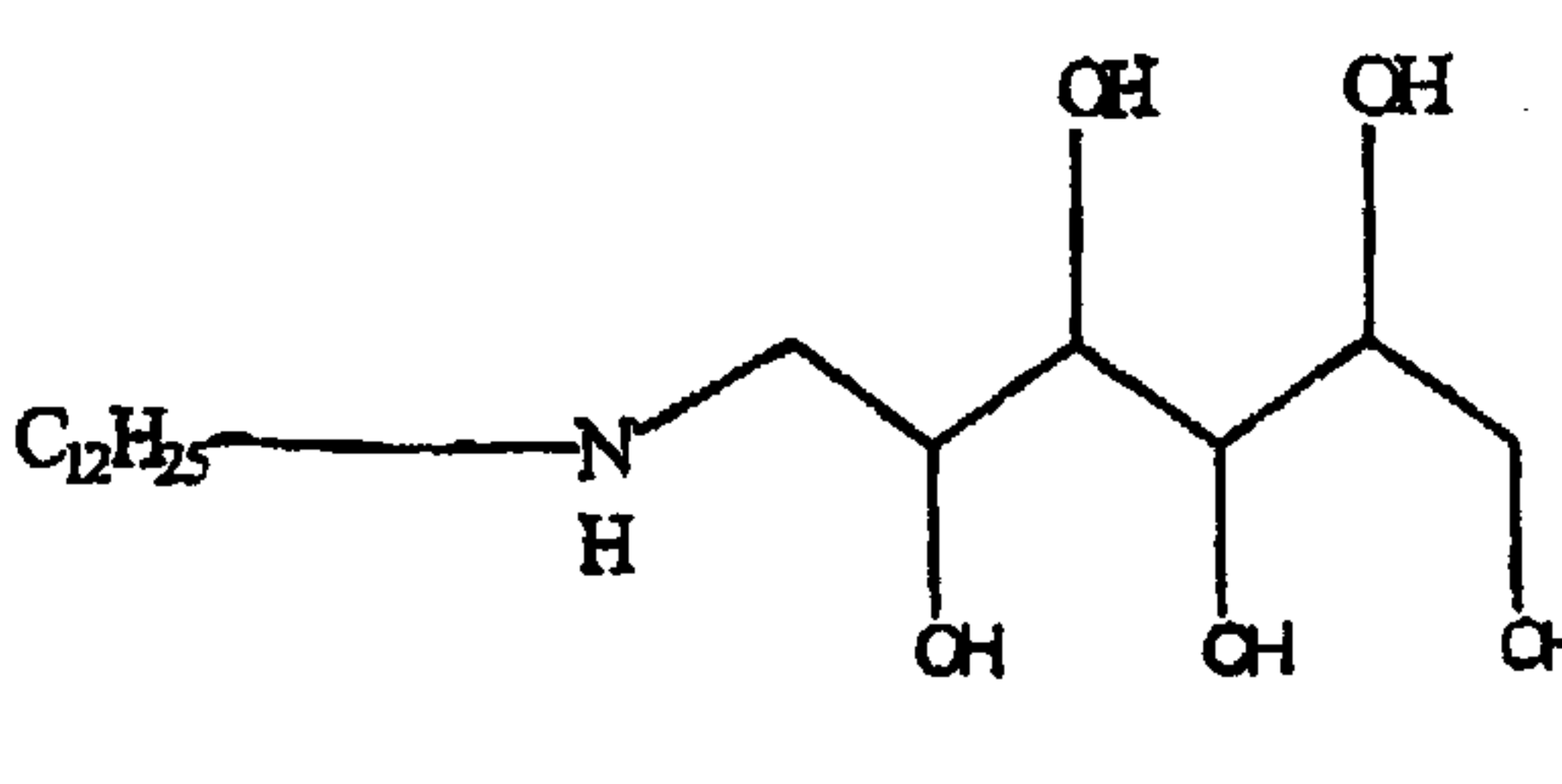
RR	 <chem>CCCC(O)C(O)C(O)CN(C)CCCCCCCCCCCC</chem>	6788433
SS	 <chem>CCCC(O)C(O)C(O)CN(C)CCCCCCCCCCCCCCCCCCCC</chem>	6788438
TT	 <chem>CCCC(O)C(O)C(O)CN(C)CCOC(C)CCCCCCCCCCCC</chem>	6916805
UU	 <chem>CCCC(O)C(O)C(O)CN(C)CCCCCCCC</chem>	6788445
VV	 <chem>CCCC(O)C(O)C(O)CN(C)CCCCCCCCCCCC</chem>	Clariant

64725-903 (D)

116

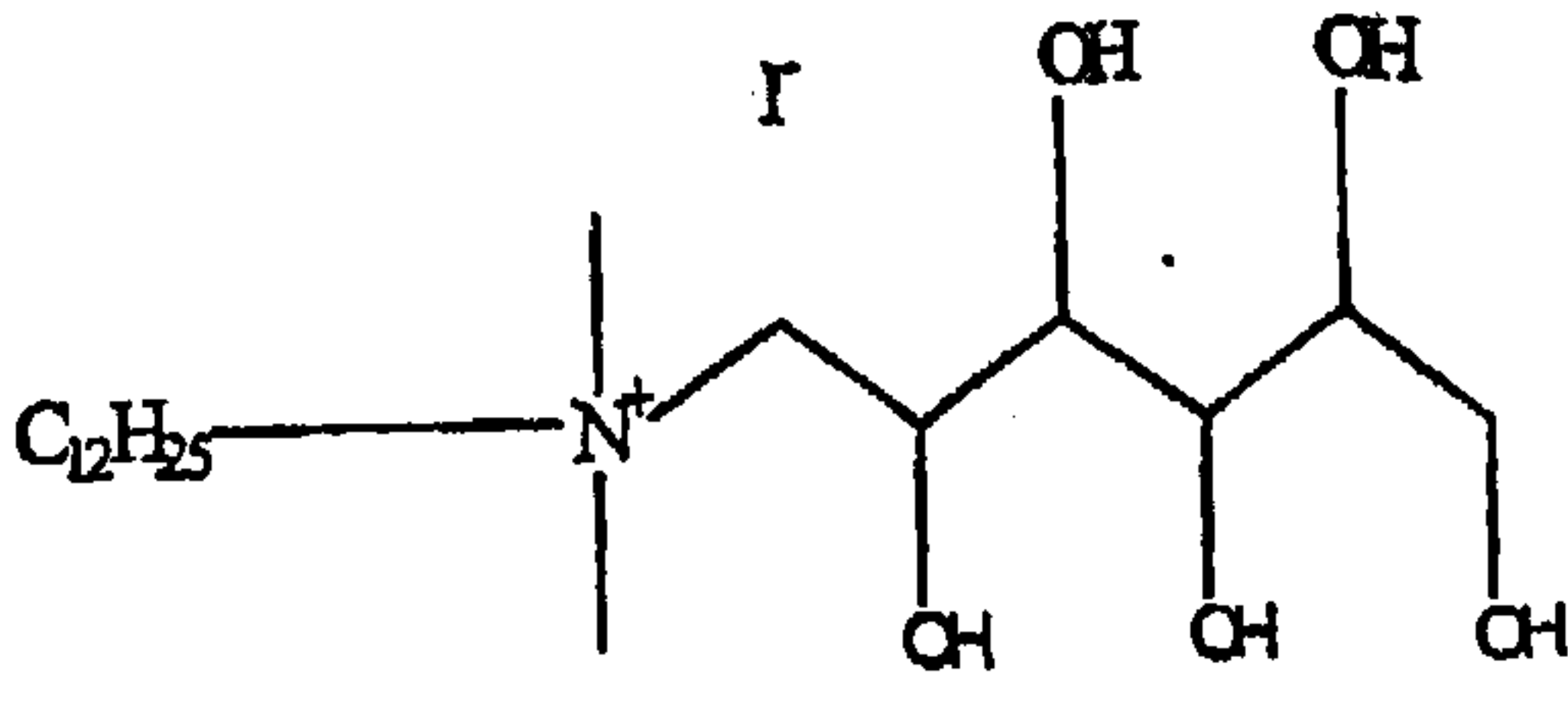
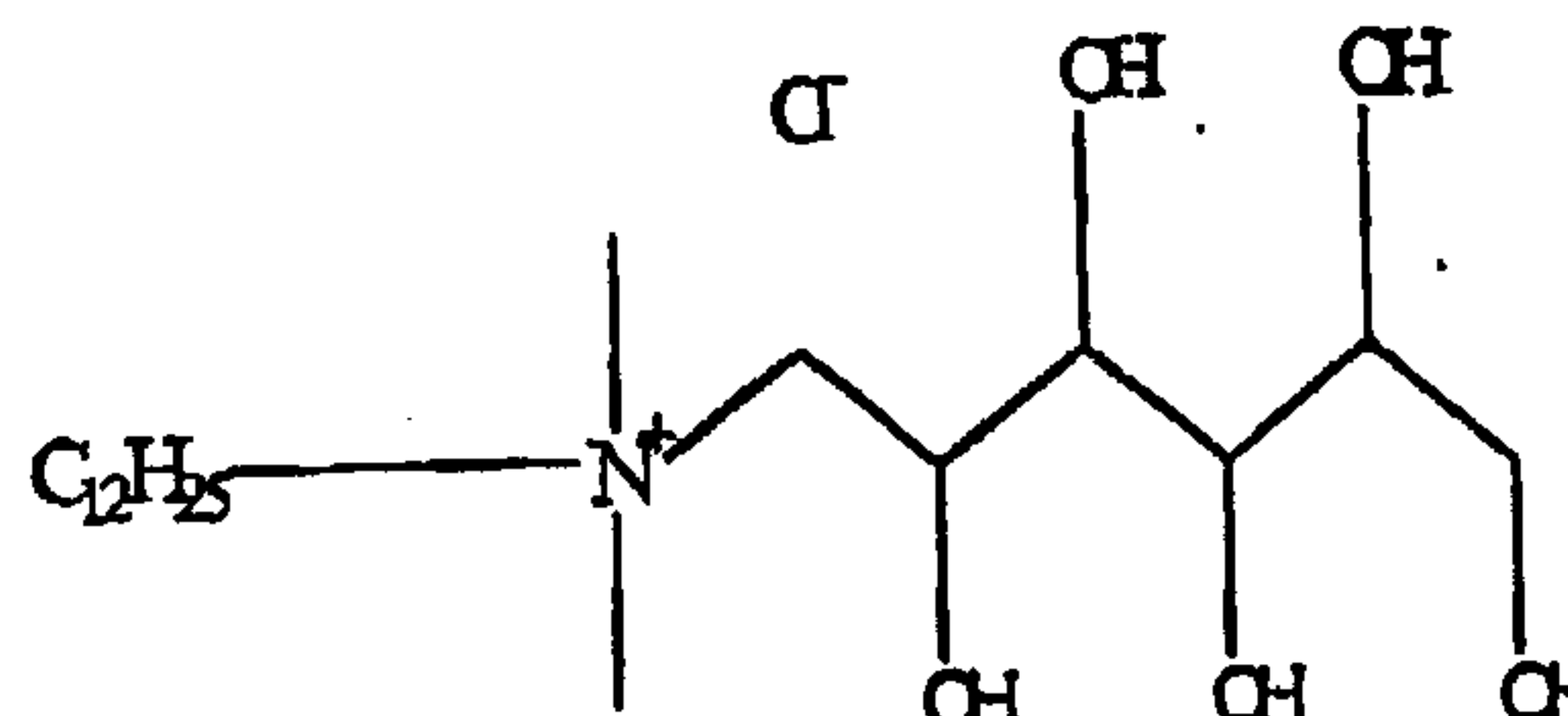
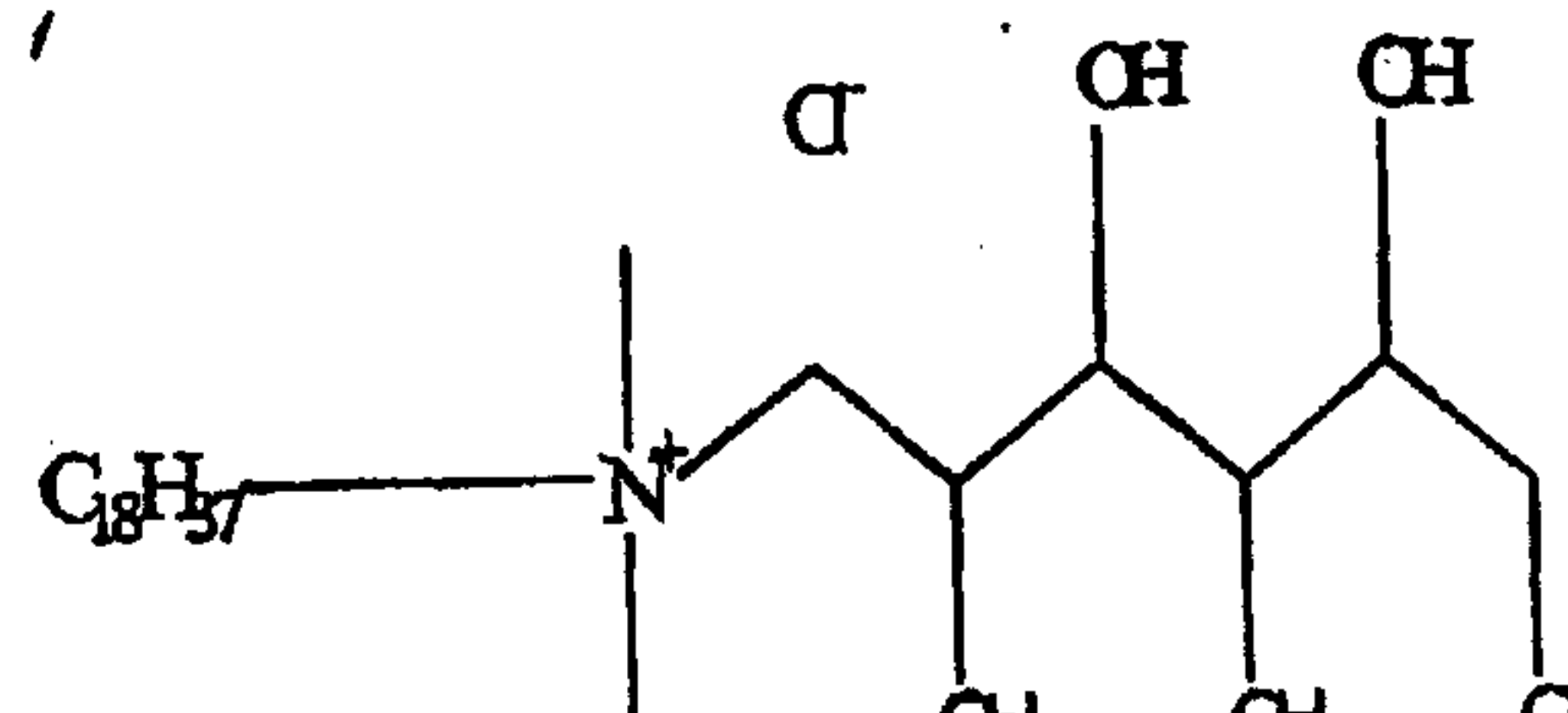
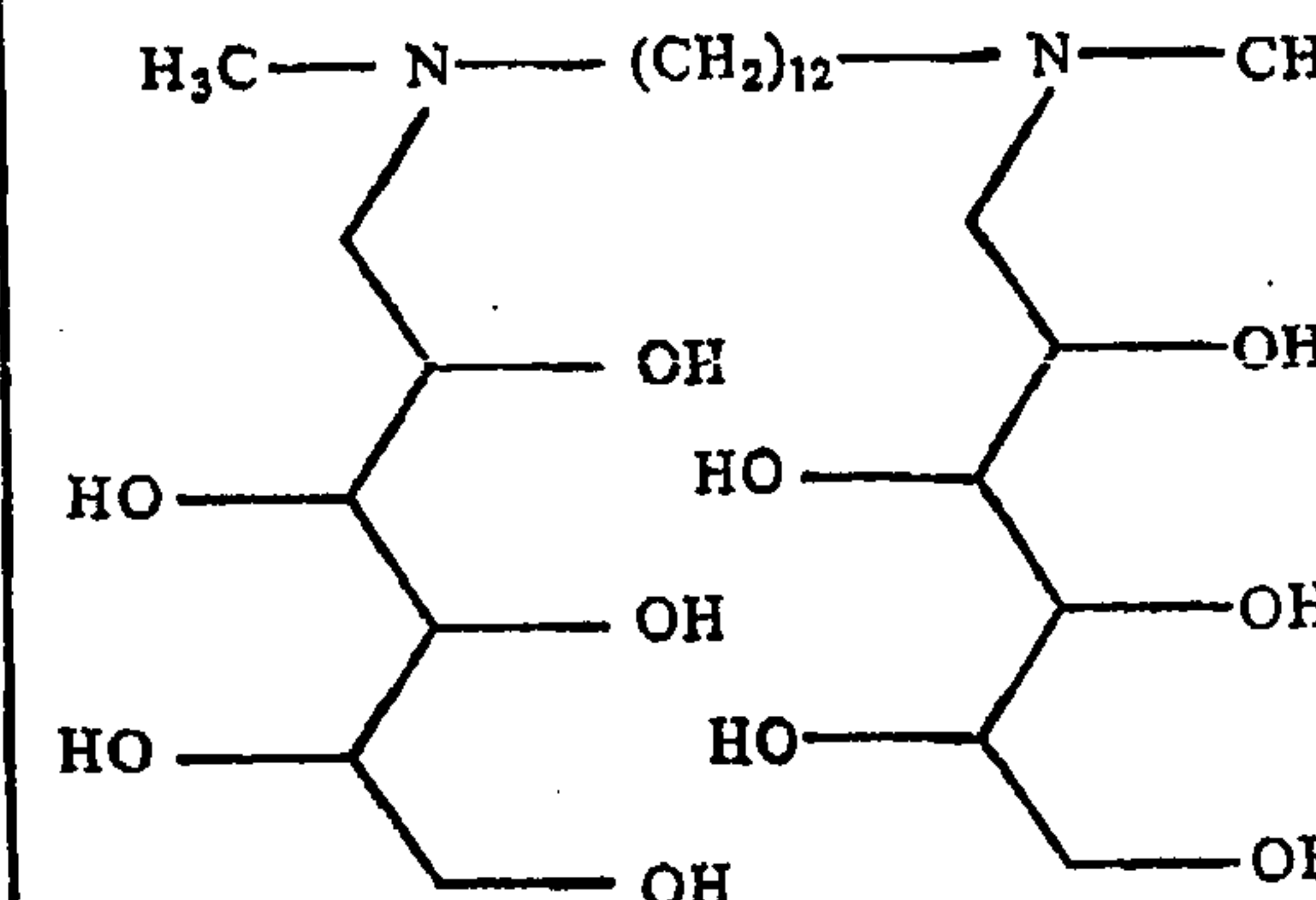
WW		6788437
XX		6788449
YY		6788440
ZZ		6788462

64725-903 (D)

117

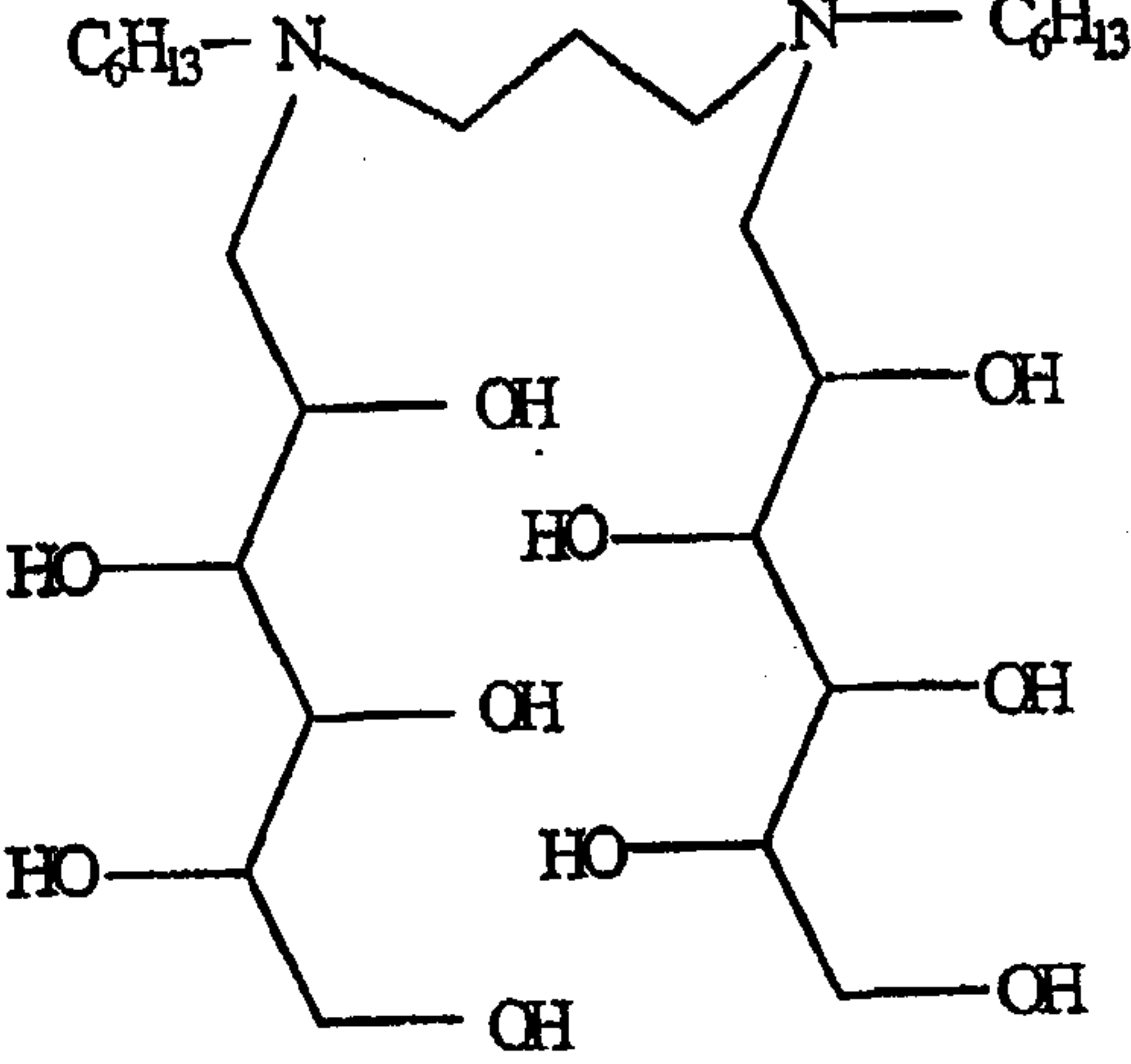
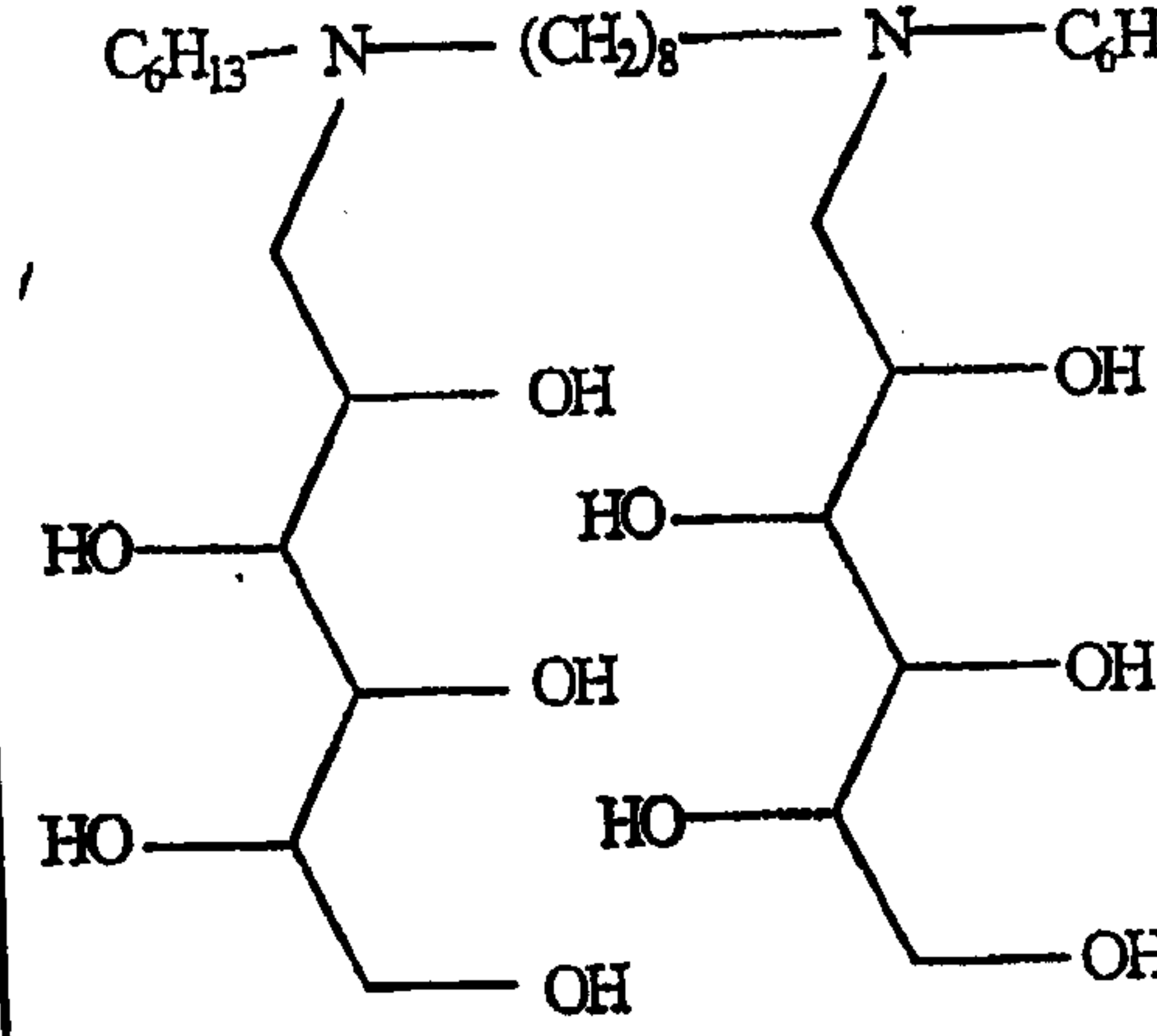
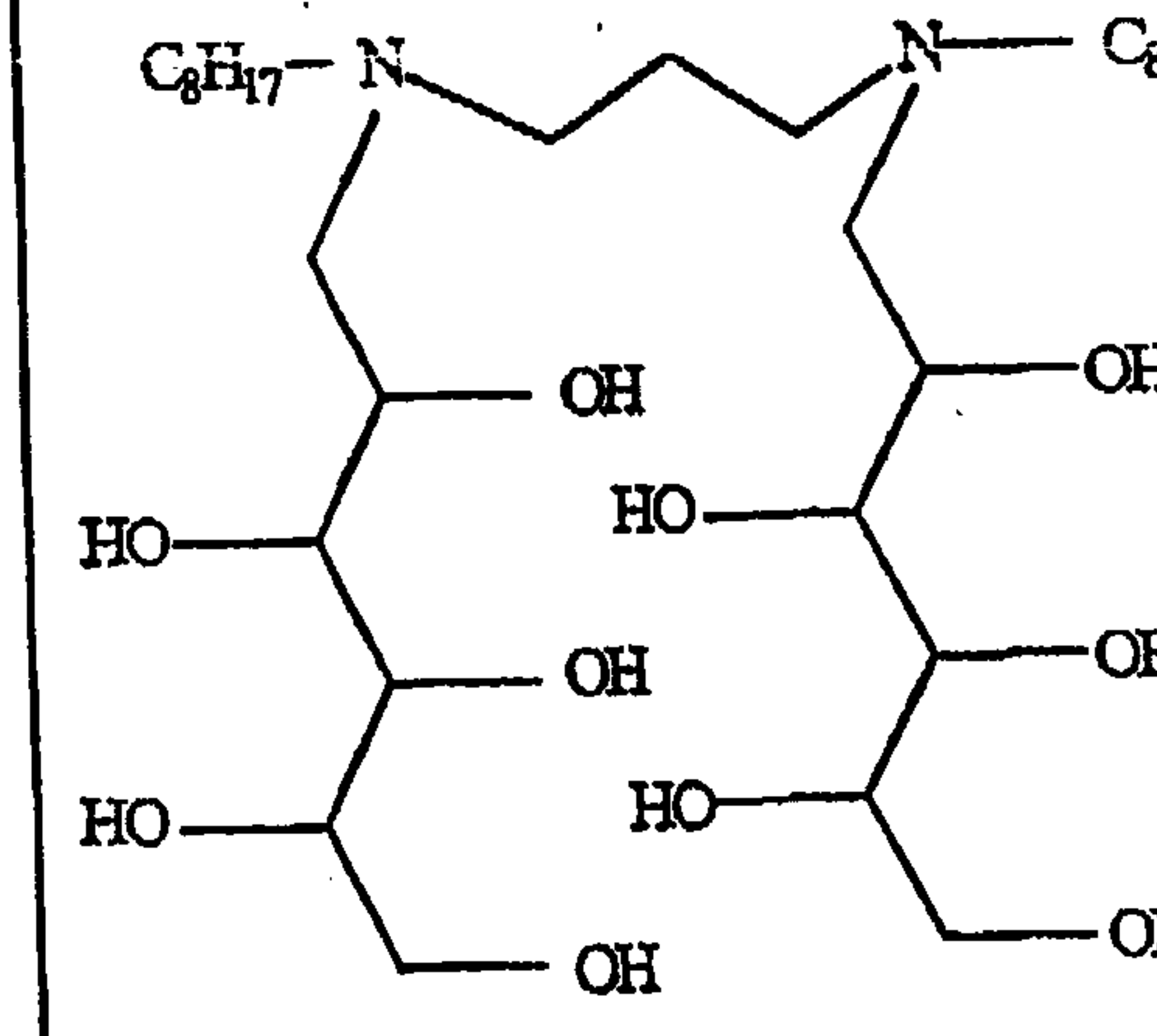
AAA	 <p>Chemical structure showing two C_6H_{13} groups attached to nitrogen atoms, forming a bicyclic system with four hydroxyl (OH) groups.</p>	6788468
BBB	 <p>Chemical structure showing two C_6H_{13} groups attached to nitrogen atoms, forming a bicyclic system with four hydroxyl (OH) groups. The bridge between the nitrogens is labeled $(CH_2)_8$.</p>	6788476
CCC	 <p>Chemical structure showing two C_8H_{17} groups attached to nitrogen atoms, forming a bicyclic system with four hydroxyl (OH) groups.</p>	6788465

64725-903 (D)

118

c

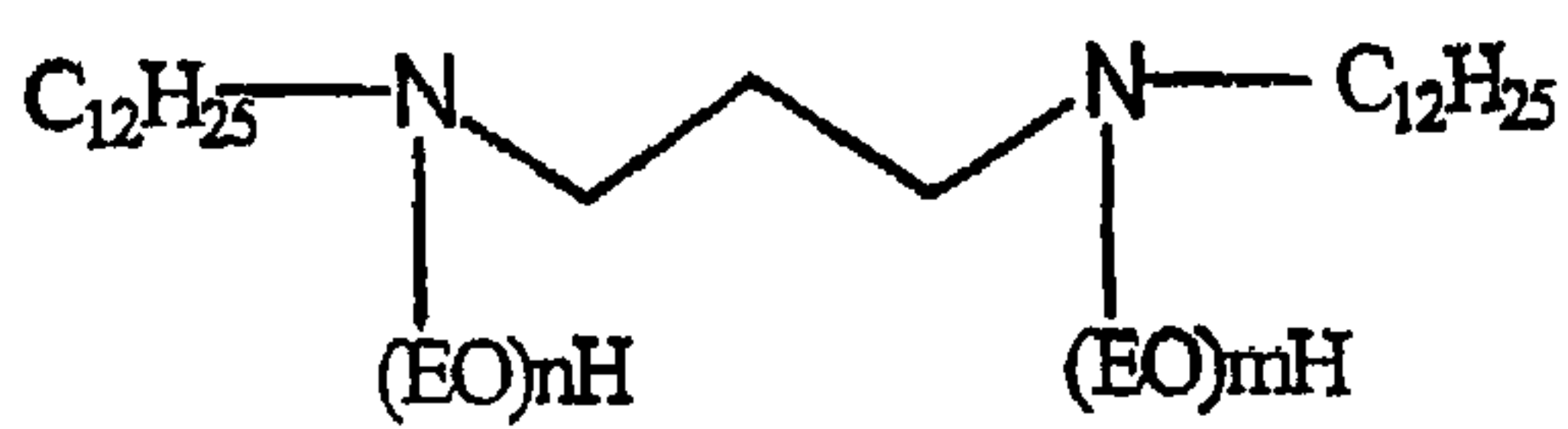
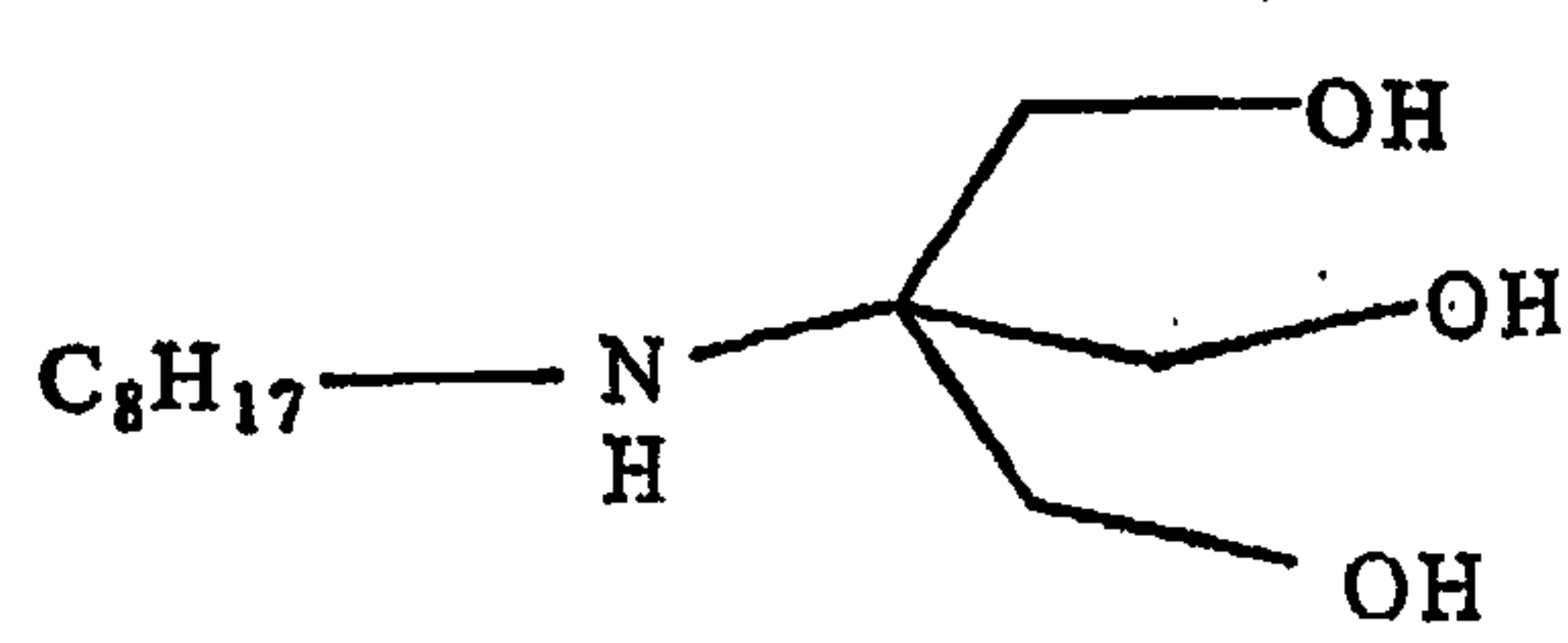
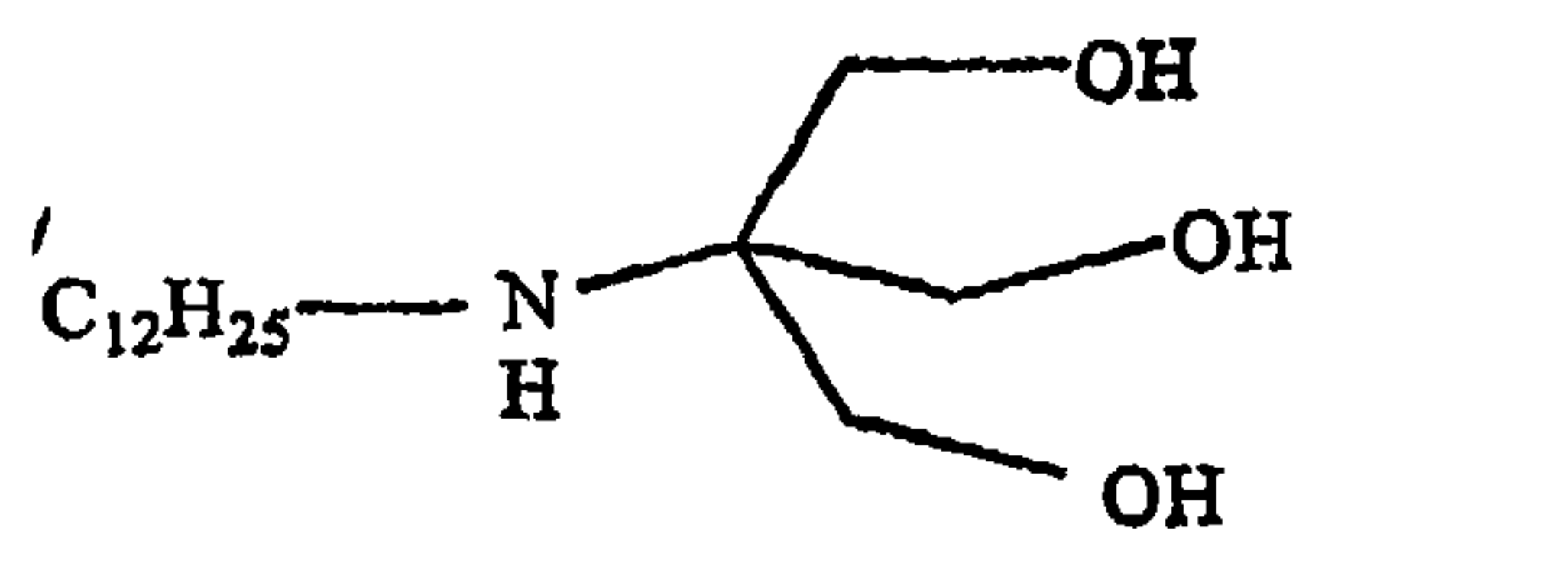
DDD	 <p style="text-align: center;">EO=9</p>	6916412
EEE		6747783
FFF		6788460
GGG	$C_{12}H_{25} \text{ --- } (OCH_2CH_2)_4NHCH_3$	6566722
HHH	$C_{12}H_{25} \text{ --- } (OCH_2CH_2)_4N(CH_3)_2$	6747786
III	$C_{16}H_{33} \text{ --- } (EO)_{10}N(CH_3)_2$	6866748
JJJ	$(\text{tallow}) \text{ --- } (PO)_2(EO)_9N(CH_3)_2$	6866733
KKK	$(C_{16}H_{33}) \text{ --- } (OCH_2CH_2)_{10}NH(CH_2)_3NH_2$	6866729

64725-903 (D)

119

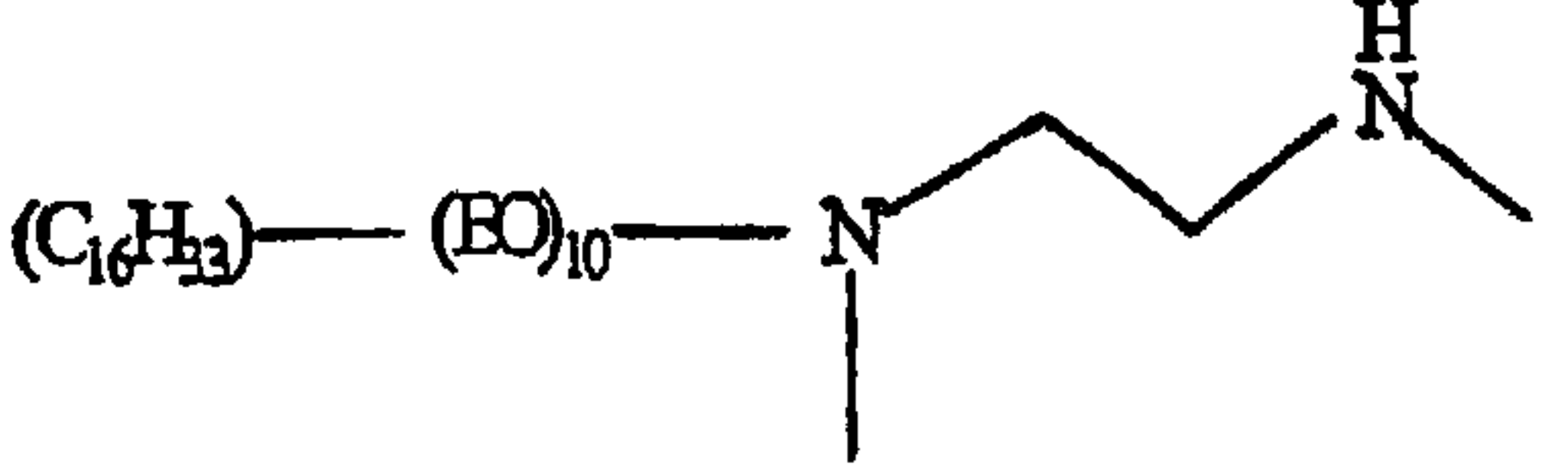
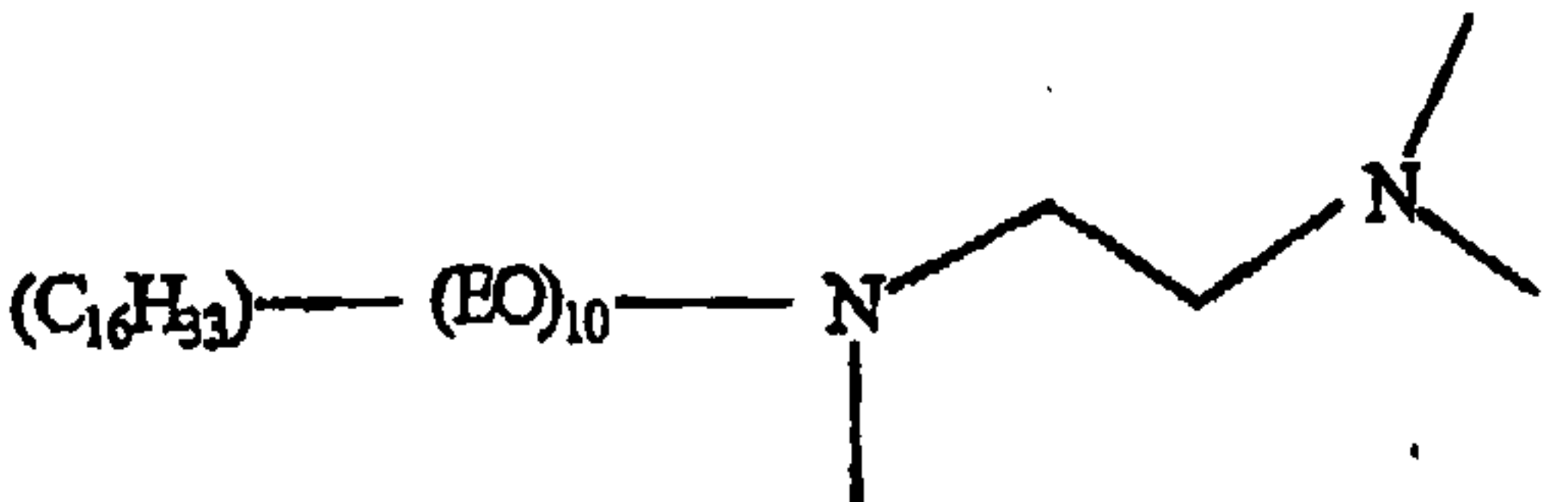
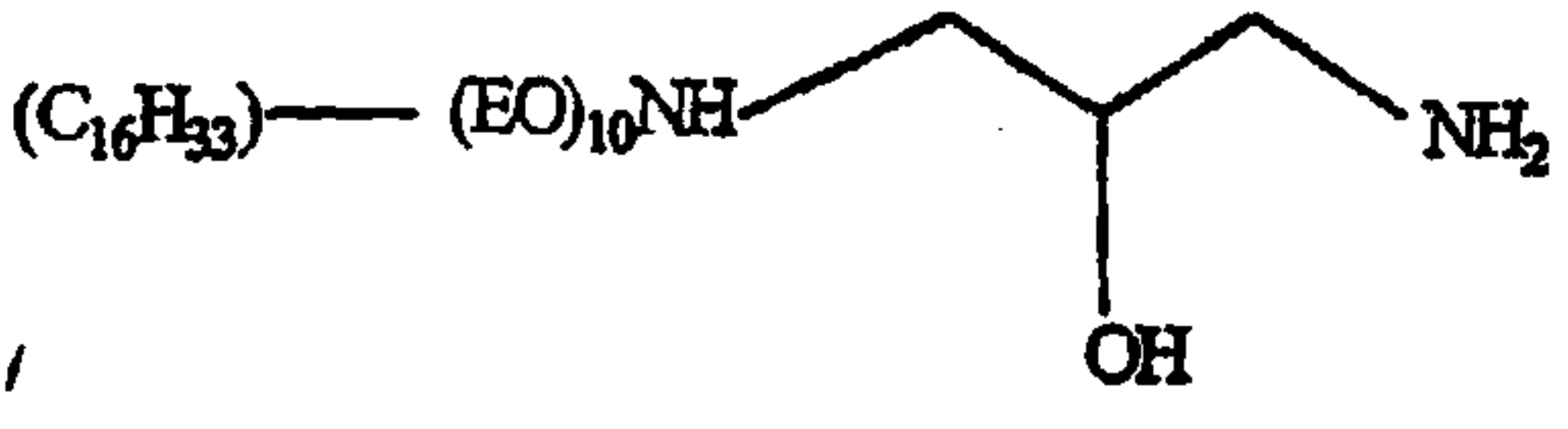
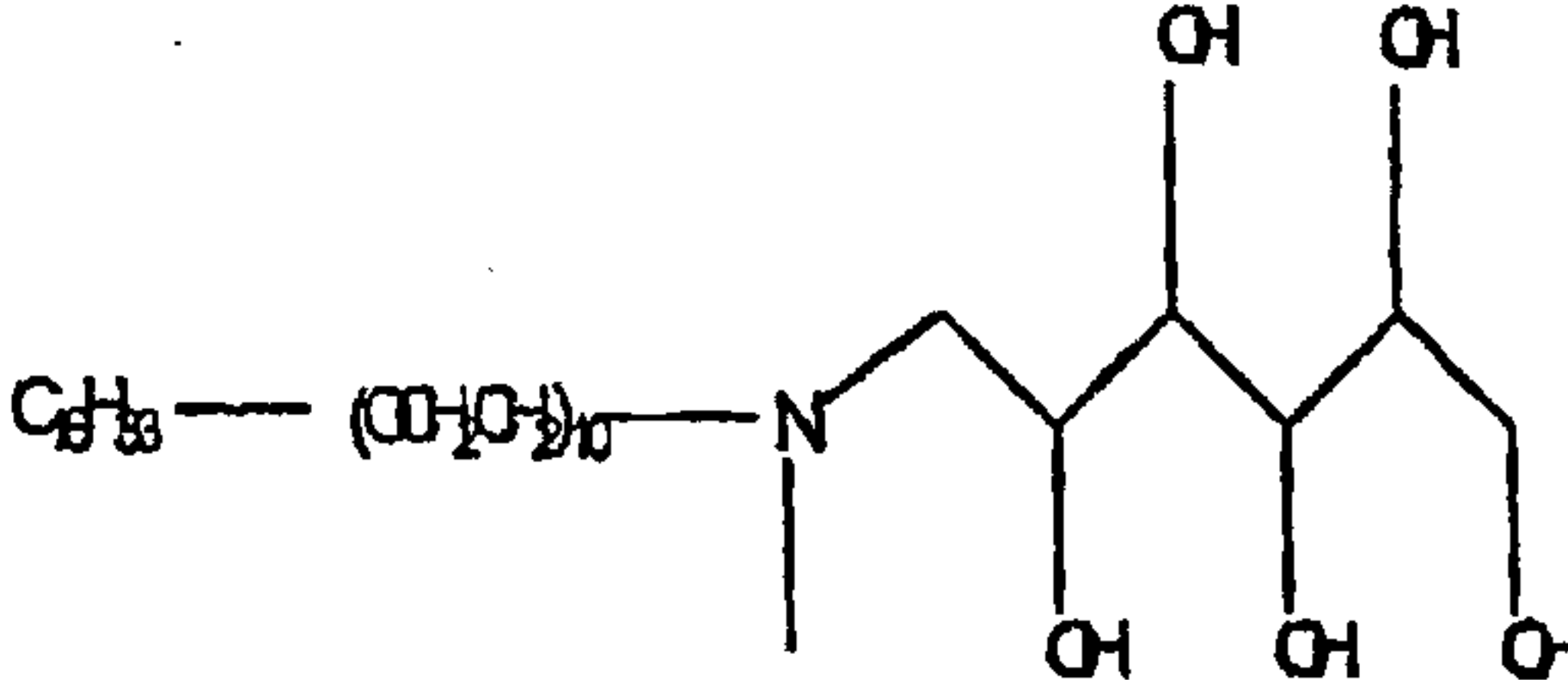
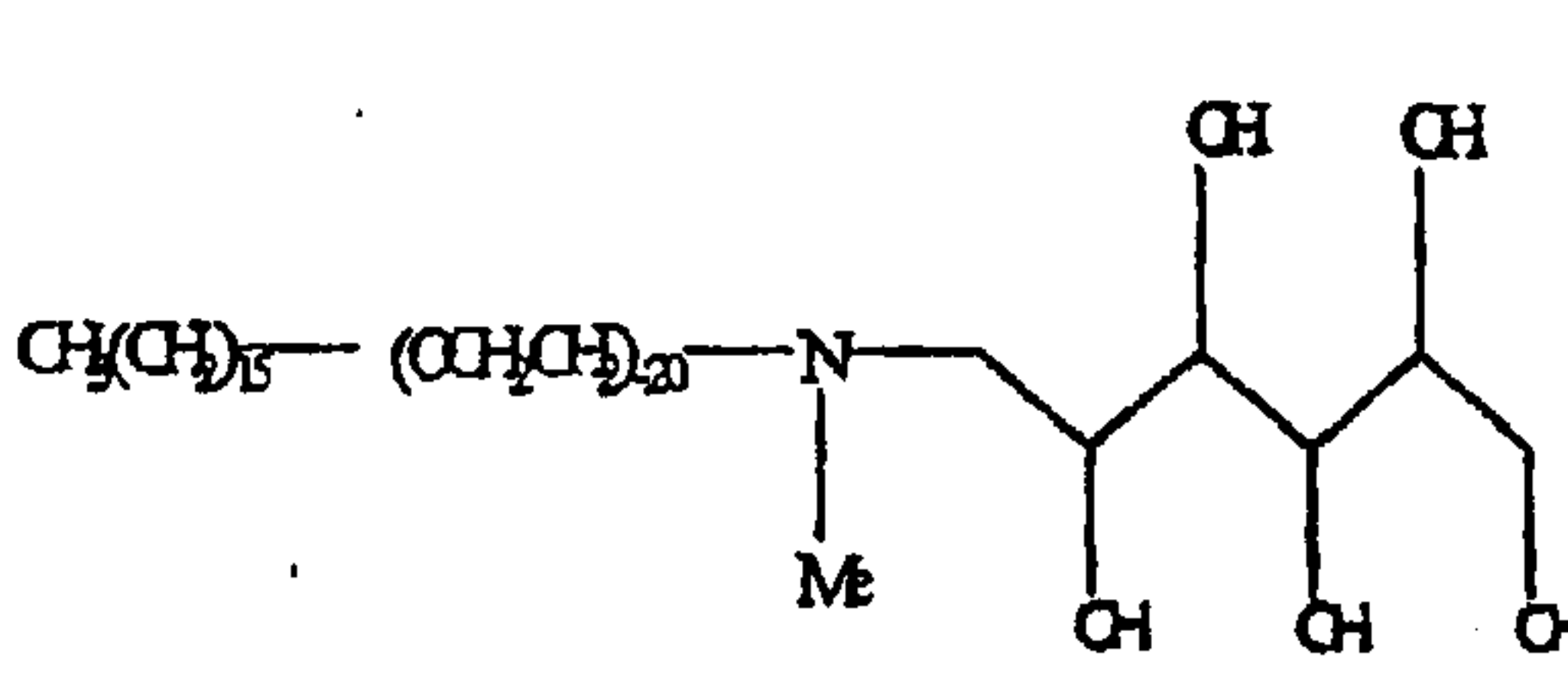
LLL		6866759
MMM		6866758
NNN		
OOO		6866730
PPP		6866782

64725-903 (D)

120

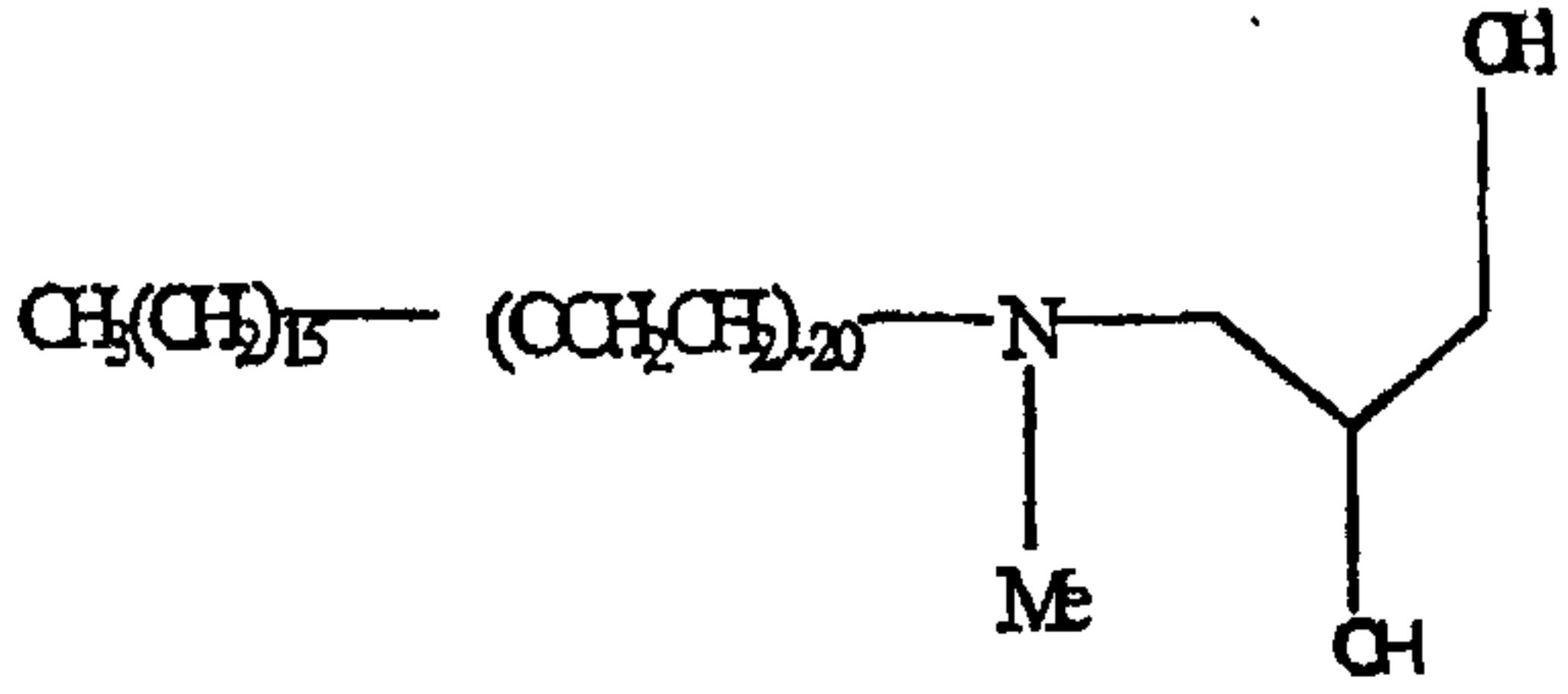
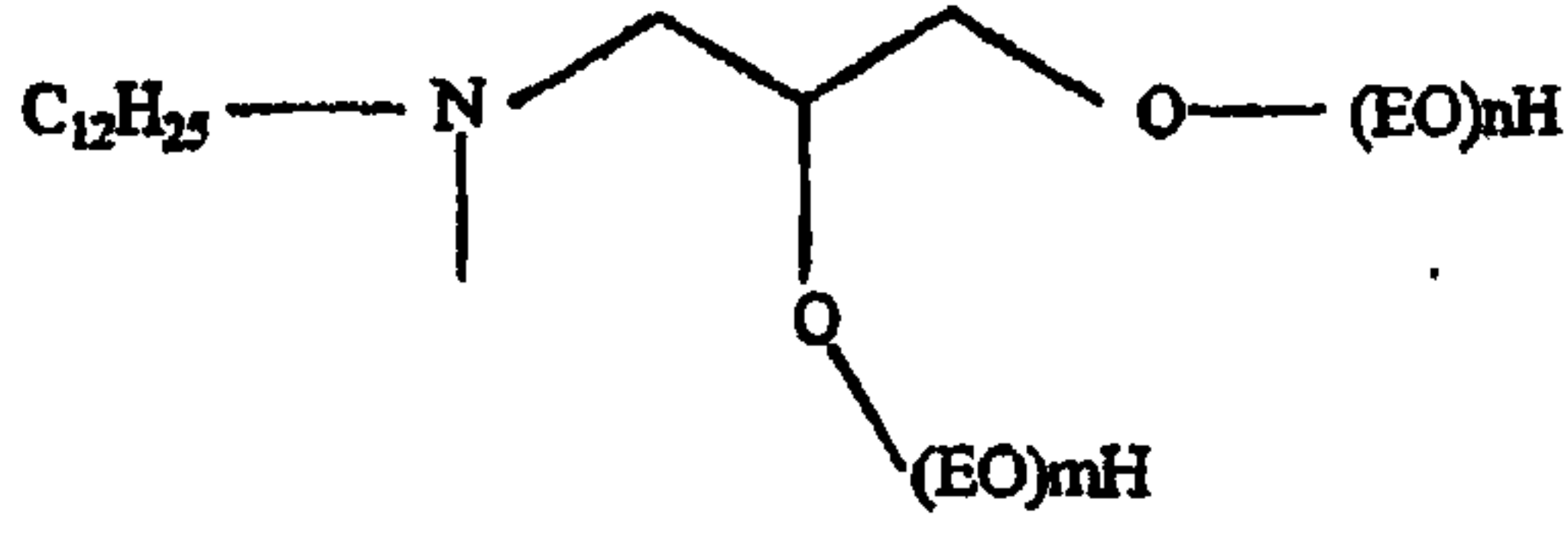
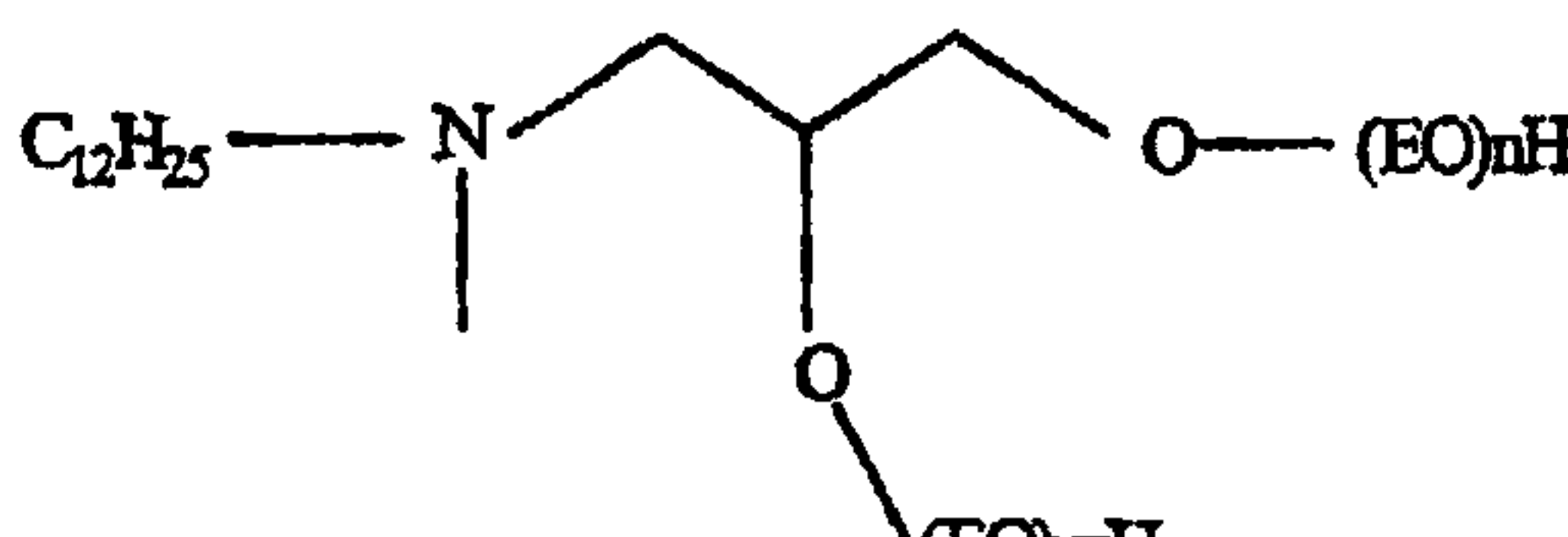
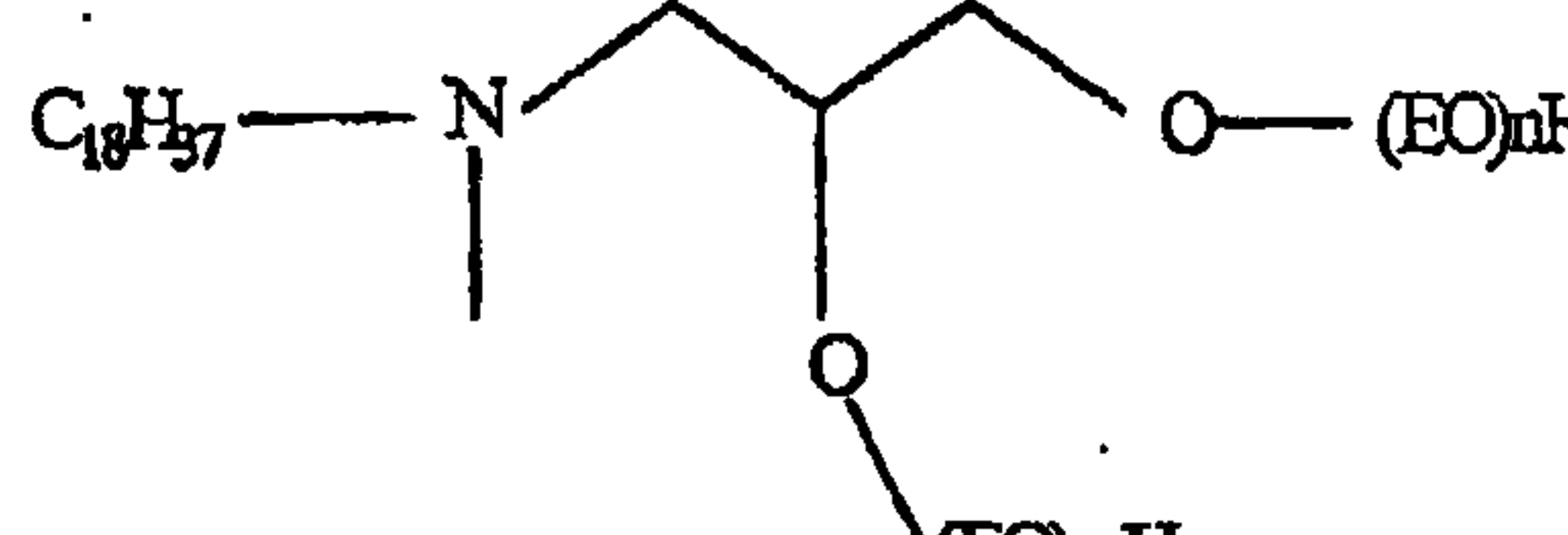
QQQ	 $\text{CH}_3(\text{CH}_2)_5 - (\text{OCH}_2\text{CH}_2)_{20} - \text{N}(\text{Me}) - \text{CH}_2 - \text{CH}(\text{OH}) - \text{CH}_2\text{OH}$	6866787
RRR	 $\text{C}_{12}\text{H}_{25} - \text{N}(\text{Me}) - \text{CH}_2 - \text{CH}(\text{O}(\text{EO})_m\text{H}) - \text{CH}_2 - \text{O}(\text{EO})_n\text{H}$ <p style="text-align: center;">$m+n=5$</p>	6801387
SSS	 $\text{C}_{12}\text{H}_{25} - \text{N}(\text{Me}) - \text{CH}_2 - \text{CH}(\text{O}(\text{EO})_m\text{H}) - \text{CH}_2 - \text{O}(\text{EO})_n\text{H}$ <p style="text-align: center;">$m+n=10$</p>	6801389
TTT	 $\text{C}_{18}\text{H}_{37} - \text{N}(\text{Me}) - \text{CH}_2 - \text{CH}(\text{O}(\text{EO})_m\text{H}) - \text{CH}_2 - \text{O}(\text{EO})_n\text{H}$ <p style="text-align: center;">$m+n=5$</p>	6801384

64725-903 (D)

121

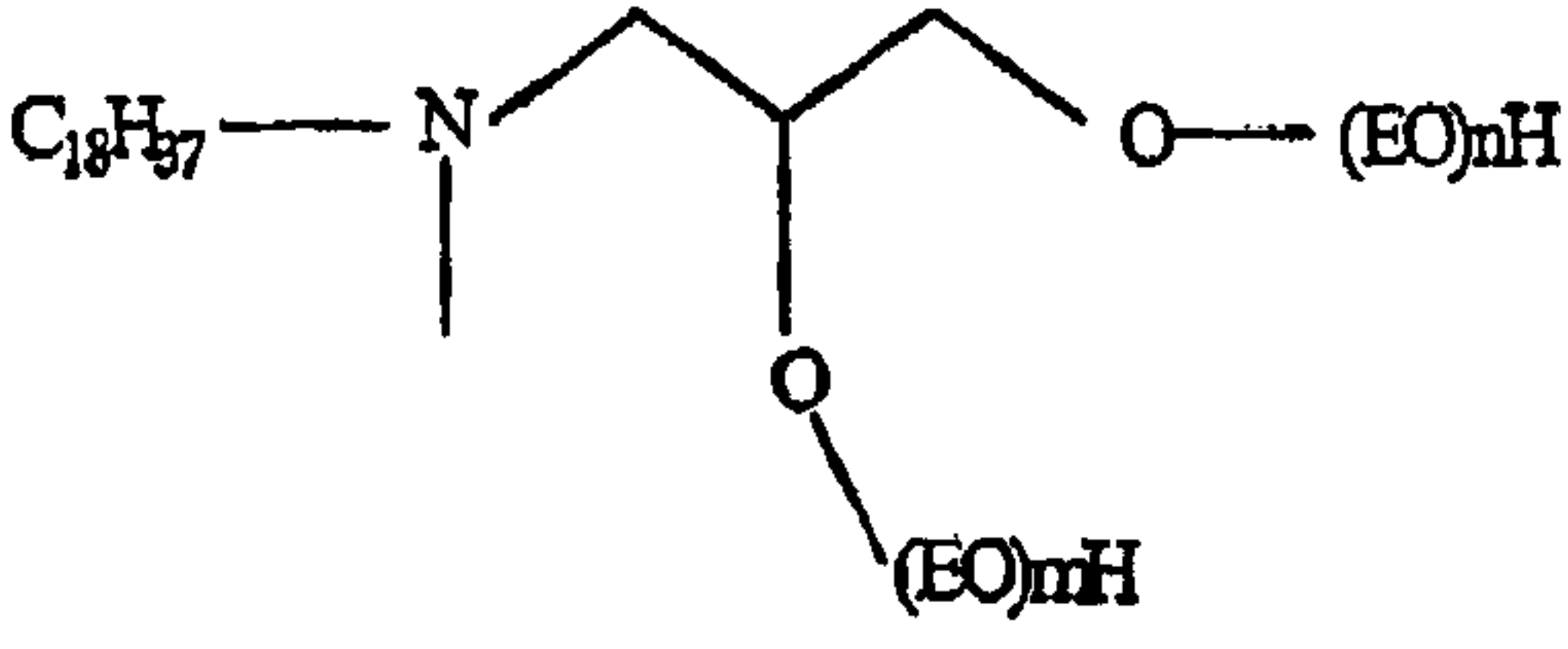
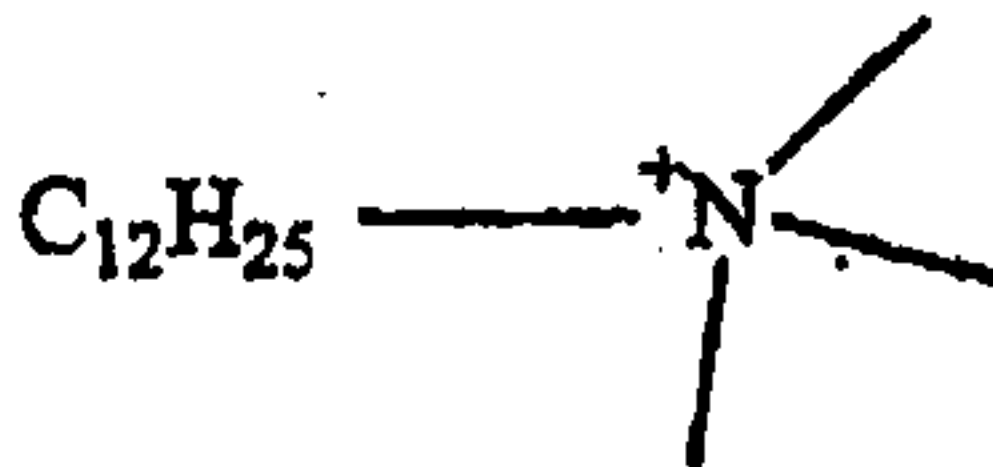
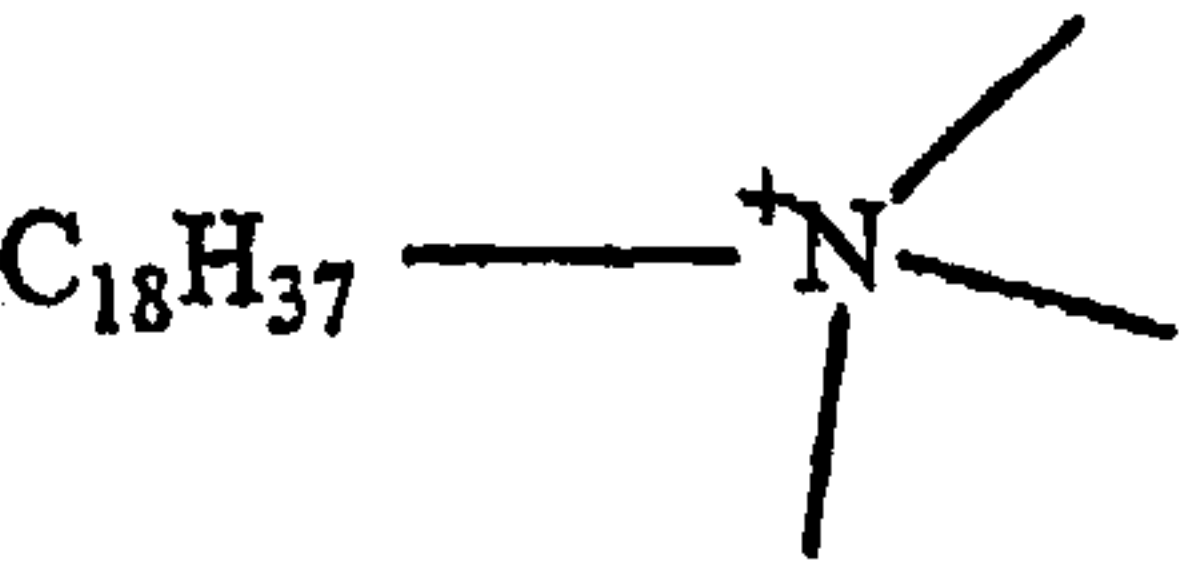
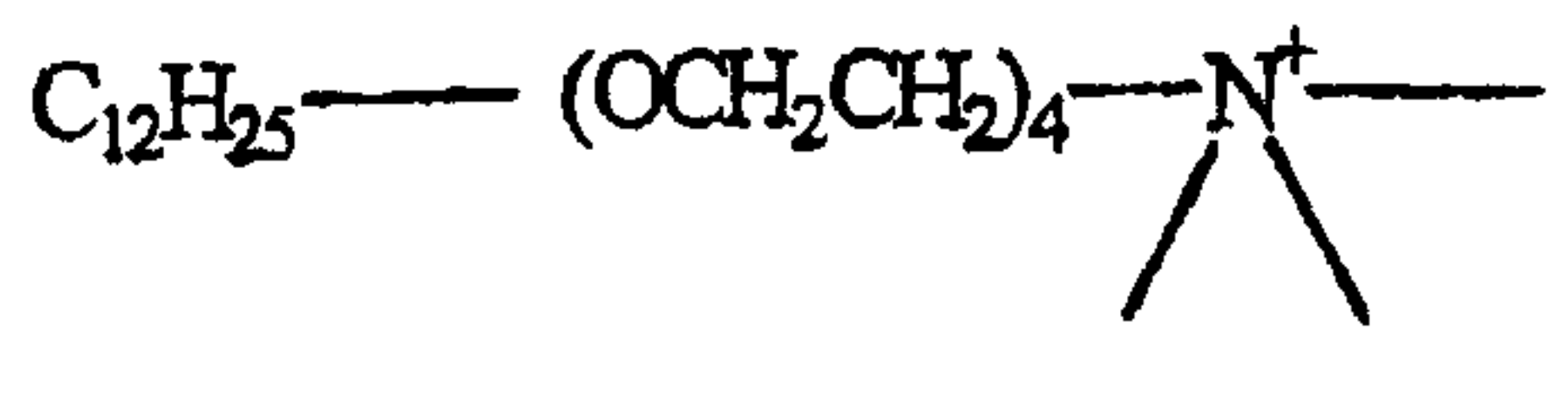
UUU	 <p style="text-align: center;">$m+n=10$</p>	6801388
VVV	<p style="text-align: center;">Cl^-</p> 	
<p>The following compounds were not compatible with 31% a.e. potassium glyphosate and 10% surfactant, but were compatible with 31% a.e. diammonium glyphosate and 10% surfactant:</p>		
WWW	<p style="text-align: center;">Cl^-</p> 	
XXX	<p style="text-align: center;">Cl^-</p> 	

Example C Preparation of Representative Sample Compositions of the Invention

For the 31 wt.% a.e. potassium glyphosate/10 wt.% surfactant compositions: 1.550g of 40 wt.% a.e. aqueous glyphosate potassium salt solution was weighed into a vial. To the same vial, 0.200 g of surfactant was added. Enough deionized water was then added to the

64725-903 (D)

122

contents to bring the total weight to 2.000g. The mixture was stirred for 2 hours at room temperature and checked to see if a solution had been formed. If a solution was present, the test vial was allowed to stand at room temperature overnight. If a solution was still present, the test vial was placed in a 50°C oven for 1 week. If no phase separation had occurred in one week, the surfactant being tested was considered "compatible." All of the surfactants identified in Table 4 were compatible at the 31% a.e. potassium/10 wt.% surfactant loading.

For the 37 wt.% a.e. potassium glyphosate/12 wt.% surfactant compositions: 41.1g of 45 wt.% a.e. aqueous glyphosate potassium salt was weighed to a container. To the same container was added 6.0g of surfactant and 2.9g deionized water for a total weight of 50.0g. The remainder of the protocol is the same as that described for the 31 wt.% samples. The surfactants identified in Table 4 that were compatible at the 37% a.e. potassium/12 wt.% surfactant loading are indicated in Table 5 below.

64725-903 (D)

123

For the 40 wt.% a.e. potassium glyphosate/10 wt.% surfactant compositions: 1.79g of 45 wt.% a.e. aqueous glyphosate potassium salt was weighed into a vial. To the same vial was added 0.2 g of surfactant. The remainder of the protocol is the same as that described for the 31 wt.% samples. The surfactants identified in Table 4 that were compatible at the 40% a.e. potassium/10 wt.% surfactant loading are indicated in Table 5 below.

For the 45 wt.% a.e. potassium glyphosate/15 wt.% surfactant compositions: 1.100g of solid mono potassium glyphosate was weighed into a vial. To the same vial was added 0.300g surfactant. Enough deionized water was added to the vial to bring the final weight to 2.000g. The remainder of the protocol is the same as that described for the 31 wt.% samples. The surfactants identified in Table 4 that were compatible at the 45% a.e. potassium/10 wt.% surfactant loading are indicated in Table 5 below.

64725-903 (D)

124

For the 31 wt.% a.e. NH_4^+ glyphosate/10 wt.% surfactant compositions:

1.48g of 41.9 wt % a.e. aqueous glyphosate diammonium (1.7 eq) salt was weighed into a vial. To the same vial was added 0.2g of surfactant and 0.32g deionized water. The remainder of the protocol is the same as that described for the 31 wt % potassium glyphosate samples. The surfactants identified in Table 4 that were compatible at the 31% a.e. ammonium/10 wt.% surfactant loading are indicated in Table 5 below.

For the 37 wt.% a.e. NH_4^+ glyphosate/12 wt.% surfactant compositions:

1.76g of 41.9 wt % a.e. aqueous glyphosate diammonium (1.7 eq) salt was weighed into a vial. To the same vial was added 0.2g of surfactant. The remainder of the protocol is the same as that described for the 31 wt % potassium glyphosate samples. The surfactants identified in Table 4 that were compatible at the 37% a.e. ammonium/12 wt.% surfactant loading are indicated in Table 5 below.

Compatibility and viscosity data are listed for selected compositions of Example C in Table 5. It is understood that not all results of all compatibility tests are reported herein. Several surfactants tested (but not reported herein) were not compatible even at the 31 wt.% a.e. loading.

Example D: Preparation of α -methyl- ω -(N-methyloctadecylamino)poly(oxy-1,2-ethanediyl)

Preparation of Intermediate for Compound C of Table 4

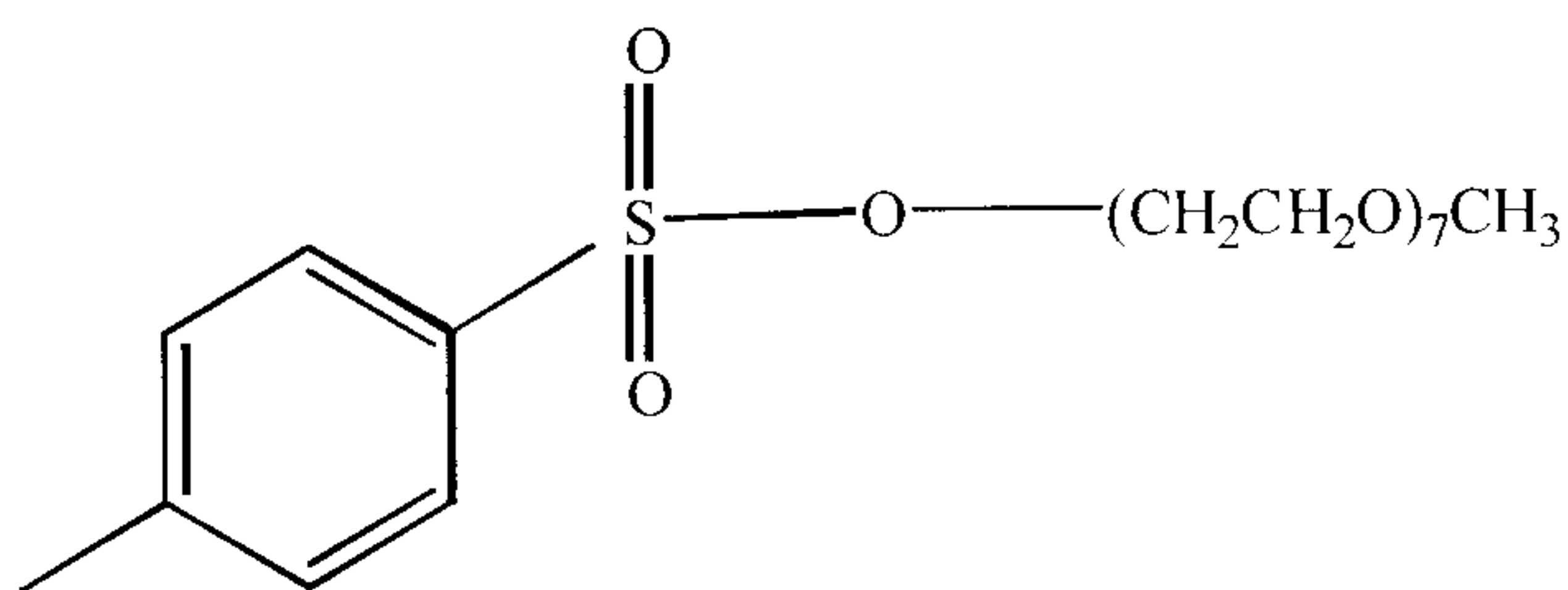

(90)

Hepta(oxyethylene)glycol methyl ether tosylate (I):

Hepta(oxyethylene)glycol methyl ether (350 MW avg., 47 g, 1 eq., Aldrich) and triethylamine (17.59 g, 1.3 eq.) were dissolved in anhydrous methylene chloride (20 ml) and placed under a nitrogen atmosphere. p-Toluenesulfonyl chloride (28.16 g, 1.1 eq.) dissolved in anhydrous methylene chloride (20 ml) was added slowly, keeping the temperature below 10°C. After stirring for 4 hours at room temperature, the reaction mixture was filtered, and the solvent was removed from the filtrate under reduced pressure to give 64 g of an orange oil, 95% yield. ¹H NMR d 7.8 (d, 2H), 7.5 (d, 2H), 4.1 (t, 2H), 3.6-3.4 (m, 26H), 3.2 (s, 3H), 2.4 (s, 3H).

Preparation of Compound C of Table 4:

N-methyloctadecyl amine (283 MW, 18.49g, 2.2eq.) was dissolved in 200 ml of toluene and then potassium carbonate (4.1g, 1eq.) was added. The tosylate (I) (15g, 1 eq.) was slowly added to the mixture and then the reaction was placed under nitrogen and heated overnight at 80°C. Solids were removed from the completed reaction by filtering over celite. Toluene was removed from the filtrate under reduced pressure. The

64725-903 (D)

126

crude product was chromatographed using methylene chloride/methanol/ammonium hydroxide in the ratio 80:5:1. 16g of yellow semi-solid (II) was obtained, yield 85%. H NMR, 3.6-3.4p(m, 26H), 3.3p(s, 3H), 2.6p(t, 2H), 2.4p(t, 2H), 2.2p(s, 3H), 1.4p(m, 2H), 1.2p(s, 30H), 0.8p(t, 3H).

Table 5. Compatibility and Viscosity Data for Selected 37 wt. % a.e., 40 wt. % a.e. and 45 wt. % a.e. compositions of Example 3.

Surfactant	Compatible w/37% a.e. K+glyphosate at 12wt%loading	Viscosity Data 37% a.e. K+glyphosate at 12wt%loading	Cloud Point Data 37% a.e. K+glyphosate at 12wt%loading	Compatible w/40% a.e. K+glyphosate at 10%wtloading	Compatible w/45% a.e. K+glyphosate at 15%wtloading	Compatible w/31% a.e. diammonium glyphosate at 10wt%loading	Compatible w/37% a.e. diammonium glyphosate at 12wt%loading
C						No	
F	Yes	Haake Vis. 25°C 57.29cPs 15°C 110.89cPs 10°C 142.38cPs 5°C 173.57cPs 0°C 273.01cPs -5°C 400.48cPs	>90°C	Yes	Yes		
J	Yes	frozen at 10°C	n.a.				
O	Yes	Haake Vis. 25°C 101.82cPs 15°C 118.51cPs 10°C 198.34cPs 5°C 221.90cPs 0°C 467.60cPs	>90°C				

128

R	Yes	Haake Vis. 25°C 1077cPs 15°C 1420cPs 10°C 1963cPs 5°C 2269cPs 0°C 2517cPs -5°C, too thick	>90°C	Yes	No (Gel)	Yes	Yes
W	Yes	Haake Vis. 25°C 31.49cPs 15°C 64.15cPs 10°C 76cPs 5°C 96.58cPs 0°C 146.77cPs -5°C 164.23cPs	>90°C	Yes	No (Gel)	Yes	Yes
AA	Yes	Brookfield Viscosity 10°C, Spindle 31 60rpm, 60.1cPs 12rpm, 52.6cPs	>90°C	Yes	Yes	Yes	Yes
CC	Yes	Haake Vis. 25°C 115.18cPs 15°C 162.06cPs 10°C 274.66cPs 5°C 358.87cPs 0°C 384.53cPs -5°C 646.90cPs	>90°C	Yes	No	Yes	Yes

64725-903(D)

DD	Yes	Haake Vis. 25°C 49.37cPs 15°C 82.51cPs 10°C 138.80cPs 5°C 150.26cPs 0°C 231.17cPs -5°C 397.16cPs	>90°C						
EE	Yes	Brookfield Vis. 10°C, Spindle 31 60rpm, too thick 12rpm, 1420cp	40°C						
PP	Yes	Brookfield Vis. 10°C, Spindle 31 60rpm, 50.1cp 12rpm, 37.6cp	64°C						
RR	Yes						Yes	Yes	Yes
SS	Yes	Brookfield Vis. 10°C, Spindle 31 60rpm, 88.2cp 12rpm, 86.5cp					Yes, but initially a gel that became flowable	No	No

64725-903 (D)

UU	Yes	Brookfield Vis. 10°C, Spindle 31 60rpm, 113cp 12rpm, 114cp				No	No
VV	Yes	Brookfield Vis. 10°C, Spindle 31 60rpm, 103cp 12rpm, 107cp	Yes			Yes	Yes
XX	No					Yes	No
YY	No					Yes	No
ZZ	Yes		Yes				
AAA	Yes	Brookfield Vis. 10°C, Spindle 31 60rpm, 78.2cp 12rpm, 76.5cp	Yes			Yes	Yes
CCC	Yes		Yes				
DDD						No	No

64725-903 (D)

EEE	Yes			No	Yes	Yes
FFF					No (gel)	No (gel)
HHH					No (gel)	
KKK	Probably yes, but ambiguous due to minor solids			Yes, but minor solids present, initially a gel that became flowable		
MMM	Yes				Yes (very thick)	
OOO	Probably yes, but ambiguous due to minor solids				No (gel)	Yes

64725-903(D)

PPP	No						No	No
QQQ	No						No	No
RRR	Yes			-			No	No
TTT	Yes (minor solids)						No	
VVV							Yes	No (gel)
WWW							Yes	No (gel)
XXX	No						Yes	No

64725-903 (D)

133

It will be noted that the compositions of the invention containing glyphosate potassium salt without alkylpolyglycoside as a component of the surfactant system generally have significantly lower viscosity than similarly loaded glyphosate potassium salt compositions containing APG. The magnitude of this viscosity advantage depends to some extent on the choice and concentration of the particular surfactant(s) employed. For example, the preceding description of specific embodiments of the present invention is not intended to be a complete list of every possible embodiment of the invention. Persons skilled in this field will recognize that modifications can be made to the specific embodiments described here that remain within the scope of the present invention.

Example E. Preparation of Surfactants RRR-UUU

Compounds of the formulae (36) or (37) were prepared

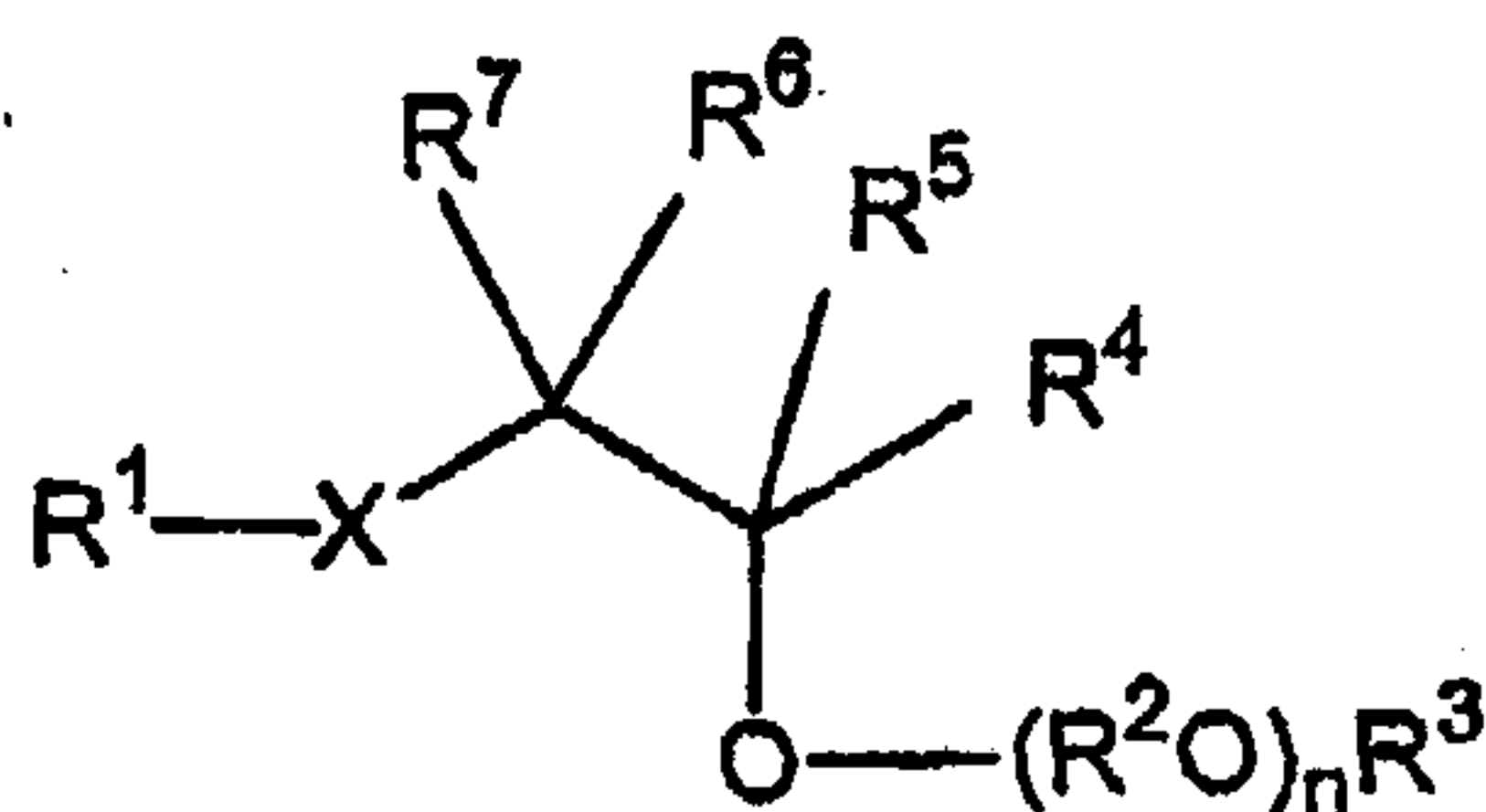

(36)

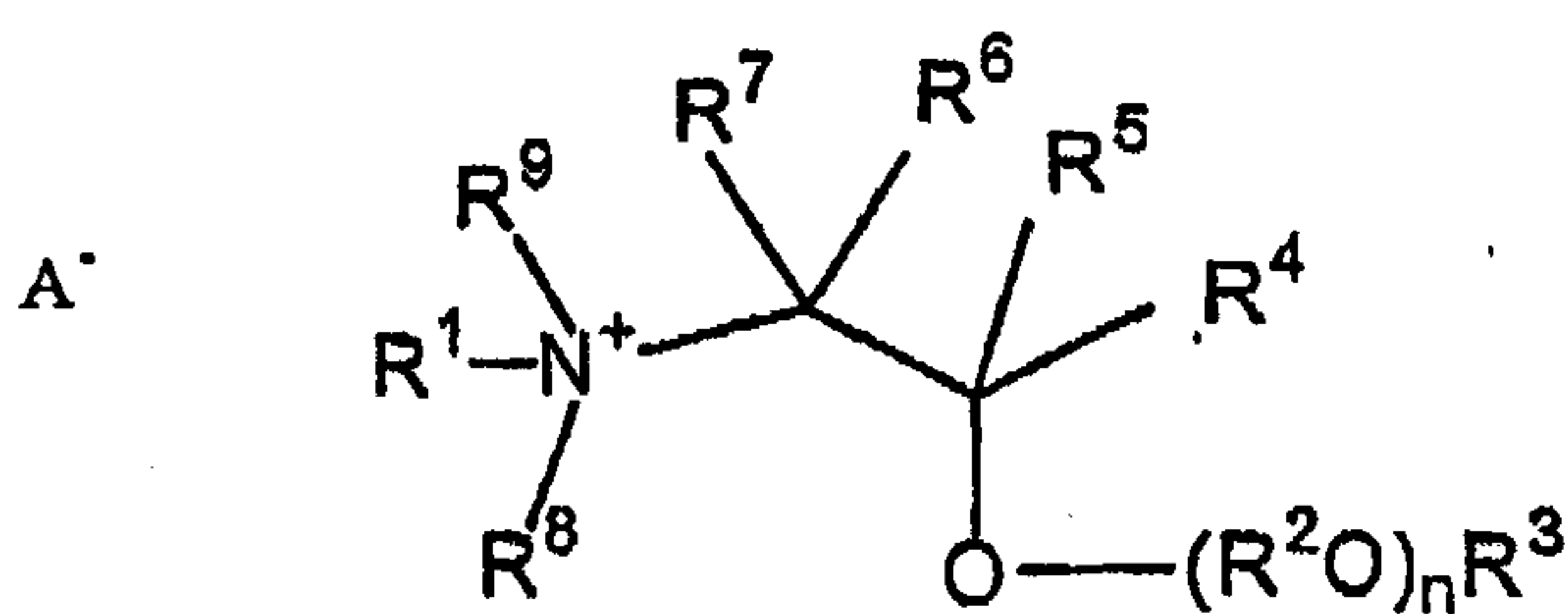

(37)

64725-903 (D)

134

wherein R^1 , and R^9 are independently hydrocarbyl or substituted hydrocarbyl having from 1 to about 30 carbon atoms, or $-(R^2O)_pR^{13}$; R^2 in each of the m (R^2O), n (R^2O), p (R^2O) and q (R^2O) groups is independently C_2-C_4 alkylene; R^3 , R^8 , R^{13} and R^{15} are independently hydrogen, or a hydrocarbyl or substituted hydrocarbyl having from 1 to about 30 carbon atoms; R^4 is $-(CH_2)_yOR^{13}$ or $-(CH_2)_yO(R^2O)_qR^3$; R^5 , R^6 and R^7 are independently hydrogen, hydrocarbyl or substituted hydrocarbyl having from 1 to about 30 carbon atoms, or R^4 ; R^{14} is hydrocarbyl or substituted hydrocarbyl having from 1 to about 30 carbon atoms, or $-(CH_2)_zO(R^2O)_pR^3$; m , n , p and q are independently an average number from 1 to about 50; X is $-O-$, $-N(R^{14})-$, $-C(O)-$, $-C(O)O-$, $-OC(O)-$, $-N(R^{15})C(O)-$, $-C(O)N(R^{15})-$, $-S-$, $-SO-$, or $-SO_2-$; t is 0 or 1; A^- is an agriculturally acceptable anion; and y and z are independently an integer from 0 to about 30.

The compound was prepared by addition of a compound R^1-XH to an epoxide in a 1:1 molar ratio in the presence of a base such as diisobutyl aluminum hydride (DIBAL), NaH or a Lewis acid, such as BF_3Et_2O , to form intermediate (91) as represented in the reaction scheme shown below:

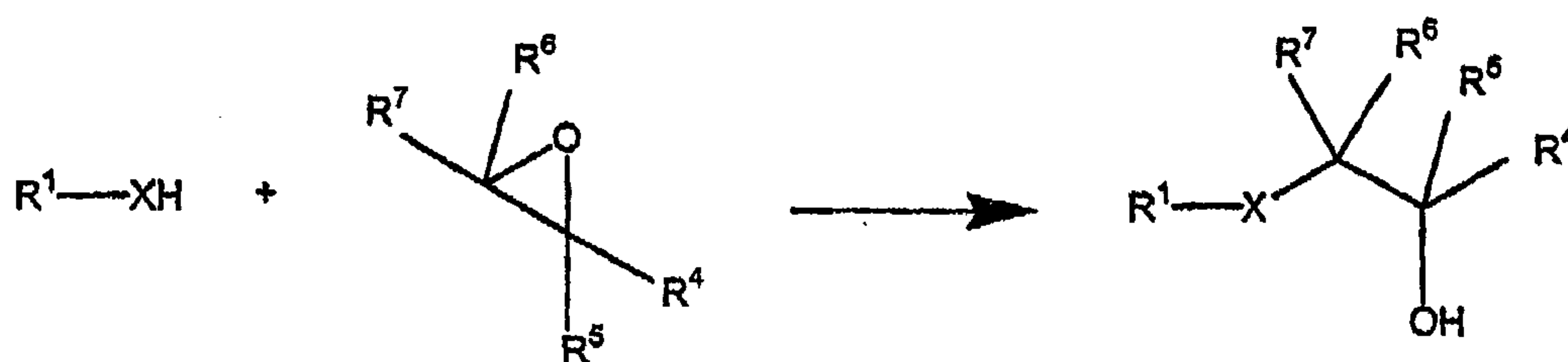

(91)

The compound (91) is then alkoxyated via conventional means to form a compound of formula (36). When X is $-N^+R^8R^9-$ in the above reaction scheme, compound (37) is formed.

Alkyl aminopropanediol compounds having the formula (36) were prepared, wherein X is $-N(R^{14})-$, R^3 , R^5 , R^6 and R^7 are hydrogen, R^2O is ethylene, and R^4 is $-CH_2O(R^2O)_qR^3$. Ethylene oxide was used for the alkoxylation.

64725-903 (D)

135

TABLE 6

Compound	R ₁	R ₁₄	n + q	Formulation
1a	C ₁₈ H ₃₇	CH ₃	5	384
1b	C ₁₈ H ₃₇	CH ₃	10	388
1c	C ₁₈ H ₃₇	CH ₃	15	409
1d	C ₁₈ H ₃₇	CH ₃	20	415
1e	C ₁₈ H ₃₇	CH ₃	25	416
1f	C ₁₂ H ₂₅	CH ₃	5	387
1g	C ₁₂ H ₂₅	CH ₃	10	389
1h	tallow	H	15	421
1i	tallow	H	23	423
1j	tallow	H	27	427
1k	coco	H	23	425
1l	coco	H	30	427

Alkyl aminopropanol compounds 2a-c having the formula (36), wherein X is -N(R¹⁴)-, R³, R⁵, R⁶ and R⁷ are hydrogen, R²O is ethylene, and R⁴ is -CH₂OCH₂C₆H₅, were prepared by the reaction of an amine with benzyl glycidol, followed by alkoxylation and deprotection of the benzyl group by conventional catalytic hydrogenation such that R⁴ is then -CH₂OR³. Ethylene oxide was used for the alkoxylation.

Alkyl aminopropanol compounds 2d-j having the formula (36), wherein X is -N(R¹⁴)-, R³, R⁵, R⁶ and R⁷ are hydrogen, R²O is ethylene, and R⁴ is -CH₂OR³, were prepared by the reaction of an amine with a corresponding glycidyl ether, followed by alkoxylation. Ethylene oxide was used for the alkoxylation.

64725-903 (D)

136

TABLE 7

Compound	R ₁	R ₁₄	R ₃	n	Formulation
2a	C ₁₈ H ₃₇	CH ₃	H	5	640
2b	C ₁₈ H ₃₇	CH ₃	H	10	637
2c	C ₁₂ H ₂₅	CH ₃	H	5	639
2d	C ₁₈ H ₃₇	CH ₃	CH ₃	5	
2e	C ₁₈ H ₃₇	CH ₃	CH ₃	15	
2f	C ₁₈ H ₃₇	CH ₃	CH ₃	25	
2g	C ₁₂ H ₂₅	CH ₃	CH ₃	10	481
2h	C ₁₂ H ₂₅	CH ₃	CH ₃	15	483
2i	C ₁₂ H ₂₅	CH ₃	CH ₃	25	485
2j	C ₁₈ H ₃₇	CH ₃	isopropyl	5	
2k	C ₁₈ H ₃₇	CH ₃	isopropyl	10	
2l	C ₁₂ H ₂₅	CH ₃	isopropyl	5	
2m	C ₁₂ H ₂₅	CH ₃	isopropyl	10	

Compounds (38) and (39) were prepared:

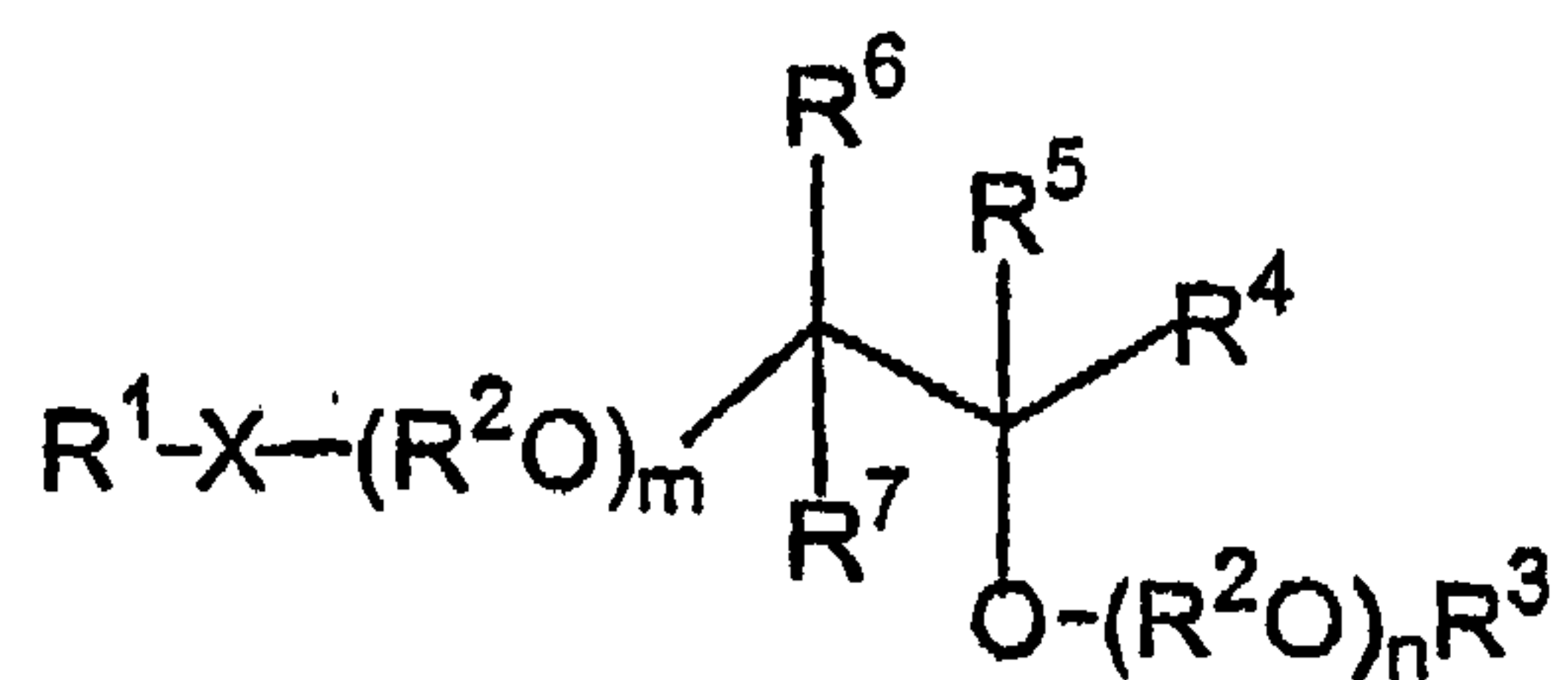

(38)

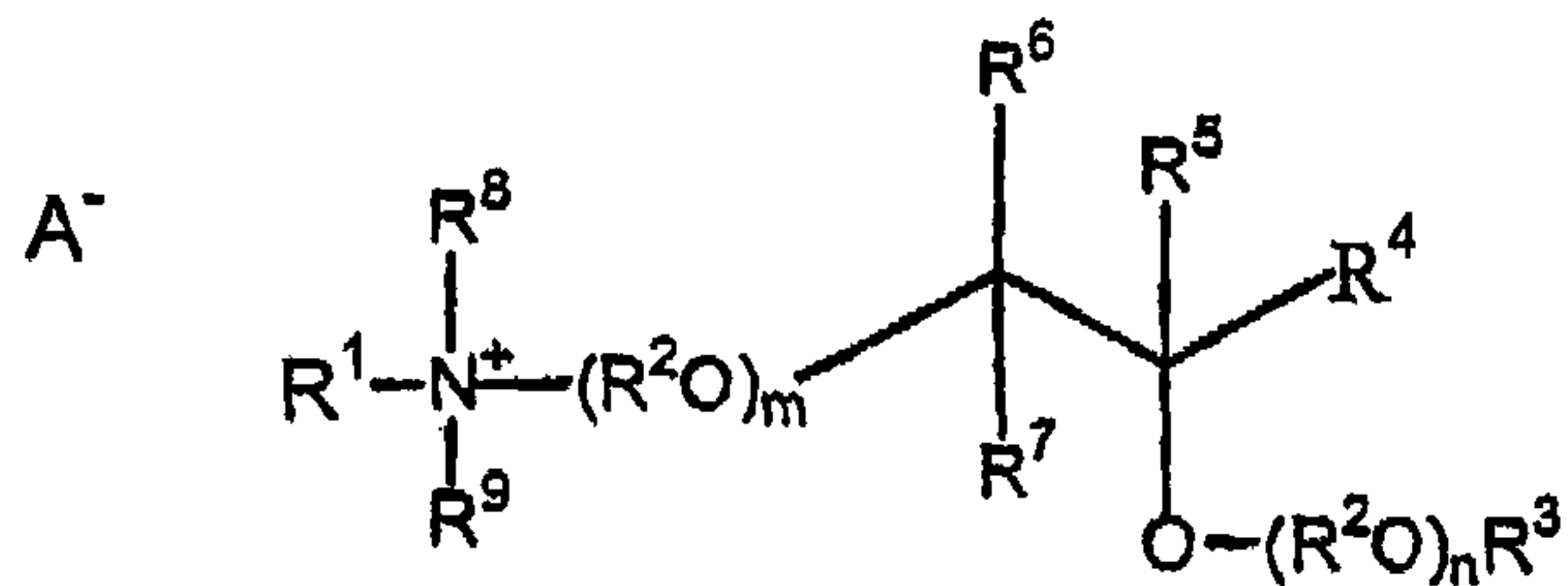

(39)

64725-903 (D)

137

wherein R^1 , and R^9 are independently hydrocarbyl or substituted hydrocarbyl having from 1 to about 30 carbon atoms, or $-(R^2O)_pR^{13}$; R^2 in each of the m (R^2O) , n (R^2O) , p (R^2O) and q (R^2O) groups is independently C_2-C_4 alkylene; R^3 , R^8 , R^{13} and R^{15} are independently hydrogen, or a hydrocarbyl or substituted hydrocarbyl having from 1 to about 30 carbon atoms; R^4 is $-(CH_2)_yOR^{13}$ or $-(CH_2)_yO(R^2O)_qR^3$; R^5 , R^6 and R^7 are independently hydrogen, hydrocarbyl or substituted hydrocarbyl having from 1 to about 30 carbon atoms, or R^4 ; R^{14} is hydrocarbyl or substituted hydrocarbyl having from 1 to about 30 carbon atoms, or $-(CH_2)_2O(R^2O)_pR^3$; m , n , p and q are independently an average number from 1 to about 50; X is $-O-$, $-N(R^{14})-$, $-C(O)-$, $-C(O)O-$, $-OC(O)-$, $-N(R^{15})C(O)-$, $-C(O)N(R^{15})-$, $-S-$, $-SO-$, or $-SO_2-$; t is 0 or 1; $A-$ is an agriculturally acceptable anion; and y and z are independently an integer from 0 to about 30.

The compound was prepared by addition of a compound R^1-XH to an epoxide in a 1:2 molar ratio in the presence of a base such as diisobutyl aluminum hydride (DIBAL), NaH or a Lewis acid, to form intermediate (92) as represented in the reaction scheme shown below:

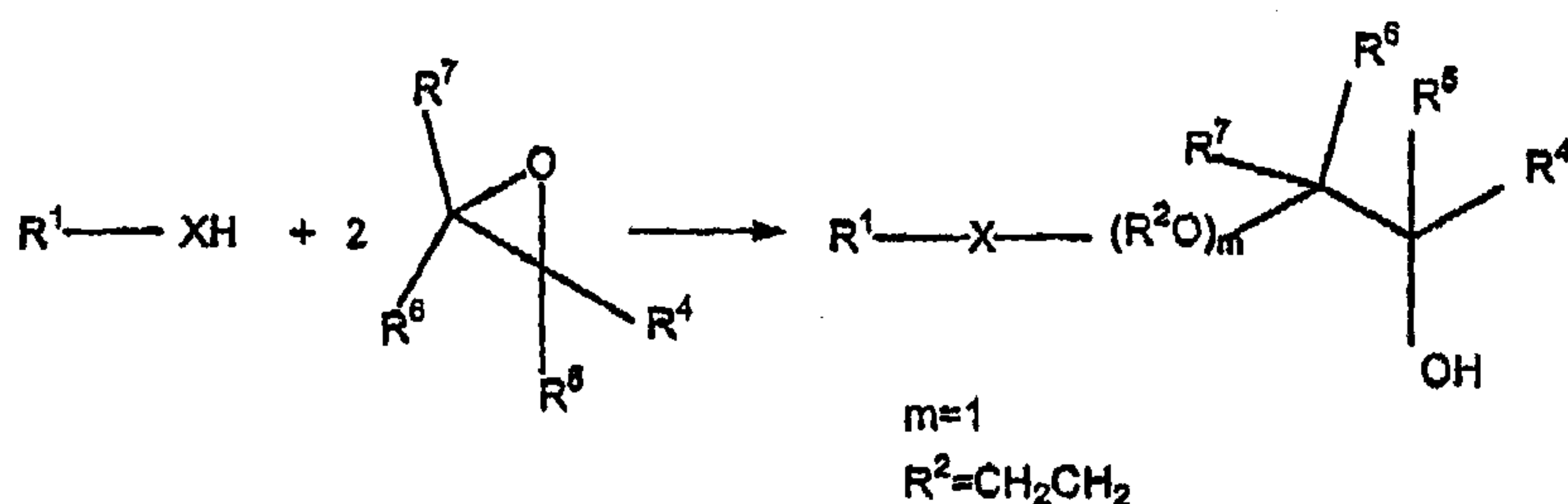

(92)

The compound (92) is then alkoxyated via conventional means to form a compound of formula (38). When X in R^1XH is $-N^+R^8R^9-$, the compound of formula (39) is formed.

The number of alkylene oxide groups formed within the main chain of compound (92) depends upon the molar ratio of compound R^1-XH to epoxide present during the reaction. If the molar ratio of compound R^1-XH to epoxide is

64725-903 (D)

138

1:3, for example, R^2 is $-\text{CH}_2\text{CH}_2-$ and m is 2 in the formula (92). The compound can then be alkoxyated as described above.

Compounds (40), (41), (42) and (43) were prepared:

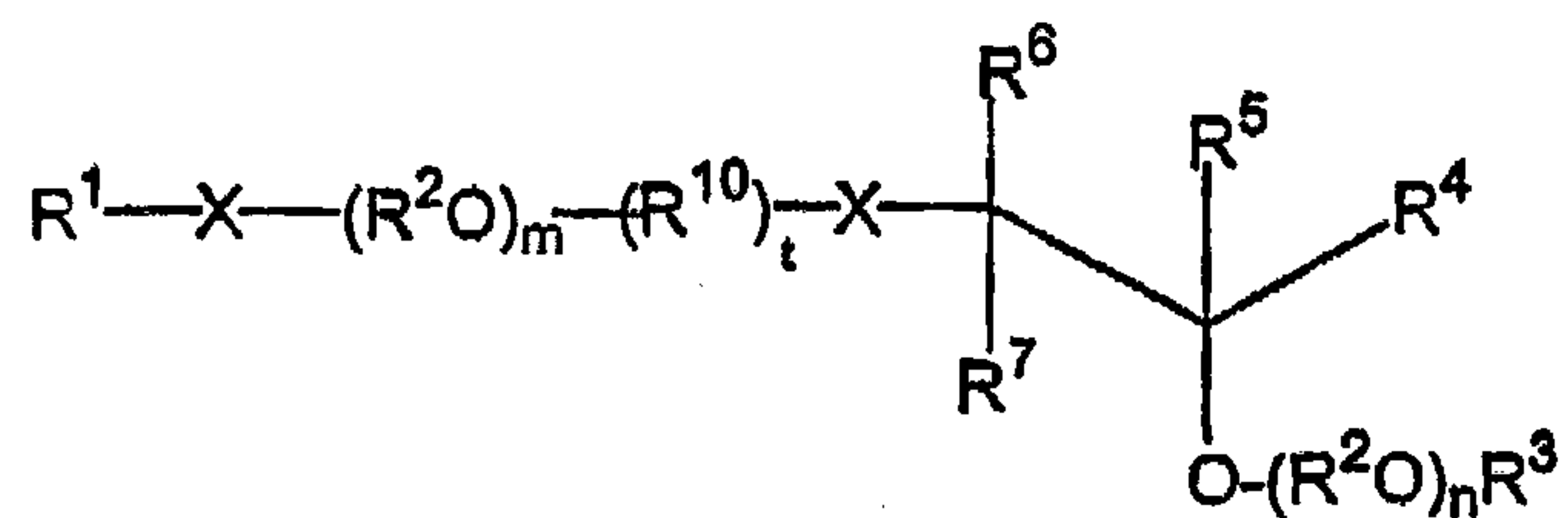

(40)

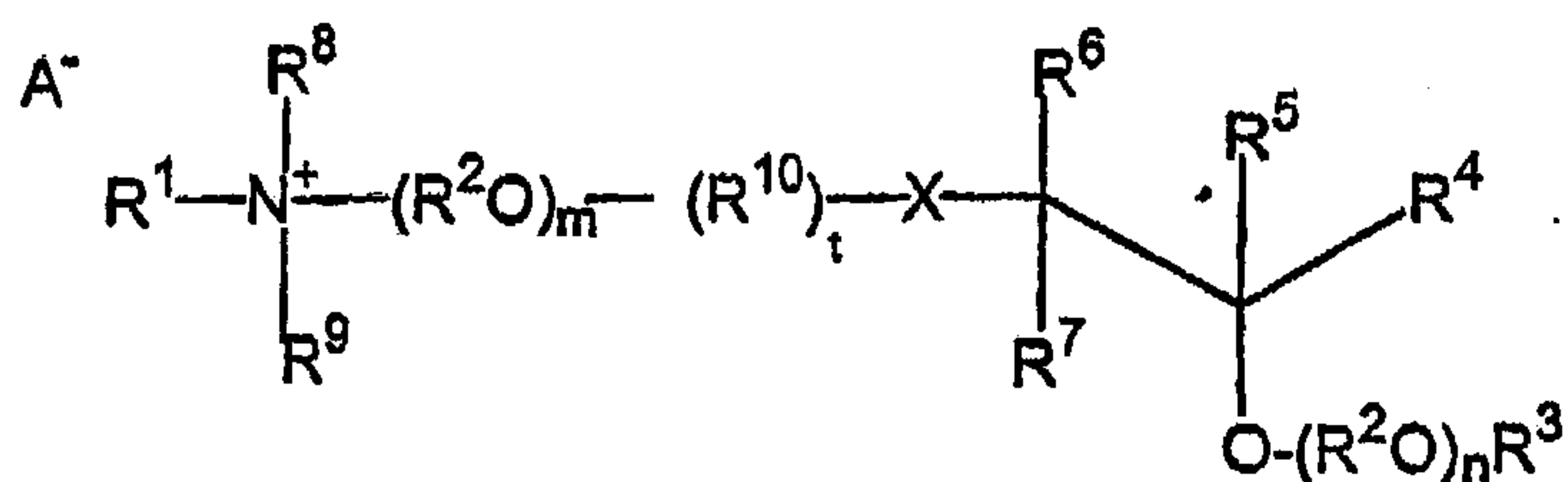

(41)

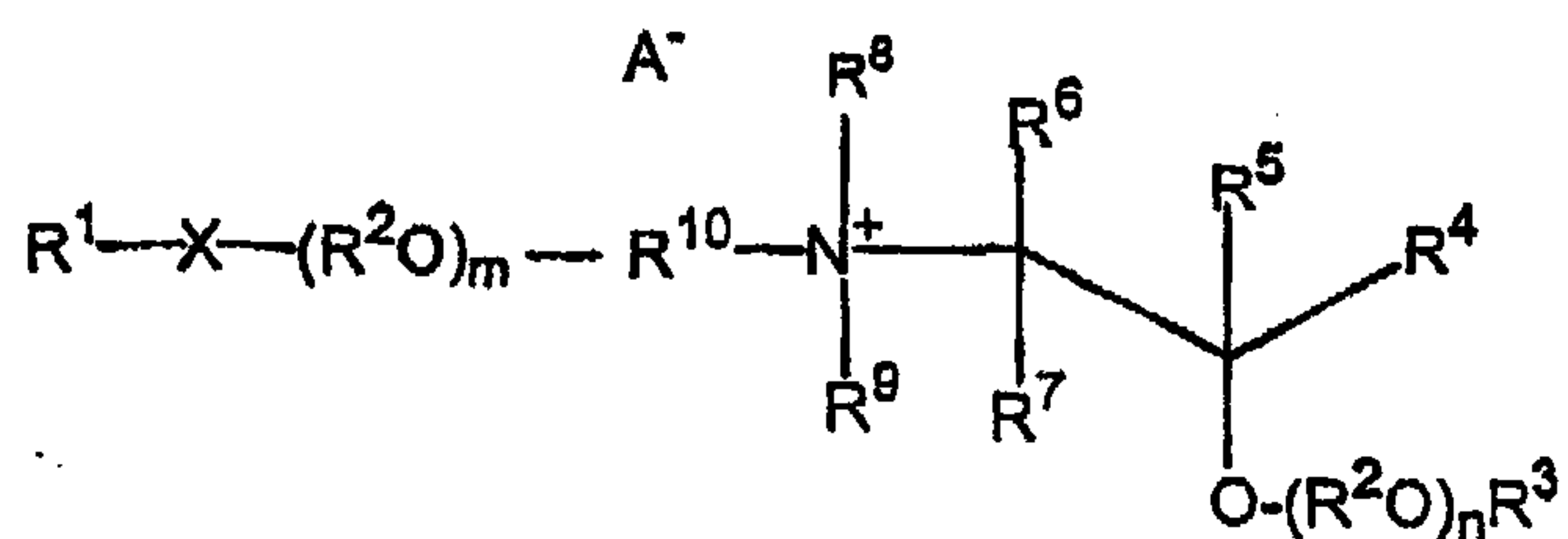

(42)

64725-903 (D)

139

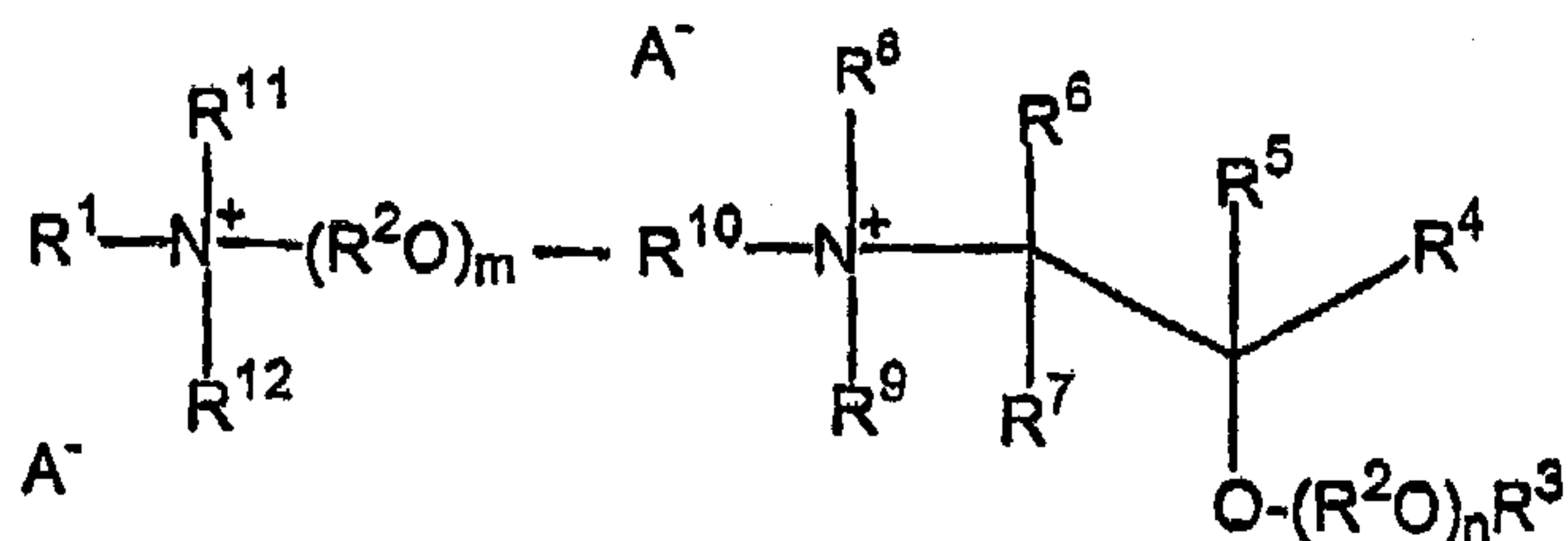

(43)

wherein R^1 , R^9 , and R^{12} are independently hydrocarbyl or substituted hydrocarbyl having from 1 to about 30 carbon atoms, or $-(\text{R}^2\text{O})_p\text{R}^{13}$; R^2 in each of the m (R^2O) , n (R^2O) , p (R^2O) and q (R^2O) groups is independently C_2 - C_4 alkylene; R^3 , R^8 , R^{11} , R^{13} and R^{15} are independently hydrogen, or a hydrocarbyl or substituted hydrocarbyl having from 1 to about 30 carbon atoms; R^4 is $-(\text{CH}_2)_y\text{OR}^{13}$ or $-(\text{CH}_2)_y\text{O}(\text{R}^2\text{O})_q\text{R}^3$; R^5 , R^6 and R^7 are independently hydrogen, hydrocarbyl or substituted hydrocarbyl having from 1 to about 30 carbon atoms, or R^4 ; R^{10} is hydrocarbylene or substituted hydrocarbylene having from 2 to about 30 carbon atoms; R^{14} is hydrocarbyl or substituted hydrocarbyl having from 1 to about 30 carbon atoms, or $-(\text{CH}_2)_z\text{O}(\text{R}^2\text{O})_p\text{R}^3$; m , n , p and q are independently an average number from 1 to about 50; X is $-\text{O}-$, $-\text{N}(\text{R}^{14})-$, $-\text{C}(\text{O})-$, $-\text{C}(\text{O})\text{O}-$, $-\text{OC}(\text{O})-$, $-\text{N}(\text{R}^{15})\text{C}(\text{O})-$, $-\text{C}(\text{O})\text{N}(\text{R}^{15})-$, $-\text{S}-$, $-\text{SO}-$, or $-\text{SO}_2-$; t is 0 or 1; A^- is an agriculturally acceptable anion; and y and z are independently an integer from 0 to about 30.

Compounds of the formula (40), (41), (42) or (43) were prepared by addition of a compound $\text{R}^1\text{-X}-(\text{R}^2\text{O})_n\text{-XH}$ to an epoxide in a 1:1 molar ratio in the presence of a base such as diisobutyl aluminum hydride (DIBAL) as represented below:

64725-903 (D)

140

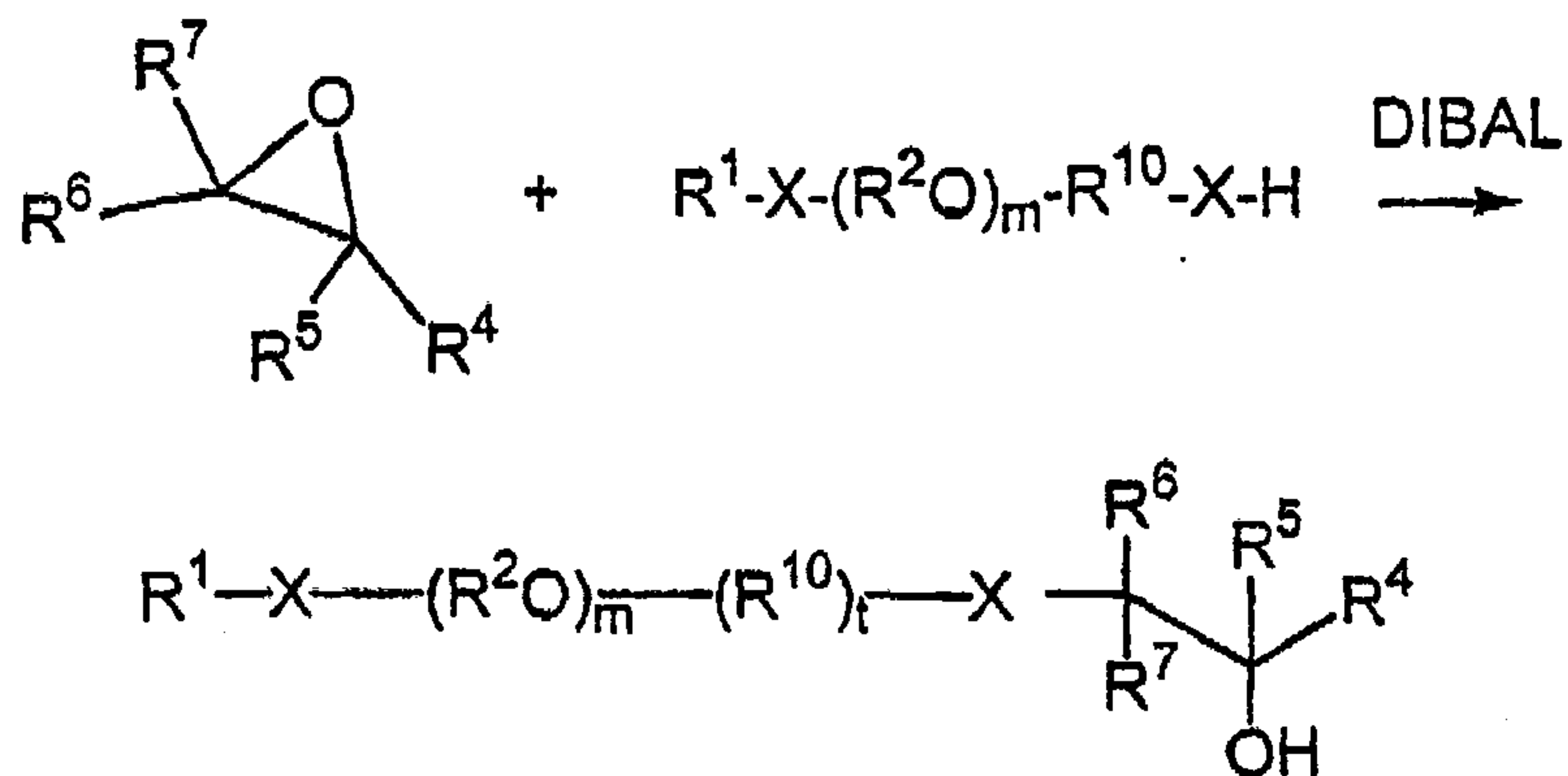

(93)

The compound (93) is then alkoxyated via conventional means to form a compound of formula (40). When the starting material includes one quaternary ammonium salt (i.e., one X is $-\text{N}^+\text{R}^8\text{R}^9-$), the compound has the formula (41) or (42). When two quaternary ammonium salts are present in the starting material (i.e., one X is $-\text{N}^+\text{R}^8\text{R}^9-$ and the other is $-\text{N}^+\text{R}^{11}\text{R}^{12}-$), a compound of formula (43) is formed.

Example F: Preparation of Gemini Glucitols ZZ, AAA, BBB, CCC of formula (28)

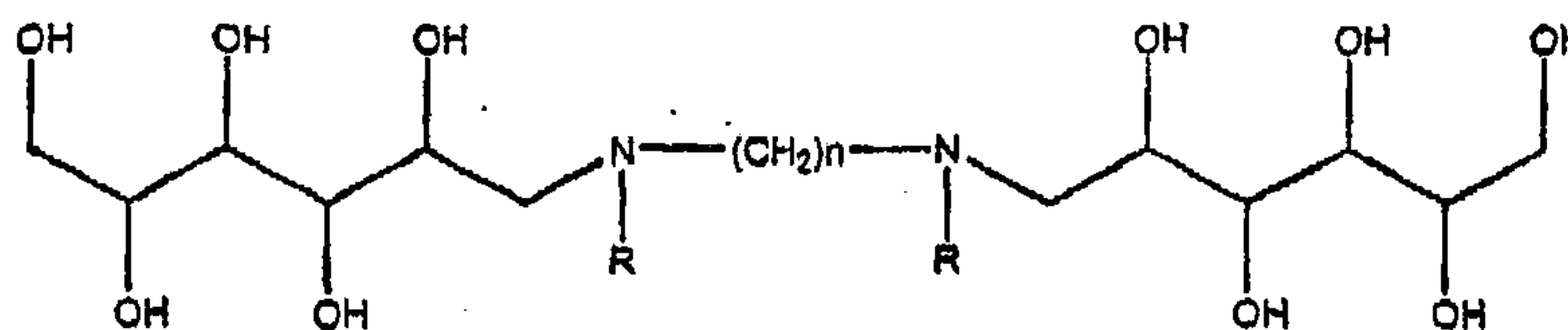

(94)

Compound ZZ:

1,12 methylaminoglucitoldodecane: R= methyl, n=12: 1-deoxy-1-(methylamino)-D-glucitol (195 MW, 15g, 2 eq.), 1,12 dibromododecane (328

64725-903 (D)

141

MW, 12.6g, 1 eq.), sodium bicarbonate (7.1g, 2.2 eq) and 120ml anhydrous dimethylformamide, were placed under nitrogen and heated for 17 hours at 70°C. After the reaction was complete, any unreacted sodium bicarbonate was removed by filtration and then DMF was removed from the reaction under reduced pressure. 400 ml of ethyl acetate was added to precipitate the crude product and the mixture was stirred for several hours to remove occluded DMF from the precipitated product. The crude product was recrystallized twice from a 1:1 solution of methanol/water to give 6.68g white solid or 15% yield. H NMR 300 MHz, MeOD⁴: 1.25-1.4(broad, 16H), 1.5p (quint, 4H), 2.45p(sept., 4H), 2.55p(d, 4H), 3.6-3.8p(complex, 12H). Analysis: C₂₆H₅₈N₂O₁₁: Theory: C, 54.3, H, 10.1, N, 4.8. Found: C, 54.2, H, 9.9, N, 4.5.

Compound AAA

1,6 hexylaminoglucitol propane: R= hexyl, n=3: 1-deoxy-1-(hexylamino)-D-glucitol (265 MW, 15.76g, 2 eq.), 1,3-dibromopropane (202 MW, 6.0g, 2 eq.), sodium bicarbonate (5.49g, 2.2 eq.) and 180ml anhydrous dimethylformamide, were placed under nitrogen and heated for 17 hours at 70°C. After the reaction was complete, any unreacted sodium bicarbonate was removed by filtration and then DMF was removed from the reaction under reduced pressure. 600ml of ethyl acetate was added to precipitate the crude product and the mixture was stirred for several hours to remove occluded DMF from the precipitated product. The solvents were decanted and the product underwent additional drying in a vacuum oven overnight at 80°C. 12g of yellow semi-solid that was 90% pure. All attempts at recrystallization or chromatography for additional purification were unsuccessful. Yield, 71%. H NMR 500 MHz, MeOD⁴. 0.9p(t, 6H), 1.25-1.4p (broad, 12H), 1.55p(quint, 4H), 1.75p(quint, 2H), 2.55-2.75p(complex, 12H), 3.6-3.8p(complex, 12H). C NMR 50 MHz, MeOD⁴: 13.8p, 22.8p, 25.8p, 26.5p, 26.2p, 32.0p, 53.0p, 54.5p, 56.8p, 63.8p, 70.0p, 71.2p, 72.0p, 72.5p. 2D-NMR experiments provided conclusive structure confirmation.

64725-903 (D)

142

Compound CCC

1,8 hexylaminoglucitol octane: R=hexyl, n=8: 1-deoxy-1-(hexylamino)-D-glucitol (265 MW, 15.0g, 2 eq.), 1,8-dibromooctane (262 MW, 7.68g, 1 eq.),^c potassium carbonate (8.56g, 2.2 eq.) and 180ml anhydrous dimethylformamide, were placed under nitrogen and heated for 20 hours at 70°C. After the reaction was complete, any unreacted potassium carbonate was removed by filtration and then DMF was removed from the reaction under reduced pressure. 600 ml of ethyl acetate was added to precipitate the crude product and the mixture was stirred for several hours to remove occluded DMF from the precipitated product. The solvents were decanted and the product underwent additional drying in a vacuum oven overnight at 80°C. Further purification was achieved by dissolving the crude product in a minimum of methanol and discarding any precipitated solids. 13.6g yellow semi-solid was recovered that was 90% pure. Yield, 38%. H NMR 300 MHz, MeOD^d: 0.9p(t, 6H), 1.2-1.4p(broad, 18H), 1.4-1.6p(broad, 8H), 2.4-2.6p(complex, 12H), 3.55-3.8(complex, 12H).

Compound BBB

1,8 octylaminoglucitol propane: R= octyl, n=3: 1-deoxy-1-(octylamino)-D-glucitol (293 MW, 6.45g, 2 eq.), 1,3-dibromopropane (202 MW, 2.2g, 1 eq.), sodium bicarbonate (2.0g, 2.2 eq.) and 60ml anhydrous dimethylformamide, were placed under nitrogen and heated for 17 hours at 70°C. After the reaction was complete, any unreacted sodium bicarbonate was removed by filtration and then DMF was removed from the reaction under reduced pressure. 200ml of ethyl acetate was added to precipitate the crude product and the mixture was stirred for several hours to remove occluded DMF from the precipitated product. The solvents were decanted and the product underwent additional drying in a vacuum oven overnight at 80°C. 8.88g white semi-solid that was 90% pure was recovered. All attempts at recrystallization or chromatography for additional purification were unsuccessful. Yield, 64%. H NMR 600 MHz, MeOD^d: 0.87p(t, 6H), 1.2-1.35p(broad, 20H), 1.5p(quint., 4H), 1.7p(quint., 2H), 2.5-2.7p(complex, 12H), 3.6-3.8p(complex, 12H). C NMR 600 MHz, MeOD^d: 14.6p, 23.7p,

64725-903 (D)

143

24.55p, 27.4p, 28.6p, 30.4p, 30.8p, 33.0p, 54.0p, 55.8p, 58.2p, 64.8p, 71.7p, 72.5p, 73.0p, 73.8p. 2D NMR experiments provided conclusive structure confirmation.

Example G: Preparation of compound of formula (23)

An alkoxyated amine is prepared, wherein the amine has the formula:

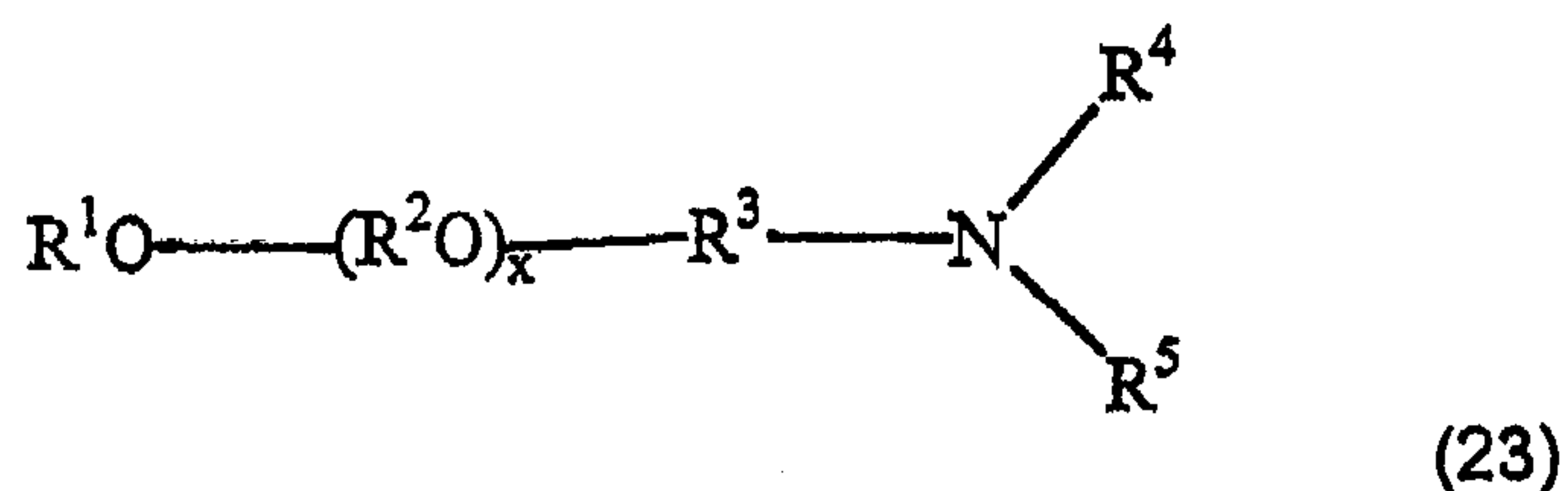

A commercially available alcohol ethoxylate of choice (such as Brij™ 58) was converted to the corresponding tosylate by treatment with tosyl chloride in the presence of potassium hydroxide. The resulting tosylate was then reacted with an appropriate alkylamine (such as methylamine, benzylamine, dimethylamine, etc.) in anhydrous tetrahydrofuran (THF) at 80 °C overnight to afford the desired product.

Example H: Preparation of compound of formula (25)

An alkoxyated poly(hydroxyalkyl)amine having the formula below is prepared as follows:

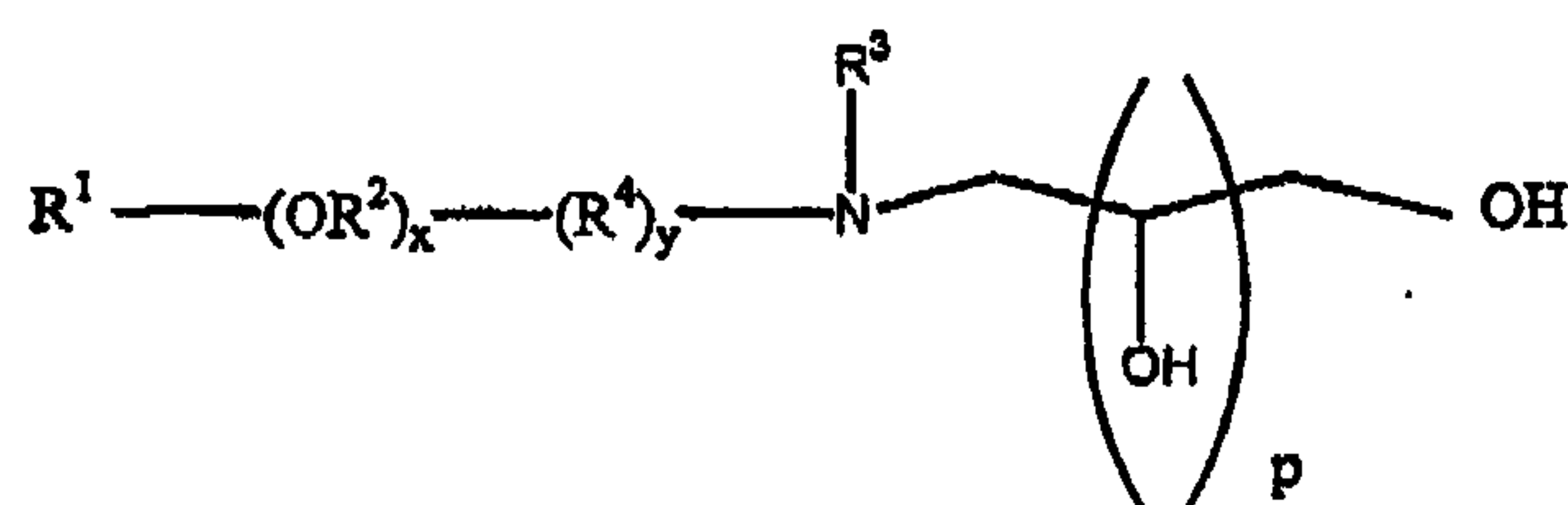

(25)

A commercially available alcohol ethoxylate of choice (such as Brij™ 58) was converted to the corresponding tosylate by treatment with tosyl chloride in the

64725-903 (D)

144

presence of potassium hydroxide. The resulting tosylate was then reacted with an appropriate amine derivative (such as n-alkyl glucamines, etc.) in the presence of anhydrous powdered sodium bicarbonate in refluxing anhydrous ethanol for one to two days to afford the desired product.

Example I: Preparation of compound of formula (74)

An alkoxyated quaternary ammonium salt having the formula below is prepared as follows:

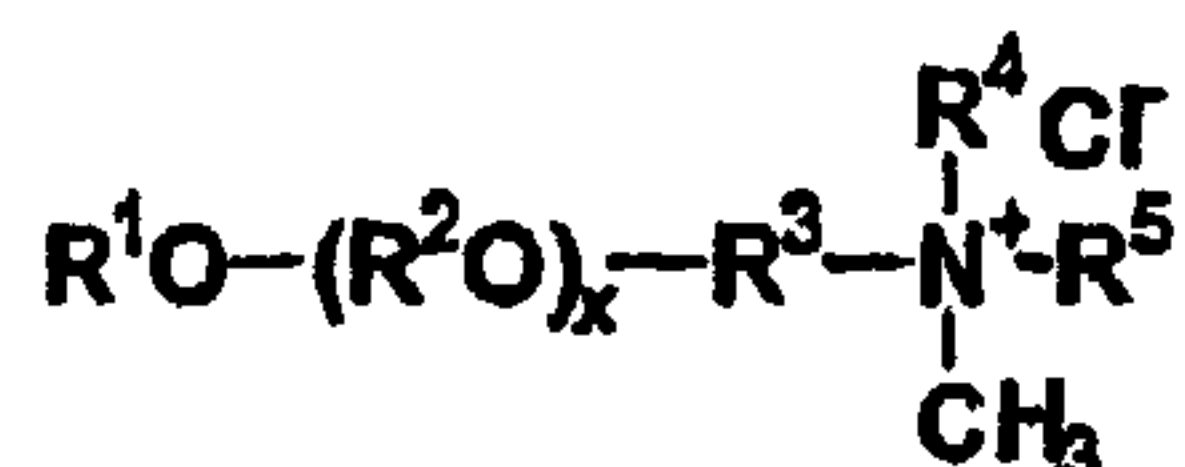

An alkoxyated amine of formula (73) was treated with methyl chloride in anhydrous THF at 50 °C overnight to afford the desired product.

Example J: Preparation of compound of formula (32)

An amine oxide was prepared as follows:

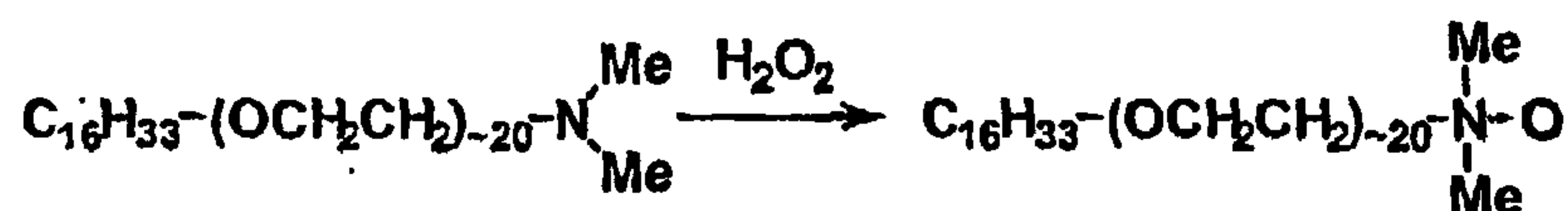

Alkyl alkoxy dimethylamine was oxidized by hydrogen peroxide in methanol at room temperature overnight to afford the desired product.

Example K: Preparation of compounds of formula (72):

A guanidine compound of the formula (72) was prepared as follows.

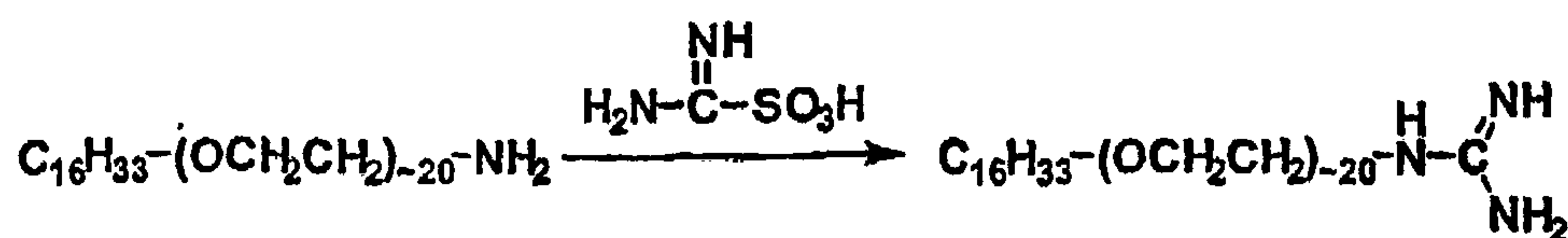

64725-903 (D)

145

Alkyl alkoxy amine was converted to the desired product by treatment with formamidesulfonic acid in methanol at room temperature overnight.

Another compound of formula (72) was prepared as shown below.

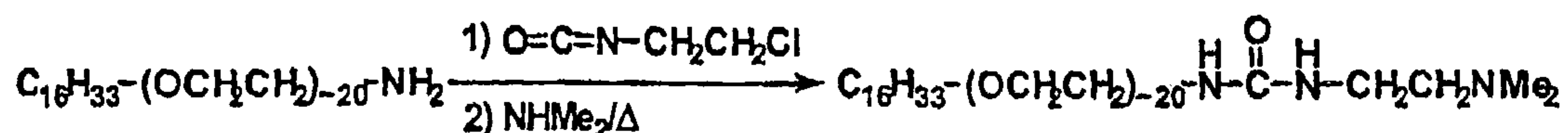

The product was synthesized by acylation of the corresponding amine with chloroethyl isocyanate, followed by replacement of chloride with dimethylamine.

Example L: Preparation of compounds of formula (78) and (79)

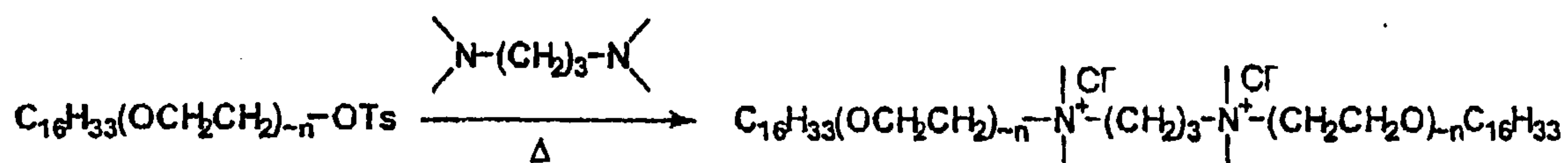

The compound (79) was made by alkylation of tetramethylpropylene diamine with excess of hexadecyl poly(ethylene oxide) tosylate in refluxing ethanol for two days, and purified by DOWEX 50WX2-400 ion exchange resin eluting with 50% concentrated HCl in ethanol.

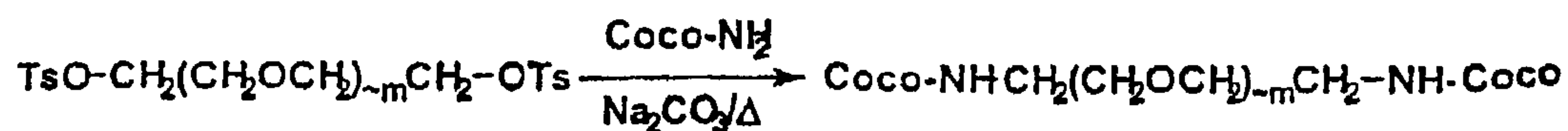

The compound (78) was prepared by alkylation of cocoamine with poly(ethylene oxide) ditosylate in the presence of anhydrous powder sodium carbonate in refluxing ethanol for two days.

64725-903 (D)

146

The compound was prepared by reaction of the corresponding diamines with two equivalents of an acid chloride followed by reduction of the resulting diamide with lithium aluminum hydride (LAH). Alternatively, this compound can be prepared by reaction of the diamine with two equivalents of a long alkyl chain bromide. The Gemini diamines were ethoxylated under standard conditions.

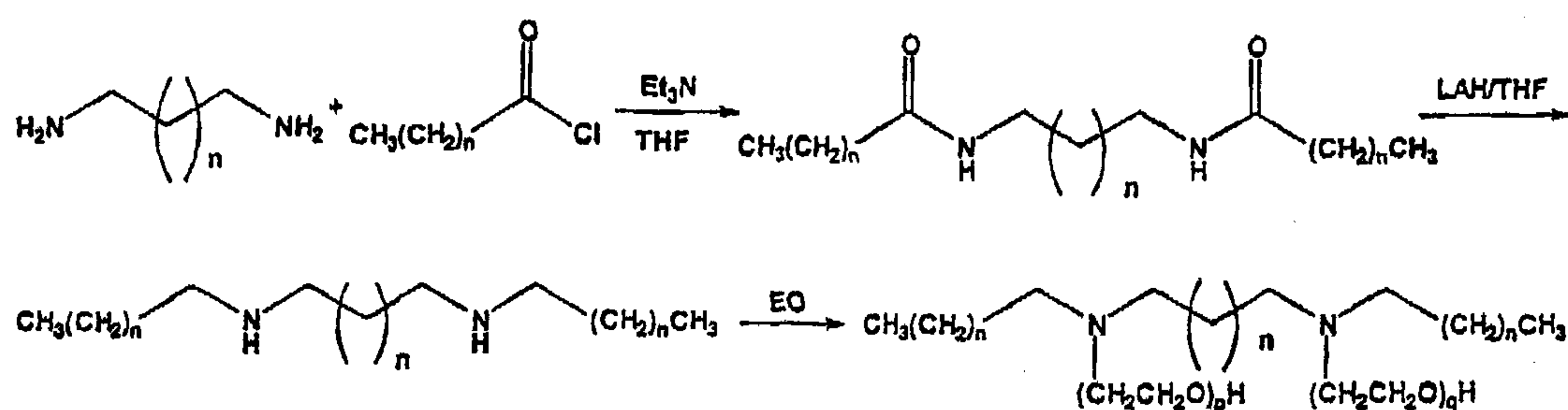

Example N: Preparation of compound of formula (26):

A commercially available alcohol ethoxylate is converted to the corresponding tosylate by treatment with tosyl chloride in the presence of potassium hydroxide. D-glucosamine hydrochloride is then reduced in the presence of sodium borohydride and water to give the ring opened glucosamine salt. In the presence of potassium carbonate, the glucosamine is reacted with alkylethoxytosylate to give the desired product as shown below:

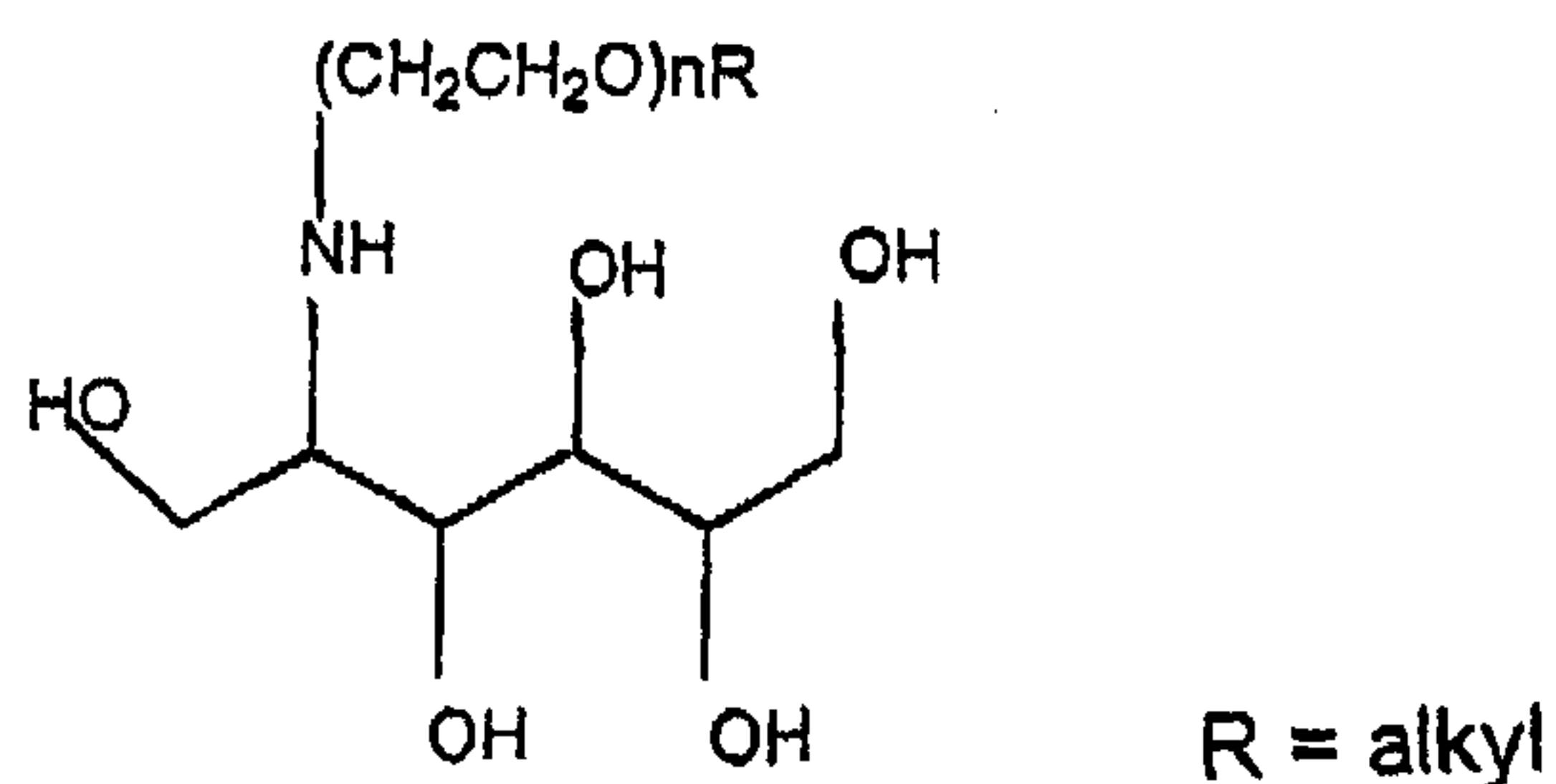

64725-903 (D)

147

5 D-glucosamine hydrochloride is reduced in the presence of sodium borohydride and water to give the ring opened glucosamine salt. The glucosamine salt is neutralized with sodium hydroxide and reacted with an alkylaldehyde of suitable chain length under reducing conditions, i.e., in the presence of ethanol, 4% Pd/C and hydrogen gas at 60 psig and 40 °C to give the desired product as shown below:

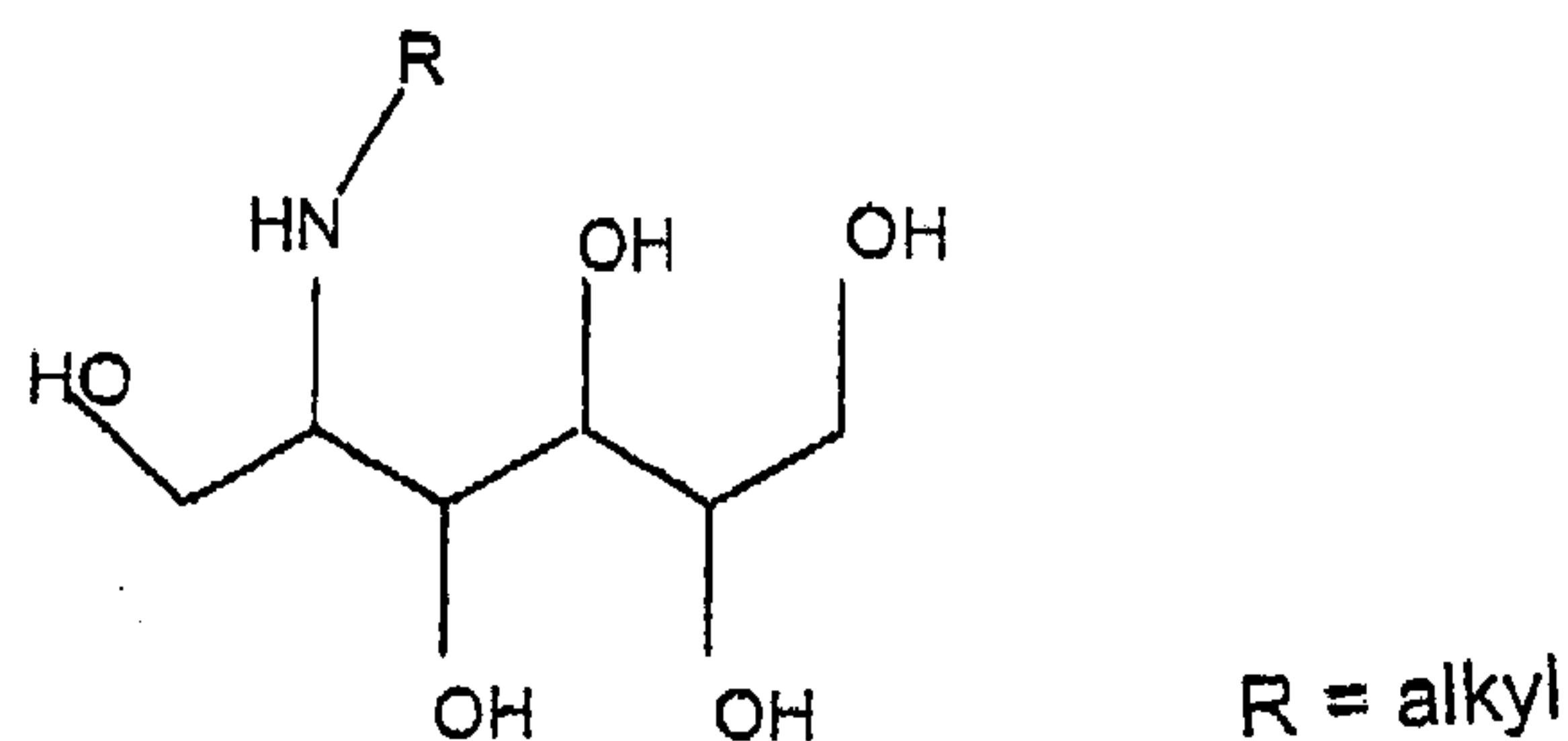

) Alkoxylated compounds of formulae (33), (35), (64) and (71) are prepared by selecting a commercially available starting material, such as a tertiary amine, and alkoxylating the starting material by methods known in the art to form one of the alkoxylated compounds.

Example P. Testing for the formation of anisotropic aggregates and/or liquid crystals

Utilizing the various methods disclosed herein for determining whether a surfactant, in the presence of glyphosate, forms an anisotropic aggregate, an epicuticular liquid crystal, and/or an intracuticular liquid crystal, numerous surfactants have been tested by the inventors for the formation of anisotropic aggregates and/or liquid crystals. A number of surfactants in the presence of glyphosate have been tested utilizing a isopropylamine glyphosate formulations while other surfactants have been tested in potassium glyphosate formulations. The table set forth below illustrates the results of the numerous tests.

64725-903 (D)

148

c

Nonionic Surfactant having the Formula: $C_wO-(EO)_xH$					
in IPA Glyphosate Formulation:					
w	x	Trade Name	LC intr a	LC epi	AA
11	9	Neodol 1-9	N	N	N
12	10	Procol LA-10	N	N	N
12	12	Procol LA-12	N	N	N
12	15	Procol LA-15	N	N	Y
12 (laureth)	23	Brij 35	N	Y	Y
11-15	9	Tergitol 15-S-9	N	N	N
11-15	12	Tergitol 15-S-12	N	N	NT
11-15	15	Tergitol 15-S-15	N	N	NT
12-15	12	Neodol 15-12	N	N	Y
16	2	Hetoxol CA-2	N	N	N
16	7	ST-8302	N	N	N
16	10	Hetoxol CA-10	N	N	Y
16	14	ST-8303	N	N	Y
16	20	Hetoxol CA-20	Y	Y	Y
16-18	9	Hetoxol CS-9	N	N	Y
16-18	15	Hetoxol CS-15	N	N	Y
16-18	20	Hetoxol CS-20	NT	Y	Y
16-18	25	Hetoxol CS-25	Y	Y	Y
16-18	27	Plurafac A38	Y	Y	Y
16-18	30	Hetoxol CS-30	NT	Y	Y
18	10	Brij 76	N	Y	Y
18	20	Brij 78	Y	Y	Y
iso18	10	Arosurf 66 E10	N	N	N

64725-903 (D)

149

iso18	20	Arosurf 66 E20	N	Y	Y
18 (oleath)	10	Brij 97	N	Y	Y
18 (oleath)	20	Brij 98	NT	Y	Y
Other Nonionic Surfactants in IPA Glyphosate Formulation:			LC intr a	LC epi	AA
Agrimul PG2069 alkyl polyglucoside			N	N	N
Surfonic DNP 80 (PEG 8 dinonyl phenol)			N	N	N
Surfonic DNP 100 (PEG 10 dinonyl phenol)			NT	NT	Y
Surfonic DNP 140 (PEG 15 dinonyl phenol)			NT	NT	Y
Surfonic DNP 240 (PEG 24 dinonyl phenol)			NT	NT	Y
Cationic Surfactant having the Formula:					
$C_w - N \begin{cases} (EO)_x H \\ (EO)_y H \end{cases}$					
in IPA Glyphosate Formulation:					
w	x+y	Trade Name	LC Intr a	LC epi	AA
coco (8-16)	2	Ethomeen C/12	N	N	N
coco	5	Ethomeen C/15	N	N	N
coco	10	Ethomeen C/20	N	N	N
coco	15	Ethomeen C/25	N	N	N
tallow (16-18)	2	Ethomeen T/12	N	N	N
tallow	2	Armeen T12	N	N	N
tallow	5	Ethomeen T/15	N	N	N
tallow	10	Ethomeen T/20	N	N	N

64725-903 (D)

tallow	15	Ethomeen T/25	N	N	N
stearyl (18)	50	Trymeen 6617	N	Y	Y
In Potassium Glyphosate Formulation:					
coco (8-16)	2	Ethomeen C/12	NT	N	Y
coco	5	Ethomeen C/15	N	N	N
tallow (16-18)	2	Armeen T12	N	N	Y
tallow	5	Ethomeen T/15	NT	Y	Y
Cationic Surfactant having the Formula:					
$C_w - N \begin{matrix} / H \\ \backslash H \end{matrix}$					
in IPA Glyphosate Formulation:					
w	Trade Name:		LC intr a	LC epi	AA
tallow (16-18)	Armeen T		N	N	N
Cationic Surfactant having the Formula:					
$C_w - N \begin{matrix} / CH_3 \\ \backslash CH_3 \end{matrix}$					
in IPA Glyphosate Formulation:					
w	Trade Name:		LC intr a	LC epi	AA
10	NA		N	N	N
coco (8-16)	Armeen DMCD		N	N	N
tallow (16-18)	Armeen TMCD		N	N	N
tallow	Armeen DMTD		N	N	N

64725-903 (D)

151

in Potassium Glyphosate Formulation:					
w	Trade Name:		LC	LC	AA
			intr	epi	
			a		
coco (8-16)	Armeen DMCD		N	N	N
tallow (16-18)	Armeen DMTD		N	Y	Y
Cationic Surfactant					
having the Formula:					
$\text{C}_w - \text{N} \begin{array}{l} \diagup \text{C}_w \\ \diagdown \text{H} \end{array}$					
in IPA Glyphosate Formulation:					
w	Trade Name:		LC	LC	AA
			intr	epi	
			a		
coco (8-16)	Armeen 2C		N	N	NT
tallow (16-18)	Armeen 2T		N	N	Y
Cationic Surfactant					
having the Formula:					
$\text{C}_w - \text{N} \begin{array}{l} \diagup (\text{EO})_x\text{H} \\ \diagdown \text{CH}_3 \end{array}$					
in IPA Glyphosate Formulation:					
w	x+y	Trade Name	LC	LC	AA
			intr	epi	
			a		
stearyl (18)	7	NA	N	N	N
	22	Arosurf 66 E20	N	Y	Y

64725-903 (D)

152

Cationic Surfactant having the Formula:

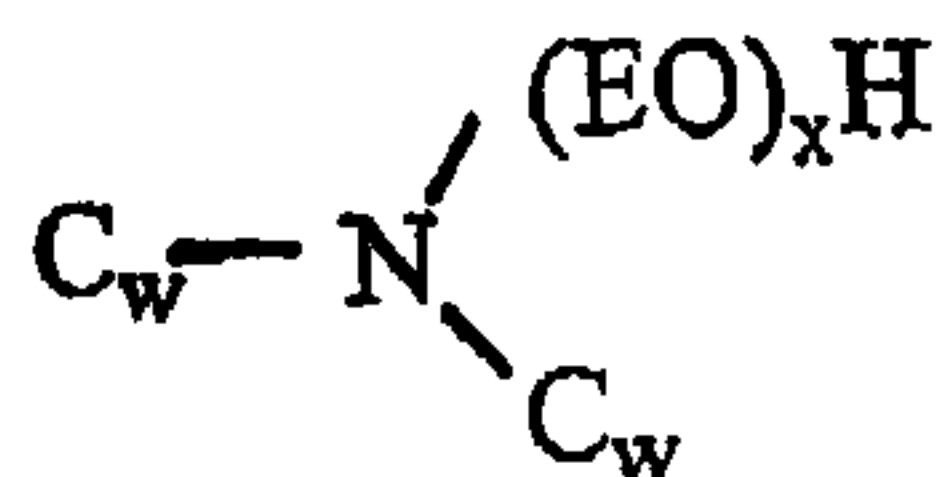

in IPA Glyphosate Formulation:

w	x	Trade Name	LC Intr a	LC epi	AA
coco (8-16)	5	NA	N	N	N
coco	10	NA	N	N	N
coco	15	NA	N	N	Y
coco	20	NA	N	N	Y
tallow (16-18)	5	NA	NT	Y	Y
tallow	10	NA	NT	Y	Y
tallow	15	NA	NT	Y	Y
tallow	20	NA	NT	Y	Y

Cationic Surfactant having the Formula:

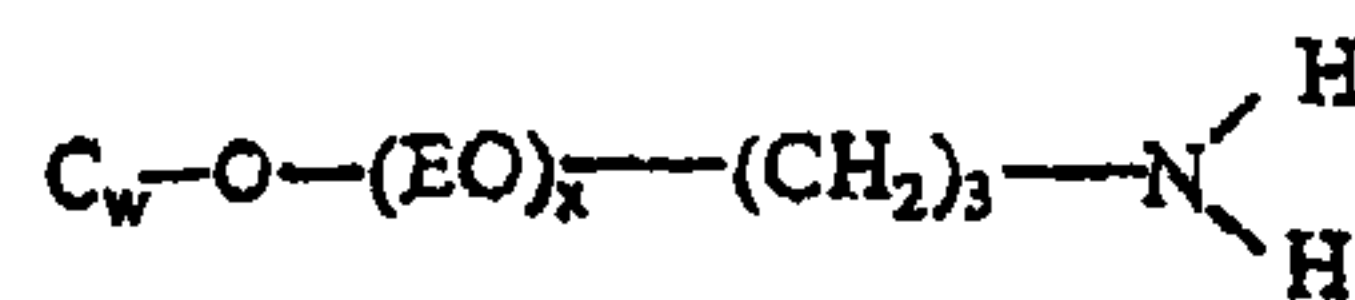

in IPA Glyphosate Formulation:

w	x	Trade Name	LC intr a	LC epi	AA
14-15	7	NA	N	N	NT
14-15	13	NA	NT	Y	Y
14-15	18	NA	NT	Y	Y

64725-903 (D)

153

16-18	7	NA	N	N	NT
16-18	10	NA	N	N	NT
16-18	15	NA	NT	Y	Y
16-18	20	NA	NT	Y	Y
in Potassium Glyphosate Formulation:					
w	x	Trade Name	LC intr a	LC epi	AA
isotridecyl oxy	5	Tomah E-17-5	N	N	N
14-15	7	NA	N	N	NT
14-15	13	NA	NT	Y	Y
14-15	18	NA	NT	Y	Y
16-18	7	NA	NT	Y	Y
16-18	10	NA	NT	Y	Y
16-18	15	NA	NT	Y	Y
Cationic Surfactant having the Formula:					
$C_w - O - (EO)_x - (CH_2)_3 - N \begin{matrix} \nearrow CH_3 \\ \searrow CH_3 \end{matrix}$					
in IPA Glyphosate Formulation:					
w	x	Trade Name	LC intr a	LC epi	AA
14-15	13	NA	NT	Y	Y

64725-903 (D)

in Potassium Glyphosate Formulation:					
w	x	Trade Name	LC intr a	LC epi	AA
14-15	13	NA	NT	Y	Y
14-15	18	NA	NT	Y	Y
16-18	15	NA	NT	Y	Y
Cationic Surfactant having the Formula: <div style="text-align: center; margin: 10px 0;"> $\begin{array}{c} (\text{EO})_x\text{H} \\ \\ \text{C}_w - \text{N}^+ - (\text{EO})_y\text{H} \\ \\ \text{CH}_3 \end{array}$ </div> <div style="text-align: right; margin-right: 50px;">X⁻</div>					
in IPA Glyphosate Formulation:					
w	x+y	Trade Name	LC intr a	LC epi	AA
coco (8-16)	2	Ethoquad C/12	N	N	NT
coco	5	NA	N	N	NT
coco	5	Rewoquat CPEM	N	N	NT
tallow (16-18)	2	Ethoquad T/12	N	N	N
tallow	5	NA	N	N	NT
tallow	10	Ethoquad T/20	N	N	NT
tallow	15	Ethoquad 5/25	N	N	NT
in Potassium Glyphosate Formulation:					
w	x+y	Trade Name	LC intr a	LC epi	AA
coco (8-16)	2	Ethoquad C12	NT	Y	Y
coco	5	NA	NT	Y	Y

64725-903 (D)

tallow (16-18)	5	Ethoquad T12	NT	Y	Y
Cationic Surfactant having the Formula: $ \begin{array}{c} (\text{EO})_x\text{H} \\ \\ \text{C}_w - \text{N}^+ - (\text{EO})_y\text{H} \\ \\ \text{C}_w \end{array} $					
in IPA Glyphosate Formulation:					
w	x+y	Trade Name	LC intr a	LC epi	AA
tallow (16-18)	5	NA	NT	Y	Y
tallow	10	NA	NT	Y	Y
tallow	30	NA	N	N	N
Cationic Surfactant having the Formula: $ \begin{array}{c} \text{CH}_3 \\ \\ \text{C}_w - \text{N}^+ - (\text{EO})_x\text{H} \\ \\ \text{CH}_3 \end{array} $					
in IPA Glyphosate Formulation:					
w	x	Trade Name	LC intr a	LC epi	AA
18	7	NA	NT	NT	Y
18	22	NA	NT	NT	Y

64725-903 (D)

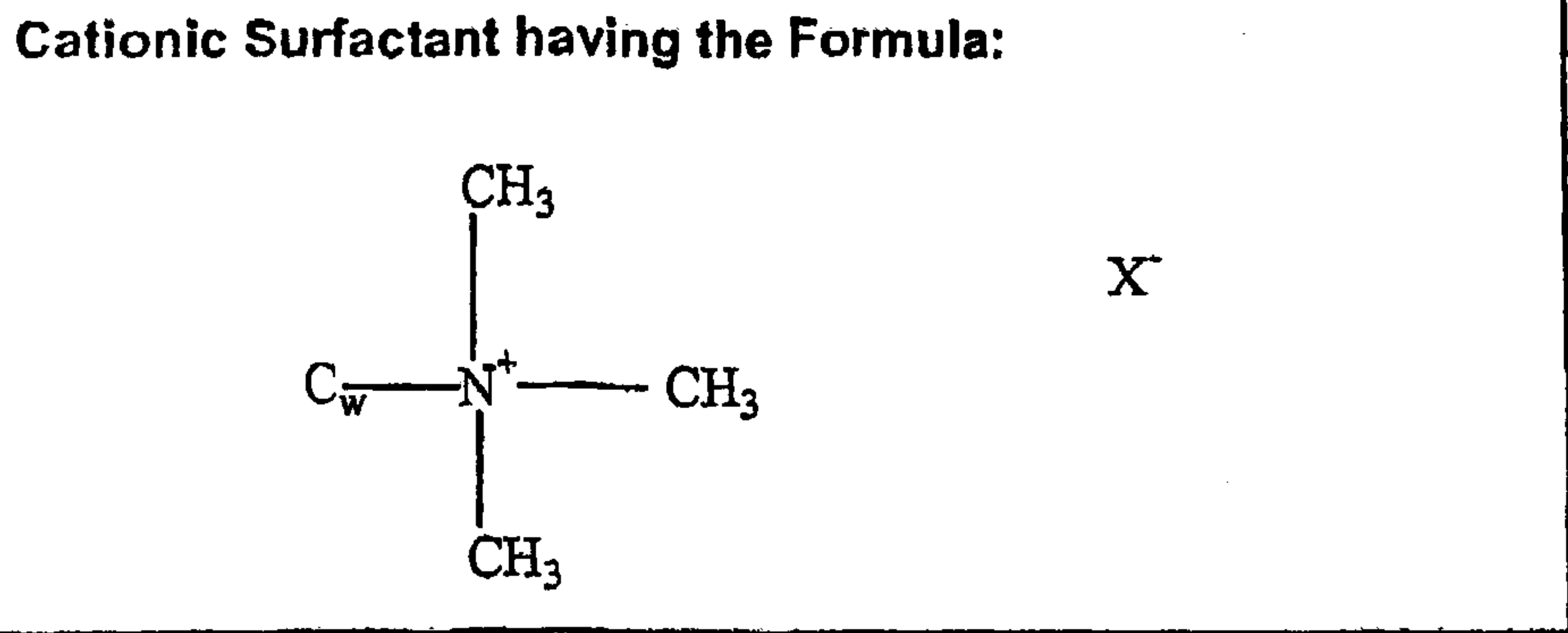

in IPA Glyphosate Formulation:

w	Trade Name	LC intr a	LC epi	AA
dodecyl (12)	Arquad C-50	N	N	N
tallow (16-18)	Arquad T-50	N	N	NT

in Potassium Glyphosate Formulation:

w	Trade Name	LC intr a	LC epi	AA
dodecyl (12)	Arquad C-50	NT	Y	Y
tallow (16-18)	Arquad T-50	NT	Y	Y

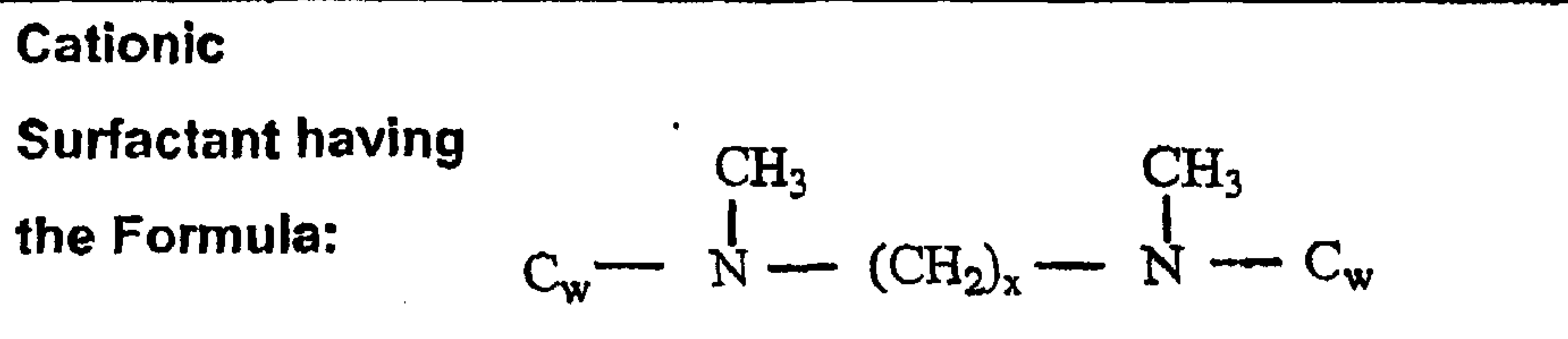

in IPA Glyphosate Formulation:

w	x	Trade Name	LC intr a	LC epi	AA
10	2	Gemini 10-2-10	NT	NT	Y
10	3	Gemini 10-3-10	NT	NT	Y
10	4	Gemini 10-4-10	NT	NT	Y
14	2	Gemini 14-2-14	NT	NT	Y
14	3	Gemini 14-3-14	NT	NT	Y

64725-903 (D)

157

16	2	Gemini 16-2-16	NT	NT	Y
Anionic Surfactant in IPA Glyphosate Formulation:					
Name			LC intr a	LC epi	AA
oleth-10 phosphate			N	N	Y
oleth-20 phosphate			N	N	Y
oleth-25 phosphate			N	N	Y
2-ethylhexyl phosphate			N	N	N
laureth-3 phosphate			N	N	N
palmitic acid			N	N	Y
oleic acid			N	N	Y
stearic acid			N	N	Y
caprylic acid			NT	NT	N
sodium alkylbenzene sulfonate			N	N	NT
sodium lauryl sulfate			N	N	Y
phosphated aryl ethoxylate			N	N	N
phosphate ester, free acid			N	N	N
phosphated nonyl phenyl ethoxylate, free acid			N	N	N
Amphoteric Surfactant in an IPA Glyphosate Formulation:					
Trade Name			LC intr a	LC epi	AA
Lecithin			N	Y	Y
Velvetex™ BC coco betaine			N	N	N

64725-903 (D)

158

Fluorinated Surfactant in an IPA Glyphosate Formulation:			
Trade Name	LC intr a	LC epi	AA
Fluorad™ 135 alkyl quaternary ammonium iodides	N	N	N
Fluorad™ 754 alkyl quaternary ammonium chlorides	N	N	N
Fluorad™ FC129 potassium fluorinated alkyl carboxylate	N	N	N
Fluorad™ FC-171 fluorinated alkyl alkoxyate	N	N	N
Fluroad™ FC121 ammonium perfluoroalkyl sulfonates	N	N	N
Fluowet PL 80 perfluorinated phosphinic/phosphonic acid	N	N	N
Surfactant Mixtures in IPA Glyphosate Formulation:	LC intr a	LC epi	AA
Hetoxol CA2/Ethomeen T/25	N	N	N
ST 8302/Ethoquad T/25	N	N	N
ST 8303/Ethoquad T/25	NT	Y	Y
Arosurf 66 E/10/Ethoquad T/25	NT	Y	Y
Arosurf 66 E20/Ethoquad T/25	NT	Y	Y
Arosurf 66 E20/Ethomeen T/25	NT	Y	Y
Hetoxol CS20/Ethomeen T/15	NT	Y	Y
Hetoxol CS20/Ethomeen T/20	Y	Y	Y
Hetoxol CS20/Ethomeen T/25	Y	Y	Y
Hetoxol CS20/Ethomeen T/30	NT	Y	Y
Hetoxol CS20/Ethomeen T/35	NT	Y	Y
Hetoxol CS20/Ethomeen T/40	NT	Y	Y

64725-903 (D)

159

Hetoxol CS20/Trymeen 6617	N	Y	Y
Hetoxol CS20+ Duoquat T-50	NT	NT	N
Hetoxol CS20+ Arquad C-50	NT	NT	Y
Hetoxol CS20 + lauryl choline chloride	NT	NT	Y
Hetoxol CS25 +Ethomeen T25	Y	Y	Y
Hetoxol CS15 +Ethomeen T25	NT	Y	Y
Hetoxol CS20 + Ethomeen T20	Y	Y	Y
Hetoxol CS25 + Ethomeen T20	Y	Y	Y
Hetoxol CS15 + lauryl choline chloride	NT	NT	Y
Brij 78 + Ethomeen T20	Y	Y	Y
Brij 78 + Ethomeen T25	Y	Y	Y
Brij 78 + Ethoquad T20	Y	Y	Y
Brij 78 + Ethoquad T25	Y	Y	Y
Neodol 1-9/Ethomeen T/25	N	N	N
Agrimul PG 2069/Ethomeen T/25	N	N	N
Tergitol 15-S-9/Ethomeen T/25	N	N	N
Tergitol 15-S-12/Ethomeen T/25	N	N	N
Tergitol 15-S-15/Ethomeen T/25	N	N	N
Procol LA 10 +Ethoquad T25	NT	NT	N
Procol LA 12 +Ethoquad T25	NT	NT	N
Procol La 15 + Ethoquad T25	NT	NT	Y
Hetoxol CS20 + PEG 7 dimethyl ammonium chloride	NT	NT	Y
Hetoxol CS20 + PEG 22 dimethyl ammonium chloride	NT	Y	Y
Plurafac A38 + Ethomeen T25	Y	Y	Y
Plurafac A38 + Ethoquad T25	Y	Y	Y
Plurafac A38 +Ethomeen T20	Y	Y	Y
Plurafac A38 + Ethoquad T20	Y	Y	Y
Hetoxol CS20 + Gemini 10-2-10	NT	NT	Y
Hetoxol CS20 + Gemini 10-3-10	NT	NT	Y
Hetoxol CS 20 +Gemini 10-4-10	NT	NT	Y

64725-903 (D)

160

Hetoxol CS 20 +Gemini 14-2-14	NT	NT	Y
Hetoxol CS 20 +Gemini 14-3-14	NT	NT	Y
Caprylic acid + Ethomeen T25	NT	NT	N
Capric acid + Ethomeen T25	NT	NT	N
Lauric acid + Ethomeen T25	NT	NT	N
Myristic acid + Ethomeen T25	NT	NT	N
Palmitic acid + Ethomeen T25	NT	NT	Y
Oleic acid + Ethomeen T25	NT	NT	N
Lecithin + Ethomeen T25	N	N	Y
Lecithin + Ethoquad T25	N	N	Y
Lecithin + Ethomeen T20	N	N	Y
Lecithin + Ethoquad T20	N	N	Y
Lecithin + Fluorad FC 754	N	N	Y
Lecithin + Hetoxol CS20	NT	Y	Y
Lecithin + Hetoxol CS25	NT	Y	Y
Fluowet PL 80 + Ethomeen T25	N	N	N
Ethoquad C12 + Tergitol 15-S-7	N	N	N
Ethoquad T12 + Tergitol 15-S-7	N	N	N
Ethoquad C12 + Tergitol 15-S-9	N	N	N
Ethoquad T12 + Tergitol 15-S-9	N	N	N
Ethoquad C12 + Tergitol 15-S-12	N	N	N
Ethoquad T12 + Tergitol 15-S-12	N	N	N
Ethoquad C12 + Tergitol 15-S-15	N	N	N
Ethoquad C12 + Arosurf 66 E10	NT	N	N
Ethoquad T12 + Arosurf 66 E10	NT	N	
Surfactant Mixtures in Potassium Glyphosate Formulation:	LC intr a	LC epi	AA
Ethoquad C12 + Tergitol 15-S-7	NT	Y	Y
Ethoquad T12 + Tergitol 15-S-7	NT	Y	Y
Ethoquad C12 + Tergitol 15-S-9	NT	Y	Y
Ethoquad T12 + Tergitol 15-S-9	NT	Y	Y

Ethoquad C12 + Tergitol 15-S-12	NT	Y	Y
Ethoquad T12 + Tergitol 15-S-12	NT	Y	Y
Ethoquad C12 + Tergitol 15-S-15	NT	Y	Y
Ethoquad T12 + Tergitol 15-S-15	NT	Y	Y
Ethoquad C12 + Arosurf 66 E10	NT	Y	Y
Ethoquad T12 + Arosurf 66 E10	NT	Y	Y

C_w is an alkyl group having w carbon atoms

X^- is a chloride anion

EO is ethylene oxide

AA is anisotropic aggregate

LC intra is intracuticular liquid crystal

LC epi is epicuticular liquid crystal

Y is yes

N is no

NT is not tested

NA is not applicable (i.e., no trade name)

An especially preferred herbicide is N-phosphonomethylglycine (glyphosate), a salt, adduct or ester thereof, or a compound which is converted to glyphosate in plant tissues or which otherwise provides glyphosate ion. Glyphosate salts that can be used according to this invention are outlined in U.S. Patent No. 4,405,531. The glyphosate salts are generally comprised of alkali metals, halogens, organic amines or ammonia, and include, but are not limited to, the following. The mono-, di- and tri- alkali metal salts of potassium, lithium and sodium. Salts of the alkali earth metals calcium, barium, and magnesium. Salts of other metals including copper, manganese, nickel and zinc. The mono-, di- and tri- halide salts of fluorine, chlorine, bromine, and iodine. Monoammonium, alkyl and phenyl ammonium salts, including the mono-, di- and tri- forms, comprising ammonium, methylammonium, ethylammonium, propylammonium,

64725-903 (D)

162

butylammonium and aniline. Alkylamine salts, including the mono-, di- and tri-forms, comprising methylamine, ethylamine, propylamine, butylamine, methylbutylamine, stearylamine and tallowamine. Alkenylamine salts based on ethylene, propylene or butylene. Cyclic organic amine salts including pyridine, piperidine, morpholine, pyrrolidone and picoline. Alkylsulfonium salts of methylsulfonium, ethylsulfonium, propyl sulfonium, and butyl sulfonium. Other salts including sulfoxonium, methoxymethylamine and phenoxyethylamine. Preferred salts of glyphosate include potassium (mono-, di- and tri- forms), sodium (mono-, di- and tri- forms), ammonium, trimethylammonium, isopropylamine, monoethanolamine and trimethylsulfonium.

Because the commercially most important herbicidal derivatives of N-phosphonomethylglycine are certain salts thereof, the glyphosate compositions useful in the present invention will be described in more detail with respect to such salts. These salts are well known and include ammonium, IPA, alkali metal (such as the mono-, di-, and tripotassium salts), and trimethylsulfonium salts. Salts of N-phosphonomethylglycine are commercially significant in part because they are water soluble. The salts listed immediately above are highly water soluble, thereby allowing for highly concentrated solutions that can be diluted at the site of use. In accordance with the method of this invention as it pertains to glyphosate herbicide, an aqueous solution containing a herbicidally effective amount of glyphosate and other components in accordance with the invention is applied to foliage of plants. Such an aqueous solution can be obtained by dilution of a concentrated glyphosate salt solution with water, or dissolution or dispersion in water of a dry (i.e., granular, powder, tablet or briquette) glyphosate formulation.

Exogenous chemicals should be applied to plants at a rate sufficient to give the desired biological effect. These application rates are usually expressed as amount of exogenous chemical per unit area treated, e.g. grams per hectare (g/ha). What constitutes a "desired effect" varies according to the standards and practice of those who investigate, develop, market and use a specific class of exogenous chemicals. For example, in the case of a herbicide, the amount

64725-903 (D)

163

applied per unit area to give 85% control of a plant species as measured by growth reduction or mortality is often used to define a commercially effective rate.

Herbicidal effectiveness is one of the biological effects that can be enhanced through this invention. "Herbicidal effectiveness," as used herein, refers to any observable measure of control of plant growth, which can include one or more of the actions of (1) killing, (2) inhibiting growth, reproduction or proliferation, and (3) removing, destroying, or otherwise diminishing the occurrence and activity of plants.

The herbicidal effectiveness data set forth herein report "inhibition" as a percentage following a standard procedure in the art which reflects a visual assessment of plant mortality and growth reduction by comparison with untreated plants, made by technicians specially trained to make and record such observations. In all cases, a single technician makes all assessments of percent inhibition within any one experiment or trial. Such measurements are relied upon and regularly reported by Monsanto Company in the course of its herbicide business.

The selection of application rates that are biologically effective for a specific exogenous chemical is within the skill of the ordinary agricultural scientist. Those of skill in the art will likewise recognize that individual plant conditions, weather and growing conditions, as well as the specific exogenous chemical and formulation thereof selected, will affect the efficacy achieved in practicing this invention. Useful application rates for exogenous chemicals employed can depend upon all of the above conditions. With respect to the use of the method of this invention for glyphosate herbicide, much information is known about appropriate application rates. Over two decades of glyphosate use and published studies relating to such use have provided abundant information from which a weed control practitioner can select glyphosate application rates that are herbicidally effective on particular species at particular growth stages in particular environmental conditions.

Herbicidal compositions of glyphosate or derivatives thereof are used to

64725-903 (D)

164

control a very wide variety of plants worldwide. Such compositions can be applied to a plant in a herbicidally effective amount, and can effectively control one or more plant species of one or more of the following genera without restriction: *Abutilon*, *Amaranthus*, *Artemisia*, *Asclepias*, *Avena*, *Axonopus*, *Borreria*, *Brachiaria*, *Brassica*, *Bromus*, *Chenopodium*, *Cirsium*, *Commelina*, *Convolvulus*, *Cynodon*, *Cyperus*, *Digitaria*, *Echinochloa*, *Eleusine*, *Elymus*, *Equisetum*, *Erodium*, *Helianthus*, *Imperata*, *Ipomoea*, *Kochia*, *Lolium*, *Malva*, *Oryza*, *Ottochloa*, *Panicum*, *Paspalum*, *Phalaris*, *Phragmites*, *Polygonum*, *Portulaca*, *Pteridium*, *Pueraria*, *Rubus*, *Salsola*, *Setaria*, *Sida*, *Sinapis*, *Sorghum*, *Triticum*, *Typha*, *Ulex*, *Xanthium*, and *Zea*.

Particularly important species for which glyphosate compositions are used are exemplified without limitation by the following:

Annual broadleaves:

velvetleaf (*Abutilon theophrasti*)

pigweed (*Amaranthus* spp.)

buttonweed (*Borreria* spp.)

oilseed rape, canola, indian mustard, etc. (*Brassica* spp.)

commelina (*Commelina* spp.)

filaree (*Erodium* spp.)

sunflower (*Helianthus* spp.)

morningglory (*Ipomoea* spp.)

kochia (*Kochia scoparia*)

mallow (*Malva* spp.)

wild buckwheat, smartweed, etc. (*Polygonum* spp.)

purslane (*Portulaca* spp.)

russian thistle (*Salsola* spp.)

sida (*Sida* spp.)

wild mustard (*Sinapis arvensis*)

cocklebur (*Xanthium* spp.)

Annual narrowleaves:

wild oat (*Avena fatua*)

64725-903 (D)

165

carpetgrass (*Axonopus* spp.)
downy brome (*Bromus tectorum*)
crabgrass (*Digitaria* spp.)
barnyardgrass (*Echinochloa crus-galli*)
goosegrass (*Eleusine indica*)
annual ryegrass (*Lolium multiflorum*)
rice (*Oryza sativa*)
ottochloa (*Ottochloa nodosa*)
bahiagrass (*Paspalum notatum*)
canarygrass (*Phalaris* spp.)
foxtail (*Setaria* spp.)
wheat (*Triticum aestivum*)
corn (*Zea mays*)
Perennial broadleaves:
mugwort (*Artemisia* spp.)
milkweed (*Asclepias* spp.)
canada thistle (*Cirsium arvense*)
field bindweed (*Convolvulus arvensis*)
kudzu (*Pueraria* spp.)
Perennial narrowleaves:
brachiaria (*Brachiaria* spp.)
bermudagrass (*Cynodon dactylon*)
yellow nutsedge (*Cyperus esculentus*)
purple nutsedge (*C. rotundus*)
quackgrass (*Elymus repens*)
lalang (*Imperata cylindrica*)
perennial ryegrass (*Lolium perenne*)
guineagrass (*Panicum maximum*)
dallisgrass (*Paspalum dilatatum*)
reed (*Phragmites* spp.)
johnsongrass (*Sorghum halepense*)

64725-903 (D)

cattail (*Typha* spp.) 166

Other perennials:

horsetail (*Equisetum* spp.)

bracken (*Pteridium aquilinum*)

blackberry (*Rubus* spp.)

gorse (*Ulex europaeus*)

Thus, the method of the present invention, as it pertains to glyphosate herbicide, can be useful on any of the above species.

Effectiveness in greenhouse tests, usually at exogenous chemical rates lower than those normally effective in the field, is a proven indicator of consistency of field performance at normal use rates. However, even the most promising composition

sometimes fails to exhibit enhanced performance in individual greenhouse tests. As illustrated in the Examples herein, a pattern of enhancement emerges over a series of greenhouse tests; when such a pattern is identified this is strong evidence of biological enhancement that will be useful in the field.

The compositions of the present invention can be applied to plants by spraying, using any conventional means for spraying liquids, such as spray nozzles, atomizers, or the like. Compositions of the present invention can be used in precision farming techniques, in which apparatus is employed to vary the amount of exogenous chemical applied to different parts of a field, depending on variables such as the particular plant species present, soil composition, and the like. In one embodiment of such techniques, a global positioning system operated with the spraying apparatus can be used to apply the desired amount of the composition to different parts of a field.

The composition at the time of application to plants is preferably dilute enough to be readily sprayed using standard agricultural spray equipment. Preferred application rates for the present invention vary depending upon a number of factors, including the type and concentration of active ingredient and the plant species involved. Useful rates for applying an aqueous composition to a field of foliage can range from about 25 to about 1,000 liters per hectare (l/ha)

by spray application. The preferred application rates for aqueous solutions are in the range from about 50 to about 300 l/ha.

Many exogenous chemicals (including glyphosate herbicide) must be taken up by living tissues of the plant and translocated within the plant in order to produce the desired biological (e.g., herbicidal) effect. Thus, it is important that a herbicidal composition not be applied in such a manner as to excessively injure and interrupt the normal functioning of the local tissue of the plant so quickly that translocation is reduced. However, some limited degree of local injury can be insignificant, or even beneficial, in its impact on the biological effectiveness of certain exogenous chemicals.

A large number of compositions of the invention are illustrated in the Examples that follow. Many concentrate compositions of glyphosate have provided sufficient herbicidal effectiveness in greenhouse tests to warrant field testing on a wide variety of weed species under a variety of application conditions.

The spray compositions of Examples 1-70 contained an exogenous chemical, such as glyphosate potassium salt, in addition to the excipient ingredients listed. The amount of exogenous chemical was selected to provide the desired rate in grams per hectare (g/ha) when applied in a spray volume of 93 l/ha. Several exogenous chemical rates were applied for each composition. Thus, except where otherwise indicated, when spray compositions were tested, the concentration of exogenous chemical varied in direct proportion to exogenous chemical rate, but the concentration of excipient ingredients was held constant across different exogenous chemical rates.

Concentrate compositions were tested by dilution, dissolution or dispersion in water to form spray compositions. In these spray compositions prepared from concentrates, the concentration of excipient ingredients varied with that of exogenous chemical.

In the following Examples illustrative of the invention, greenhouse and field tests were conducted to evaluate the relative herbicidal effectiveness of

glyphosate compositions. Compositions included for comparative purposes included the following:

Composition 139: which consists of 570 g/l of glyphosate IPA salt in aqueous solution with no added surfactant.

Composition 554: which consists of 725 g/l of glyphosate potassium salt in aqueous solution with no added surfactant.

Composition 754: which consists of 50% by weight of glyphosate IPA salt in aqueous solution, together with surfactant. This formulation is sold by Monsanto Company under the ROUNDUP ULTRAMAX® trademark.

Composition 360: which consists of 41% by weight of glyphosate IPA salt in aqueous solution, together with surfactant. This formulation is sold by Monsanto Company under the ROUNDUP ULTRA® trademark.

Composition 280: which consists of 480 g a.e./l of glyphosate IPA salt in aqueous solution, together with 120 g/l of ethoxylated etheramine surfactant (M121).

Composition 560: which consists of 540 g a.e./l of glyphosate potassium salt in solution, together with 135 g/l of ethoxylated etheramine surfactant (M121).

Composition 553: which consists of 360 g a.e./l of glyphosate IPA salt in solution, together with 111 g/l ethoxylated quaternary surfactant based tallowamine with 25EO, 74 g/l polyoxyethylene 10 EO cetyl ether and 12 g/l myristyl dimethyl amineoxide.

Composition 318: which consists of 487 g a.e./l of glyphosate potassium salt in aqueous solution, together with 65 g/l of ceteth(2PO)(9EO) alcohol alkoxyate, 97 g/l ethoxylated (10EO) tallowamine and 85 g/l n-octylamine.

Composition 765: which consists of 472 g a.e./l of glyphosate potassium salt in aqueous solution, together with 117 g/l cocoamine 5 EO, 52 g/l iso-stearyl 10 EO and 13 g/l cocoamine.

Various proprietary excipients were used in compositions of the Examples. They may be identified as follows:

64725-903 (D)

169

Ref.	Trade Name	Manufacturer	Chemical Description
1816E	1816E15PA		(C16-18)O(CH ₂ CH ₂ O) ₁₅ (CH ₂) ₃ NH ₂
AE10	Arosurf 66 E-10	Witco	Ethoxylated branched alkyl.10EO
AGN68	DF 68(89)	Agnique	Silicone defoamer
APG67	APG 2067		Alkyl polyglycoside C8-10 alkyl group and 1.7 glucose groups
APG69	APG 2069		Alkyl polyglycoside C8-10 alkyl group and 1.6 glucose groups
AR41	Arphos HE-6641	Witco	C ₄ EO ₃ phosphoric acid
ARMC	Armeen C		Mixed C8-16 (coco) alkyl primary amine
ARO66	Arosurf 66 E10	Witco	PEG-20 isostearyl ether
ARQ27	Arquad T-27W		27% solution of tallow trimethylammonium chloride
ARQ37	Arquad 1237W		Cocotrimethylammonium chloride (37% in water)
ARQ50	Arquad C-50	Akzo	Coco trimethyl ammonium chloride
B1A	B-2050-01A		Ethoxylated C16-18 linear alcohol 9.4 EO
B1B	B-2050-01B		Alkyloxylated C16-18 linear alcohol 9.4 EO + 2.2 PO
B1C	B-2050-01C		Alkyloxylated C16-18 linear alcohol 9.4 EO + 4.2 PO
B1F	B-2050-01F		Alkyloxylated C16-18 linear alcohol 9.6 EO + 4.4 PO
BRI35	Brij 35		Ethoxylated (23EO) lauryl ether

64725-903 (D)

170

BRI56	Brij 56		Polyoxyethylene (10EO) cetyl ether
BRI58	Brij 58		Polyoxyethylene (20EO) cetyl ether
BRI78	Brij 78		Ethoxylated (20EO) stearyl ether
CETAC			Cetyl trimethyl ammonium chloride
DUO50	Duoquat T-50	Akzo	Alkyl diamine quaternary salt
EA175		Tomah	EO etheramine
ED175		Tomah	EO Di-etheramine
EMC42	Emcol CC42	Witco	Polypropylene glycol-40 diethyl ammonium chloride
EMUL	Emulgin L	Cognis	Cetereth 2 propoxylate 9 ethoxylate
ETH12	Ethomeen C12	Akzo	Ethoxylated cocoamine 2EO
ETH15	Ethomeen T/15	Akzo	Ethoxylated tallow amine 5EO
ETH25	Ethomeen T/25	Akzo	15EO tallow ethoxylate quaternary ammonium chloride
EXP0A	EXP B 2030-A		coco 15 EO benyl quaternary
EXP0B	EXP B 2030-B		tallow 15 EO benyl quaternary
EXP0C	EXP B 2030-C		N, N-C16 dimethyl 14 EO benyl quaternary
EXP86	Experimental 5880-86B		Propoxylated C16-18 alcohol 10.4 PO
GEN2	Genamin T200NF AV 01/37-2	Clariant	Monoethoxylated alkylamine C18NMe(EO)7H
GEN3	Genamin T200NF AV 01/37-3	Clariant	Monoethoxylated alkylamine C18NMe(EO)15H

64725-903 (D)

171

GEN4	Genamin T200NF AV 01/37-4	Clariant	Monoethoxylated alkylamine C18NMe(EO)23H
HET20	Hetoxol CS20		Ethoxylated (20EO) C16-C18 ether
INT00	Intermediate PF 8000	Witco	Phosphate ester tridecanol + 4 EO (C13)O(CH2CH2)4(PO(OH2))
L770	Silwet L-77	Witco	hepamethyl trisiloxane 7EO methyl ether
LF700	Plurafac LF700	BASF	Alkoxylated C16-C18 alkyl
M117	MON 59117		Ethoxylated Ether Amine
M121	MON 58121	Huntsman Surfonic AGM550	(C12-14)O(CHCH3CH2)O- (CHCH3CH2)N (EO)x(EO)y x+y = 5
M128	MON78128		Formulation of 480 g a.e./l monoethanolamine glyphosate and 120 g/l M121
M368	MON 78368		Formulation of 357 g a.e./l IPA glyphosate with 57 g/l of EMUL, 85 g/l ethoxylated (10EO) tallowamine and 57 g/l n- octylamine.
M619	MON68619		Formulation of 360 g a.e./l IPA glyphosate with 70 g/l ETH25, 46 g/l BRI56 and 23 g/l CETAC
M620	MON68620		Formulation of 360 g a.e./l IPA glyphosate with 83 g/l ETH25, 56 g/l BRI56 and 27 g/l CETAC
MPE01	MPEAE		EO-etheramine

64725-903 (D)

172

c

MT13	M-T4513-2	Tomah	C14-15 dimethylated etheramine 13EO
NEO25	Neo 25-9		Ethoxylated alcohol with C12-15 hydrophobe and 9 EO
NO13	Nopar 13	Exxon	Normal paraffin
OA		Fluka	Octyl amine
PG069	APG-2069	Agrimul APG	C9-C11 alkyl ether glucoside
S01			Hexadecyl-eicosa(ethylene oxide) dimethyl amine
S02			Hexadecyl-deca(ethylene oxide)- 3-amino-propyl-1-amine
S03			Hexadecyl/octadecyl(propylene oxide)-nona(ethylene oxide)- dimethylamine
S04			Tallow-di(propylene oxide)- nona(ethylene oxide)-dibutylamine
S05			Tallow-di(propylene oxide)- nona(ethylene oxide)-3'-amino- propylamine.
S06			Tallow-di(propylene oxide)- nona(ethylene oxide)-N-methyl- glucamine
S07			Hexadecyl-penta(propylene oxide)-eicosa(ethylene oxide)- dimethylamine
S08			Tridecyl-hexa(ethylene oxide)- tri(propylene oxide)-dimethylamine
S09			N-methyloctadecylamino glucitol
S10			Hexadecyl-eicosa(ethylene oxide) dimethylamine

64725-903 (D)

173

S11			Hexadecyl-eicosa(ethylene oxide) Tris
S12			Hexadecyl-eicosa(ethylene oxide) methylamine
S13			Hexadecyl-deca(ethylene oxide)- N-methyl-glucamine
S14			1-deoxy-1-(octadecylamino)-D- glucitol
S15			Tallow-di(propylene oxide)- nona(ethylene oxide)-N-methyl- glucamine
S16			N-dodecylglucamine
S17			N-methyloctadecylamine glucitol
S18			N,N-dimethyloctadecyl glucitol chloro amino quat
S19			Ethoxylated cetyl alcohol
S20			N-methyldodecylamino glucitol
S21			N,N-dimethyldodecyl glucitol chloro amino quat
S22			10 EO isotridecyl phosphate ester (60% monoester)
S23			n-hexyl glucamine
S24			n-dodecyl glucamine
S39			Eicosane-1,20-bis(trimethyl ammonium chloride)
S40			Dodecane-1,12-bis(trimethyl ammonium chloride)
S41			Hexadecane-1,16- bis(trimethylammonium chloride)
S42			N,N-octylglucitol 1,3-propane
S43			N,N-dodecylglucitol 1,3-propane

64725-903 (D)

174

S44			N,N-hexylglucitol 1,3-propane
S45			N,N'-dioctyl-1,3-diaminopropane octa(ethylene oxide)
S46			N,N'-didodecyl-1,3- diaminopropane eicosa(ethylene oxide)
S47			N,N'-didecyl-1,3-diaminopropane deca (ethylene oxide)
S48			N,N'-didecyl-1,3-diaminopropane octadeca (ethylene oxide)
S49			N,N'-didodecyl-1,3- diaminopropane deca (ethylene oxide)
S50			N,N'-didodecyl-1,3- diaminopropane eicosa (ethylene oxide)
S51			Dodecyl-tetra(ethylene oxide) Tris
S52			Tris(hydroxymethyl),N- dodecylaminomethane
S53			Dodecyl-tetra(ethylene oxide) dimethyl amine
S54			Hexadecyl-deca(ethylene oxide) dimethylamine
S55			Dodecyl-tetra(ethylene oxide) trimethyl ammonium chloride
S56			Hexadecyl-deca(ethylene oxide) trimethyl ammonium chloride
S57			Hexadecyl-eicosa(ethylene oxide) trimethyl ammonium chloride
S58			Monoethoxylated alkylamine C18NMe(EO)7.5H

64725-903 (D)

175

S59			Monoethoxylated alkylamine C18NMe(EO)11H
S60			N-methyldodecylamino glucitol
S61			Ethoxylated cetyl alcohol (10EO)
S62			Hexadecyl-deca(ethylene oxide)- tris
S65			Octylamino glucitol
S66			Dodecyl-tetra(ethylene oxide) methylamine
S67			Hexadecyl-deca(ethylene oxide) methylamine
S68			Hexadecyl-eicosa(ethylene oxide) methylamine
S71			Bis-[N-hexadecyl-deca(ethylene oxide)-propylene-diammonium chloride
S72			Bis-[N-hexadecyl-eicosa(ethylene oxide)-propylene-diammonium chloride
S73			3-(N-dodecyl-methylamino)-1,2- propanediol-penta(ethylene oxide)
S74			3-(N-dodecyl-methylamino)-1,2- propanediol-deca(ethylene oxide)
S75			3-(N-methyl-octadecylamino)-1,2- propanediol-penta(ethylene oxide)
S76			3-(N-methyl-octadecylamino)-1,2- propanediol-deca(ethylene oxide)
S77			Hexadecyl/octadecyl-di(propylene oxide)-nona(ethylene oxide)- dimethylamine

64725-903 (D)

176

S78			1-hydroxy-3-(N-methyl-octadecylamino)-propan-2-ol-penta(ethylene oxide)
S79			1-hydroxy-3-(N-methyl-octadecylamino)-propan-2-ol-nona(ethylene oxide)
S80			1-hydroxy-3-(N-methyl-dodecylamino)-propan-2-ol-penta(ethylene oxide)
S81			Hexadecyl-deca(ethylene oxide)-hydroxyethylene-amine
S82			Hexadecyl-deca(ethylene oxide)-2'-methylamino-ethylene-N-methyl-amine
S83			Hexadecyl-deca(ethylene oxide)-2'-dimethylamino-ethylene-N-methylamine
S84			Hexadecyl-deca(ethylene oxide)-3'-amine-2'hydroxypropylamine
S85			Ethoxylated methyl stearyl amine 7.5EO
S86			Ethoxylated methyl stearyl amine 5.9EO
S87			Ethoxylated methyl stearyl amine 11EO
S88			$(C_4H_9)_2N(CH_2)_3NH_2$
S89			$(C_4H_9)_2N(CH_2)_3NMe_2$
S90			$(C_4H_9)_2N^+(I^-)(CH_2)_3N^+Me_3(I^-)$
S91			Eicosa(ethylene oxide)hexadecyl-N,N-dimethylamine

64725-903 (D)

177

S92			Tallow-eicosa(ethylene oxide)-dimethylamine
S93			Tallow-pentacosa(ethylene oxide)-dimethylamine
S94			Tallow-eicosa(ethylene oxide)-Tris
S95			Tallow-pentacosa(ethylene oxide)-Tris
S96			deca(ethylene oxide)hexadecyl-N,N-dimethylamine
S97			deca(ethylene oxide)eicosyl-N,N-dimethylamine
S98			hexadecyl-eicosa(ethylene oxide)-N-methyl-dodecylamine
S99			Bis-(Coca-amino)-eicosa(ethylene oxide)
S100			3-tallowamino-1,2-propanediol-pentadeca(ethylene oxide)
S101			3-tallowamino-1, 2-propanediol-trieicosa(ethylene oxide)
S102			3-tallowamino-1, 2-propanediol-heptaeicosa(ethylene oxide)
S103			3-cocoamino-1, 2-propanediol-trieicosa(ethylene oxide)
S104			3-cocoamino-1,2-propanediol-triaconta(ethylene oxide)
SC85	SC1485	Albermarle	Myristyl dimethyl amine oxide8
SUR10	Surfonic L12-10	Huntsman	C10-12 alcohol ethoxylate 10 EO
SUR12	Surfonic L12-12	Huntsman	C10-12 alcohol ethoxylate 12 EO

64725-903 (D)

178

SUR50	Surfonic AGM-50	Huntsman	Alkyl etheramine ^c
SUR6	Surfonic L12- 6	Huntsman	C10-12 alcohol ethoxylate 6 EO
SUR9	Surfonic TDA- 9	Huntsman	Tridecyl alcohol 9 EO
T003A	B-1910-03 A		Tallowamine + 10EO
T003B	B-1910-03 B		Tallowamine + 15EO
T003C	B-1910-03 C		Tallowamine + 20EO
T003D	B-1910-03 D		Tallowamine + 25EO
T003E	B-1910-03 E		Tallowamine + 30EO
T23E2	T23E1PAE2	Tomah	Etheramine with a C12-13 linear alcohol hydrophobe with 1 EO and 2 EO on the amine C12-13O(CH ₂ CH ₂)CH ₂ CH ₂ CH ₂ -N(EO) _x (EO) _y x=y=2
T23E5	T23E1PAE5	Tomah	Etheramine with a C12-13 linear alcohol hydrophobe with 1 EO and 5 EO on the amine C12-13O(CH ₂ CH ₂)CH ₂ CH ₂ CH ₂ N(EO) _x (EO) _y x=y=5
TAM12	Tomadol 25- 12		C12-C15 alcohol ethoxylate (11.9EO)
TED5	E-D-17-5	Tomah	C13O(CH ₂) ₃ N(EO) _x (CH ₂) ₃ N(EO) _y (EO) _z x+y+z=5
TER9	Tergitol 15 S- 9		Ethoxylated (9EO) C11-15 secondary alcohol
TPA0E	DPA-400E	Tomah	Polyethylene glycol 400 converted to a dietheramine (NH ₂)(CH ₂) ₃ O(CH ₂ CH ₂) _n (CH ₂) ₃ -(NH ₂)

64725-903 (D)

179

TPAE6	NDPA-14-E6	Tomah	hexamethylenediol converted into a symmetrical di-etheramine and ethoxylated with 6 EO (Tomah NDPA with 6 EO)
TQ14	Q14-M3	Tomah	trimethylisodecyloxypropylamine chloride (quaternary etheramine)
TQ17	Q17-M3	Tomah	trimethylisotridecyloxypropylamine chloride (quaternary etheramine)
VAR02	Varonic K-202	Witco	Ethoxylated coco amine 2EO
VAR05	Varonic K-205	Witco	Ethoxylated coco amine 5EO
WEX5	Experimental B1910-5	Witco	N-dedecyloxypropyl-1,3 diaminopropane 3.4 EO
WEX6	Experimental B1910-6	Witco	N-dedecyloxypropyl-1,3 diaminopropane 6.1 EO
WEX7	Experimental B1910-7	Witco	N-dedecyloxypropyl-1,3 diaminopropane 9.5 EO
WIT05	Witcamine TAM 105	Witco	Ethoxylated tallow amine 10 EO
WIT305	Witcamine TAM 305	Witco	Coco amine 5 EO
WIT60	Witcamine TAM 60		Ethoxylated tallow amine 6 EO
WIT80	Witcamine TAM 80	Witco	Ethoxylated tallow amine 8 EO

Except where otherwise indicated, the aqueous spray composition were prepared by mixing the surfactant with the appropriate amount of potassium glyphosate added as a 47.5% (w/w) a.e. solution. The composition was placed in a water bath at 55 °C to 60 °C for about 30 minutes until a clear homogeneous solution was obtained. In some compositions the surfactant was melted before mixing.

64725-903 (D)

180

The following procedure was used for testing compositions of the Examples to determine herbicidal effectiveness, except where otherwise indicated.

Seeds of the plant species indicated were planted in 88 mm square pots in a soil mix which was previously sterilized and prefertilized with a 14-14-14 NPK slow release fertilizer at a rate of 3.6 kg/m³. The pots were placed in a greenhouse with sub-irrigation. About one week after emergence, seedlings were thinned as needed, including removal of any unhealthy or abnormal plants, to create a uniform series of test pots.

The plants were maintained for the duration of the test in the greenhouse where they received a minimum of 14 hours of light per day. If natural light was insufficient to achieve the daily requirement, artificial light with an intensity of approximately 475 microeinsteins was used to make up the difference. Exposure temperatures were not precisely controlled but averaged about 29 °C during the day and about 21 °C during the night. Plants were sub-irrigated throughout the test to ensure adequate soil moisture levels.

Pots were assigned to different treatments in a fully randomized experimental design with 6 replications. A set of pots was left untreated as a reference against which effects of the treatments could later be evaluated.

Application of glyphosate compositions was made by spraying with a track sprayer fitted with a 9501E nozzle calibrated to deliver a spray volume of 93 liters per hectare (l/ha) at a pressure of 165 kilopascals (kPa). After treatment, pots were returned to the greenhouse until ready for evaluation.

Treatments were made using dilute aqueous compositions. These could be prepared as spray compositions directly from their ingredients, or by dilution with water of preformulated concentrate compositions.

For evaluation of herbicidal effectiveness, all plants in the test were examined by a single practiced technician, who recorded percent control, a visual measurement of the effectiveness of each treatment by comparison with untreated plants. Control of 0% indicates no effect, and control of 100% indicates that all of the plants are completely dead. The reported % control

64725-903 (D)

181

values represent the average for all replicates of each treatment.

Example 1

Aqueous concentrate compositions were prepared containing glyphosate salt and excipient ingredients as shown in Table 1a.

TABLE 1a

Comp.	Sal t	g /l	Component 1	g/l	Component 2	g/l
734A9M	K	30	S16	4.5	PG069	5.5
734B3K	K	30	S60	4.7	PG069	5.3
734C1A	K	30	S21	5.0	PG069	5.0
734D6O	K	30			PG069	10.0
734E9D	K	4.3	S16	1.4		
734F2H	K	30	S60	10.0		
734G9	K	30	S21	10.0		
W						

Velvetleaf (*Abutilon theophrasti*, ABUTH) and Japanese millet (*Echinochloa crus-galli*, var. *frumentae* ECHCF) plants were grown and treated by the standard procedures above. The compositions of Table 1a and comparative compositions 139, 553 and 360 were applied. Results, averaged for all replicates of each treatment, are shown in Table 1b and 1c.

64725-903 (D)

182

TABLE 1b: ABUTH % Control

Composition	75 g a.e./ha	150 g a.e./ha	225 g a.e./ha	300 g a.e./ha
139	0	62.5	75.8	80.8
360	45.0	81.7	85.0	91.7
553	64.2	85.0	85.8	90.0
734A9M	0	60.8	77.5	84.2
734B3K	0	63.3	80.8	83.3
734C1A	17.5	74.2	80.8	84.2
734D6O	10.0	61.7	78.3	71.7
734E9D	30.8	68.3	81.7	83.3
734F2H	41.7	75.8	83.3	85.8
734G9W	30.0	79.2	84.2	87.5

TABLE 1c: ECHCF % Control

Composition	75 g a.e./ha	150 g a.e./ha	225 g a.e./ha	300 g a.e./ha
139	0	40.8	45.8	62.5
360	56.7	77.5	80.0	90.8
553	64.2	79.2	87.5	89.2
734A9M	53.3	71.7	83.3	87.5
734B3K	35.8	70.8	85.5	89.2
734C1A	23.3	73.3	78.3	86.5
734D6O	44.2	74.2	75.8	47.5
734E9D	24.2	66.7	68.3	73.3
734F2H	16.7	54.2	68.3	73.3
734G9W	12.5	59.2	67.5	71.7

Results for ABUTH and ECHCF: Compositions 734F2H, and 734G9W exhibited similar herbicidal effectiveness to comparative composition 360 on velvetleaf (ABUTH).

64725-903 (D)

183

Example 2

Aqueous concentrate compositions were prepared containing glyphosate salt and excipient ingredients as shown in Table 2a.

TABLE 2a

Comp.	Sal t	g/l	Component 1	g/l	Component 2	g/l
736A4D	K	30	S16	2.6	S22	7.4
736B7S	K	30	S09	2.8	S22	7.2
736C8B	K	30	S18	3.0	S22	7.0
736D5V	K	30			S22	10.0
734E1D	K	4.3	S16	1.4		
734F9A	K	30	S09	10.0		
734G3K	K	30	S18	10.0		

Velvetleaf (ABUTH) and Japanese millet (ECHCF) plants were grown and treated by the standard procedures above. The compositions of Table 2a and comparative compositions 554, 553 and 360 were applied. Results, averaged for all replicates of each treatment, are shown in Table 2b and 2c.

64725-903 (D)

TABLE 2b

184

ABUTH % Control

Composition	75 g a.e./ha	150 g a.e./ha	225 g a.e./ha	300 g a.e./ha
554	0	8.3	41.7	55.8
360	0	58.3	81.7	86.7
553	26.3	83.3	89.2	94.2
736A4D	0	25	52.5	61.7
736B7S	0	45	65.8	74.2
736C8B	4.2	31.7	65	80.8
736D5V	0	5.8	50.8	64.2
734E1D	0	32.5	66.7	75.8
734F9A	0	44.2	68.3	77.5
734G3K	0	42.5	70	78.3

TABLE 2c

ECHCF % Control

Composition	75 g a.e./ha	150 g a.e./ha	225 g a.e./ha	300 g a.e./ha
554	0	8.3	18.3	39.2
360	10.8	71.7	75	79.2
553	30	71.7	79.2	91.7
736A4D	13.3	46.7	65	69.2
736B7S	0	58.3	67.5	70
736C8B	0	58.3	66.7	75.8
736D5V	0	26.7	53.3	67.5
734E1D	46.7	63.3	70	71.7
734F9A	3.3	48.3	55.8	70
734G3K	0	28.3	62.5	68.3

Results for ABUTH and ECHCF: All of the compositions exhibited less herbicidal effectiveness than comparative compositions 360 and 553 on ABUTH and ECHCF.

64725-903 (D)

185

Example 3

Aqueous concentrate compositions were prepared containing glyphosate salt and excipient ingredients as shown in Table 3a.

TTBLE 3a

Comp.	Sal t	g/l	Componen t 1	g/l	Component 2	g/l
664A5A	K	540	M121	135.02		
687A1J	K	540	M121	101.26	S23	33.75
687B8S	K	540	M121	89.92	S23	44.96
687C8L	K	540	M121	67.50	S23	67.50
688D3F	K	540	M121	101.27	S24	33.76
688E2M	K	540	M121	89.91	S24	44.96
688F9D	K	540	M121	67.51	S24	67.51
360		360				
754		445				

Velvetleaf (ABUTH) and Japanese millet (ECHCF) plants were grown and treated by the standard procedures above. The compositions of Table 3a and comparative compositions 139, 554, 754 and 360 were applied. Results, averaged for all replicates of each treatment, are shown in Table 3b and 3c.

64725-903 (D)

186

TABLE 3b: ABUTH % Control

Composition	75 g a.e./ha	100 g a.e./ha	150 g a.e./ha	200 g a.e./ha
139	16.7	40.0	61.7	73.3
554	9.2	30.0	47.5	60.0
360	66.7	71.7	92.7	96.3
664A5A	35.0	42.5	74.2	86.8
687A1J	21.7	40.0	55.0	82.5
687B8S	21.7	31.7	73.3	78.3
687C8L	15.8	43.3	68.3	70.0
688D3F	26.7	36.7	60.0	68.3
688E2M	18.3	43.3	51.7	73.3
688F9D	10.0	31.7	49.2	76.7
754	58.3	61.7	83.3	89.3

TABLE 3c: ECHCF % Control

Composition	75 g a.e./ha	100 g a.e./ha	150 g a.e./ha	200 g a.e./ha
139	12.5	43.3	44.2	65.8
554	6.7	26.7	50.0	53.3
360	79.2	90.0	99.2	99.2
664A5A	65.0	83.3	97.0	98.3
687A1J	60.0	81.7	88.2	99.2
687B8S	53.3	75.0	90.7	97.8
687C8L	55.8	70.0	87.5	97.7
688D3F	63.3	81.7	96.2	98.7
688E2M	60.0	80.8	96.2	93.3
688F9D	61.7	75.0	93.8	98.7
754	61.7	86.7	92.3	100.0

Example 4

Aqueous concentrate compositions were prepared containing glyphosate salt and excipient ingredients as shown in Table 4a.

64725-903 (D)

187

TABLE 4a

Comp.	Sa lt	g/l	Component 1	g/l	Component 2	g/l
735A18H	K	4.3	S16	0.5	S19	6.7
738A9J	K	30	S17	4.0	S19	6.0
738B4H	K	30	S18	4.2	S19	5.8
735D16X	K	4.3			S19	1.4
734E19H	K	4.3	S16	1.4		
737C13A	K	4.3	S17	1.4		
737D6G	K	30	S18	10.0		

Velvetleaf (ABUTH) and Japanese millet (ECHCF) plants were grown and treated by the standard procedures above. The compositions of Table 4a and comparative compositions 554, 360 and 553 were applied. Results, averaged for all replicates of each treatment, are shown in Table 4b and 4c.

TABLE 4b: ABUTH % Control

Compositio n	75 g a.e./ha	150 g a.e./ha	225 g a.e./ha	300 g a.e./ha
554	0	13.3	30.8	58.3
360	10.0	78.3	85.0	92.5
553	64.2	82.5	95.0	97.2
735A18H	25.8	57.5	78.3	87.5
738A9J	16.7	63.3	80.0	86.7
738B4H	25.8	68.3	81.7	87.5
735D16X	17.5	74.2	85.0	86.7
734E19H	15.0	42.5	70.8	81.7
737C13A	16.7	38.3	68.3	77.5
737D6G	10.0	53.3	77.5	83.3

64725-903 (D)

TABLE 4c

188

ECHCF % Control

Composition	75 g a.e./ha	150 g a.e./ha	225 g a.e./ha	300 g a.e./ha
554	0	0	19.2	28.3
360	20.8	71.7	81.7	89.2
553	65.8	75.0	84.2	90.5
735A18H	61.7	64.2	69.2	75.0
738A9J	30.0	65.0	72.5	78.3
738B4H	53.3	69.2	73.3	81.3
735D16X	38.3	40.0	65.0	70.8
734E19H	13.3	55.8	65.0	69.2
737C13A	69.2	30.0	69.2	59.2
737D6G	15.0	66.7	73.3	70.8

Example 5

Aqueous concentrate compositions were prepared containing glyphosate salt and excipient ingredients as shown in Table 5a.

TABLE 5a

Comp.	Salt	g/l	Component 1	g/l	Component 2	g/l
734A9D	K	30	S16	4.5	PG069	5.5
734B7Y	K	30	S09	4.7	PG069	5.3
734C9X	K	30	S18	5.0	PG069	5.0
734D3J	K	30			PG069	10.0
734E5G	K	4.3	S16	1.4		
734F8D	K	30	S09	10.0		
734G3H	K	30	S18	10.0		

Velvetleaf (ABUTH) and Japanese millet (ECHCF) plants were grown and treated by the standard procedures above. The compositions of Table 5a and comparative compositions 139, 360 and 553 were applied. Results, averaged for all replicates of each treatment, are shown in Table 5b and 5c.

64725-903 (D)

TABLE 5b: ABUTH % Control

189

Compositio n	75 g a.e./ha	150 g a.e./ha	225 g a.e./ha	300 g a.e./ha
139	0	62.5	75.8	80.8
360	45.0	81.7	85.0	91.7
553	64.2	85.0	85.8	90.0
734A9D	0	60.8	77.5	84.2
734B7Y	0	63.3	80.8	83.3
734C9X	17.5	74.2	80.8	84.2
734D3J	10.0	61.7	78.3	71.7
734E5G	30.8	68.3	81.7	83.3
734F8D	41.7	75.8	83.3	85.8
734G3H	30.0	79.2	84.2	87.5

TABLE 5c: ECHCF % Control

Compositio n	75 g a.e./ha	150 g a.e./ha	225 g a.e./ha	300 g a.e./ha
139	0	40.8	45.8	62.5
360	56.7	77.5	80.0	90.8
553	64.2	79.2	87.5	89.2
734A9D	53.3	71.7	83.3	87.5
734B7Y	35.8	70.8	85.5	89.2
734C9X	23.3	73.3	78.3	86.5
734D3J	44.2	74.2	75.8	47.5
734E5G	24.2	66.7	68.3	73.3
734F8D	16.7	54.2	68.3	73.3
734G3H	12.5	59.2	67.5	71.7

Results for ABUTH and ECHCF: Compositions 743F8D and 743G3H exhibited similar herbicidal effectiveness for ABUTH to comparative composition 360.

64725-903 (D)

Example 6

190

Aqueous concentrate compositions were prepared containing glyphosate salt and excipient ingredients as shown in Table 6a.

TABLE 6a

Comp.	Salt	g /l	Component 1	g/l
627A5F	K	30	S42	10.0
627B8U	K	30	S43	10.0
627C9Z	K	30	S44	10.0
627D4W	K	30	S45	10.0
627E7V	K	30	S46	10.0
627F3K	K	30	S47	10.0
627G8M	K	30	S48	10.0
627H2X	K	30	S49	10.0
627I3E	K	30	S50	10.0

Velvetleaf (ABUTH) and Japanese millet (ECHCF) plants were grown and treated by the standard procedures above. The compositions of Table 6a and comparative compositions 554, 754 and 553 were applied. Results, averaged for all replicates of each treatment, are shown in Table 6b and 6c.

64725-903 (D)

191

TABLE 6b: ABUTH % Control

Composition	75 g a.e./ha	150 g a.e./ha	225 g a.e./ha	300 g a.e./ha
554	0	12.5	26.7	60.0
754	0	76.7	85.8	90.8
553	55.8	84.2	91.7	95.7
627A5F	8.3	45.8	55.0	74.2
627B8U	3.3	54.2	77.5	87.5
627C9Z	0	21.7	52.5	81.7
627D4W	22.5	66.7	87.5	89.2
627E7V	28.3	62.5	80.0	89.2
627F3K	5.8	70.8	87.5	90.8
627G8M	10.0	75.0	81.7	90.8
627H2X	5.0	60.8	84.2	84.5
627I3E	18.3	71.7	86.7	91.7

TABLE 6c: ECHCF % Control

Composition	75 g a.e./ha	150 g a.e./ha	225 g a.e./ha	300 g a.e./ha
554	0	0	3.3	4.2
754	0	66.7	70.8	77.5
553	29.2	72.5	82.5	87.5
627A5F	5.0	39.2	49.2	52.5
627B8U	1.7	30.8	54.2	67.5
627C9Z	1.7	60.0	66.7	74.2
627D4W	37.5	65.8	66.7	74.2
627E7V	22.5	59.2	71.7	73.3
627F3K	42.5	70.0	73.3	78.3
627G8M	47.5	69.2	70.8	72.5
627H2X	34.2	65.8	73.3	80.0
627I3E	36.7	68.3	73.3	76.7

64725-903 (D)

192

Results for ABUTH and ECHCF: Compositions 627D4W and 627I3E exhibited similar herbicidal effectiveness overall to comparative composition 754.

Example 7

Aqueous concentrate compositions were prepared containing glyphosate salt and excipient ingredients as shown in Table 7a.

TABLE 7a

Comp.	Salt	g/l	Component 1	g/l	Component 2	g/l	Component 3	g/l
449A2Q	K	540	ETH12	45.00	WIT60	45.00	TAM12	45.00
449B8 W	K	540	ETH12	33.75	WIT60	50.63	TAM12	50.63
450C7U	K	540	ETH12	33.75	WIT60	45.00	TAM12	56.25
450D4C	K	540	ETH12	33.75	WIT60	56.25	TAM12	45.00
451E6H	K	540	ETH12	33.75	WIT60	61.25	TAM12	45.00
456A3B	K	480	ETH12	53.33	ETH15	53.33	TAM12	53.33
456B2O	K	480	ETH12	40.00	ETH15	60.00	TAM12	60.00
457C9S	K	480	ETH12	40.00	ETH15	53.33	TAM12	66.67
457D1A	K	480	ETH12	40.00	ETH15	66.67	TAM12	53.33
360	IPA	360						
754	IPA	445	TAM105	509	INT00	2.24		
554	K	725						

Velvetleaf (ABUTH) and Japanese millet (ECHCF) plants were grown and treated by the standard procedures above. The compositions of Table 7a and comparative compositions 554, 754 and 360 were applied. Results, averaged for all replicates of each treatment, are shown in Table 7b and 7c.

64725-903 (D)

TABLE 7b: ABUTH % Control

193

Composition	150 g a.e./ha	200 g a.e./ha	300 g a.e./ha	400 g a.e./ha
554	40.0	67.0	80.0	80.4
360	81.0	89.0	97.0	98.0
754	83.0	90.0	96.2	98.2
449A2Q	78.0	83.0	90.0	95.6
449B8W	78.0	84.0	91.0	98.2
450C7U	79.0	85.0	92.0	96.2
450D4C	77.0	82.0	92.0	96.2
451E6H	74.0	79.0	91.0	95.0
456A3B	77.0	81.0	93.0	96.2
456B2O	77.0	88.0	94.0	96.4
457C9S	76.0	84.0	93.0	97.4
457D1A	74.0	81.0	89.0	97.0

TABLE 7c: ECHCF % Control

Composition	150 g a.e./ha	200 g a.e./ha	300 g a.e./ha	400 g a.e./ha
554	44.0	54.0	57.0	62.0
360	85.0	97.0	99.6	99.8
754	83.0	95.0	99.8	99.0
449A2Q	85.0	93.0	95.2	98.2
449B8W	90.6	97.4	98.0	99.6
450C7U	83.0	91.2	96.6	98.4
450D4C	85.0	94.0	99.0	99.2
451E6H	89.0	89.0	95.8	99.6
456A3B	87.0	98.4	97.8	99.4
456B2O	84.0	95.0	98.2	99.6
457C9S	84.0	94.6	97.2	98.2
457D1A	83.0	94.6	95.4	99.4

64725-903 (D)

194

Results for ABUTH and ECHCF: Overall, the formulations of this example were slightly less efficacious than the 754 and 360 standards.

Example 8

Aqueous concentrate compositions were prepared containing glyphosate salt and excipient ingredients as shown in Table 8a.

TTBLE 8a

Comp.	Salt	g/l	Component 1	g/l	Component 2	g/l
721L9G	K	30	S51	3.0	RH010	7.0
721M7M	K	30	S51	5.0	INT00	5.0
721N3W	K	30	S52	2.2	RH010	7.8
721O9U	K	30	S52	3.8	INT00	6.2
721E2V	K	30	S51	10.0		
721F5C	K	30	S52	10.0		
721A8K	K	30			RH010	10.0
721B3N	K	30			INT00	10.0

Velvetleaf (ABUTH) and Japanese millet (ECHCF) plants were grown and treated by the standard procedures above. The compositions of Table 8a and comparative compositions 553, 139 and 360 were applied. Results, averaged for all replicates of each treatment, are shown in Table 8b and 8c.

64725-903 (D)

TABLE 8b: ABUTH % Control 195

Composition	75 g a.e./ha	150 g a.e./ha	225 g a.e./ha	300 g a.e./ha
139	0	30.8	71.7	84.2
360	13.3	82.5	88.3	92.3
553	57.5	85.8	90.8	94.7
721L9G	5.8	47.5	71.7	81.7
721M7M	13.3	43.3	75	83.3
721N3W	1.7	57.5	80.8	85
721O9U	6.7	48.3	76.7	80.8
721E2V	12.5	56.7	80	88.3
721F5C	5.8	62.5	73.3	85
721A8K	10.8	31.7	64.2	84.2
721B3N	0	28.3	58.3	80

TABLE 8c: ECHCF % Control

Compositio n	75 g a.e./ha	150 g a.e./ha	225 g a.e./ha	300 g a.e./ha
139	0	45.8	64.2	67.5
360	70	87.5	94.2	98.7
553	71.7	84	94.5	95.8
721L9G	61.7	68.3	79.8	92.8
721M7M	35.8	70	71.7	76.7
721N3W	43.3	66.7	74.2	80.8
721O9U	18.3	67.5	72.5	81.7
721E2V	66.7	80	92.3	99.8
721F5C	50	70	81.7	93.3
721A8K	35.8	70	74.2	82.5
721B3N	0	60.8	75.8	73.3

64725-903 (D)

196

Results for ABUTH and ECHCF: Overall, the formulations of this example were not as efficacious as the 360 standard.

Example 9

Aqueous concentrate compositions were prepared containing glyphosate salt and excipient ingredients as shown in Table 9a.

TABLE 9a

Comp.	Sal t	g/l	Compo nent 1	g/l	Compon ent 2	g/l	Compone nt 3	g/l
6226D	K	480	M121	160.0				
5603F	K	540	M121	135.0				
2398A	K	480	M121	120.0				
6761A	K	480	ETH12	64.0	WIT80	64.0	INT00	32.0
6773B	K	480	ETH12	48.0	WIT80	48.0	INT00	24.0
7679V	K	510	1816E	5.0	ARQ37	1.5		
7678V	K	510	1816E	5.0	ARQ37	1.5		
360	IPA	360						
754	IPA	445						
554	K	725						

Velvetleaf (ABUTH) and Japanese millet (ECHCF) plants were grown and treated by the standard procedures above. The compositions of Table 9a and comparative compositions 554, 139 and 360 were applied. Results, averaged for all replicates of each treatment, are shown in Table 9b and Table 9c.

64725-903 (D)

TABLE 9b: ABUTH % Control 197

Composition	100 g a.e./ha	150 g a.e./ha	200 g a.e./ha	300 g a.e./ha
139	0	17.5	50.0	68.3
554	0	0.8	37.5	55.0
360	23.3	65.0	80.0	90.0
754	30.0	68.3	80.0	90.8
6226D	16.7	57.5	78.3	85.0
5603F	8.3	45.0	66.7	77.5
2398A	11.7	50.0	65.8	73.3
6761A	12.5	60.0	71.7	76.7
6773B	5.0	56.7	65.0	73.3
7679V	18.3	65.3	80.0	83.3
7678V	25.0	72.5	77.5	80.8

TABLE 9c: ECHCF % Control

Composition	100 g a.e./ha	150 g a.e./ha	200 g a.e./ha	300 g a.e./ha
139	35.0	45.0	55.8	65.0
554	20.0	39.2	49.2	60.8
360	66.7	76.7	92.	93.0
754	63.3	77.5	86.7	92.5
6226D	64.2	79.2	90.0	92.8
5603F	65.8	73.3	84.2	85.0
2398A	61.7	62.5	80.0	84.2
6761A	65.0	75.0	87.5	93.0
6773B	63.3	68.3	88.2	88.8
7679V	61.7	66.7	67.5	74.2
7678V	55.0	62.5	70.8	85.0

Results for ABUTH and ECHCF: Overall, the formulations of this example were not as efficacious as the 360 and 754 standards. However, the

64725-903 (D)

198

622 and 676 formulations were close in performance to the 360 and 754 standards.

Example 10

Aqueous concentrate compositions were prepared containing glyphosate salt and excipient ingredients as shown in Table 10a.

TABLE 10a

Comp.	Salt	g/l	Component 1	g/l	Component 2	g/l
761A4S	K	4.3	S10	0.0	S61	1.4
761B2X	K	4.3	S10	0.3	S61	1.1
761C6Q	K	30	S10	4.0	S61	6.0
765L1D	K	30	S10	5.0	S61	5.0
761E9N	K	30	S10	6.0	S61	4.0
761F4D	K	30	S10	8.0	S61	2.0
761G8S	K	30	S10	10.0	S61	0.0

Velvetleaf (ABUTH) and Japanese millet (ECHCF) plants were grown and treated by the standard procedures above. The compositions of Table 10a and comparative compositions 554, 553 and 360 were applied. Results, averaged for all replicates of each treatment, are shown in Table 10b and 10c.

64725-903 (D)

TABLE 10b: ABUTH % Control 199

Composition	75 g a.e./ha	150 g a.e./ha	225 g a.e./ha	300 g a.e./ha
554	0.0	11.7	62.5	69.2
360	17.5	78.3	85.8	91.3
553	65.8	88.3	93.2	98.2
761A4S	39.2	73.3	83.3	90.0
761B2X	51.7	80.0	89.2	94.5
761C6Q	62.5	85.8	92.5	95.8
765L1D	70.8	85.8	89.7	95.3
761E9N	69.2	85.8	90.0	94.5
761F4D	77.5	89.2	92.2	94.8
761G8S	74.2	86.7	91.5	96.0

TABLE 10c: ECHCF % Control

Composition	75 g a.e./ha	150 g a.e./ha	225 g a.e./ha	300 g a.e./ha
554	0.0	0.0	5.0	33.3
360	25.0	70.8	80.8	84.2
553	64.2	78.3	85.0	83.3
761A4S	0.0	57.5	68.3	72.5
761B2X	3.3	65.8	71.7	74.2
761C6Q	29.2	71.7	76.7	78.3
765L1D	23.3	75.0	75.0	82.5
761E9N	37.5	74.2	77.5	81.7
761F4D	51.7	75.8	80.0	83.3
761G8S	60.0	75.0	82.5	85.0

DEMANDES OU BREVETS VOLUMINEUX

**LA PRÉSENTE PARTIE DE CETTE DEMANDE OU CE BREVETS
COMPREND PLUS D'UN TOME.**

CECI EST LE TOME __1__ DE __2__

NOTE: Pour les tomes additionels, veuillez contacter le Bureau Canadien des Brevets.

JUMBO APPLICATIONS / PATENTS

**THIS SECTION OF THE APPLICATION / PATENT CONTAINS MORE
THAN ONE VOLUME.**

THIS IS VOLUME __1__ OF __2__

NOTE: For additional volumes please contact the Canadian Patent Office.

WHAT IS CLAIMED IS:

1. A pesticidal composition comprising
 - (i) glyphosate or a salt or ester thereof, wherein the glyphosate is predominantly in the form of monoammonium, diammonium, sodium, monoethanolamine, n-propylamine, ethylamine, ethylenediamine, hexamethylenediamine, trimethylsulfonium or isopropylamine salt, or mixtures thereof, and
 - (ii) an agriculturally useful amount of at least one surfactant compound selected from the group consisting of:
 - (a) monoalkoxylated amines having the formula:

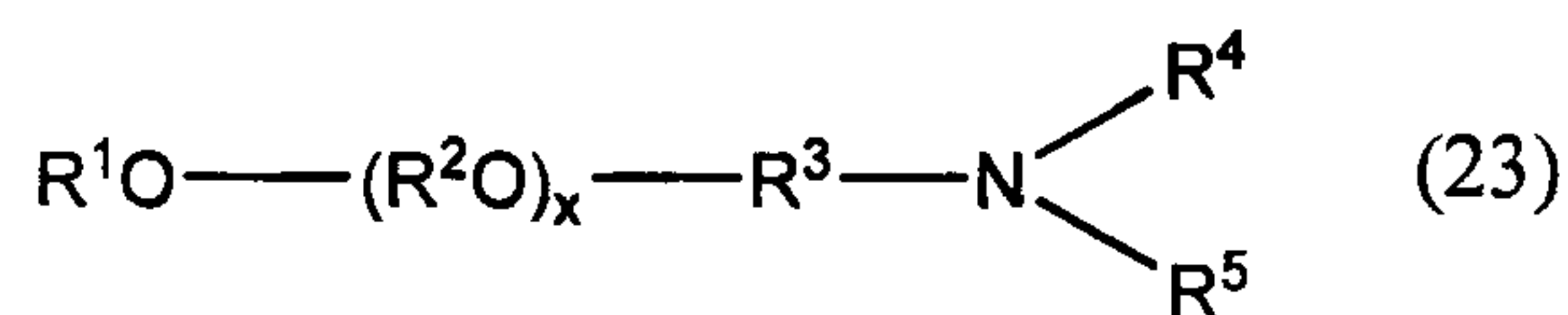

wherein R^1 is hydrocarbyl having at least 7 carbon atoms; R^2 in each of the $(R^2O)_x$ groups is independently C_{2-4} alkylene; R^3 is ethylene or propylene; R^4 and R^5 are each independently hydrogen or hydrocarbyl having from 1 to 6 carbon atoms, and x is an average number from 1 to 20;

- (b) di-poly(hydroxyalkyl)amines having the formula:

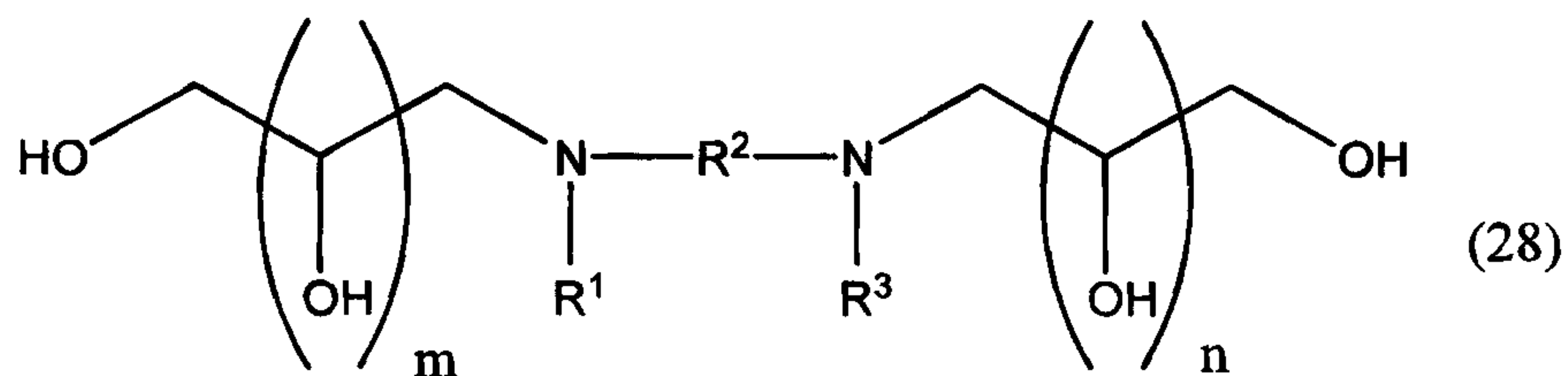

wherein R^1 and R^3 are hydrocarbyl having from 1 to 22 carbon atoms, R^2 is hydrocarbylene having from 2 to 18 carbon atoms, and m and n are independently integers from 1 to 8; and

312

(c) triamines having the formula:

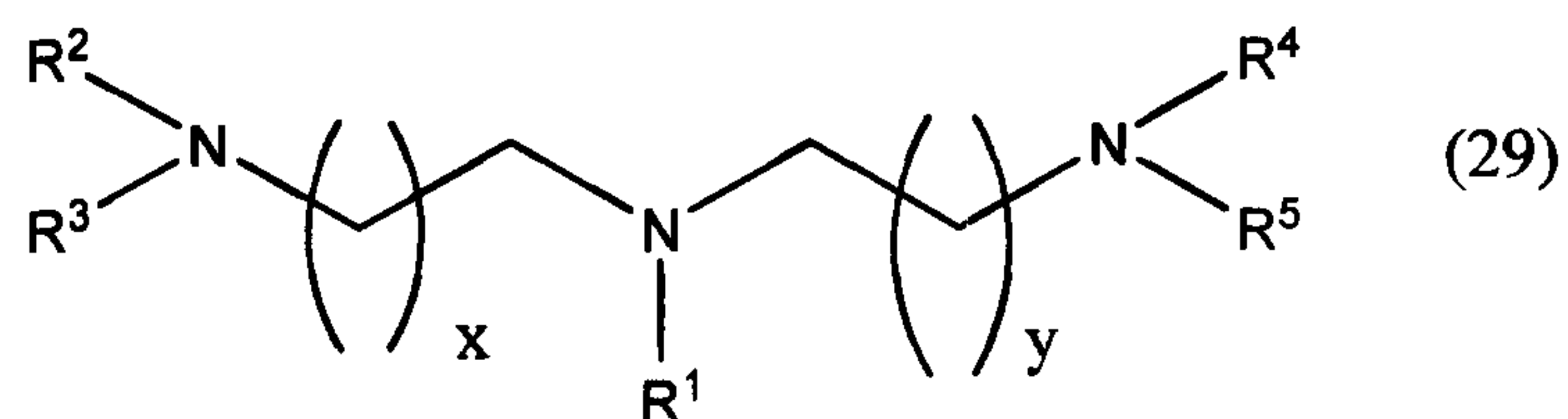

wherein R^1 is hydrocarbyl having from 8 to 18 carbon atoms; R^2 , R^3 , R^4 and R^5 are hydrogen or hydrocarbyl having from 1 to 6 carbon atoms; and x and y are independently 1 to 4.

2. The pesticidal composition of claim 1 wherein the composition is a diluted plant application treatment composition.

Application number/numéro de demande: 2510398

Figures: A1-2, B1-2

Pages: _____

Drawings

Unscannable items
received with this application
(Request original documents in File Prep. Section on the 10th Floor)

Documents reçus avec cette demande ne pouvant être balayés
(Commander les documents originaux dans la section de préparation des dossiers au
10ième étage)

