



US00D998170S

(12) **United States Design Patent**  
**Sievert et al.**

(10) **Patent No.:** **US D998,170 S**

(45) **Date of Patent:** **\*\* Sep. 5, 2023**

(54) **SAMPLE CONTAINER**

(71) Applicant: **INVEOX GMBH**, Garching bei  
Munich (DE)

(72) Inventors: **Dominik Sievert**, Munich (DE); **Maria  
Sievert**, Munich (DE)

(73) Assignee: **INVEOX GMBH**, Garching bei  
Munich (DE)

(\*\*) Term: **15 Years**

(21) Appl. No.: **29/709,044**

(22) Filed: **Oct. 10, 2019**

(30) **Foreign Application Priority Data**

Apr. 10, 2019 (EM) ..... 006372975-0001

(51) **LOC (14) Cl.** ..... **24-02**

(52) **U.S. Cl.**  
USPC ..... **D24/224**

(58) **Field of Classification Search**  
USPC ..... D24/107, 108, 112, 121, 127, 129, 133,  
D24/186, 216, 222-233; D10/78, 81,  
(Continued)

(56) **References Cited**

**U.S. PATENT DOCUMENTS**

2,790,576 A \* 4/1957 Lawrence ..... B65D 43/0222  
220/799  
D243,628 S \* 3/1977 Biondo ..... D24/224  
(Continued)

**FOREIGN PATENT DOCUMENTS**

KR 3020190059874 \* 12/2019

**OTHER PUBLICATIONS**

Intelligent Container. Online, published date unknown. Retrieved  
on Jun. 14, 2021 from URL: <https://inveox.com/product/>\*

*Primary Examiner* — Omeed Agilee

(74) *Attorney, Agent, or Firm* — Greer, Burns & Crain,  
Ltd

(57) **CLAIM**

The ornamental design for a sample container, as shown and  
described.

**DESCRIPTION**

FIG. 1 is a top perspective view of the present sample  
container;

FIG. 2 is a bottom perspective view thereof;

FIG. 3 is a front view of the sample container of FIG. 1;

FIG. 4 is a rear view thereof;

FIG. 5 is a left side view of the sample container of FIG. 1;

FIG. 6 is a right side thereof;

FIG. 7 is a top plan view of the sample container of FIG. 1;  
and

FIG. 8 is a bottom plan view thereof;

FIG. 9 is a top perspective view of a container portion of the  
present sample container;

FIG. 10 is a bottom perspective view thereof;

FIG. 11 is a front view of the container portion of FIG. 9;

FIG. 12 is a rear view thereof;

FIG. 13 is a left side view of the container portion of FIG.  
9;

FIG. 14 is a right side view thereof;

FIG. 15 is a top plan view of the container portion of FIG.  
9; and

FIG. 16 is a bottom plan view thereof;

FIG. 17 is a top perspective view of the lid portion of the  
present sample container;

FIG. 18 is a bottom perspective view thereof;

FIG. 19 is a front view of the lid portion of FIG. 17;

FIG. 20 is a rear view thereof;

FIG. 21 is a left side view of the lid portion of FIG. 17;

FIG. 22 is a right side view thereof;

FIG. 23 is a top plan view of the lid portion of FIG. 17; and,

FIG. 24 is a bottom plan view thereof.

The broken lines depict portions of the sample container that  
form no part of the claimed design.

**1 Claim, 24 Drawing Sheets**

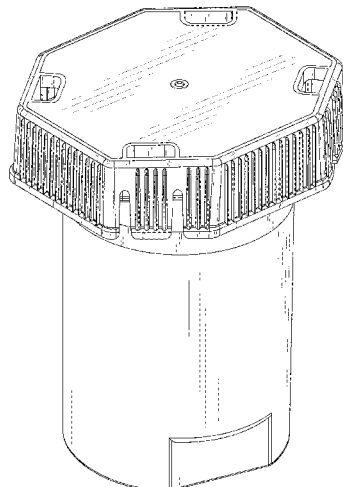

**US D998,170 S**

(58) **Field of Classification Search**

USPC ..... D10/103; D9/503, 504, 505, 529, 530,  
D9/549  
CPC ..... A61B 10/0051; A61B 10/0096; A61B  
10/007; A61B 2010/0009; B01L  
2300/0663; B01L 2200/185; B01L  
2400/06; B01L 2200/141; B01L  
2300/021; B01L 2300/0832; B01L  
2300/047; B01L 2300/069; B01L  
2400/0487; B01L 2300/0825; B01L  
2400/0481; B01L 2300/0864; B01L  
2200/025; G01N 1/31

See application file for complete search history.

(56) **References Cited**

U.S. PATENT DOCUMENTS

4,034,884 A \* 7/1977 White ..... B65D 21/08  
220/8  
D252,612 S \* 8/1979 Mull ..... D24/224

4,171,057 A \* 10/1979 Gach ..... B65D 50/048  
215/211  
D279,651 S \* 7/1985 Freeman ..... D9/446  
5,384,096 A \* 1/1995 Burns ..... C07C 19/08  
422/549  
D357,985 S \* 5/1995 Burns ..... D24/224  
D388,874 S \* 1/1998 Lewandowski ..... D24/122  
D424,440 S \* 5/2000 Wilkinson ..... D24/224  
D494,279 S \* 8/2004 Cogan ..... D24/121  
D510,270 S \* 10/2005 Khalifa ..... D9/503  
D540,679 S \* 4/2007 Tanner ..... D9/420  
D631,169 S \* 1/2011 Cheeley ..... D24/224  
D809,922 S \* 2/2018 Blagojevic ..... D9/503  
D834,950 S \* 12/2018 Aboabdo ..... D9/503  
D895,139 S \* 9/2020 Hong ..... D24/224  
D901,677 S \* 11/2020 Hong ..... D24/121  
D901,696 S \* 11/2020 Lei ..... D24/186  
D908,500 S \* 1/2021 Aboabdo ..... D9/503  
2015/0166219 A1 \* 6/2015 Bailey ..... B65D 41/0471  
215/253  
2017/0265847 A1 \* 9/2017 Cortelazzo ..... B01L 3/508  
2020/0103320 A1 \* 4/2020 Sievert ..... G01N 1/31  
2020/0398273 A1 \* 12/2020 Hacker ..... B01F 11/0005

\* cited by examiner

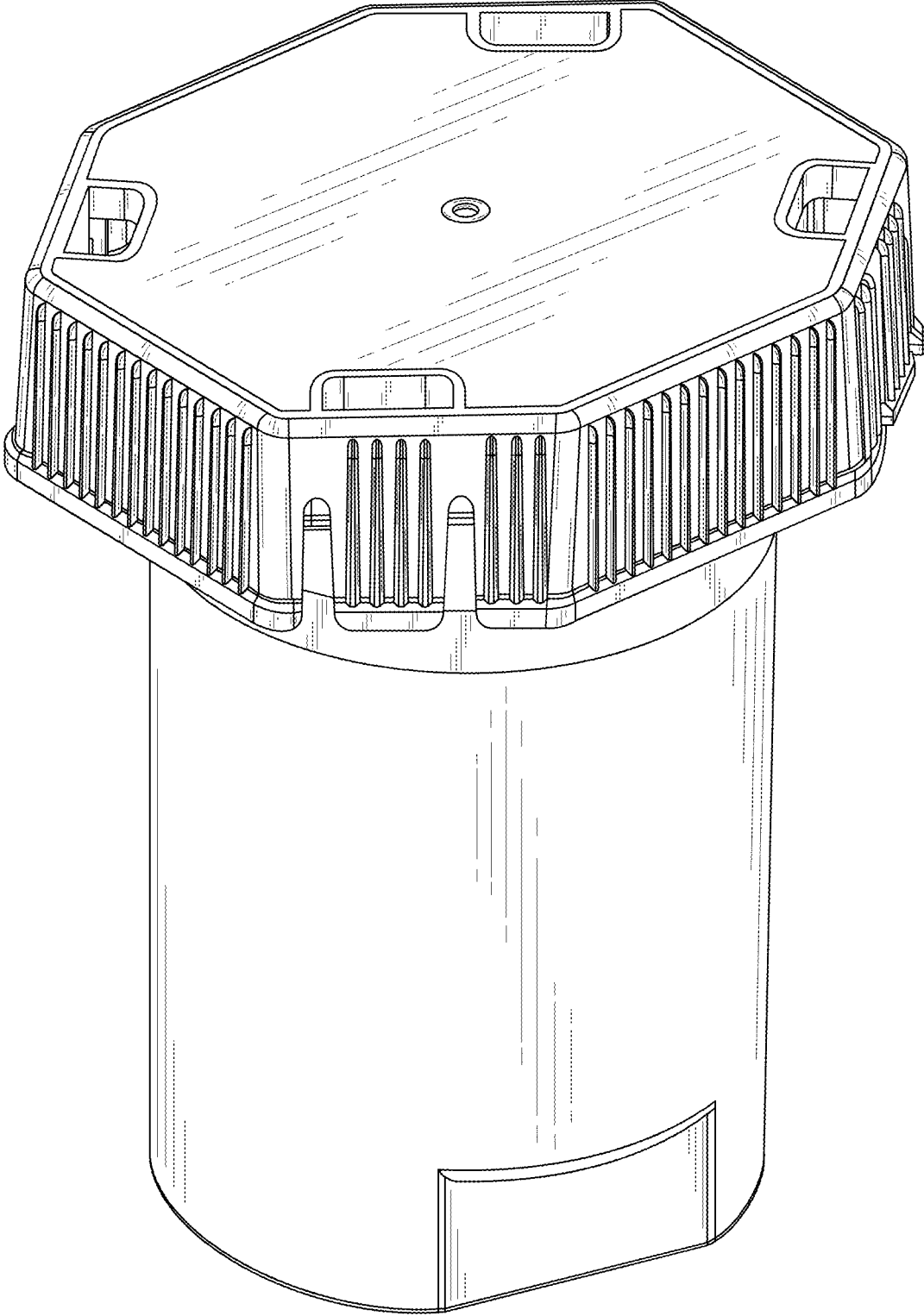

FIG. 1

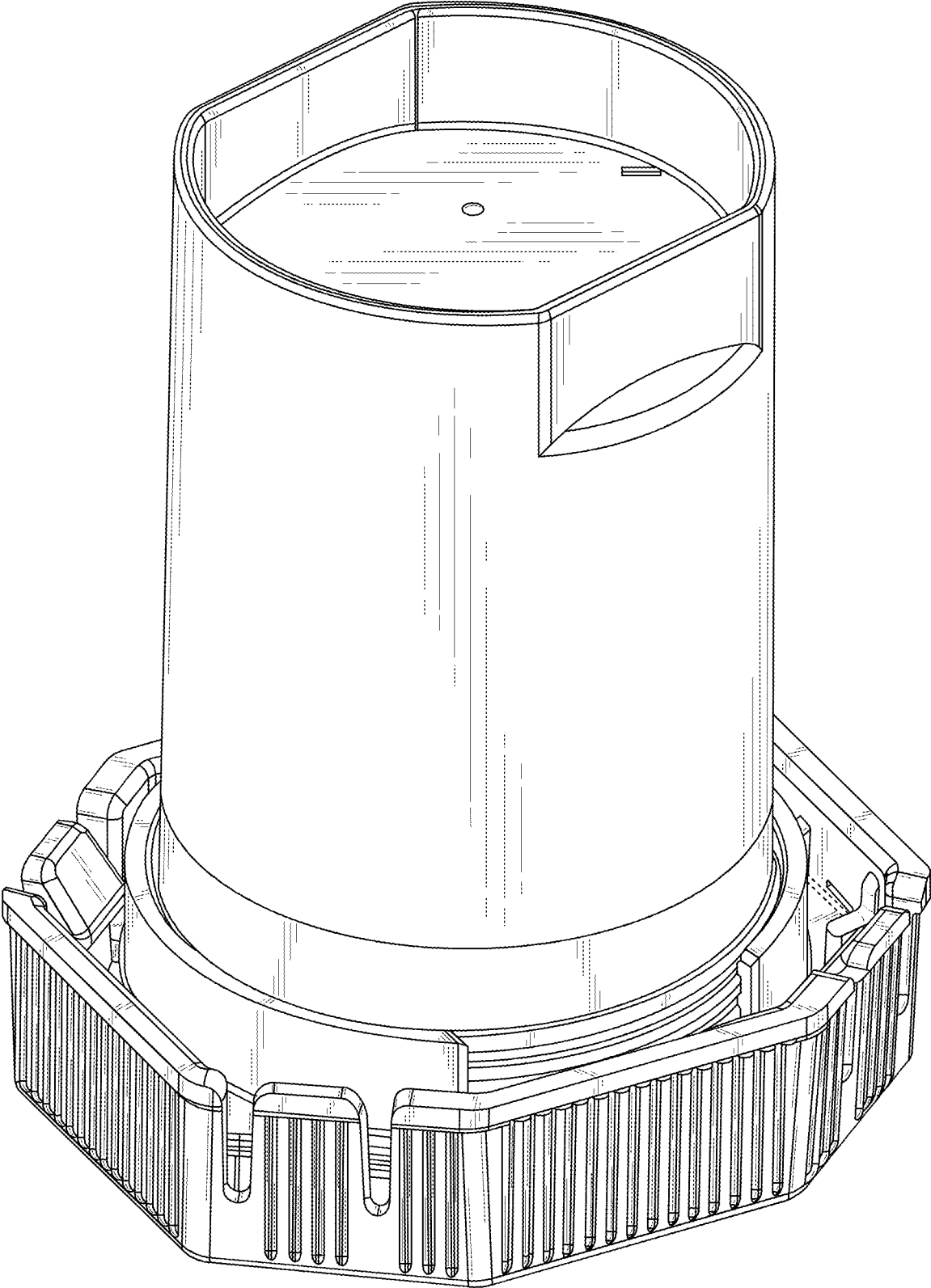

FIG. 2

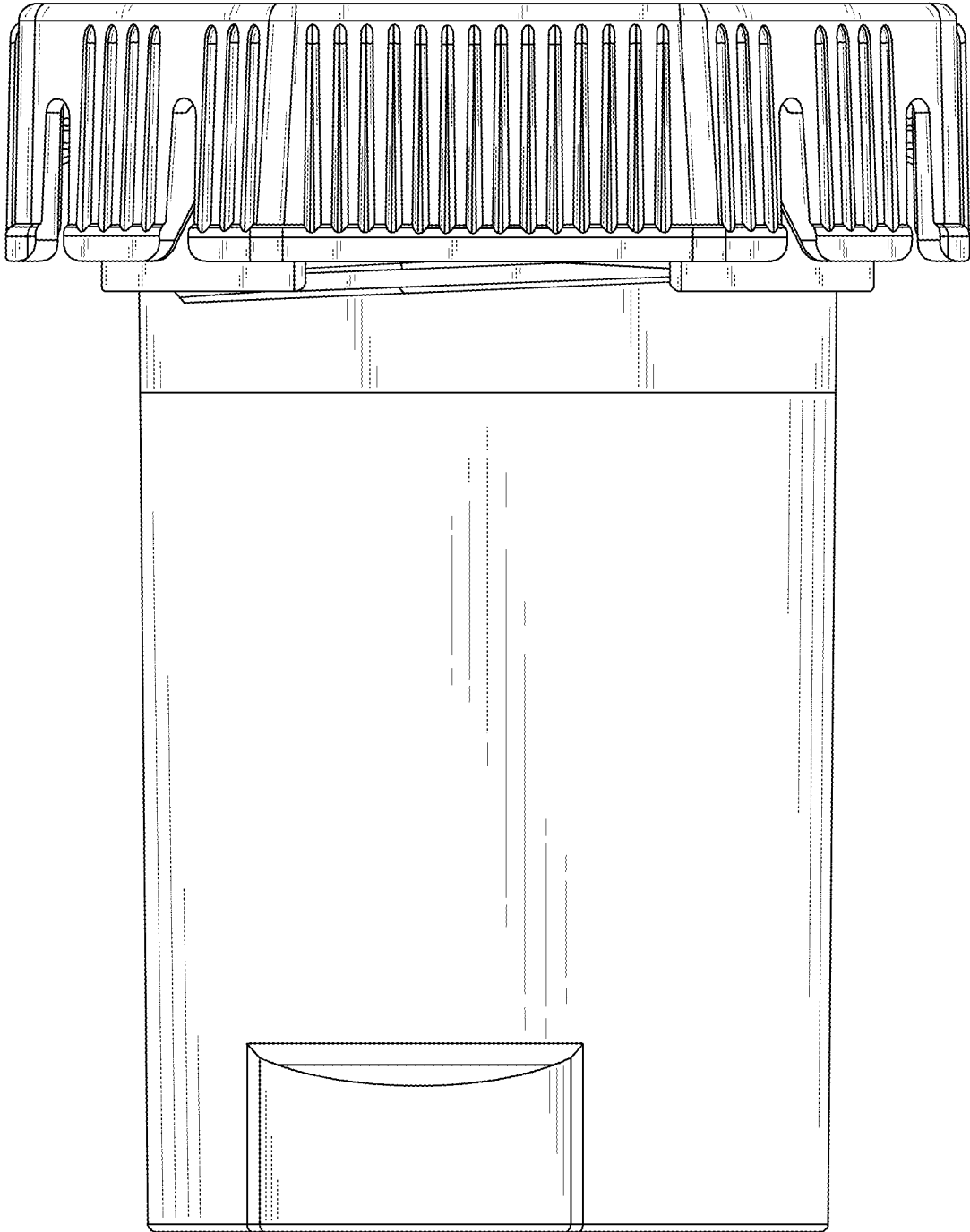

FIG. 3

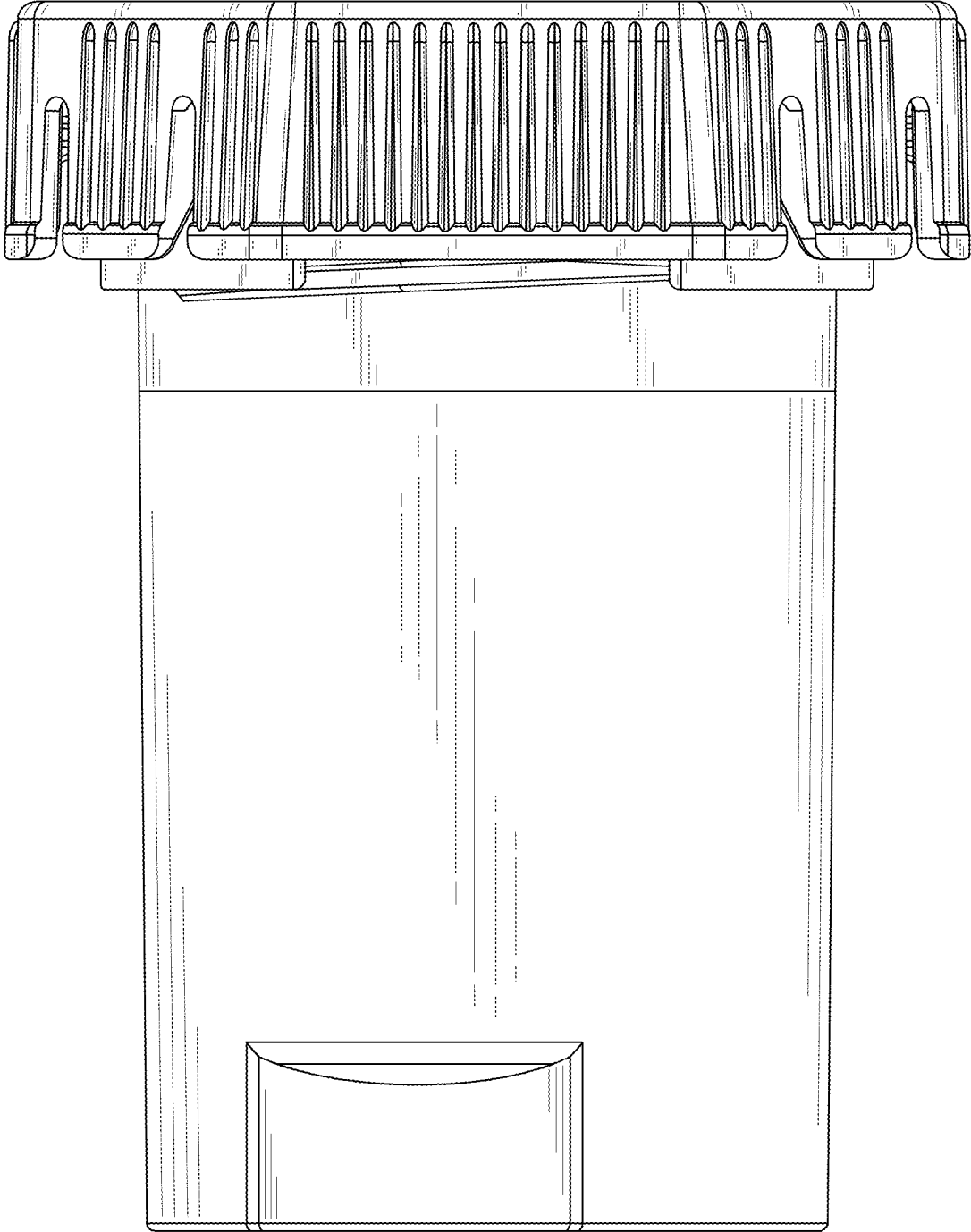

FIG. 4

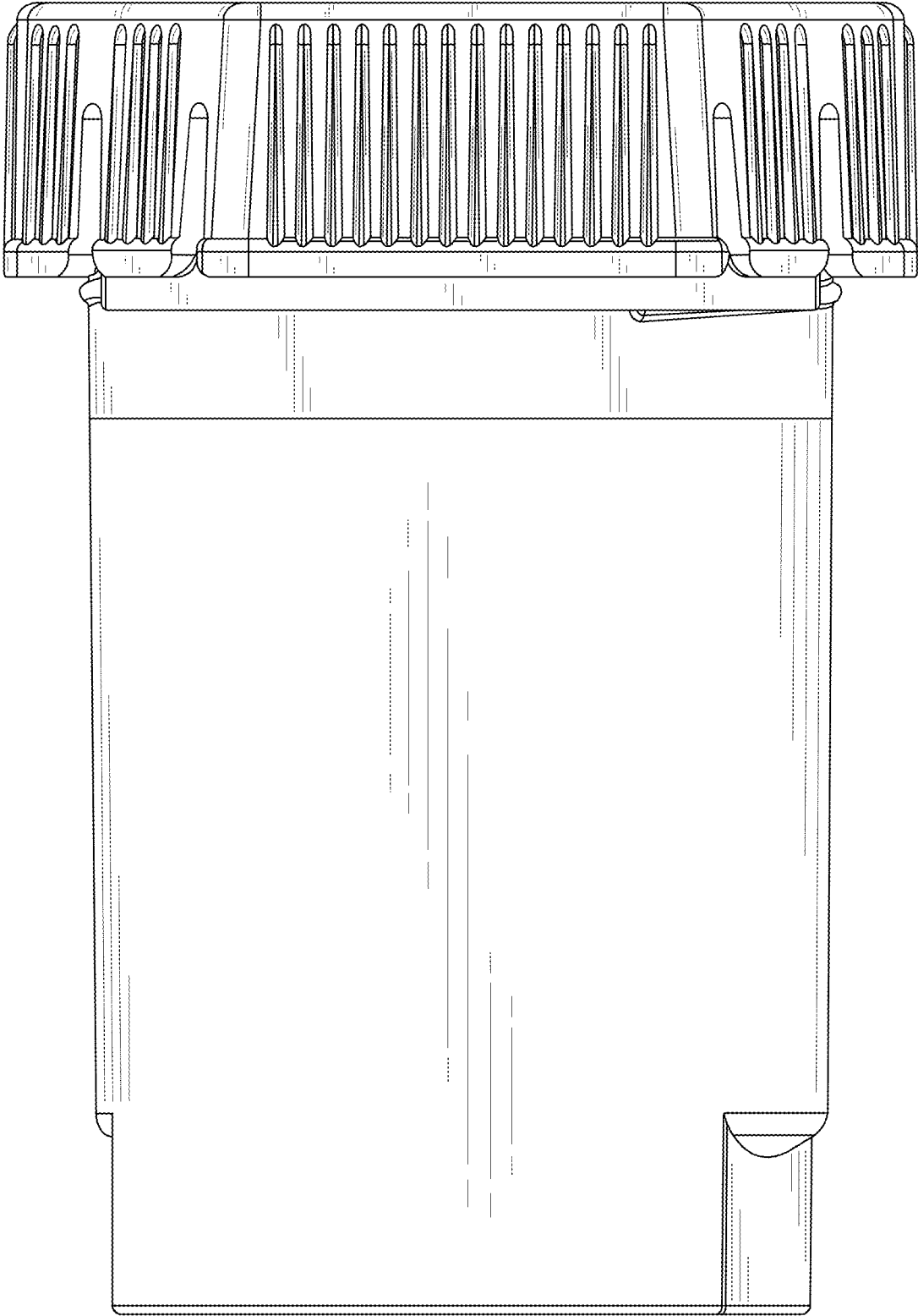

FIG. 5

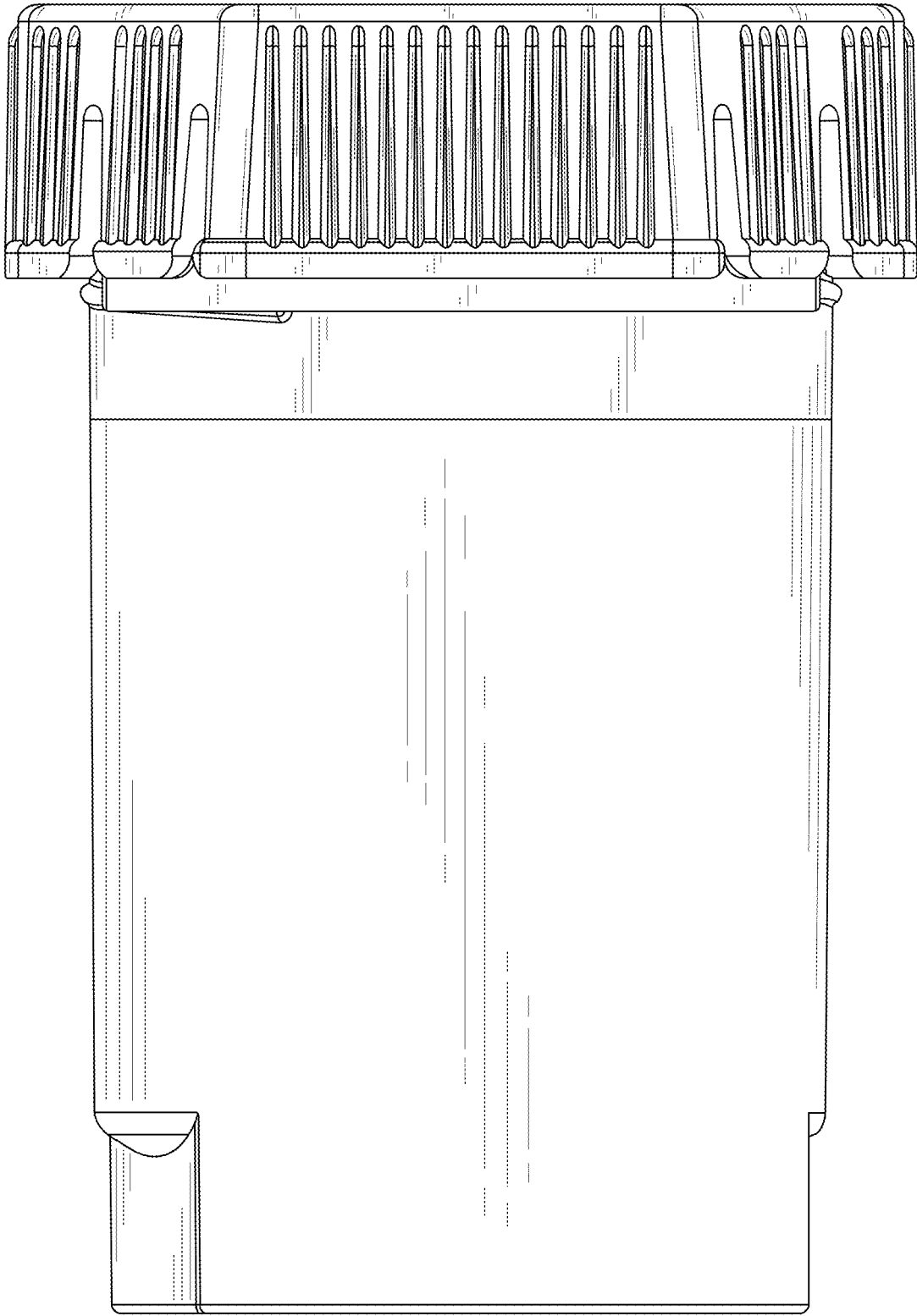

FIG. 6



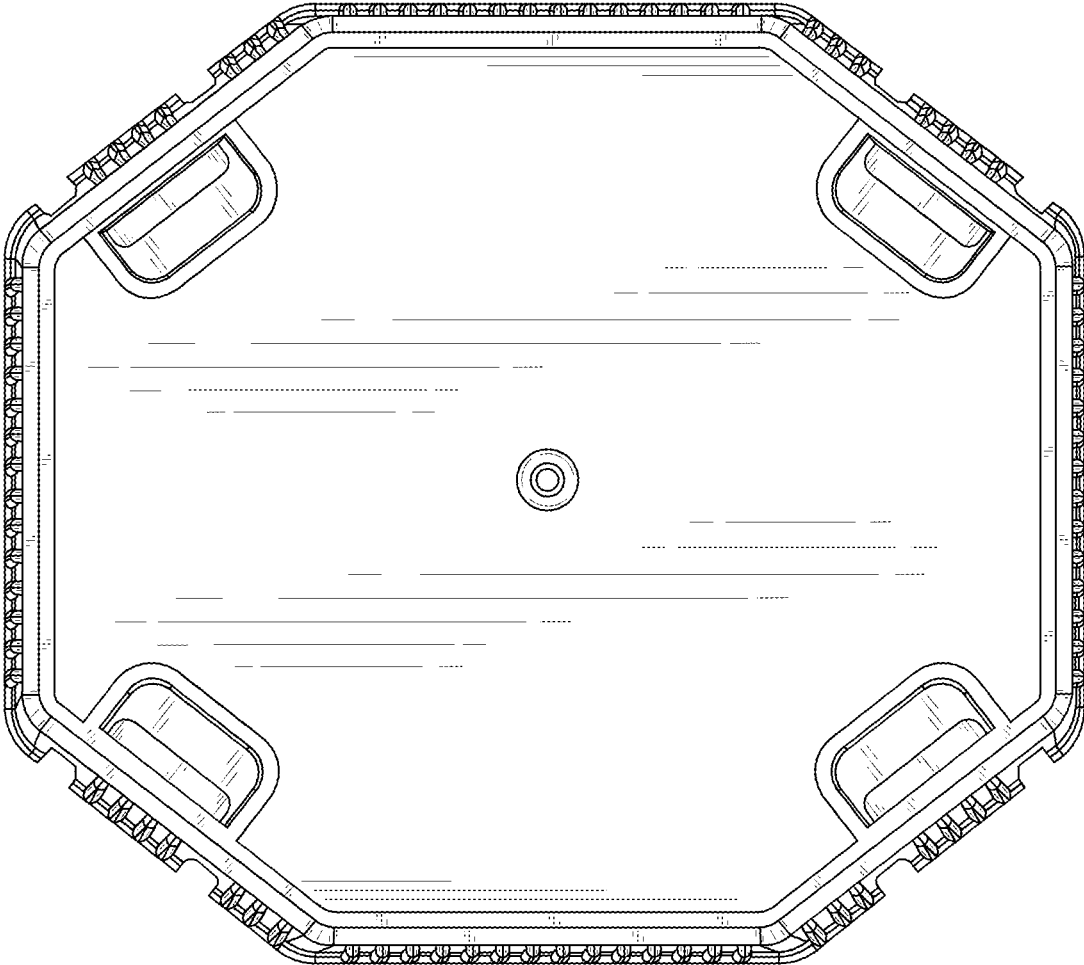

FIG. 7

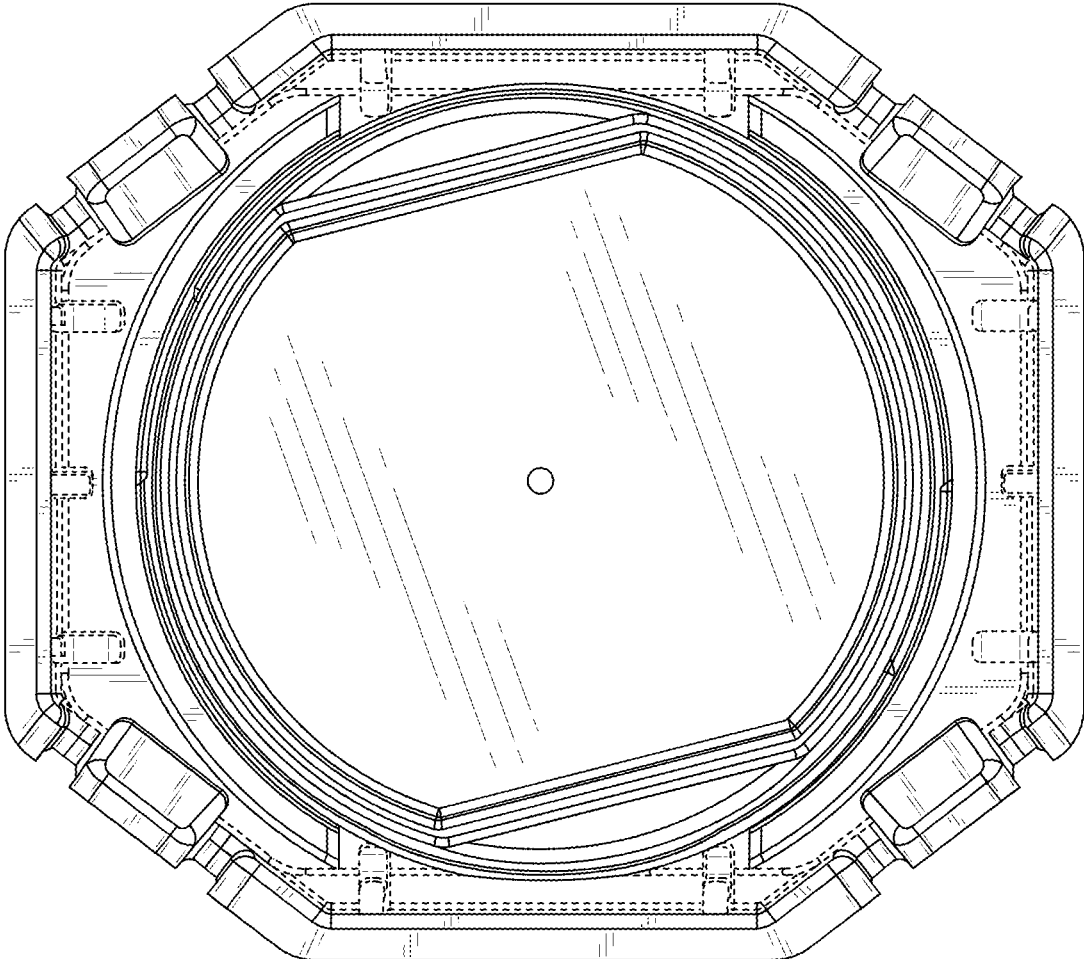

FIG. 8

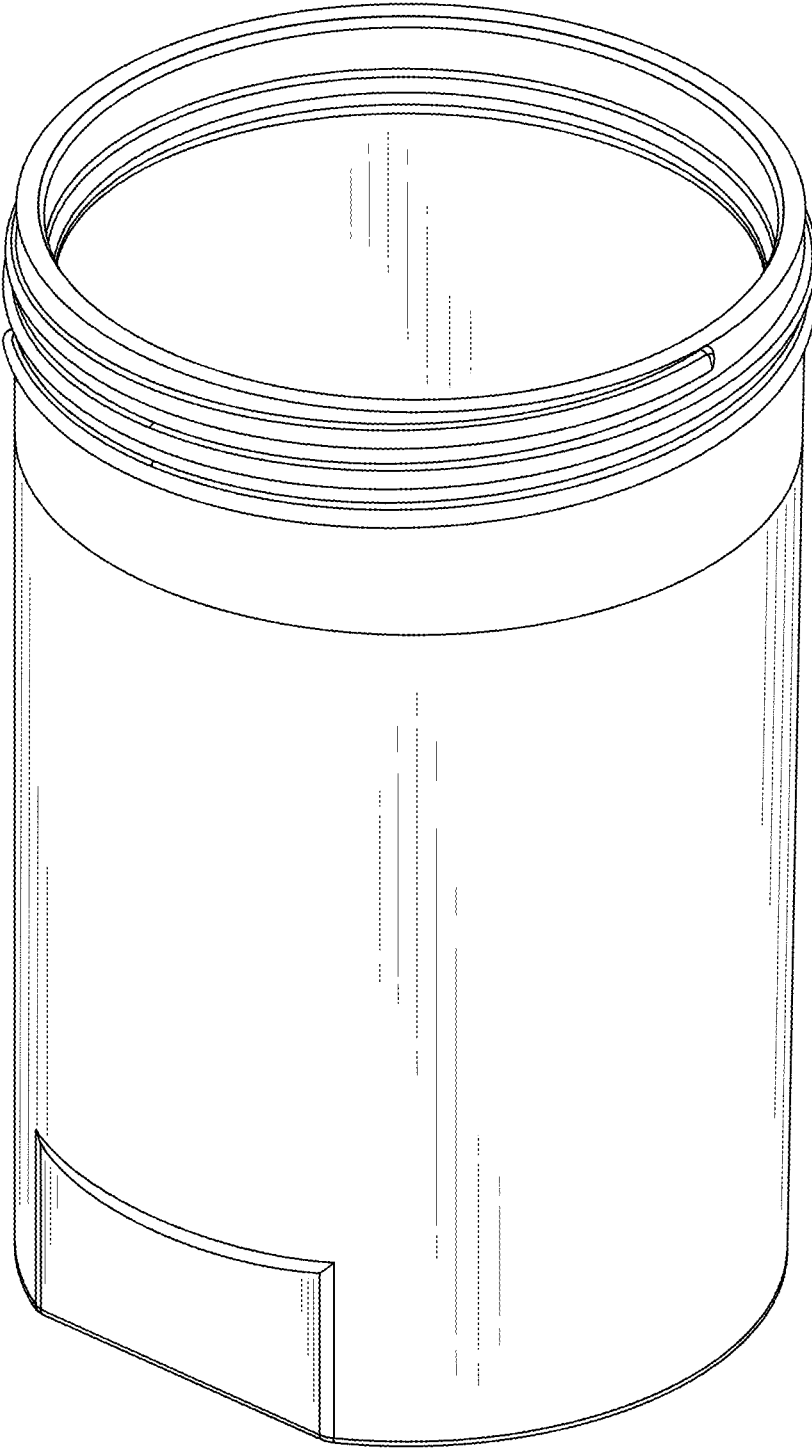

FIG. 9

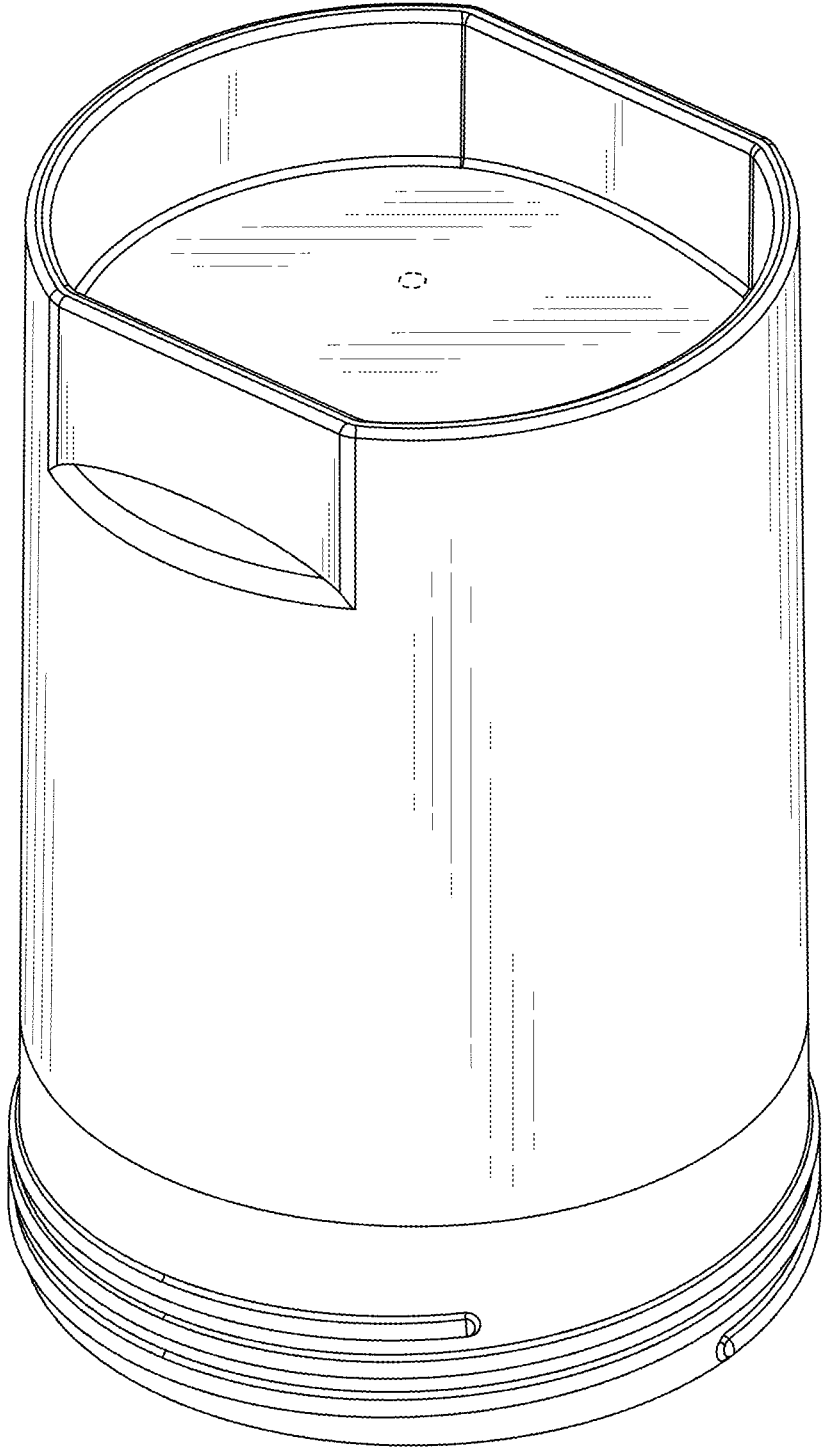

FIG. 10

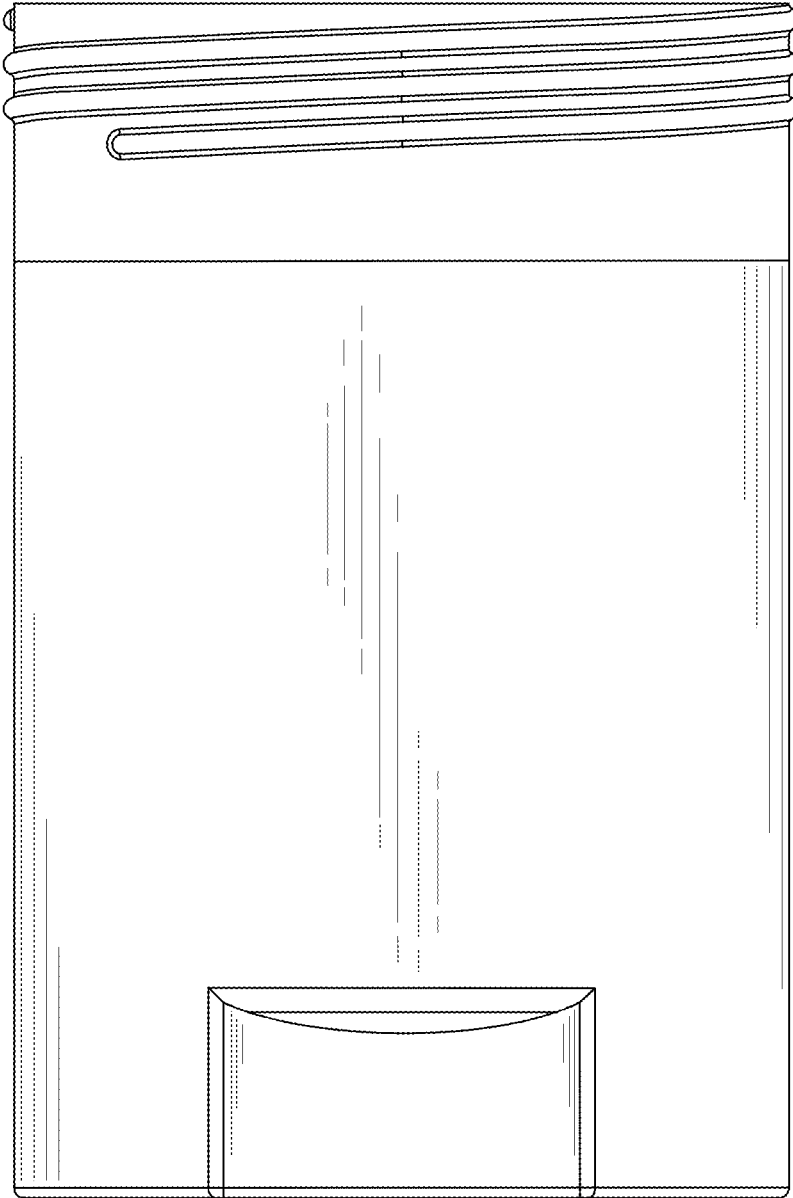

FIG. 11

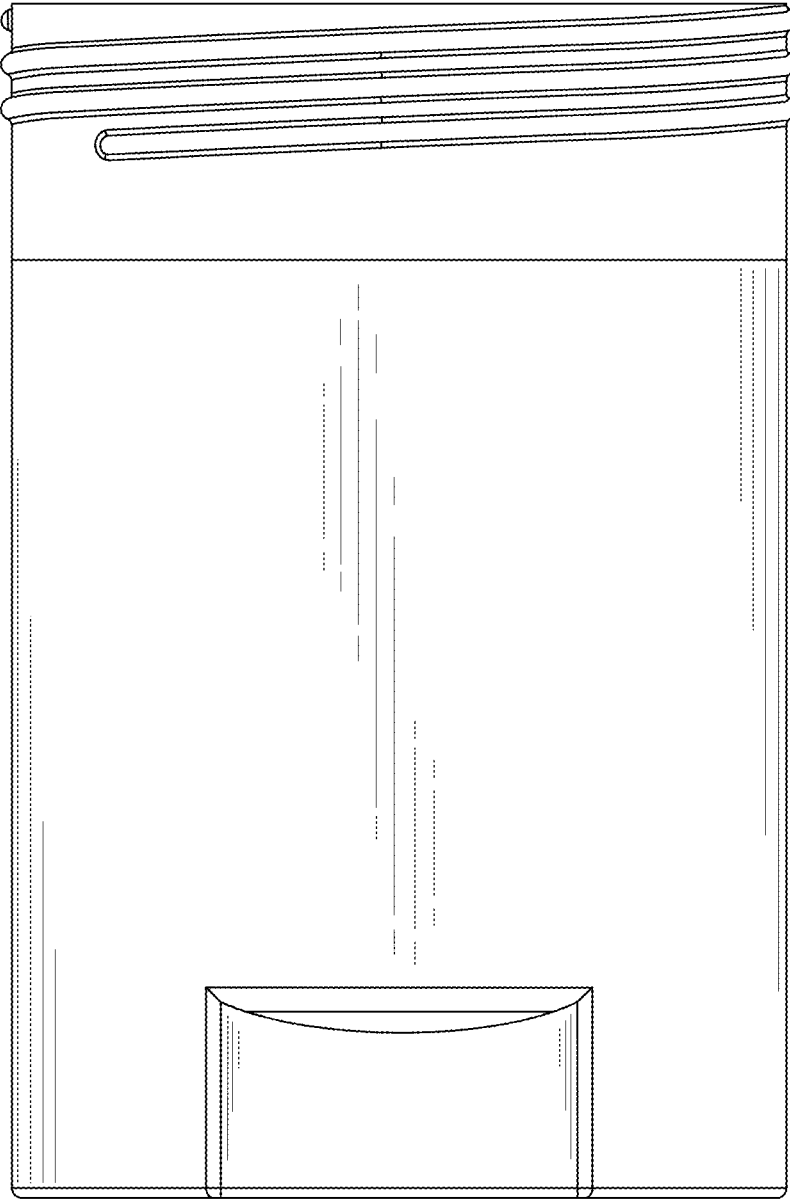

FIG. 12

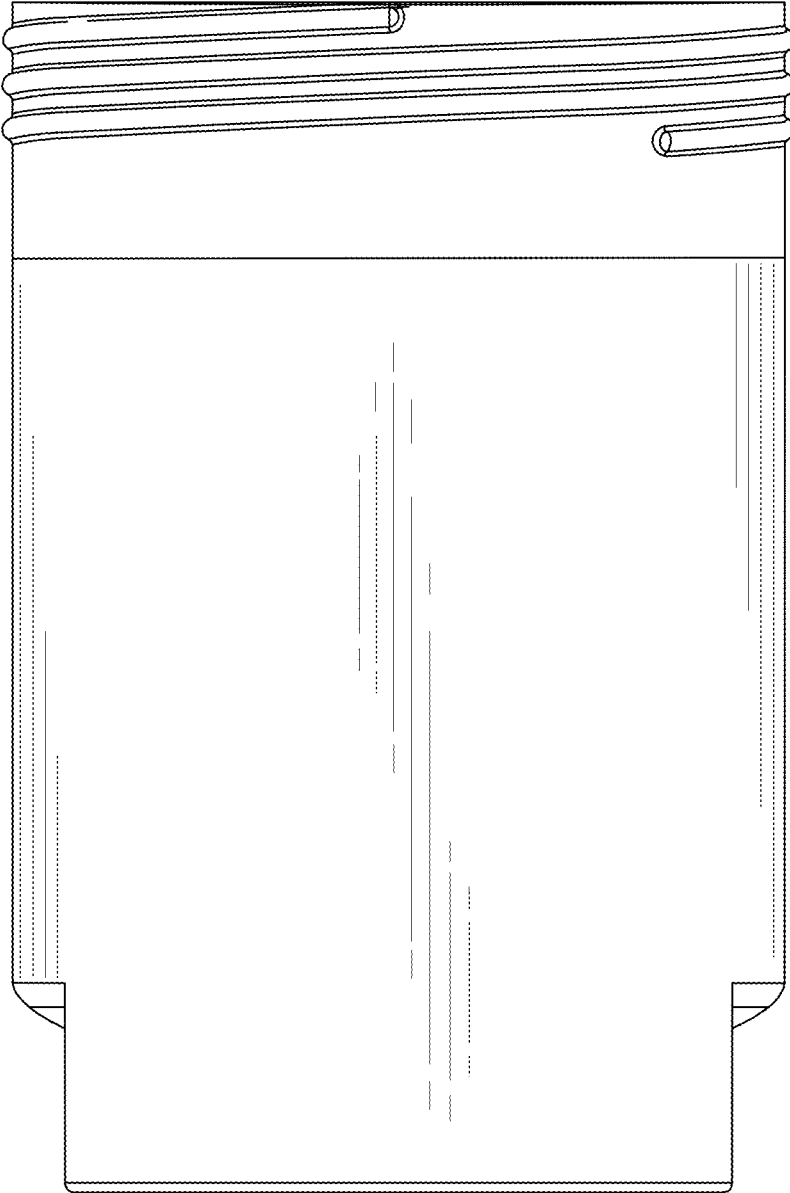

FIG. 13

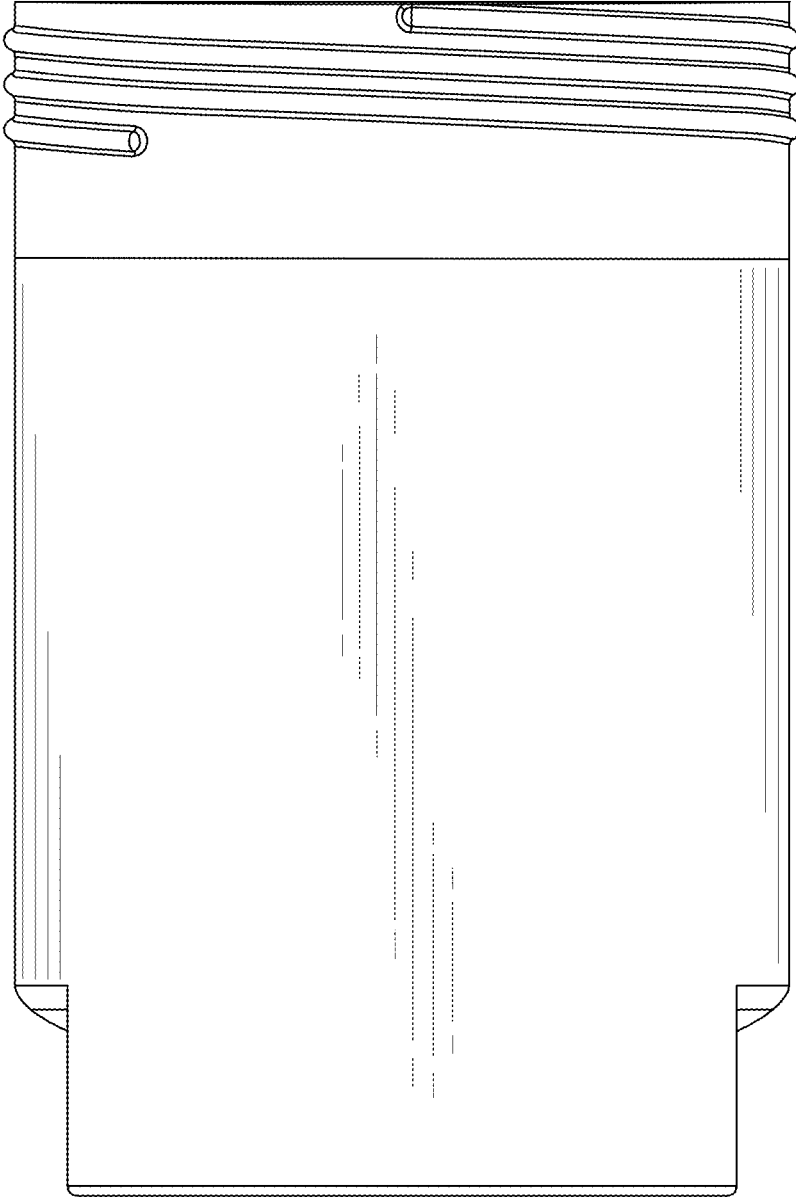

FIG. 14



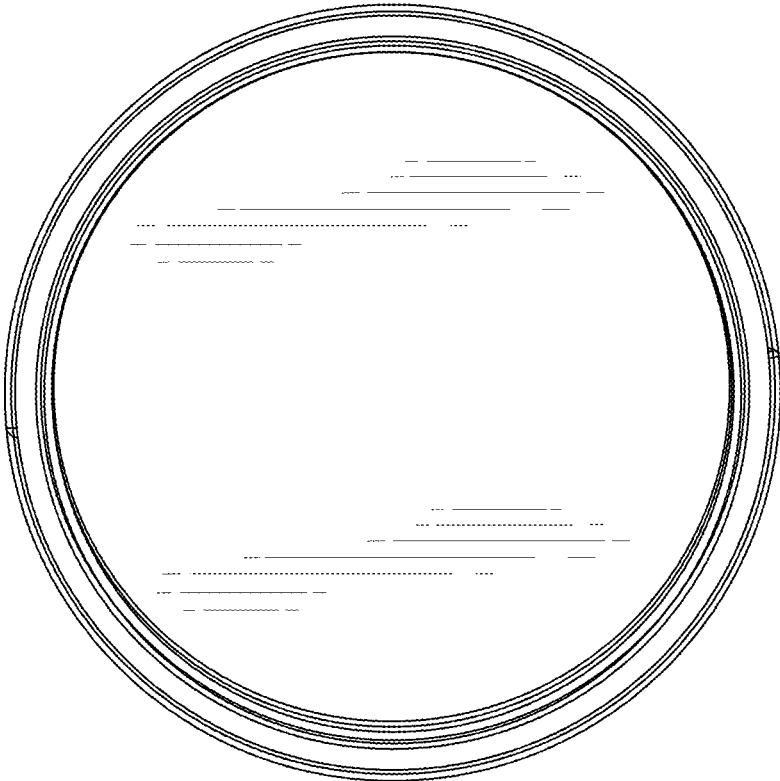

FIG. 15

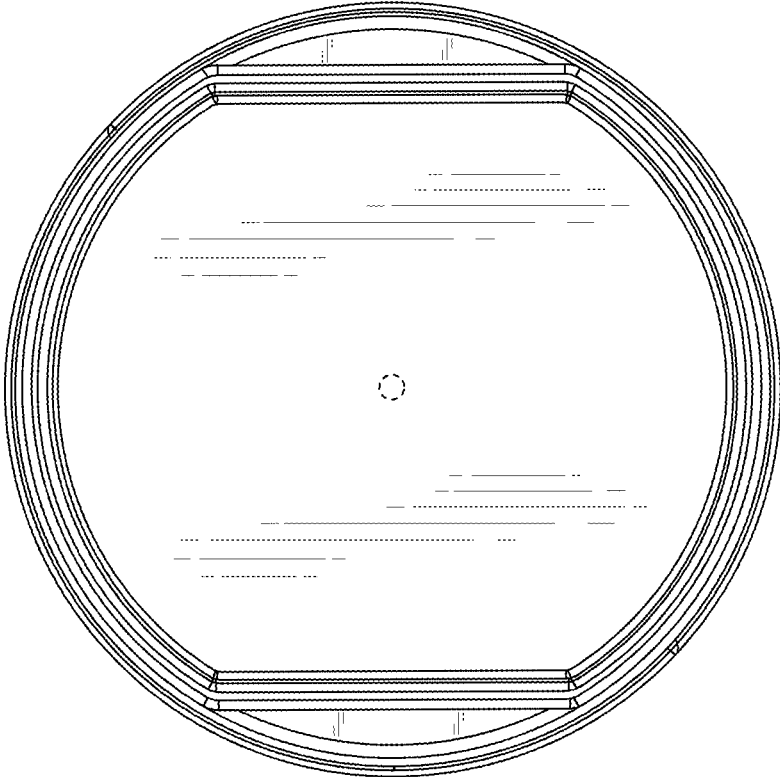

FIG. 16

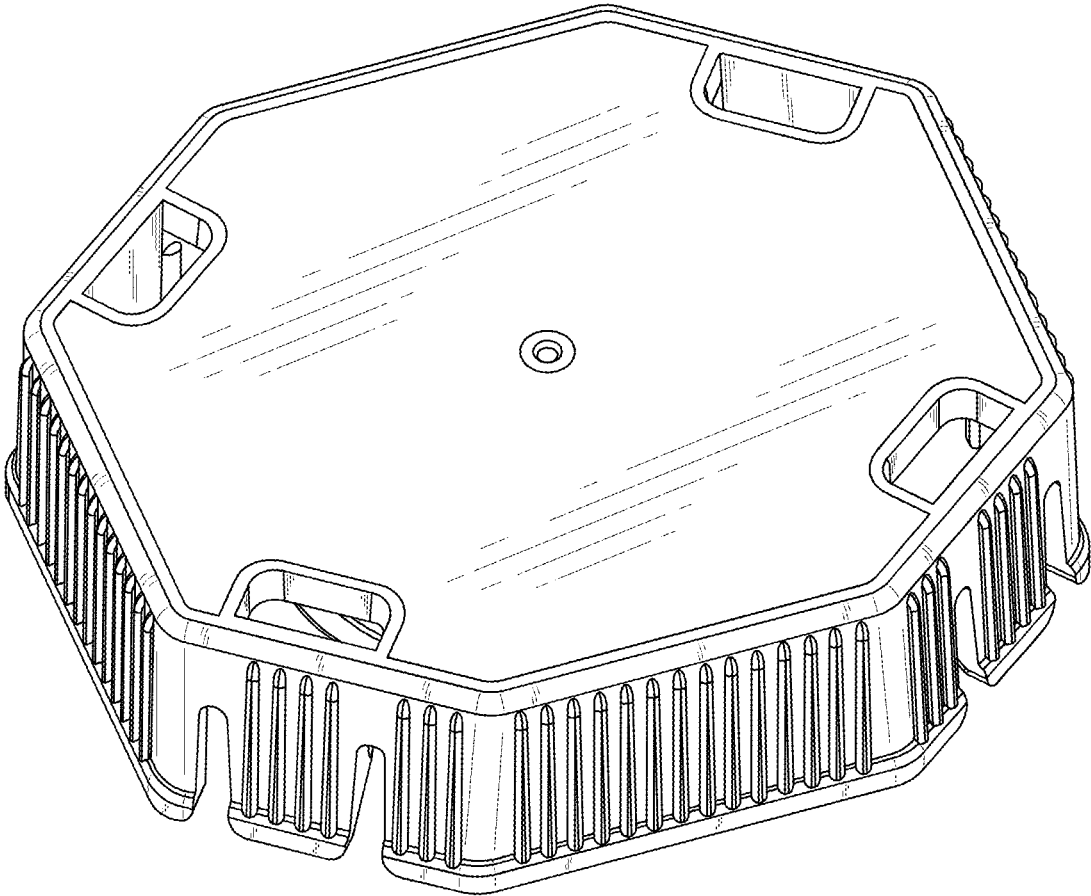

FIG. 17

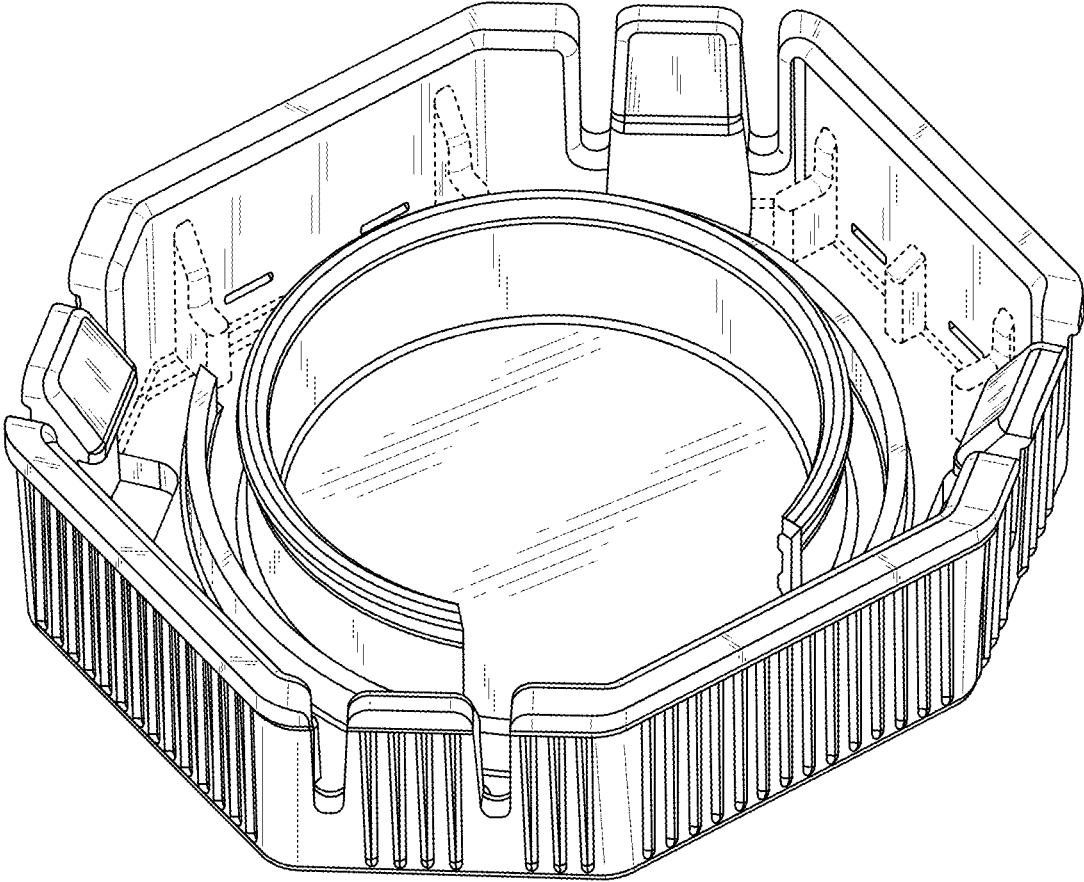

FIG. 18

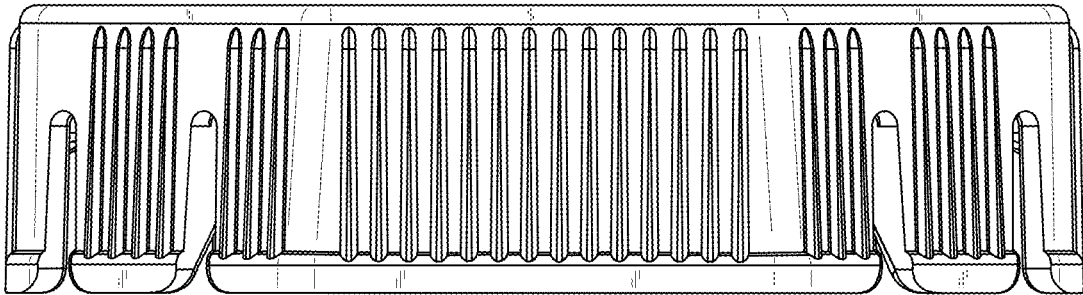

FIG. 19

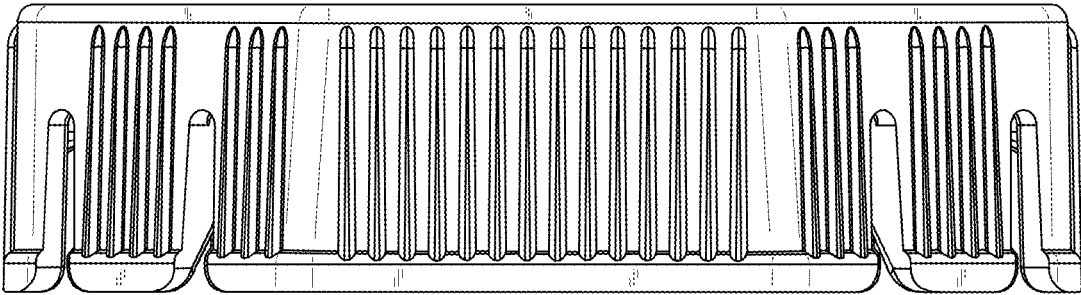

FIG. 20

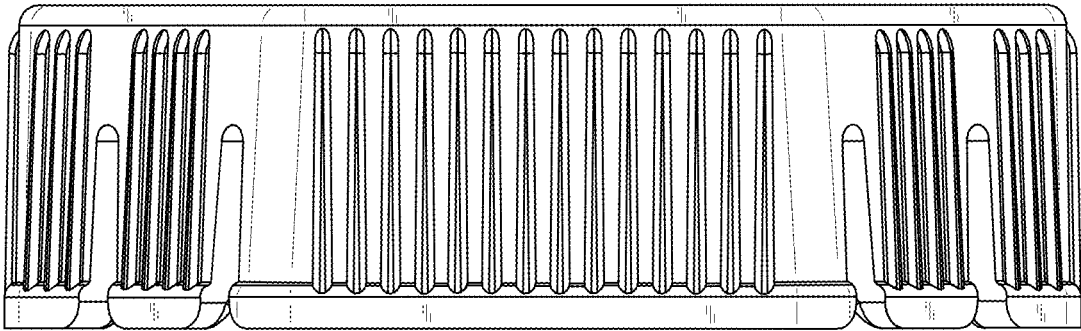

FIG. 21

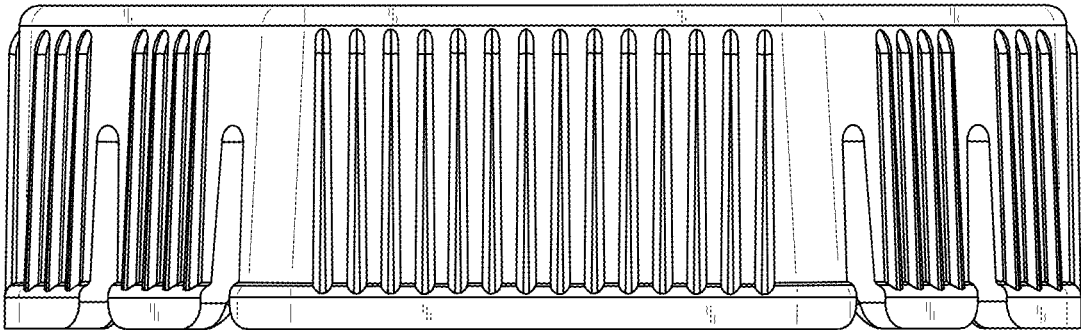

FIG. 22



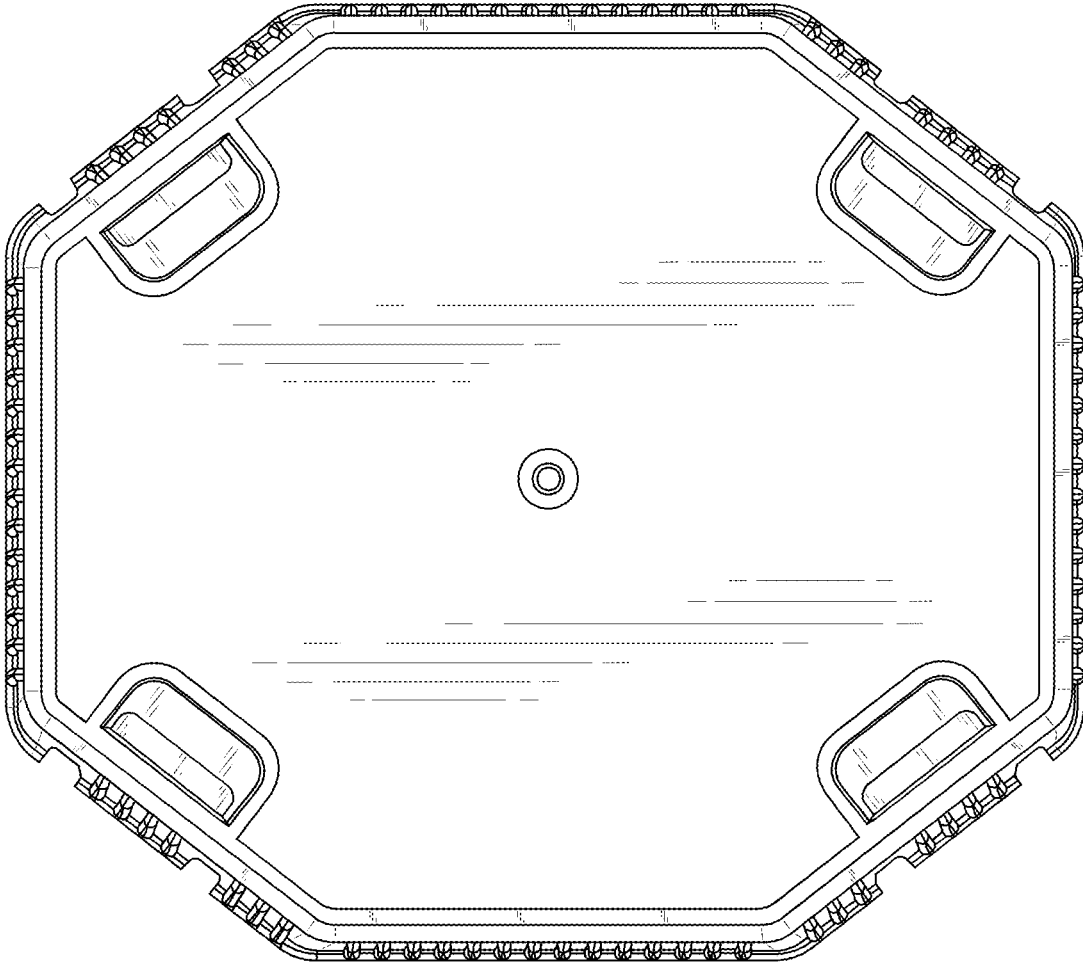

FIG. 23

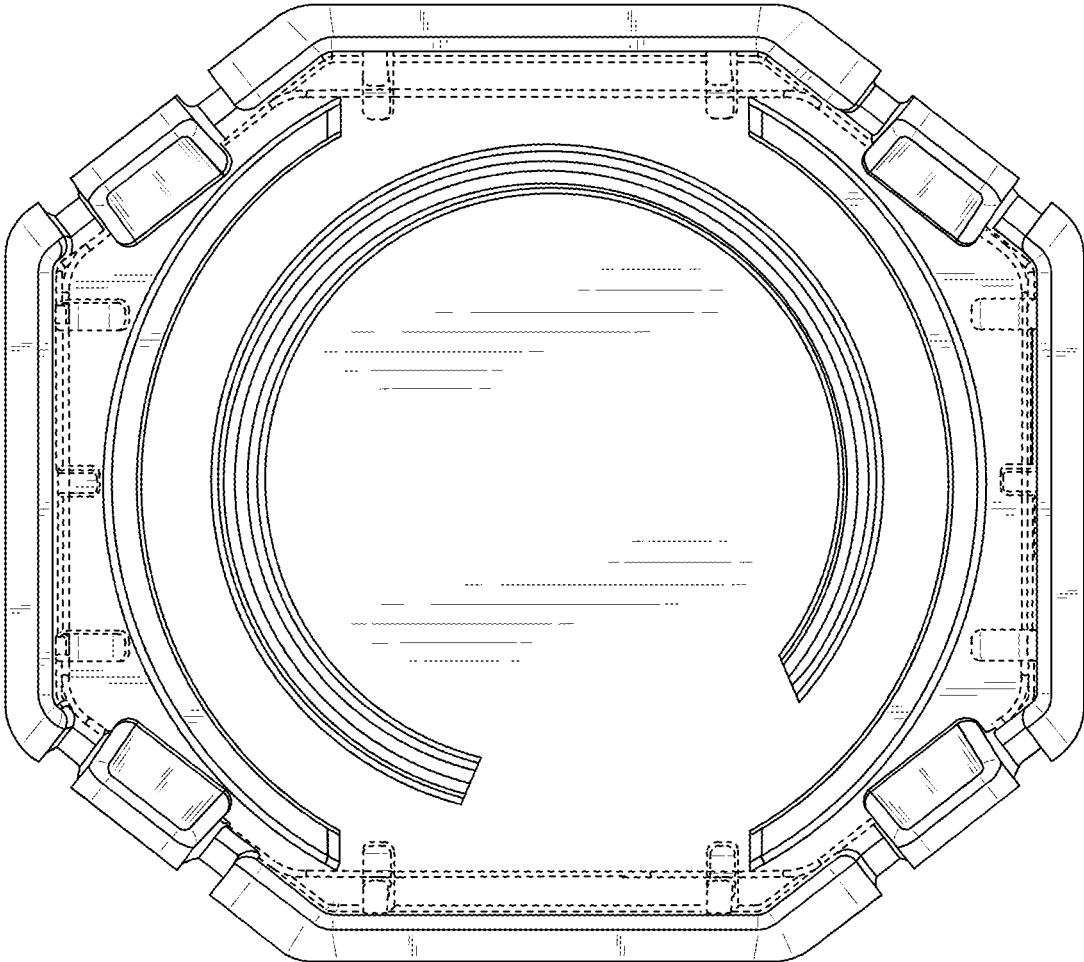

FIG. 24