



US00D727620S

(12) **United States Design Patent**
Tonelli

(10) **Patent No.:** **US D727,620 S**

(45) **Date of Patent:** **** Apr. 28, 2015**

(54) **CASE**

(71) Applicant: **G.T Line—S.R.L.**, Crespellano (IT)

(72) Inventor: **Massimo Tonelli**, Casalecchio di Reno (IT)

(73) Assignee: **G.T Line—S.R.L.** (IT)

(**) Term: **14 Years**

(21) Appl. No.: **29/440,463**

(22) Filed: **Dec. 21, 2012**

(30) **Foreign Application Priority Data**

Jun. 25, 2012 (EM) 002063230

(51) **LOC (10) Cl.** **03-01**

(52) **U.S. Cl.**

USPC **D3/276**; D3/294

(58) **Field of Classification Search**

USPC D3/272, 273, 274, 276, 279, 281, 282,
D3/294, 905, 291; D34/19; 190/18 A, 100,
190/110; 206/372, 373

See application file for complete search history.

(56) **References Cited**

U.S. PATENT DOCUMENTS

D353,048 S *	12/1994	VanSkiver et al.	D3/276
D413,202 S *	8/1999	Schmitt et al.	D3/276
D441,954 S *	5/2001	Parker	D3/279
D462,519 S *	9/2002	Gaydos et al.	D3/276
D467,424 S *	12/2002	Hardigg et al.	D3/279
D467,425 S *	12/2002	Hardigg et al.	D3/279
D467,426 S *	12/2002	Hardigg et al.	D3/279
D513,123 S *	12/2005	Richardson et al.	D3/273
D520,237 S *	5/2006	Cheng	D3/276
D523,242 S *	6/2006	Hardigg et al.	D3/276
8,297,464 B2 *	10/2012	Grenier et al.	220/326

* cited by examiner

Primary Examiner — Sheryl Lane

Assistant Examiner — Ethiene Salgado-Rodriguez

(74) *Attorney, Agent, or Firm* — Cantor Colburn LLP

(57) **CLAIM**

The ornamental design for a case, as shown and described.

DESCRIPTION

FIG. 1 is a perspective view of a case showing my new design;
FIG. 2 is a front view thereof;
FIG. 3 is a rear view thereof;
FIG. 4 is a left side view thereof;
FIG. 5 is a right side view thereof;
FIG. 6 is a top view thereof; and,
FIG. 7 is a bottom view thereof.

1 Claim, 7 Drawing Sheets

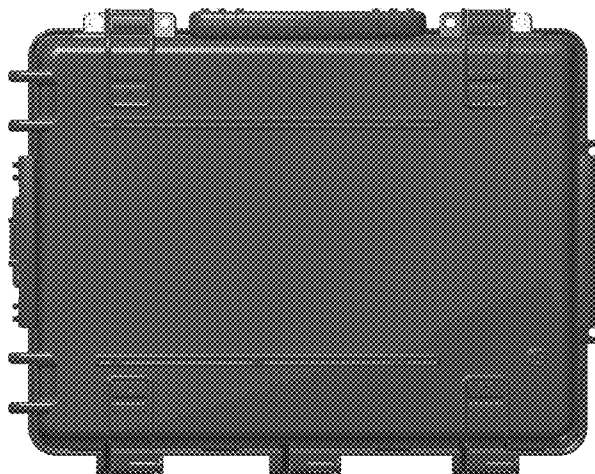
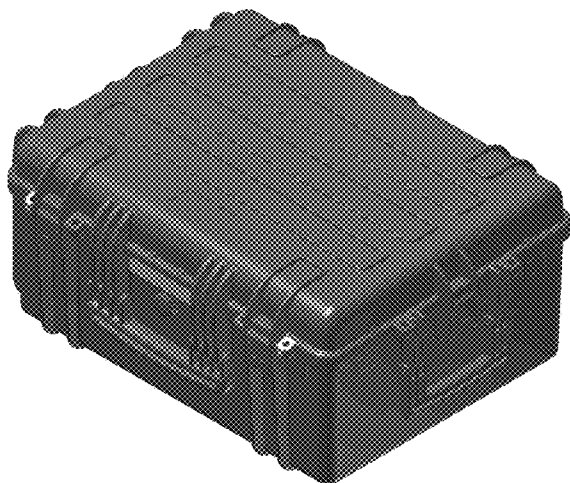



Fig. 1

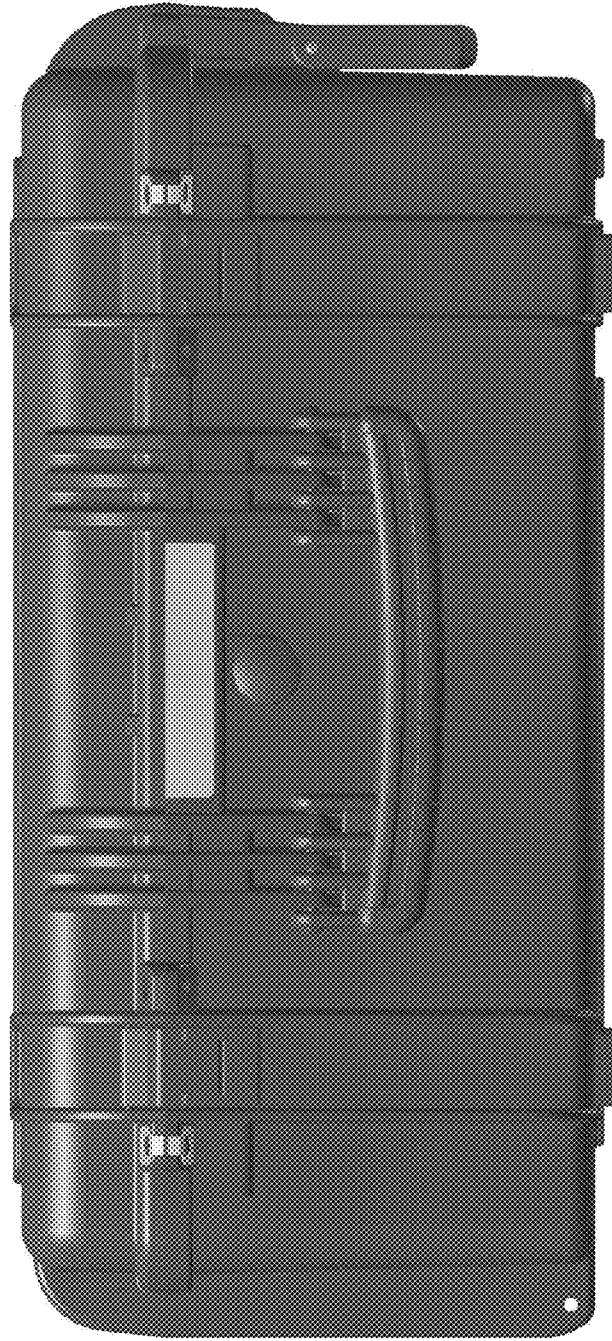

Fig. 2

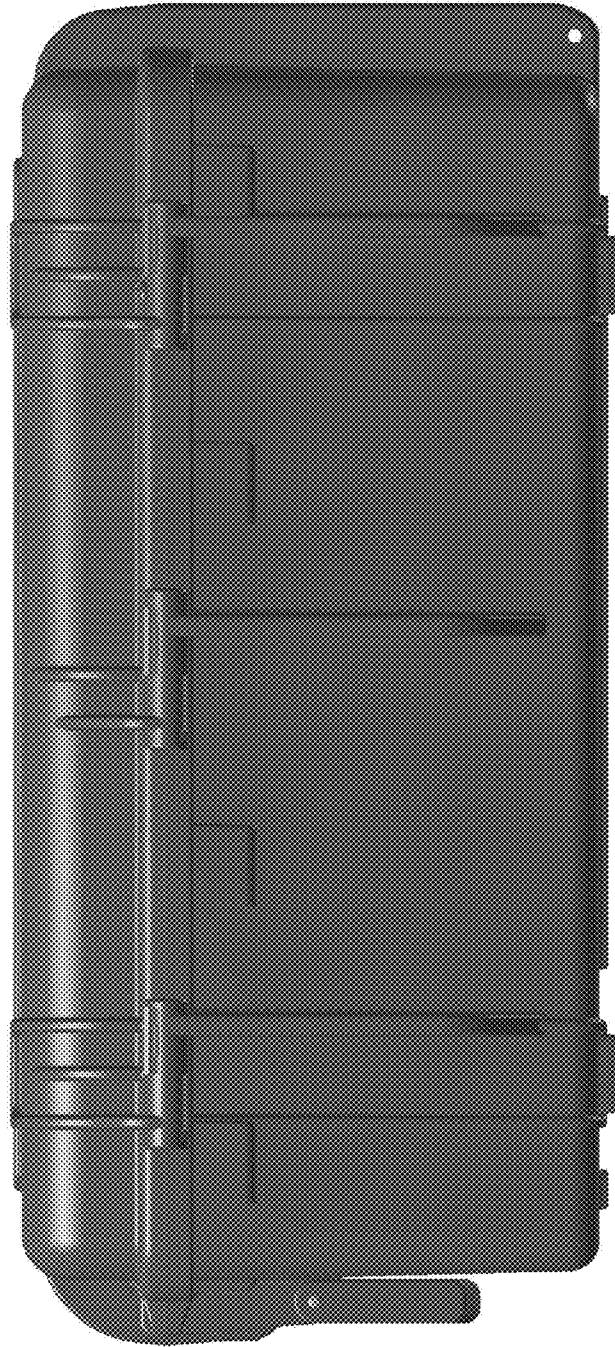

Fig. 3

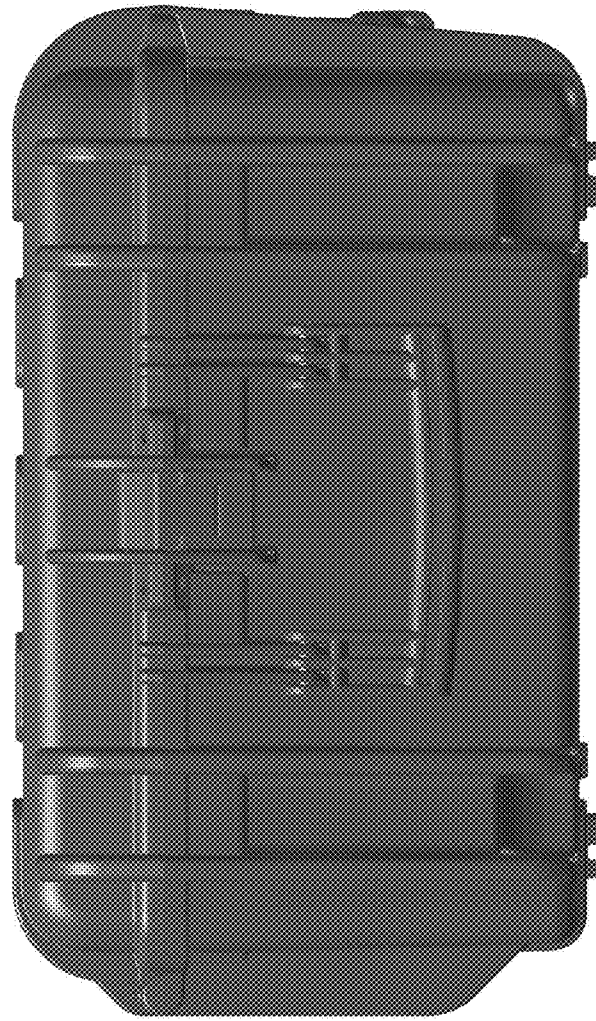

Fig. 4

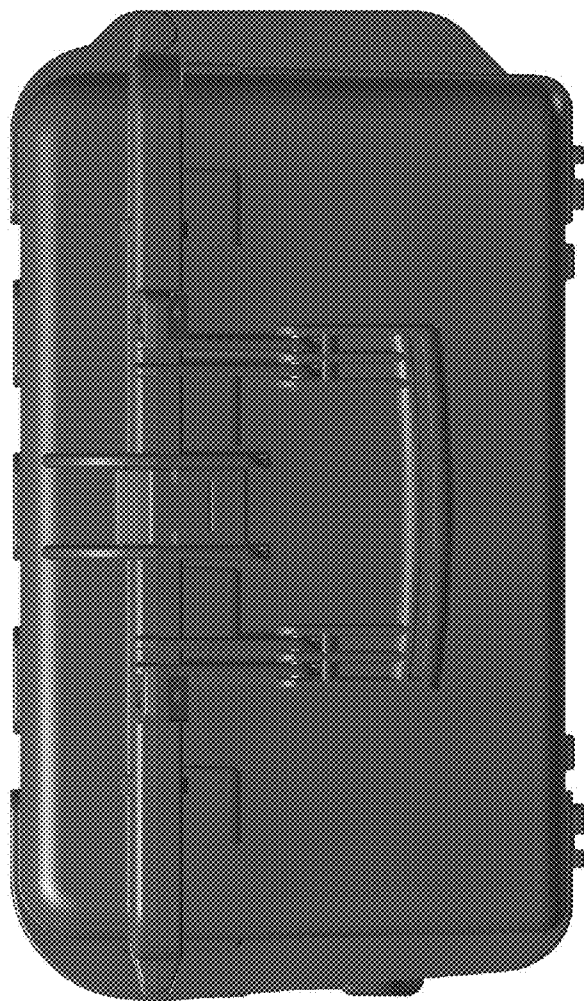

Fig. 5

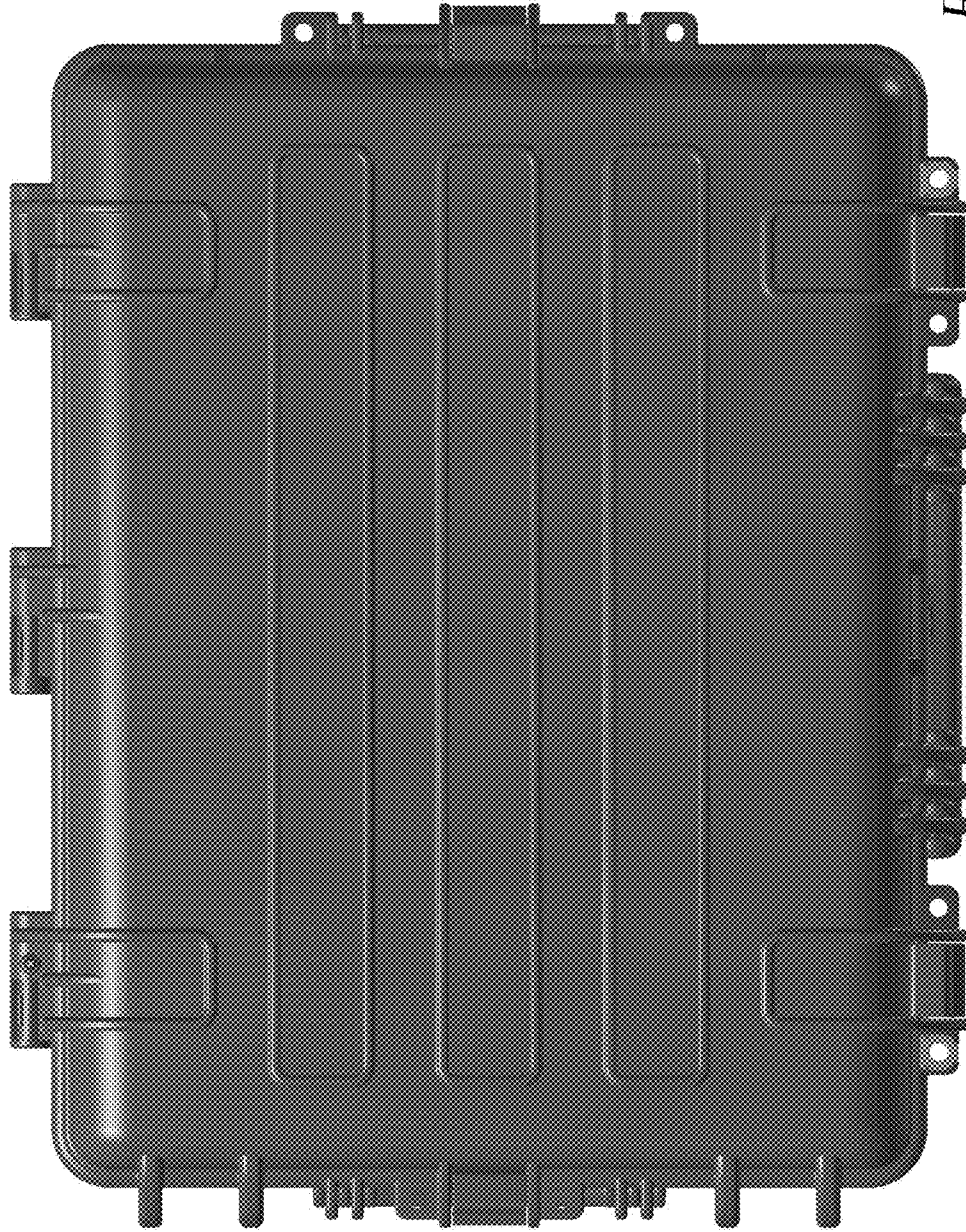

Fig. 6

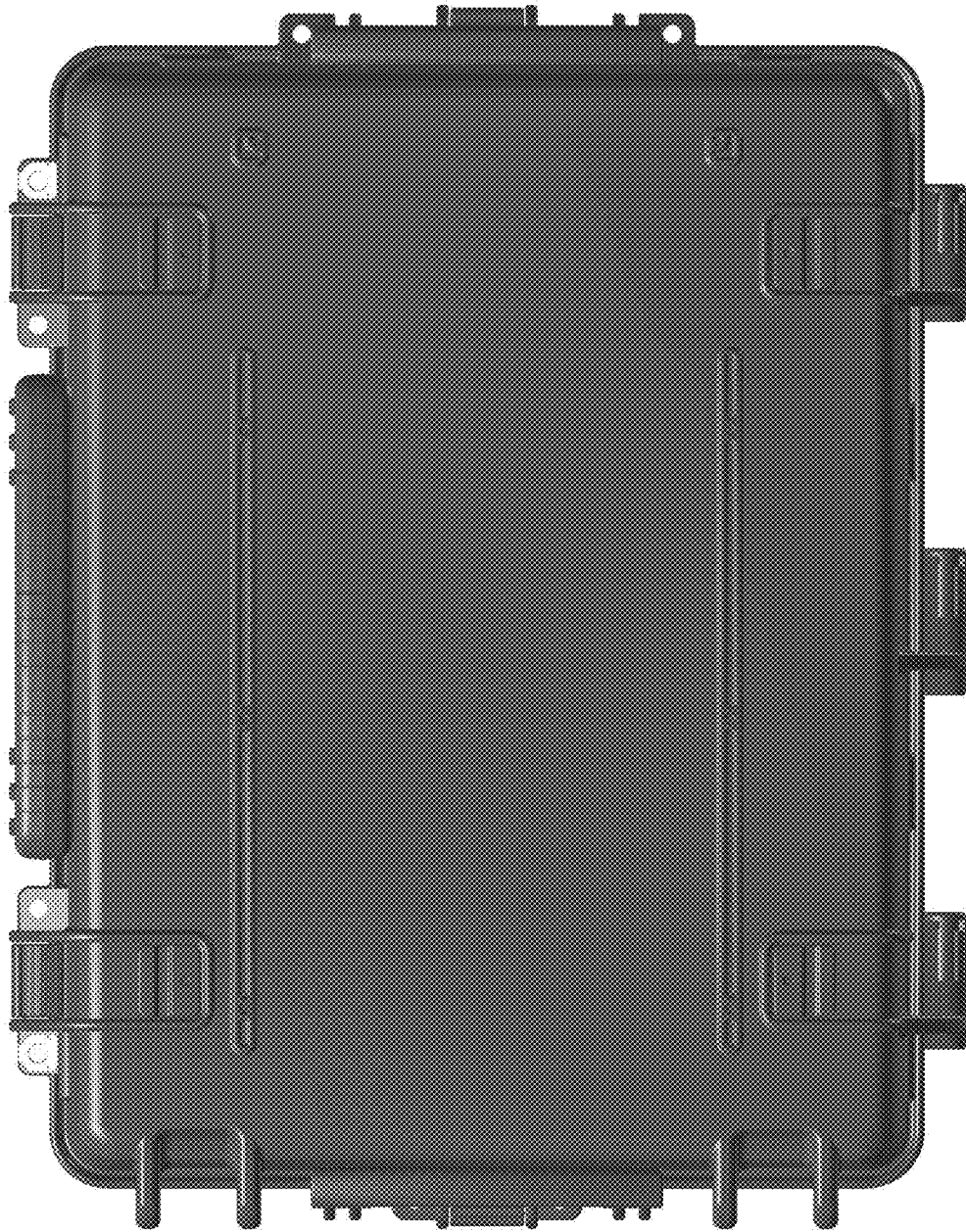

Fig. 7