



US00D871791S

(12) **United States Design Patent**
Carter

(10) **Patent No.:** **US D871,791 S**

(45) **Date of Patent:** **** Jan. 7, 2020**

(54) **RIGHT ARM OR LEFT ARM SECTIONAL**

OTHER PUBLICATIONS

(71) Applicant: **Blu Dot Design & Manufacturing, Inc.**, Minneapolis, MN (US)

Blu Dot Catalog No. 16, Designed in Minneapolis, Minnesota, Copyright 2015, 44 pages.

(Continued)

(72) Inventor: **Michael Carter**, Bloomington, MN (US)

Primary Examiner — Mimosa De

(74) *Attorney, Agent, or Firm* — Fredrikson & Byron P.A.

(73) Assignee: **Blu Dot Design & Manufacturing, Inc.**, Minneapolis, MN (US)

(**) Term: **15 Years**

(57) **CLAIM**

(21) Appl. No.: **29/629,145**

I claim the ornamental design for a right arm or left arm sectional, as shown and described.

(22) Filed: **Dec. 12, 2017**

(51) **LOC (12) Cl.** **06-01**

(52) **U.S. Cl.**

USPC **D6/377**

(58) **Field of Classification Search**

USPC D6/334–336, 364, 371, 373, 374, 375,

D6/377, 381, 716, 716.1, 716.2, 716.4

CPC A47C 1/00; A47C 11/00; A47C 15/002;

A47C 7/18; A47C 7/24; A47C 7/50;

A47C 7/54

See application file for complete search history.

DESCRIPTION

FIG. 1 is a front perspective view of a right arm or left arm sectional of Applicant's design;

FIG. 2 is a front elevational view thereof;

FIG. 3 is a rear elevational view thereof;

FIG. 4 is a first side elevational view thereof;

FIG. 5 is a second side elevational view thereof, the second side being opposite the first side;

FIG. 6 is a top plan view thereof; and

FIG. 7 is a bottom plan view thereof.

FIG. 8 is a front perspective view of a second embodiment of a right arm or left arm sectional of Applicant's design, the second embodiment being a mirror image of the first embodiment;

FIG. 9 is a front elevational view thereof;

FIG. 10 is a rear elevational view thereof;

FIG. 11 is a first side elevational view thereof;

FIG. 12 is a second side elevational view thereof, the second side being opposite the first side;

FIG. 13 is a top plan view thereof; and,

FIG. 14 is a bottom plan view thereof.

Where included, broken lines showing environment or structure are for illustrative purposes only and form no part of the claimed design.

(56) **References Cited**

U.S. PATENT DOCUMENTS

D174,828 S * 5/1955 Michlin D6/377

D176,938 S * 2/1956 Wilson D6/377

3,695,690 A 10/1972 Carson

D234,731 S 4/1975 McDonald

D239,580 S 4/1976 Robertson et al.

D241,590 S 9/1976 Kaplan

D255,513 S 6/1980 Collins

D268,970 S 5/1983 Mascheroni

D269,482 S 6/1983 Ungaro

D270,308 S 8/1983 Aronowitz et al.

D360,310 S 7/1995 Stamberg et al.

D382,124 S 8/1997 Chandler

D399,661 S 10/1998 Smith

D404,930 S 2/1999 Gibson

(Continued)

1 Claim, 12 Drawing Sheets

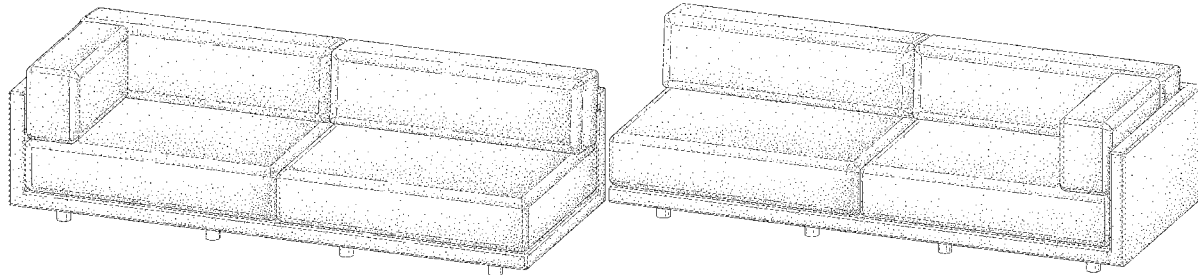

(56)

References Cited

U.S. PATENT DOCUMENTS

D431,381 S 10/2000 Gomez
 D432,808 S 10/2000 Binder et al.
 D446,039 S 8/2001 Gomez
 D448,196 S 9/2001 Gomez
 D448,946 S 10/2001 Goetz
 D460,284 S 7/2002 Natuzzi et al.
 D484,712 S 1/2004 Gomez
 D484,713 S 1/2004 Gomez
 D498,064 S 11/2004 Gomez
 D498,941 S * 11/2004 Ricci D6/335
 D559,003 S 1/2008 Lissoni
 D561,496 S 2/2008 Kreiss
 D562,022 S 2/2008 Hackethal et al.
 D566,417 S 4/2008 Mourgue
 D576,818 S 9/2008 Kreiss
 D584,900 S 1/2009 Hackethal et al.
 D585,200 S 1/2009 Lissoni
 D586,146 S 2/2009 Mourgue
 D586,578 S 2/2009 Mourgue
 D587,028 S 2/2009 Mourgue
 D587,029 S 2/2009 Mourgue
 D588,827 S 3/2009 Mourgue
 D590,166 S 4/2009 Natuzzi
 D591,071 S 4/2009 Weiss
 D614,876 S 5/2010 Metcalf et al.
 D618,935 S 7/2010 Metcalf et al.
 D647,317 S * 10/2011 Urquiola D6/377
 D655,935 S 3/2012 Semp
 D666,424 S 9/2012 Carter, III
 D685,202 S * 7/2013 Sage D6/377
 D688,475 S 8/2013 Blet et al.
 D698,173 S 1/2014 Caldwell
 D698,177 S 1/2014 Nguyen et al.
 D698,178 S 1/2014 Nguyen et al.
 D698,179 S 1/2014 Nguyen et al.
 D699,456 S 2/2014 Bosman
 D720,142 S 12/2014 Nigro

D725,921 S 4/2015 Banda
 D736,535 S 8/2015 Foersom et al.
 D749,862 S 2/2016 Polk-Kuku
 D763,000 S 8/2016 King et al.
 D763,590 S 8/2016 King et al.
 D763,591 S 8/2016 King et al.
 D763,592 S 8/2016 King et al.
 D781,610 S 3/2017 King et al.
 D800,460 S 10/2017 Rockwell et al.
 D802,323 S 11/2017 Binfare
 D807,655 S 1/2018 Webb
 D807,660 S 1/2018 Hughes
 D815,443 S 4/2018 Bozzoli
 D815,851 S 4/2018 Rafieha
 D834,849 S 12/2018 Binfare'
 D842,617 S 3/2019 Carter
 D843,749 S 3/2019 Aubry
 D849,438 S 5/2019 Williams, Jr. et al.
 D849,439 S 5/2019 Williams, Jr. et al.
 D850,141 S 6/2019 King et al.
 D850,142 S 6/2019 King et al.
 2011/0010847 A1 1/2011 Murphy

OTHER PUBLICATIONS

Blu Dot Catalog No. 17, Designed in Minneapolis, Minnesota, Copyright 2015, 52 pages.
 Blu Dot Catalog No. 18, Designed in Minneapolis, Minnesota, Copyright 2015, 51 pages.
 Blu Dot Catalog No. 19, Designed in Minneapolis, Minnesota, Copyright 2016, 54 pages.
 Sunday Small Ottoman—Small Upholstered Ottoman_ Blu Dot. [online] Retrieved Aug. 1, 2018 from URL: <https://www.bludot.com/sunday-small-ottoman.html>.
 Kipton Ottoman. Arhaus Furniture. [online] Retrieved Aug. 1, 2018 from URL: <https://www.arhaus.com/furniture/living-room-furniture/all-living-room-furniture/kipton-ottoman/?Fabric+Name=PLUSH%20LINEN&Width=41%22&>.

* cited by examiner

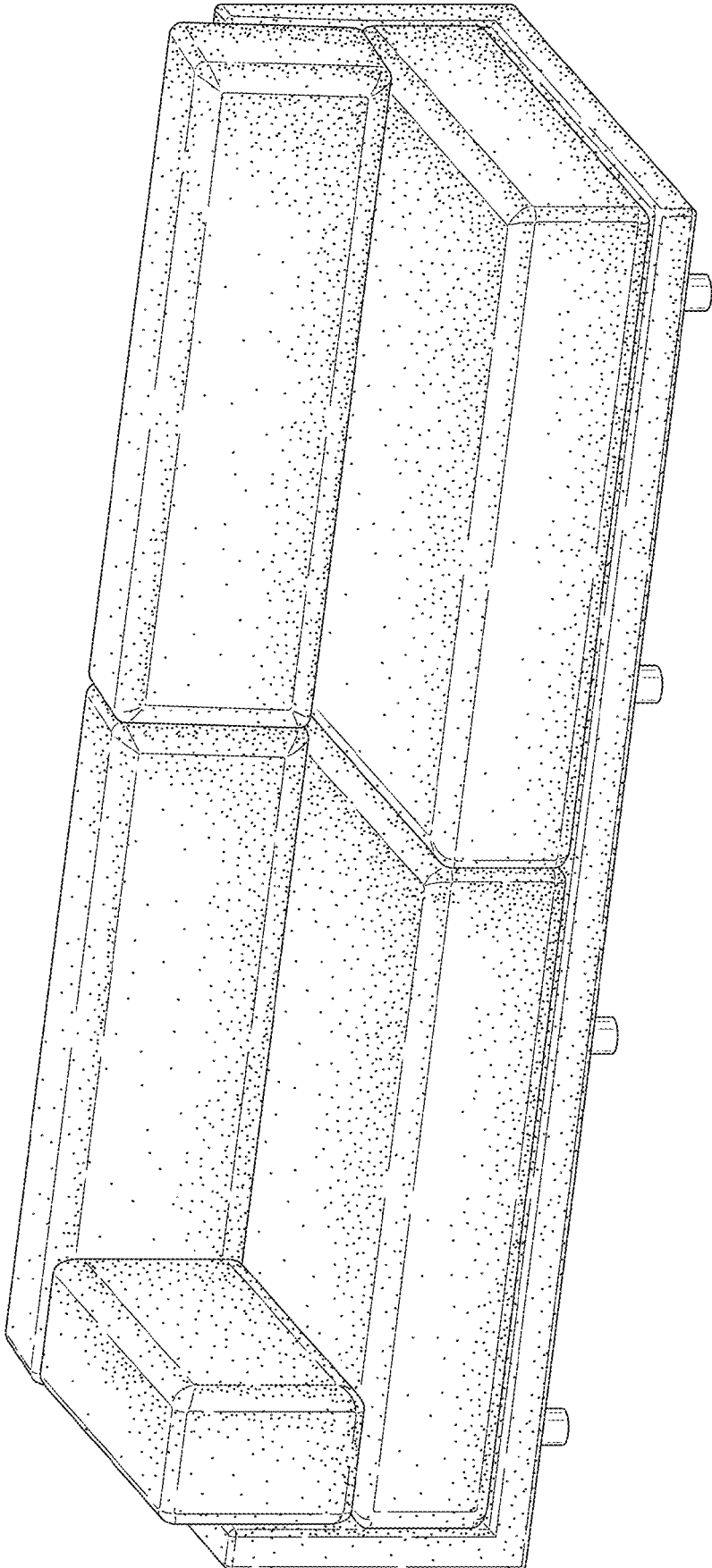

FIG. 1

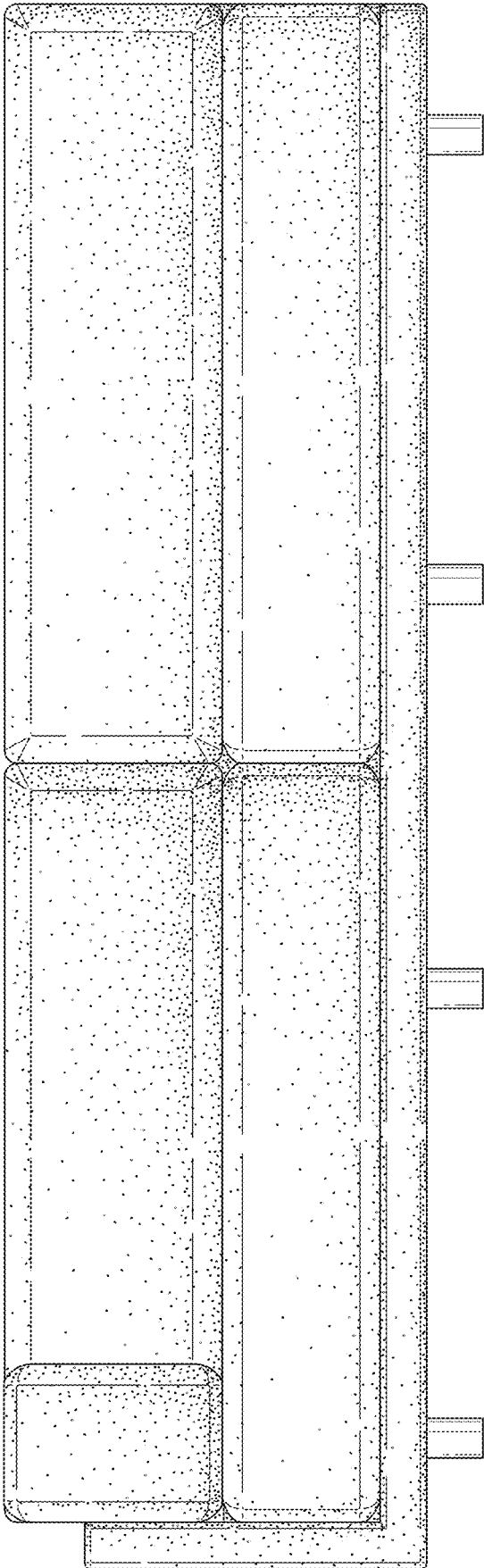

FIG. 2

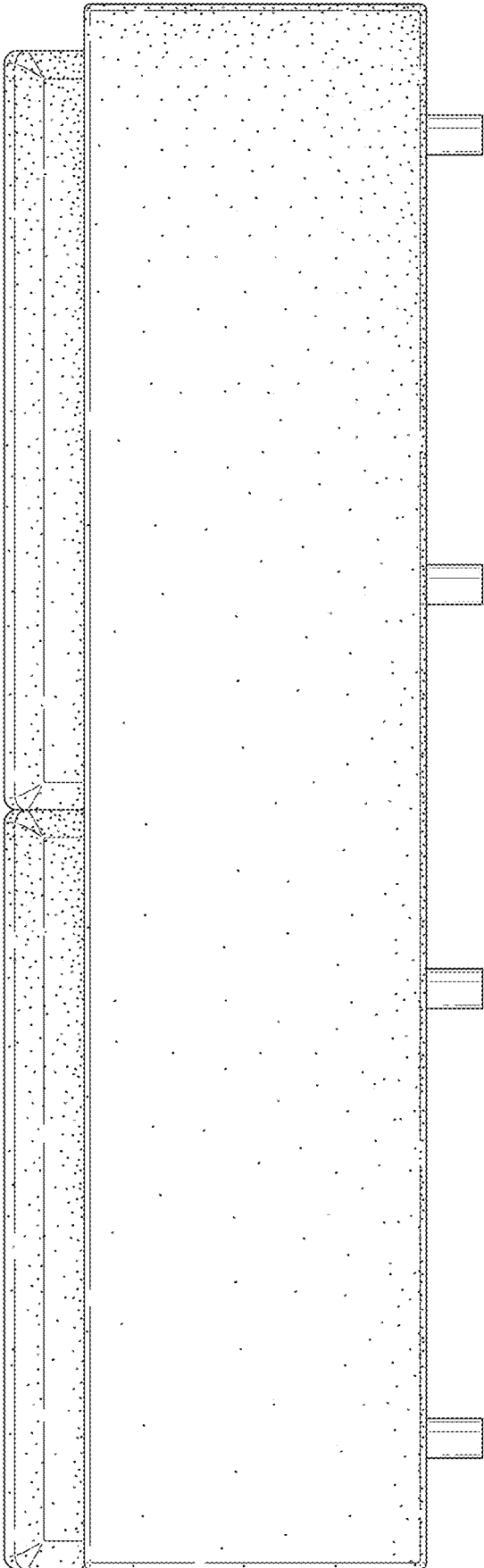

FIG. 3

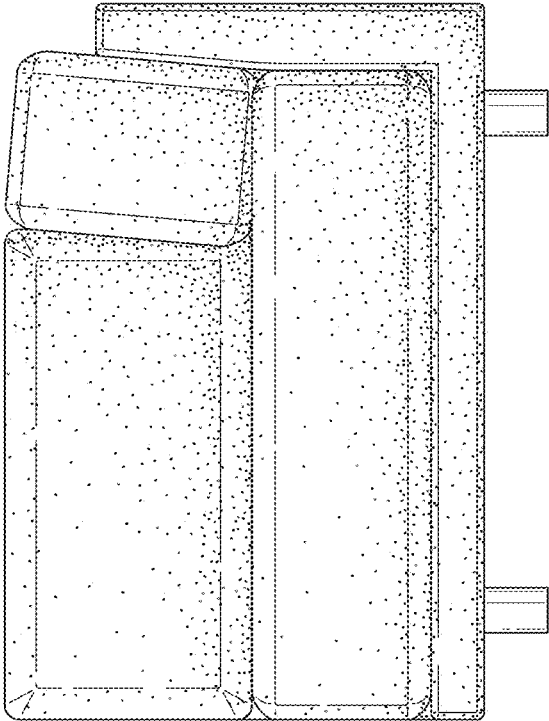

FIG. 5

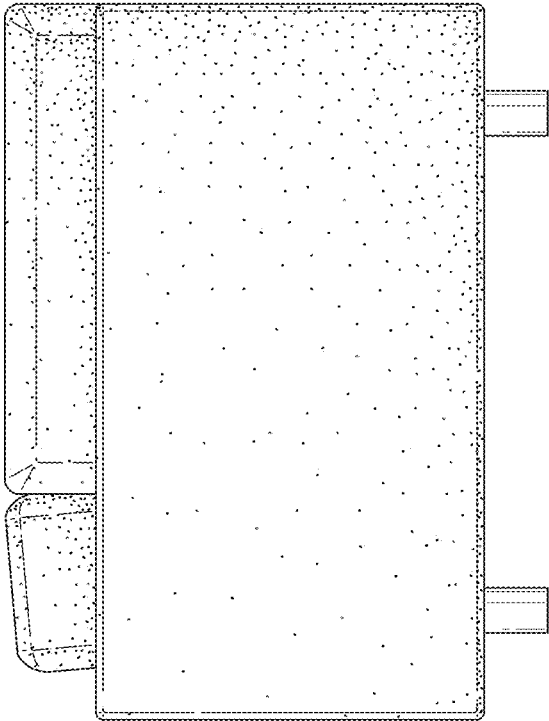

FIG. 4

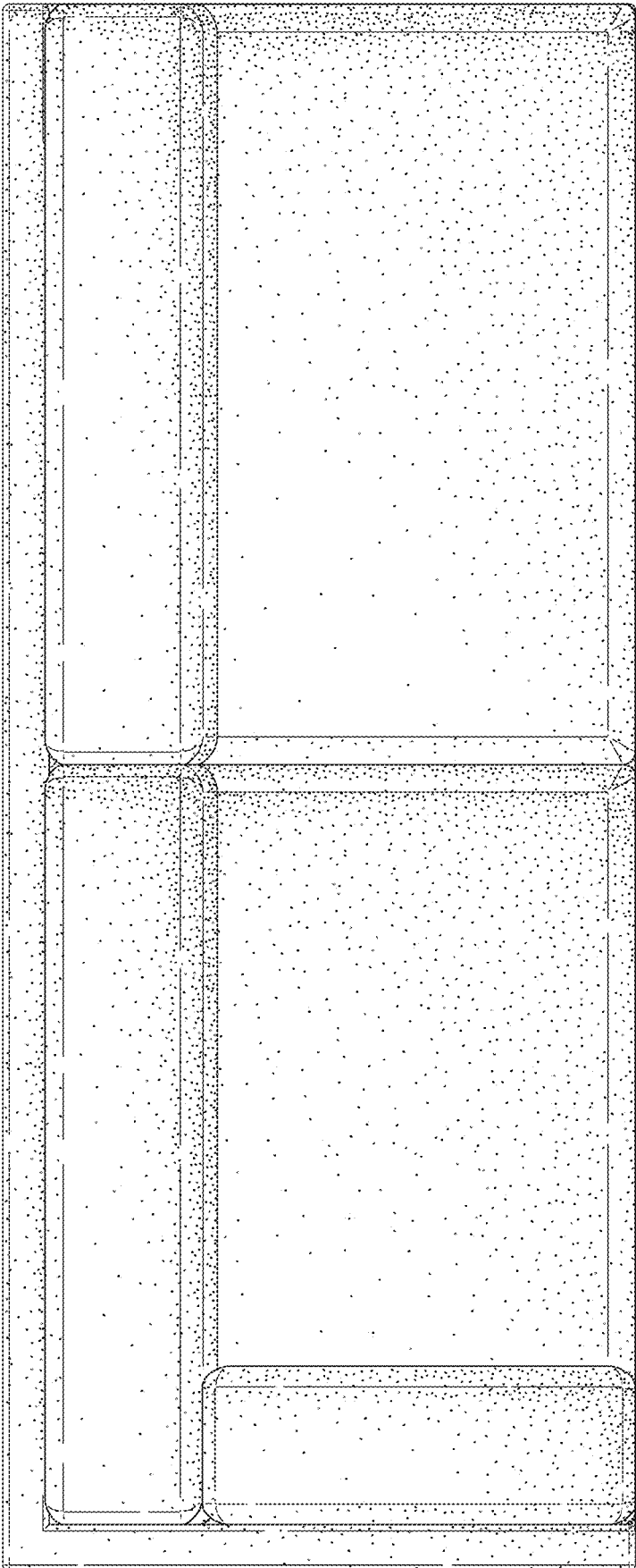

FIG. 6

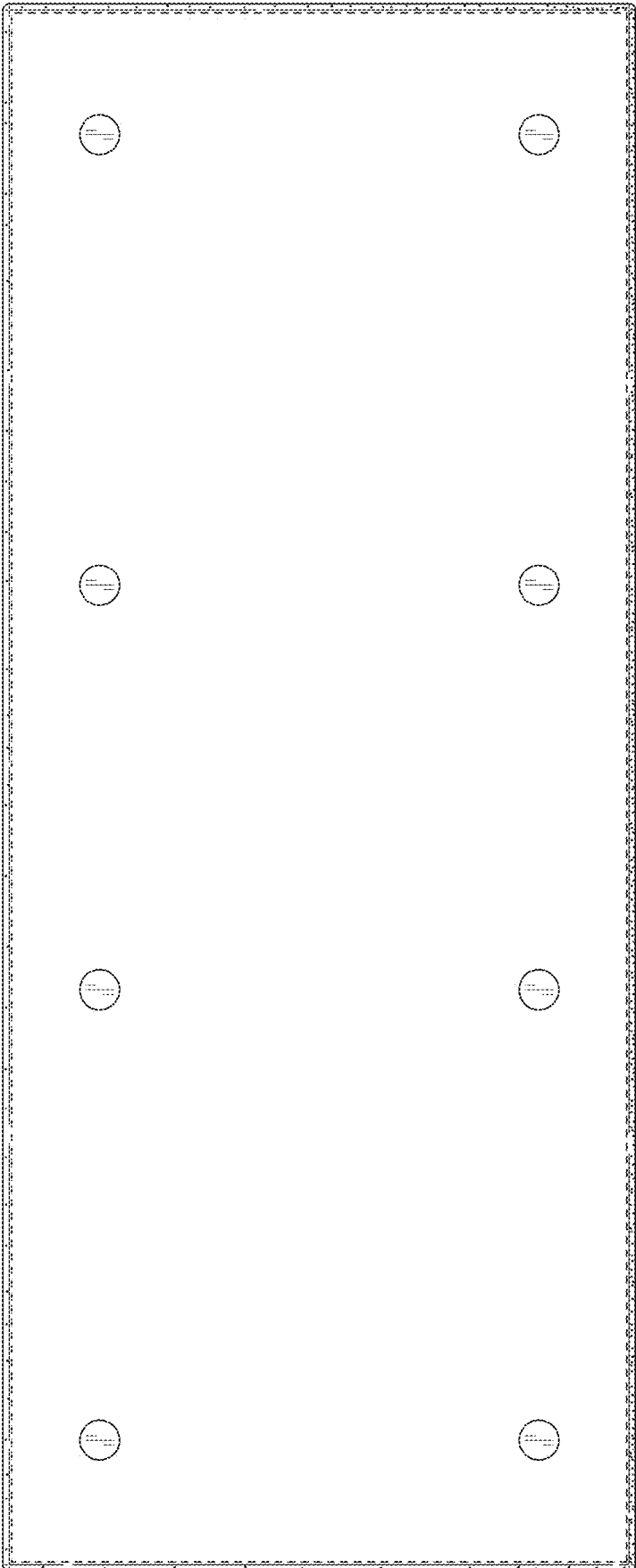

FIG. 7

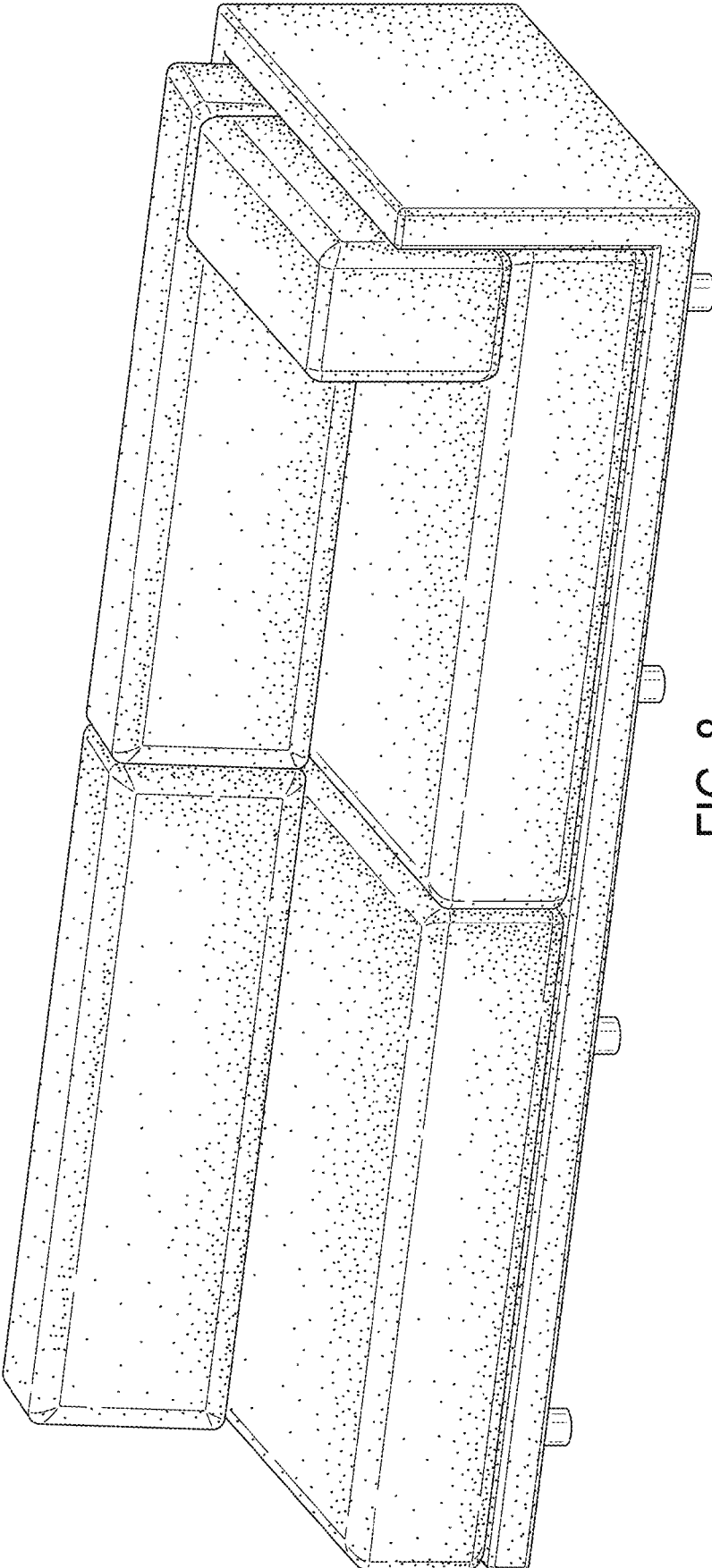

FIG. 8

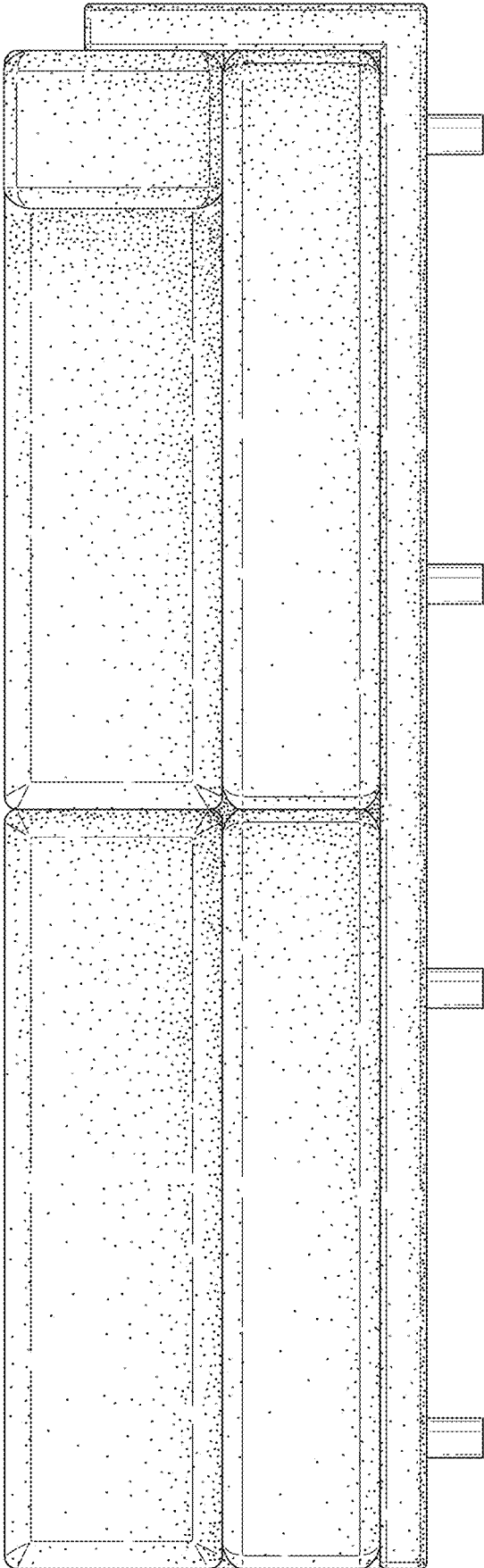

FIG. 9

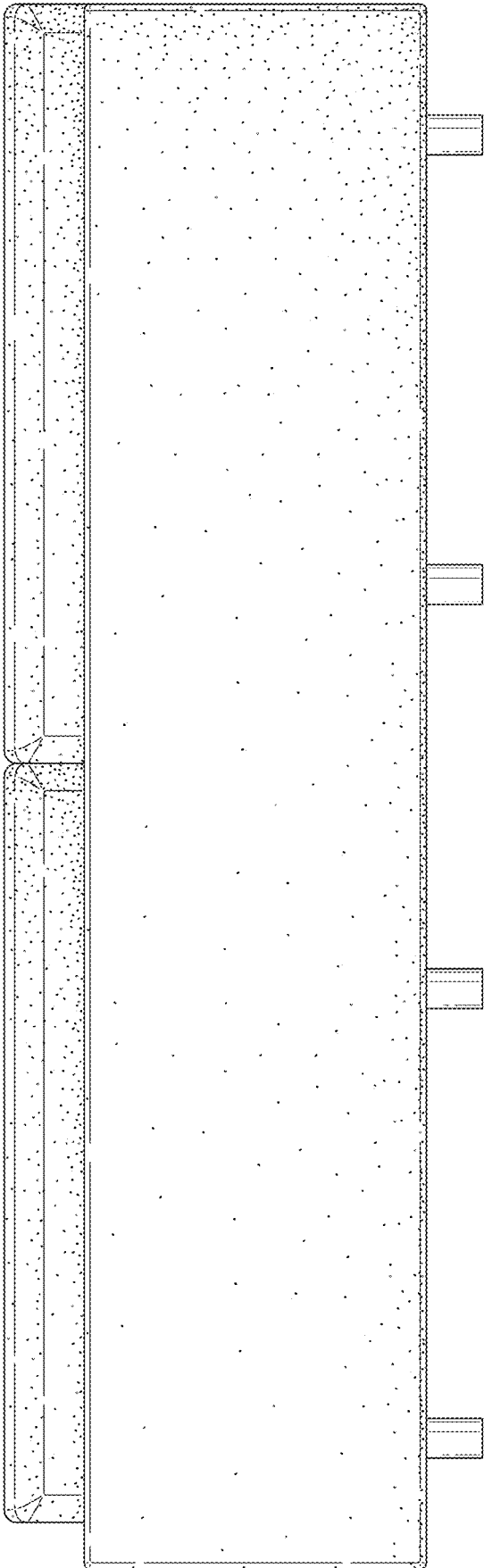

FIG. 10

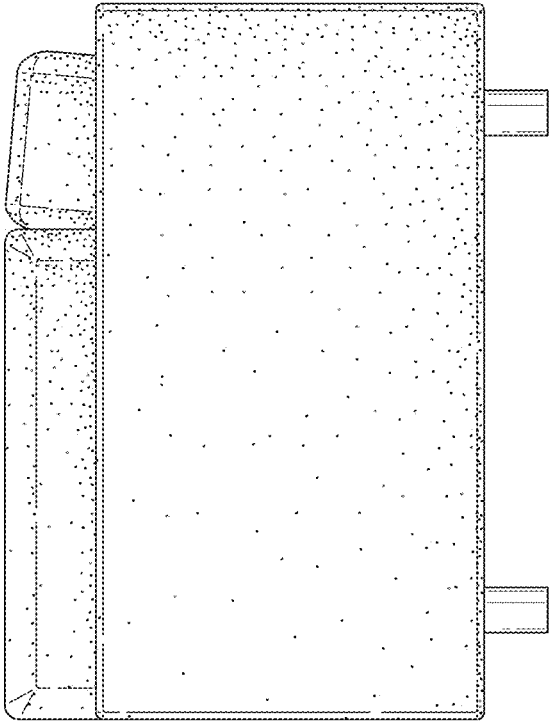

FIG. 12

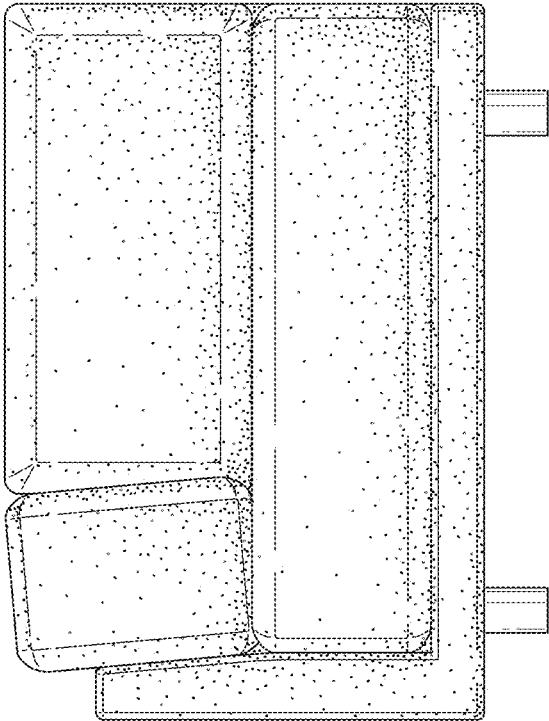

FIG. 11

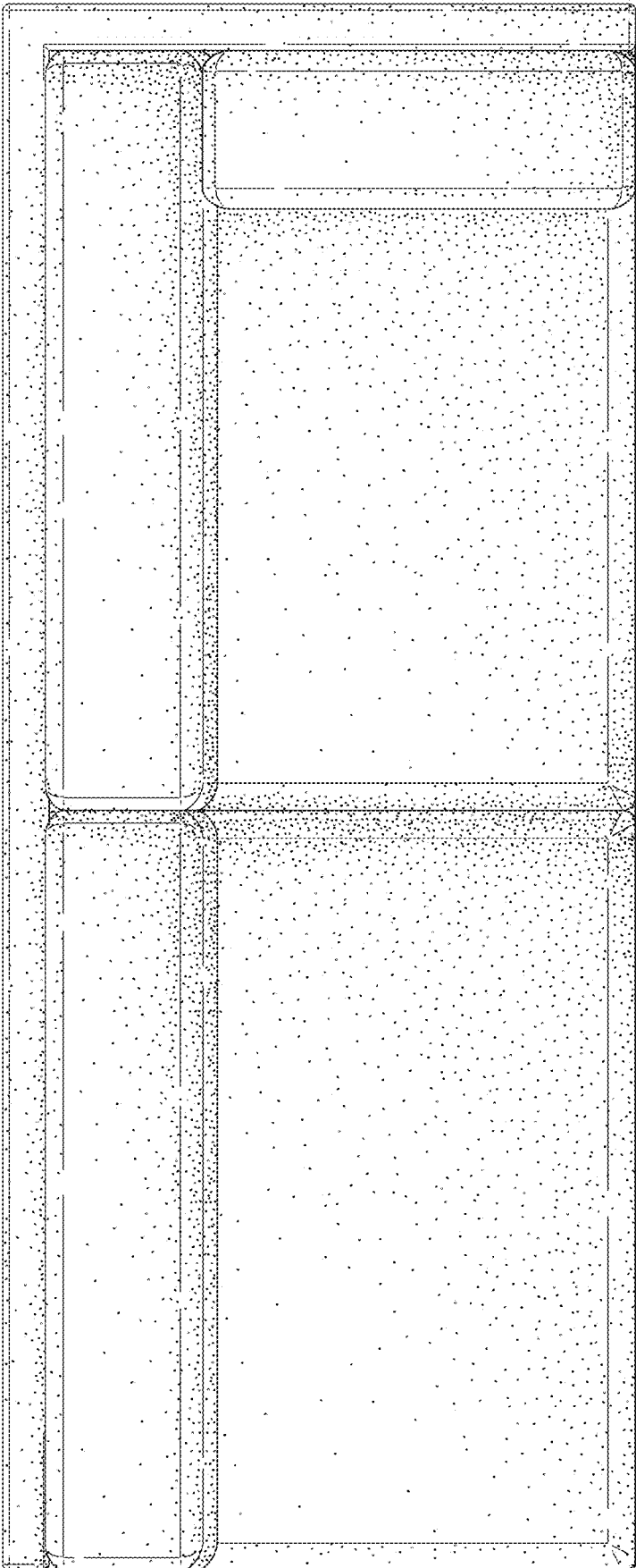

FIG. 13

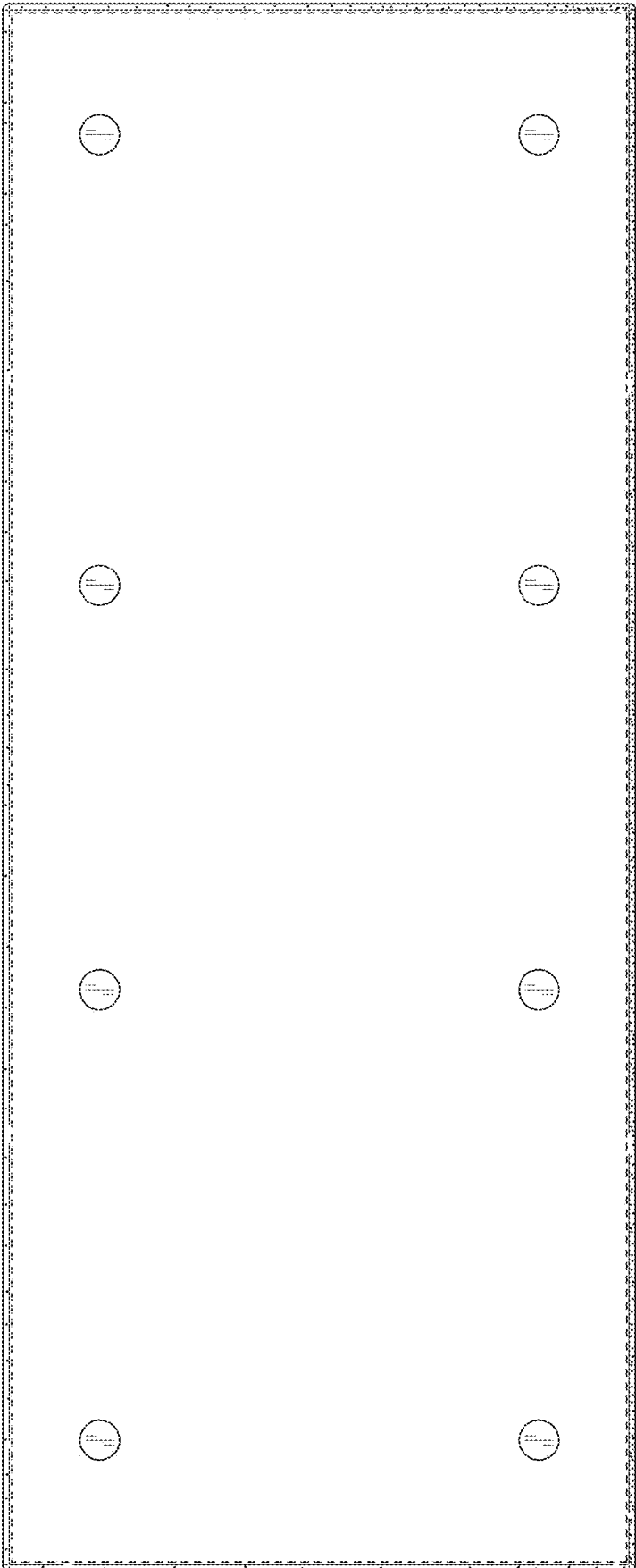

FIG. 14