

[54] **SKATEBOARD**

[76] **Inventor:** Leonard A. Morris, Sr., 138  
Panorama Dr., Benicia, Calif. 94510

[\*\*] **Term:** 14 Years

[21] **Appl. No.:** 115,740

[22] **Filed:** Jan. 28, 1980

[51] **Int. Cl.** ..... D21-02

[52] **U.S. Cl.** ..... D21/227

[58] **Field of Search** ..... D21/224-228;  
280/87.04 R, 87.04 A, 87.01, 11.19

[56] **References Cited**

**U.S. PATENT DOCUMENTS**

D. 222,158 10/1971 Noches ..... D21/228

**OTHER PUBLICATIONS**

Playthings, 10-1977, p. 39, Skateboard at #500.  
Skateboarder, 8-1978, p. 155, Item #10, Skateboard.

*Primary Examiner*—Charles A. Rademaker

[57] **CLAIM**

The ornamental design for a skateboard, as shown.

**DESCRIPTION**

The FIG. 1 is a perspective view of a skateboard, showing my new design;

The FIG. 2 is a top plan view thereof;

The FIG. 3 is a front elevational view thereof;

The FIG. 4 is a right elevational view thereof;

The FIG. 5 is a rear elevational view thereof; and

The FIG. 6 is a bottom plan view thereof.

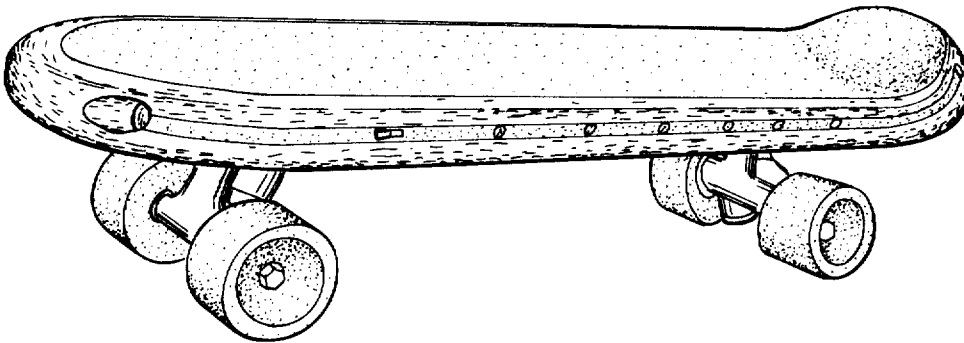

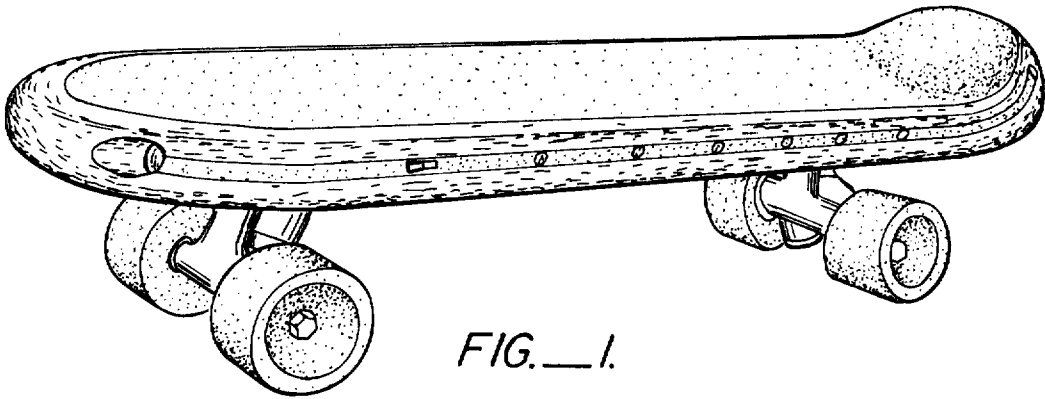

FIG. 1.

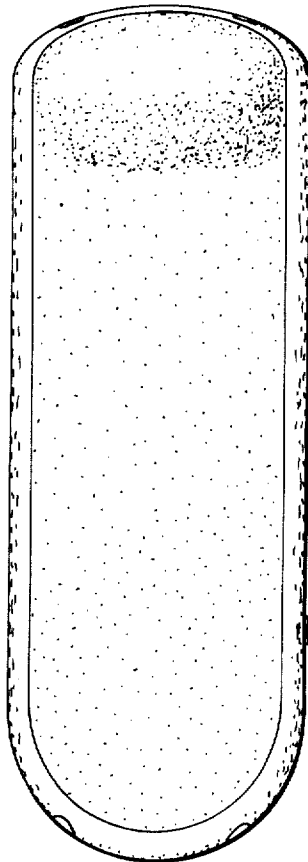

FIG. 2.

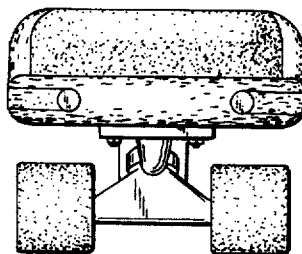

FIG. 3.

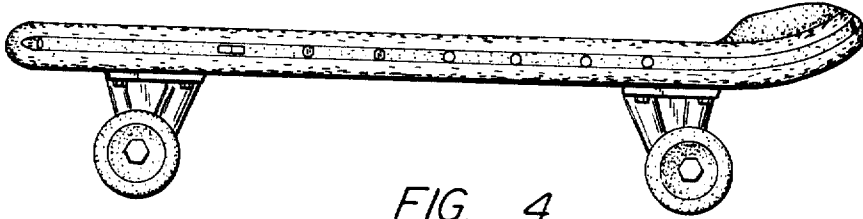

FIG. 4.

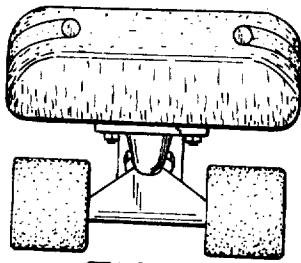

FIG. 5.

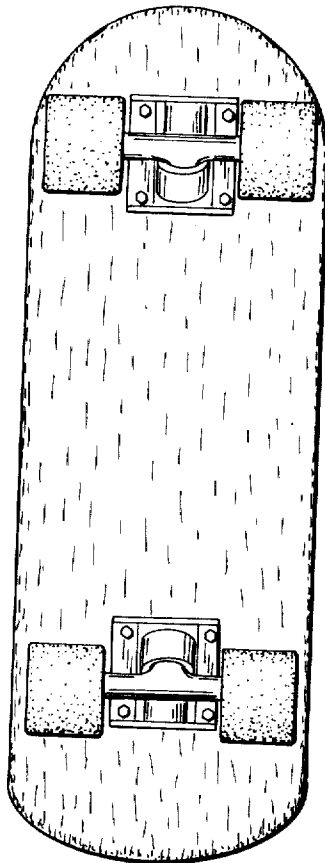

FIG. 6.