



US0D1049636S

(12) **United States Design Patent**
Gu

(10) **Patent No.:** **US D1,049,636 S**

(45) **Date of Patent:** **** Nov. 5, 2024**

(54) **WEARABLE CLEANING CADDY BAG**

(71) Applicant: **Wanshui Gu**, Jiangsu (CN)

(72) Inventor: **Wanshui Gu**, Jiangsu (CN)

(**) Term: **15 Years**

(21) Appl. No.: **29/941,065**

(22) Filed: **May 7, 2024**

(51) **LOC (14) Cl.** **03-01**

(52) **U.S. Cl.**

USPC **D3/315**

(58) **Field of Classification Search**

USPC D3/232, 244, 245, 246, 315, 318, 201,
D3/276, 283, 287, 289, 235, 303, 304,
D3/904, 308; D2/864

(Continued)

(56) **References Cited**

U.S. PATENT DOCUMENTS

D468,533 S 1/2003 MacRae
D555,906 S * 11/2007 Hecht D3/318

(Continued)

FOREIGN PATENT DOCUMENTS

GB 6154436 * 8/2021

OTHER PUBLICATIONS

Amazon.ca, Site visited Aug. 27, 2024, Ziozert Multipurpose
Cleaning Caddy Bag, Date first available, Sep. 5, 2022, [https://
www.amazon.ca/dp/B0BB9TM36P](https://www.amazon.ca/dp/B0BB9TM36P) (Year: 2022).*

(Continued)

Primary Examiner — Brett Miller
Assistant Examiner — Jessica M Gebhart

(74) *Attorney, Agent, or Firm* — Hawaii Patent Services;
Nathaniel K. Fedde; Kenton N. Fedde

(57) **CLAIM**

The ornamental design for a wearable cleaning caddy bag,
as shown and described.

DESCRIPTION

FIG. 1 is a front, right, top perspective view of a wearable
cleaning caddy bag, showing my new design;

FIG. 2 is a rear, left, bottom perspective view thereof;

FIG. 3 is a front, right, top perspective view of its enlarged
scale in another angle;

FIG. 4 is a front elevational view of the enlarged scale
thereof;

FIG. 5 is a rear elevational view of the enlarged scale
thereof;

FIG. 6 is a left side view of the enlarged scale thereof;

FIG. 7 is a right side view of the enlarged scale thereof;

FIG. 8 is a top plan view of the enlarged scale thereof;

FIG. 9 is a bottom side view of the enlarged scale thereof;

FIG. 10 is an enlarged view of detail 10 in FIG. 1;

FIG. 11 is an enlarged view of detail 11 in FIG. 1;

FIG. 12 is an enlarged view of detail 12 in FIG. 2;

FIG. 13 is an enlarged view of detail 13 in FIG. 2;

FIG. 14 is an enlarged view of detail 14 in FIG. 3;

FIG. 15 is an enlarged view of detail 15 in FIG. 3;

FIG. 16 is an enlarged view of detail 16 in FIG. 3;

FIG. 17 is an enlarged view of detail 17 in FIG. 3;

FIG. 18 is an enlarged view of detail 18 in FIG. 4;

FIG. 19 is an enlarged view of detail 19 in FIG. 6;

FIG. 20 is an enlarged view of detail 20 in FIG. 6; and,

FIG. 21 is an enlarged view of detail 21 in FIG. 8.

The dashed broken lines in the figures are for the purposes
of illustrating portions of the wearable cleaning caddy bag
and form no part of the claimed design.

The short-short-long dashed broken lines immediately adja-
cent to the claimed areas in the views represent the bound-
aries of the design and form no part of the claimed design.
The dash-dot-dash broken lines are for notating enlarged
views and form no part of the claimed design.

1 Claim, 18 Drawing Sheets

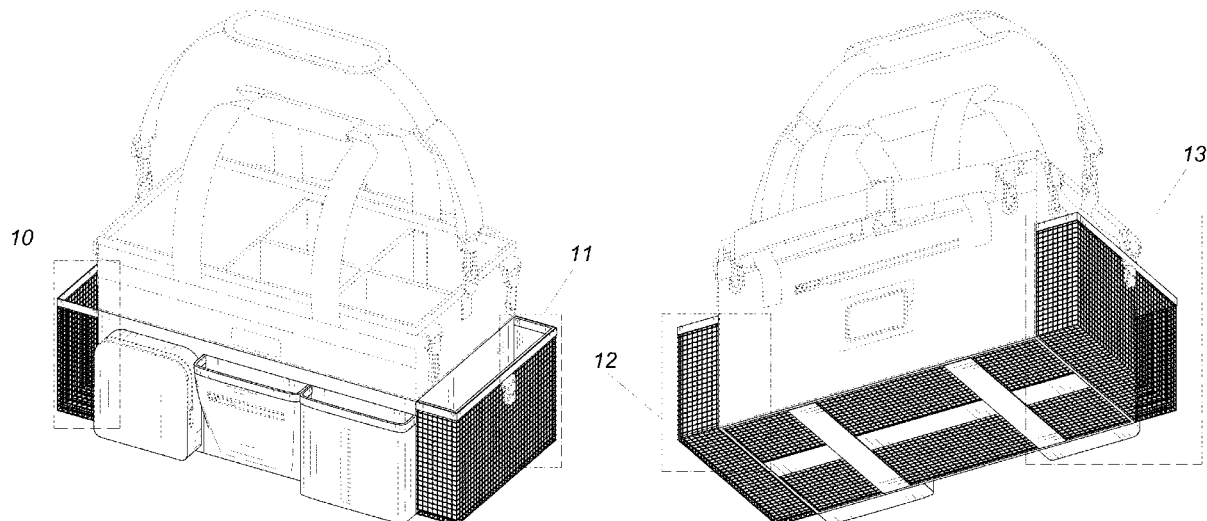

(58) **Field of Classification Search**

CPC ... F16G 11/00; A45C 3/00; A45C 3/06; A45C 3/04; A45C 7/0063; A45C 13/02; A45C 13/00; A45C 3/10; A45C 7/0077; B65D 25/282

See application file for complete search history.

D1,010,984 S * 1/2024 Dodson D3/315
 D1,018,022 S * 3/2024 Dodson D3/315
 D1,019,142 S * 3/2024 Dodson D3/315
 2008/0179370 A1 * 7/2008 Williams A45C 13/02
 224/191

(56)

References Cited

U.S. PATENT DOCUMENTS

D647,301 S * 10/2011 Sosnovsky D3/289
 D648,533 S * 11/2011 Sosnovsky D3/289
 D762,978 S 8/2016 Boroski
 D766,571 S 9/2016 Boroski
 D827,299 S * 9/2018 Vickery D3/246
 D871,764 S * 1/2020 Woolery D3/308
 D893,183 S 8/2020 Eisenhardt
 D896,514 S 9/2020 Tan
 D919,297 S * 5/2021 Wang D3/315
 D939,209 S 12/2021 Tan
 D941,635 S 1/2022 Mukri
 D950,245 S * 5/2022 Dodson D3/315
 D972,844 S * 12/2022 Chi D3/315
 D979,244 S 2/2023 Luo

OTHER PUBLICATIONS

Amazon.com, Site visited Aug. 27, 2024, Storage Standard Cleaning Caddy Organizer, Date first available, Jan. 22, 2023, <https://www.amazon.com/Cleaning-Caddy-Organizer-Handle-Housekeeping/dp/B0BJPF5SMH> (Year: 2023).
 Amazon.com, Site visited Aug. 27, 2024, Noelen Gad Wearable Cleaning Caddy Bag, Date first available, Apr. 10, 2023, <https://www.amazon.com/dp/B0C1YLZ3YJ> (Year: 2023).
 “Jkao Large Wearable Cleaning Caddy Bags, Cleaning Supplies Storage Bag with Handles and Adjustable Shoulder Strap and Removable Waist Straps, Waterproof Cleaning Tote for Home, Car, Office” (amazon.com) Sep. 3, 2023 Obtained from the internet URL:<https://www.amazon.com/dp/B0CH6FBPRL?ref=myi_title_dp>. Downloaded on May 7, 2024.

* cited by examiner

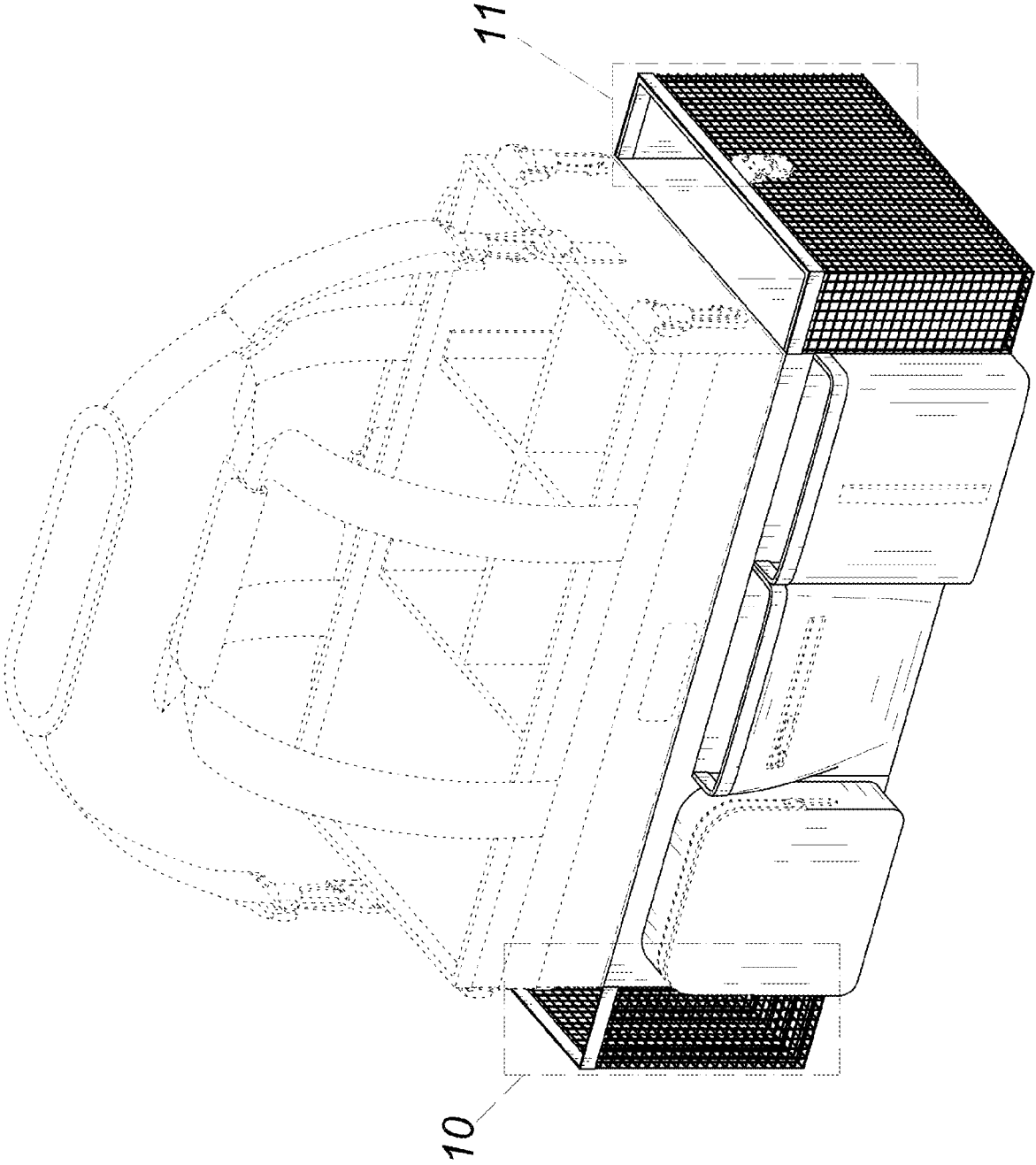

FIG. 1

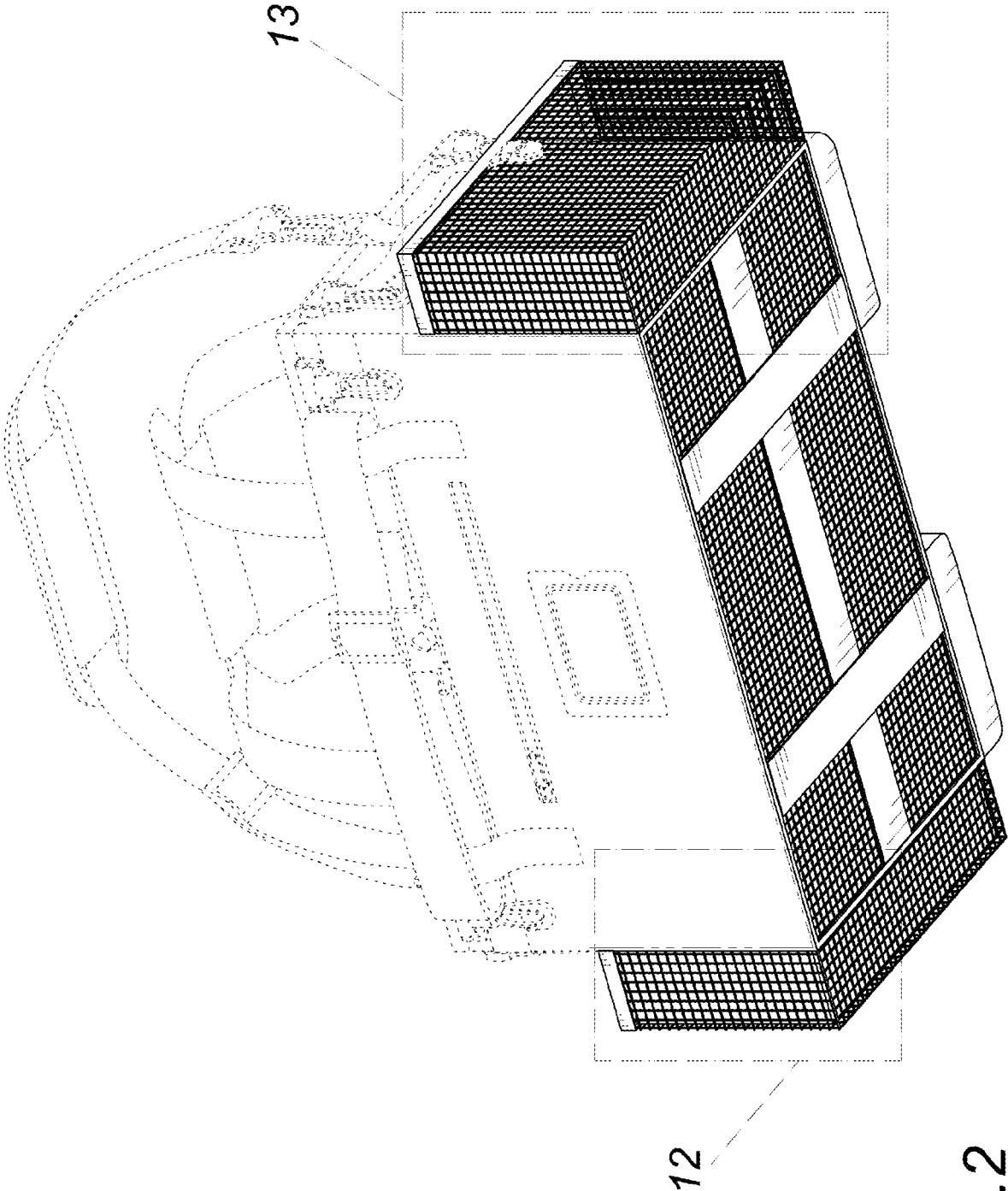

FIG.2

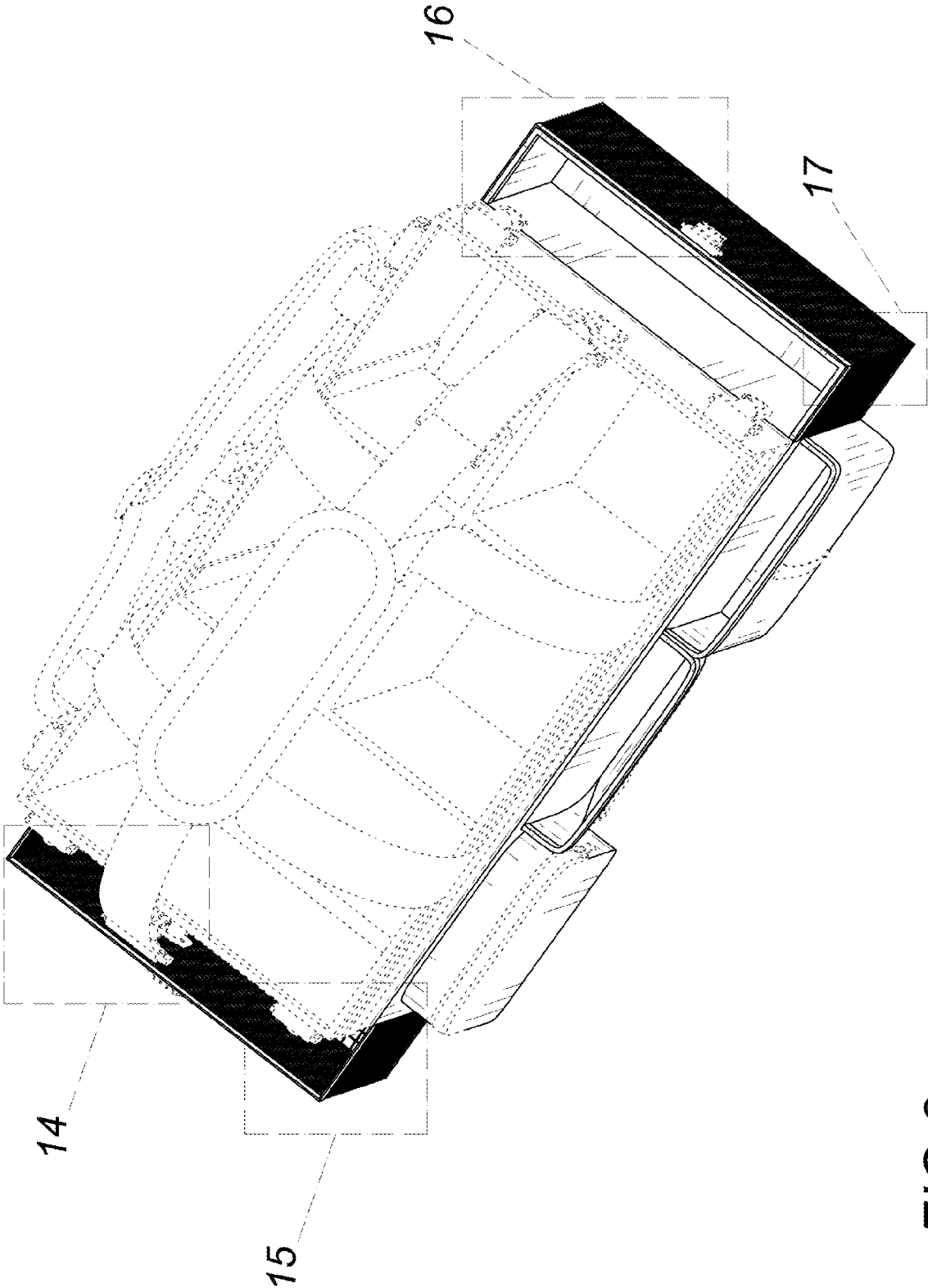

FIG.3

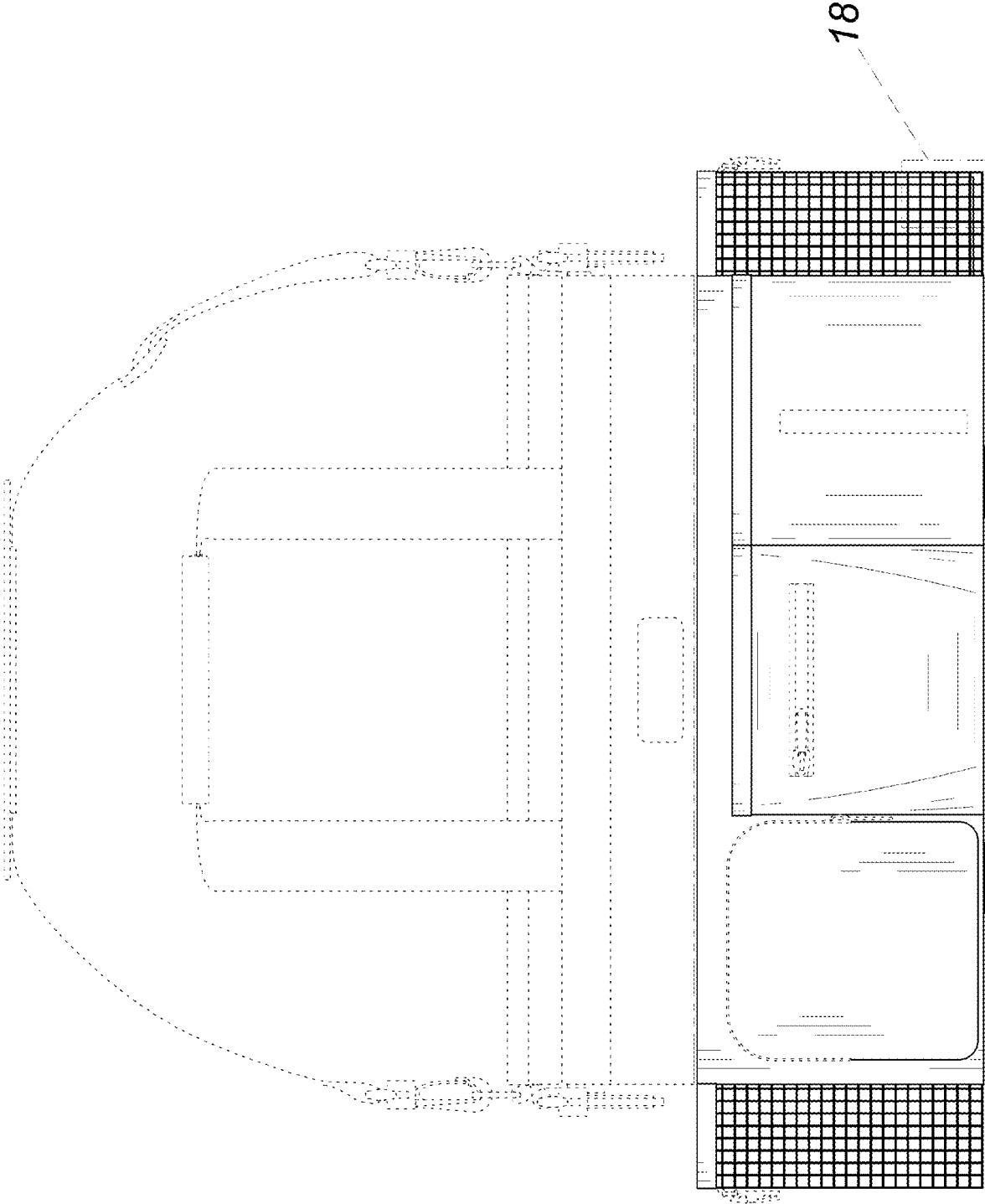

FIG. 4

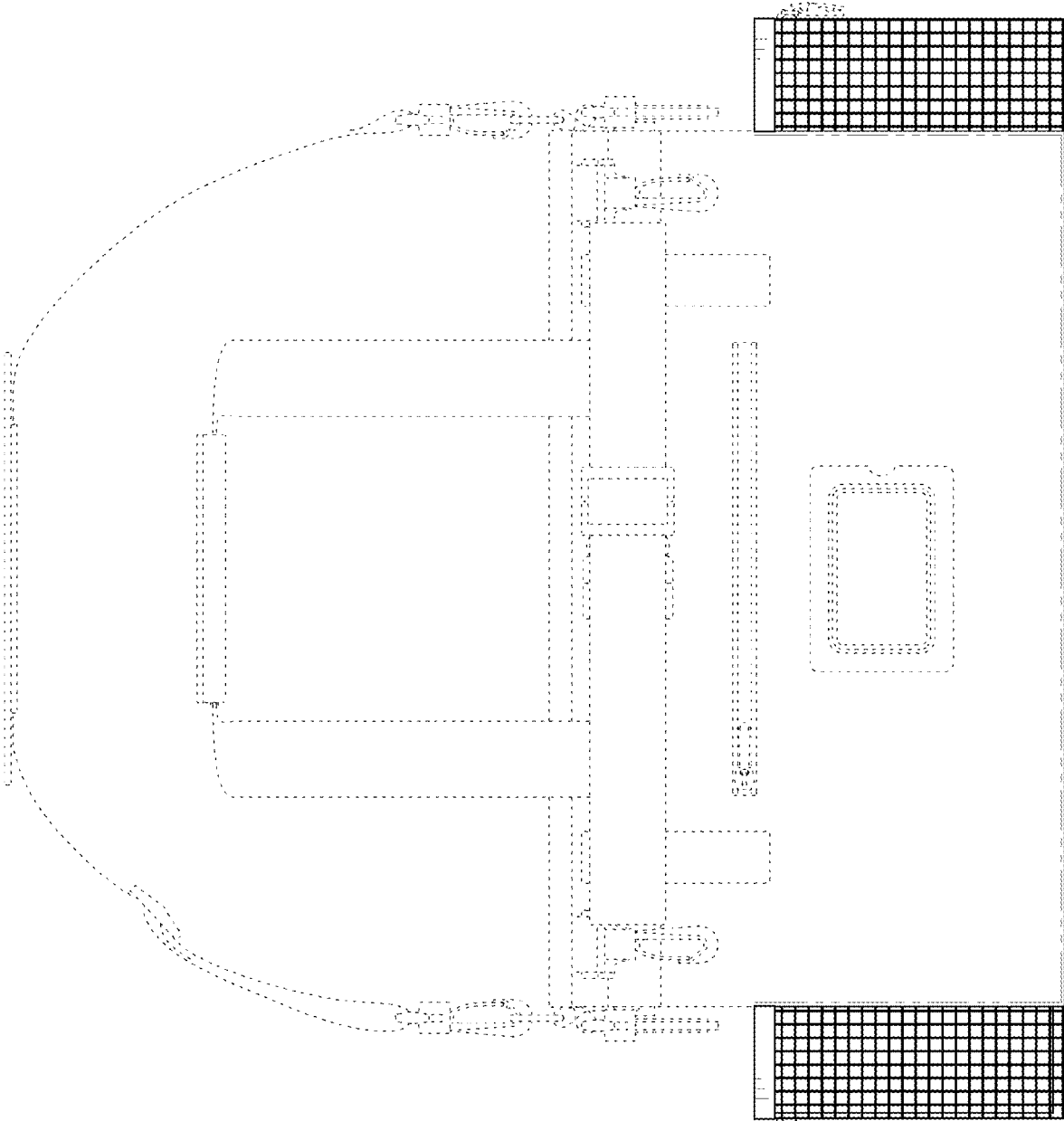

FIG. 5

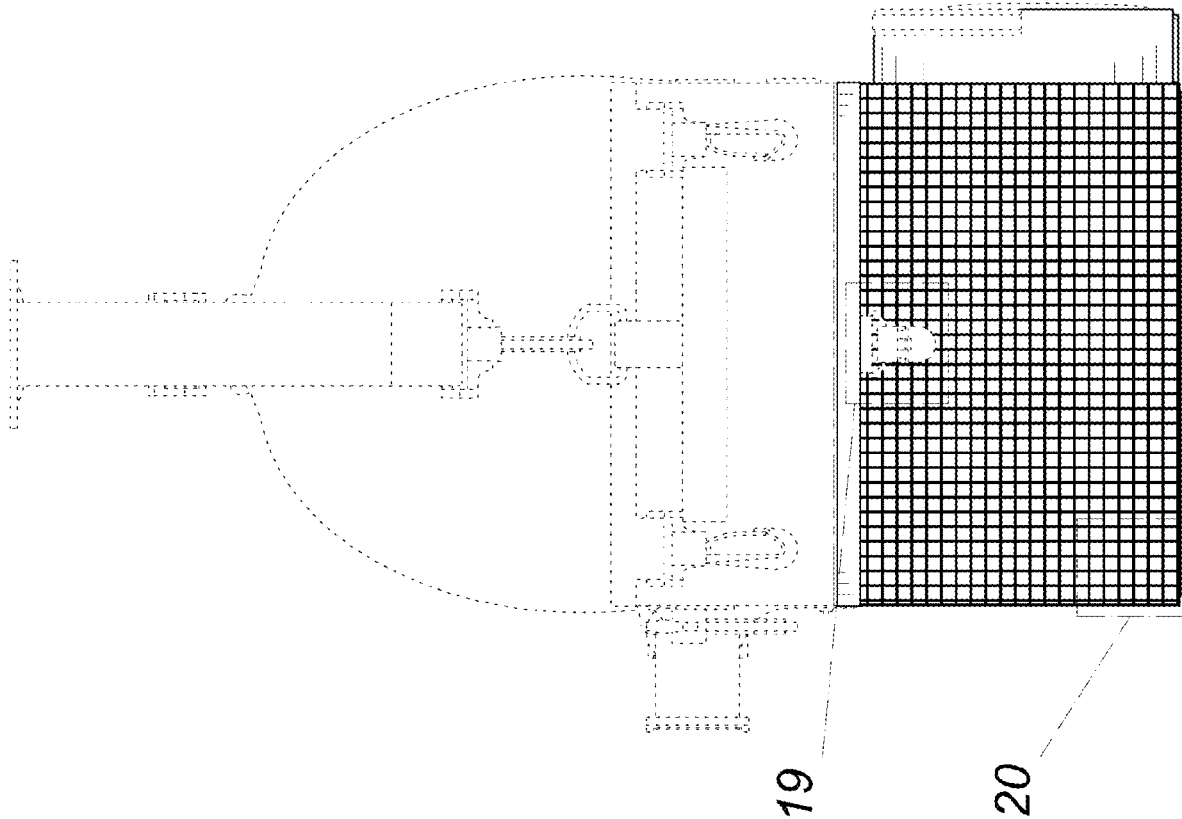

FIG.6

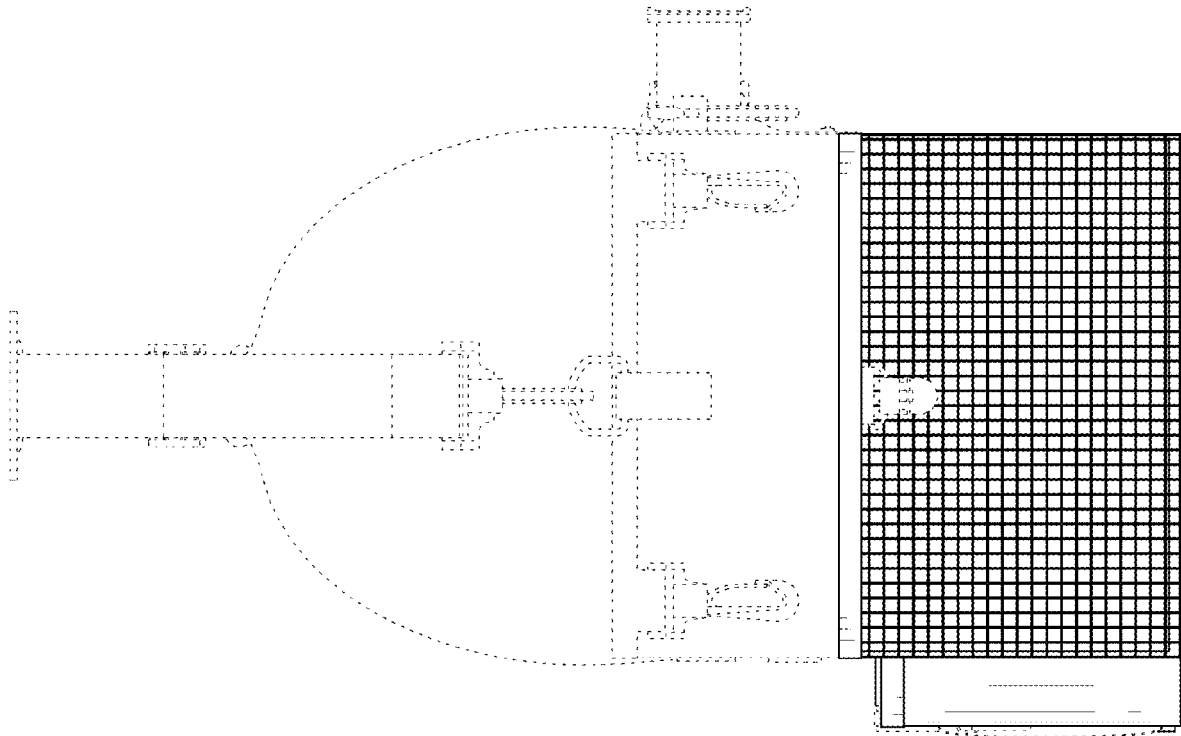

FIG. 7

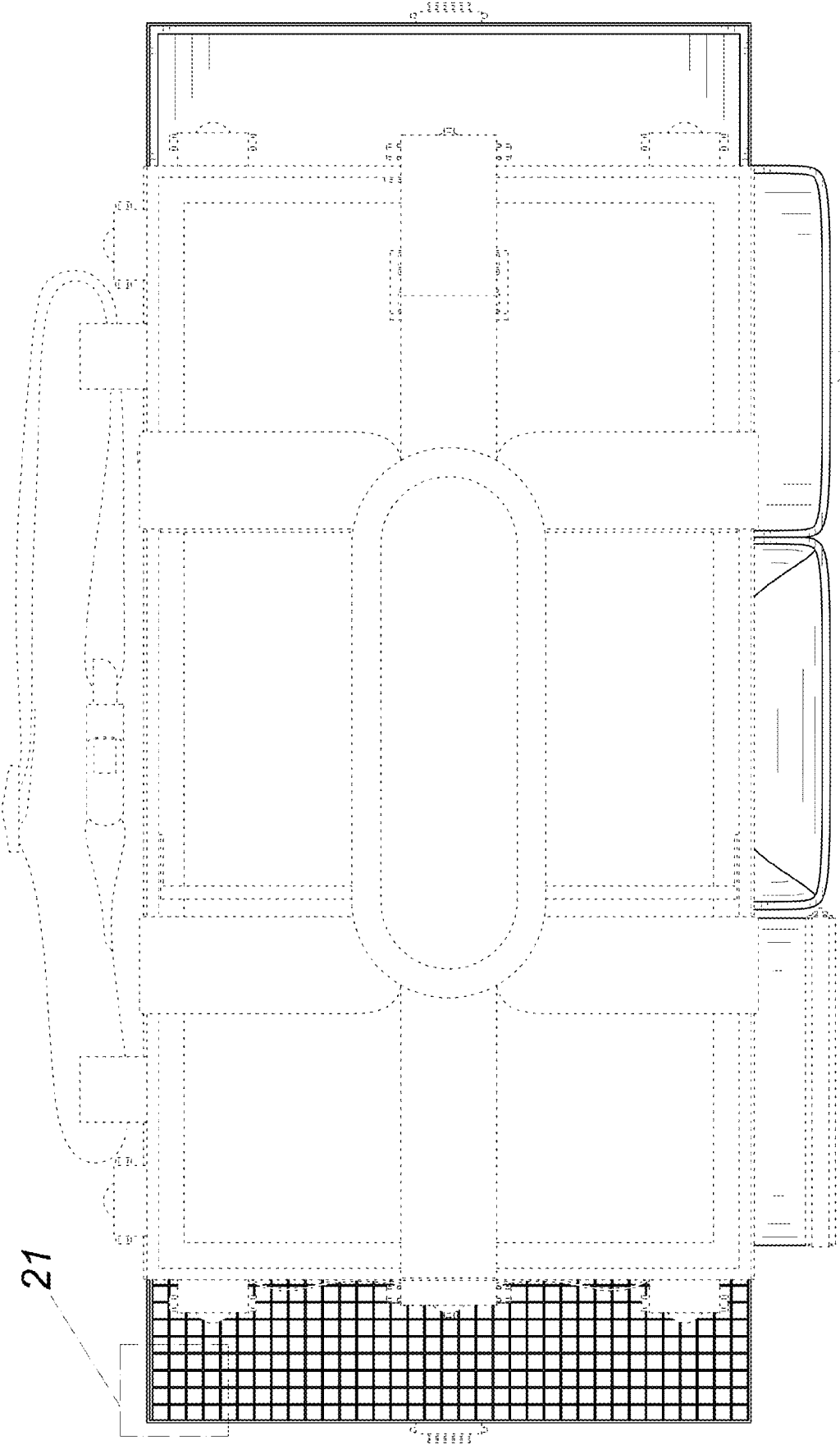

FIG.8

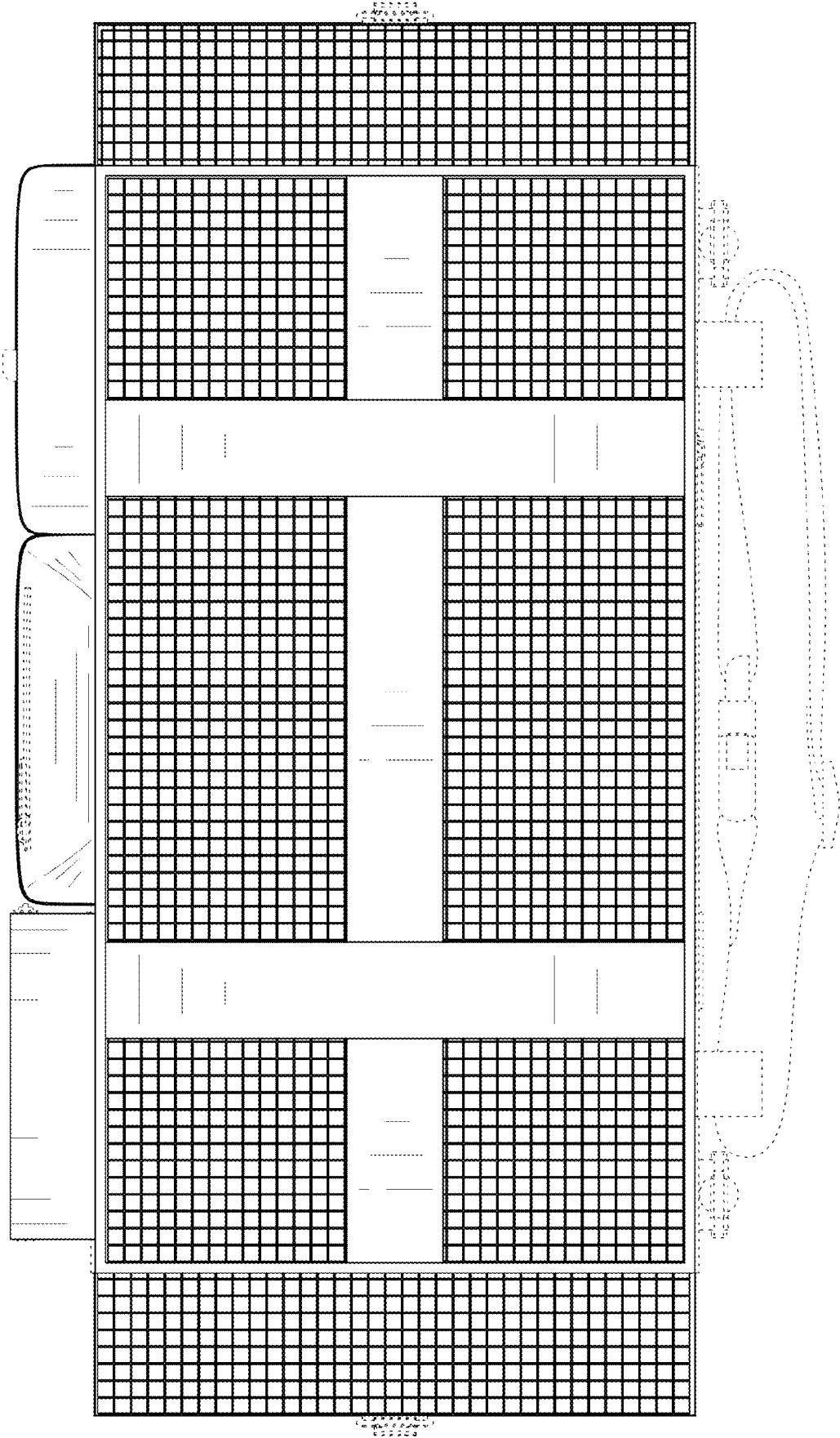

FIG.9

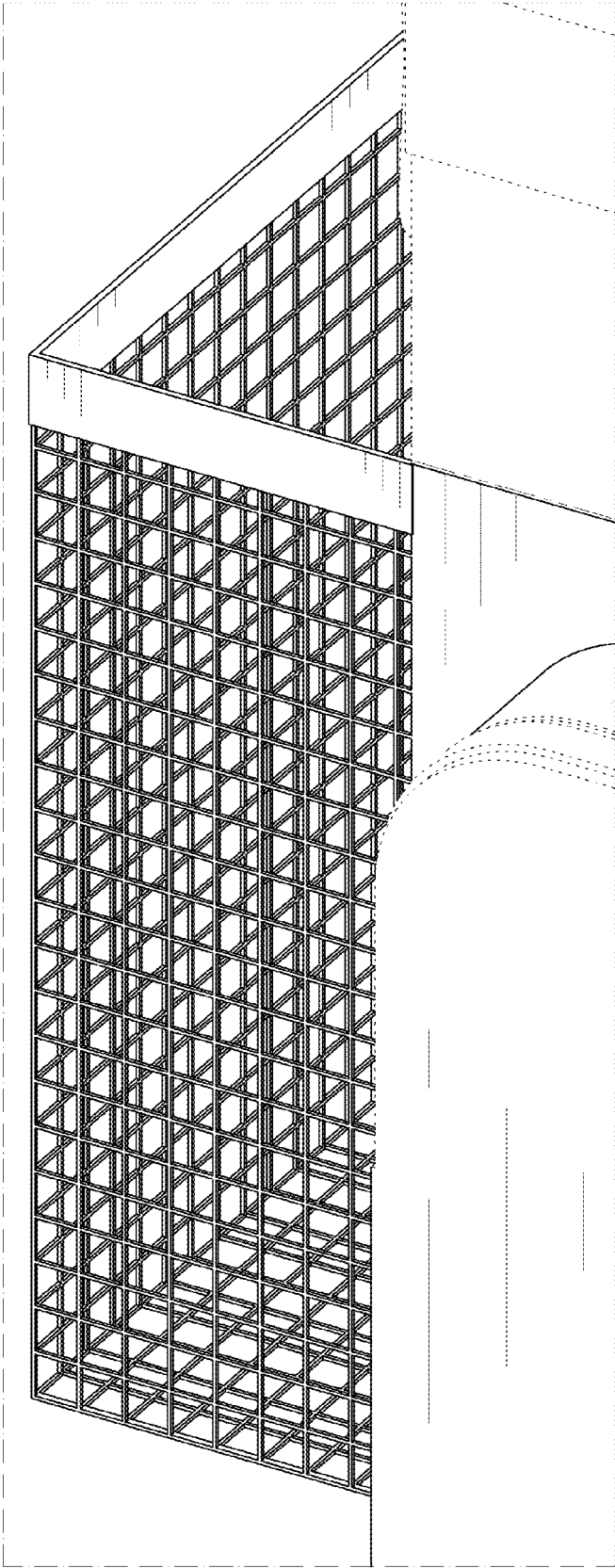

FIG. 10

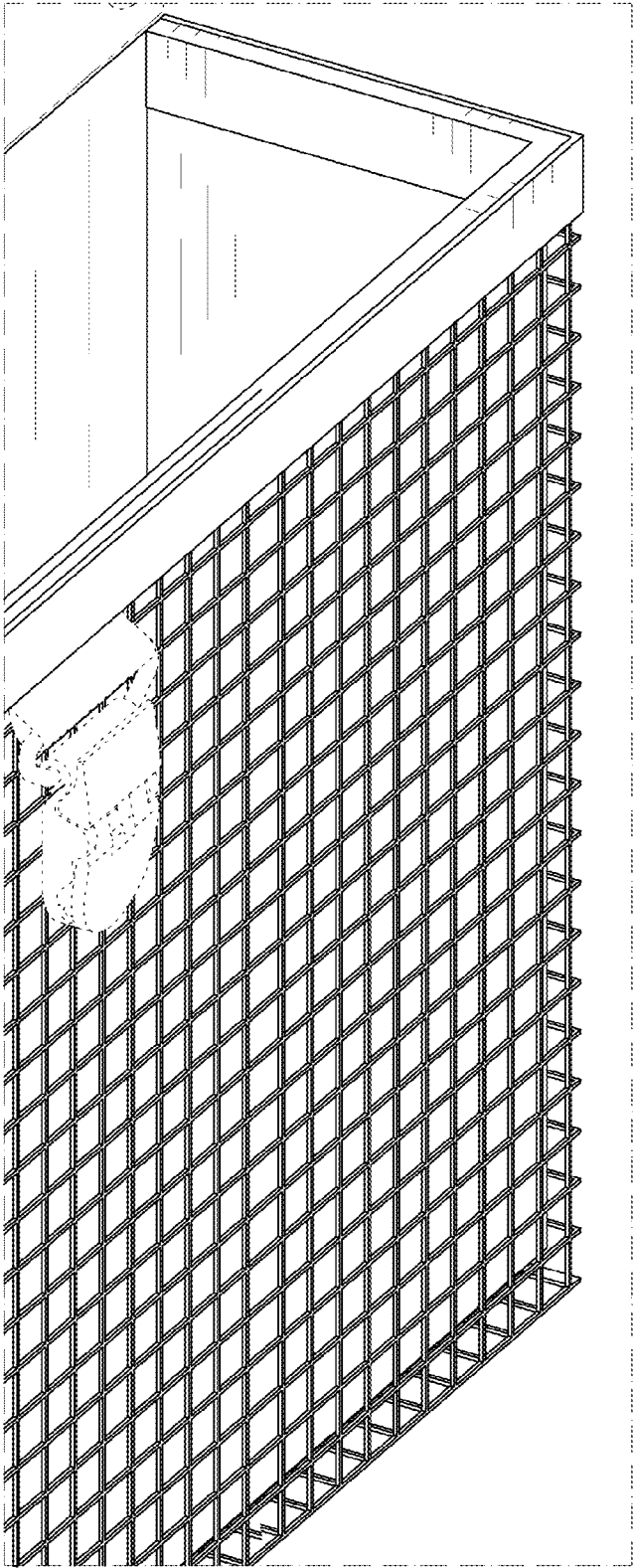

FIG. 11

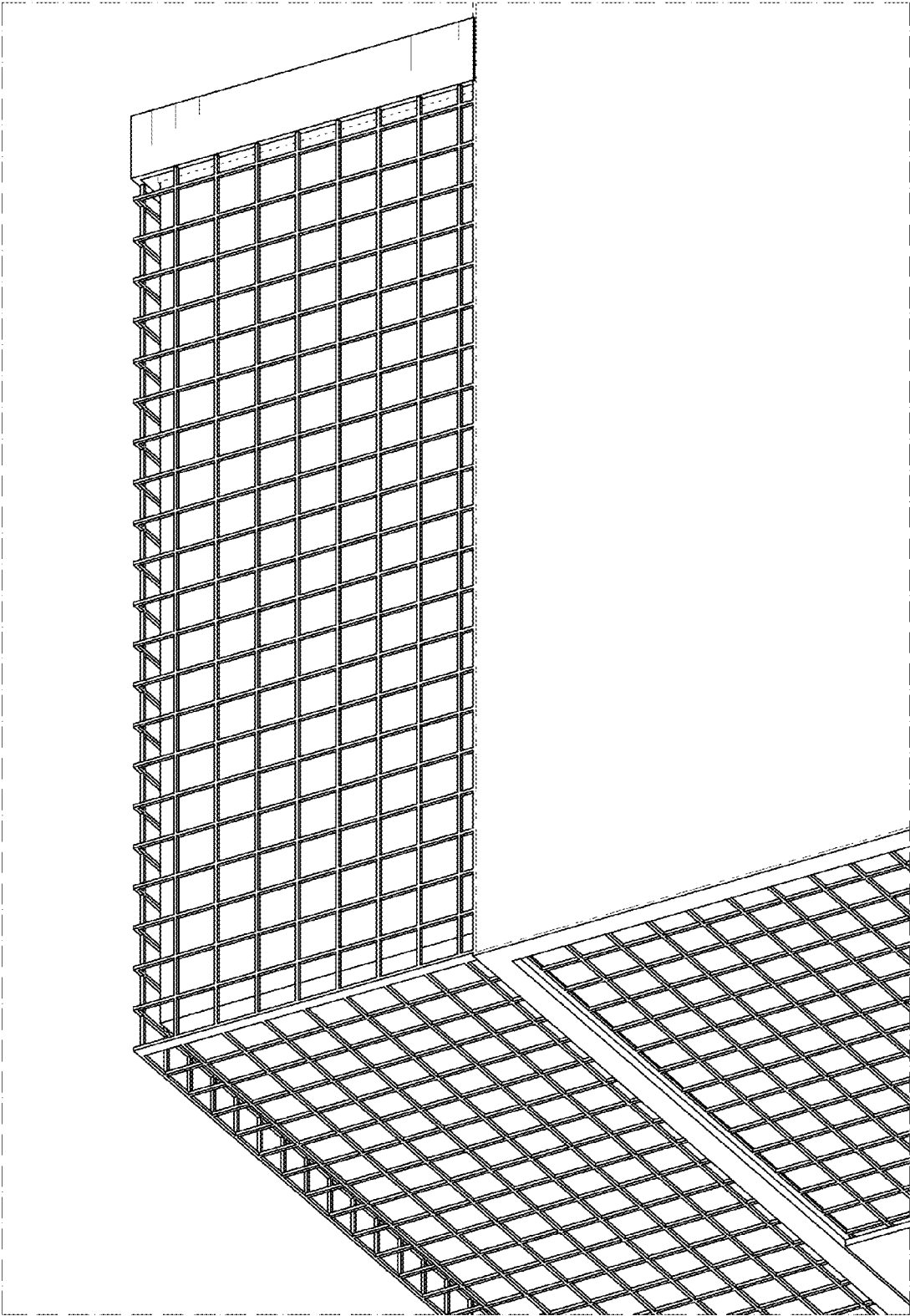

FIG.12

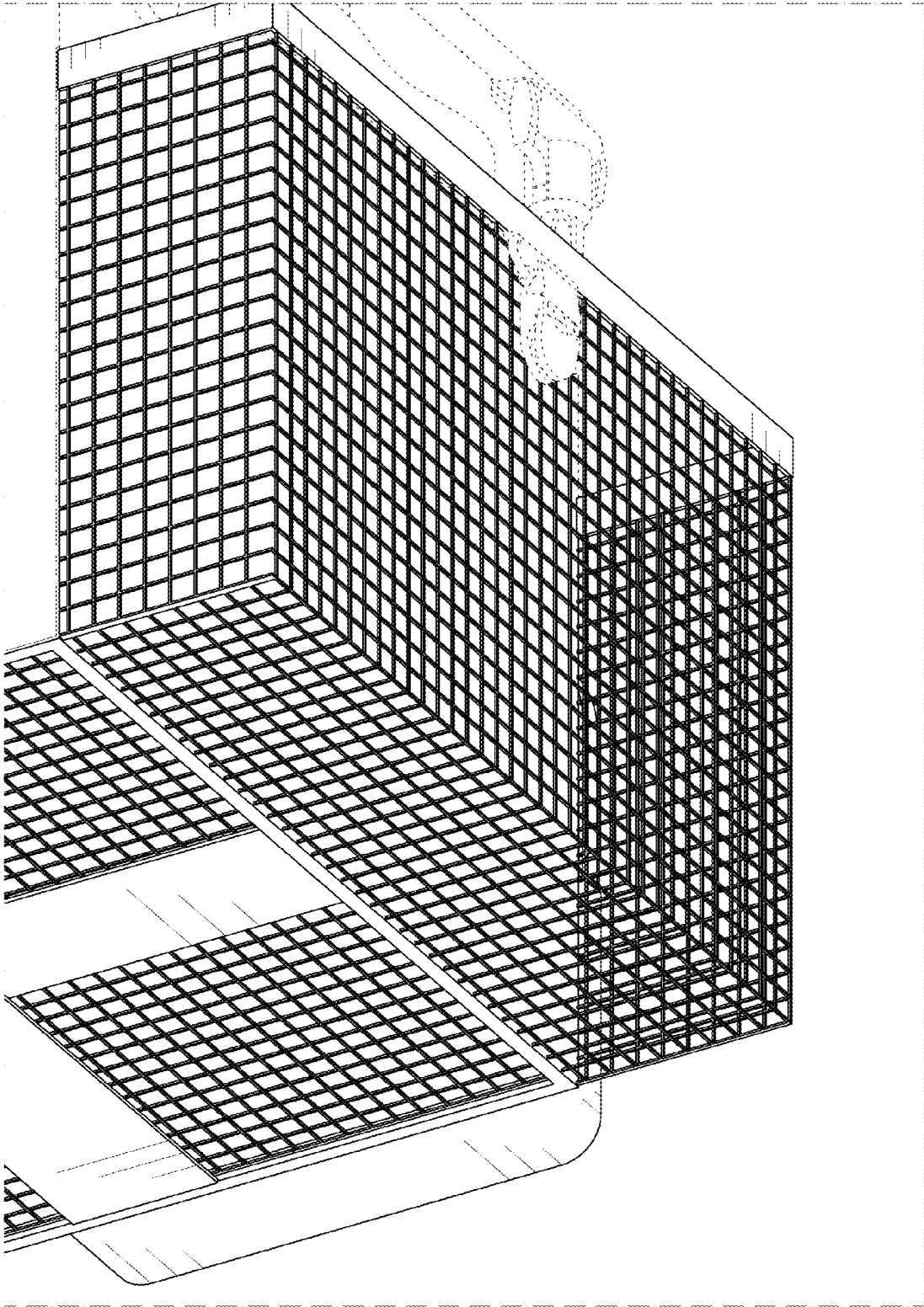

FIG. 13

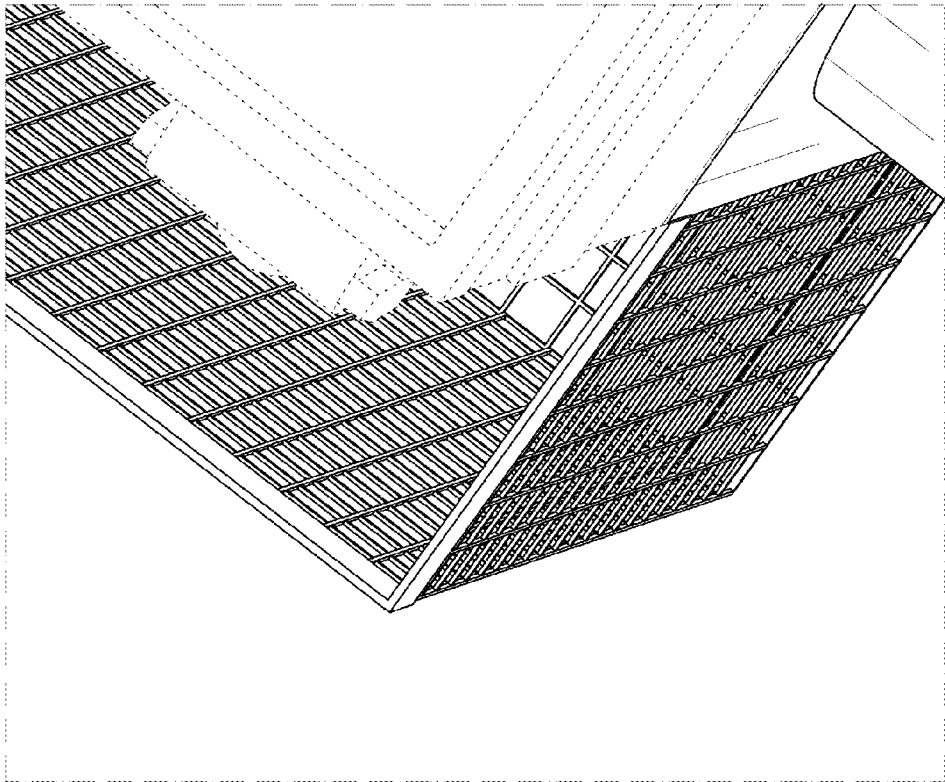

FIG. 15

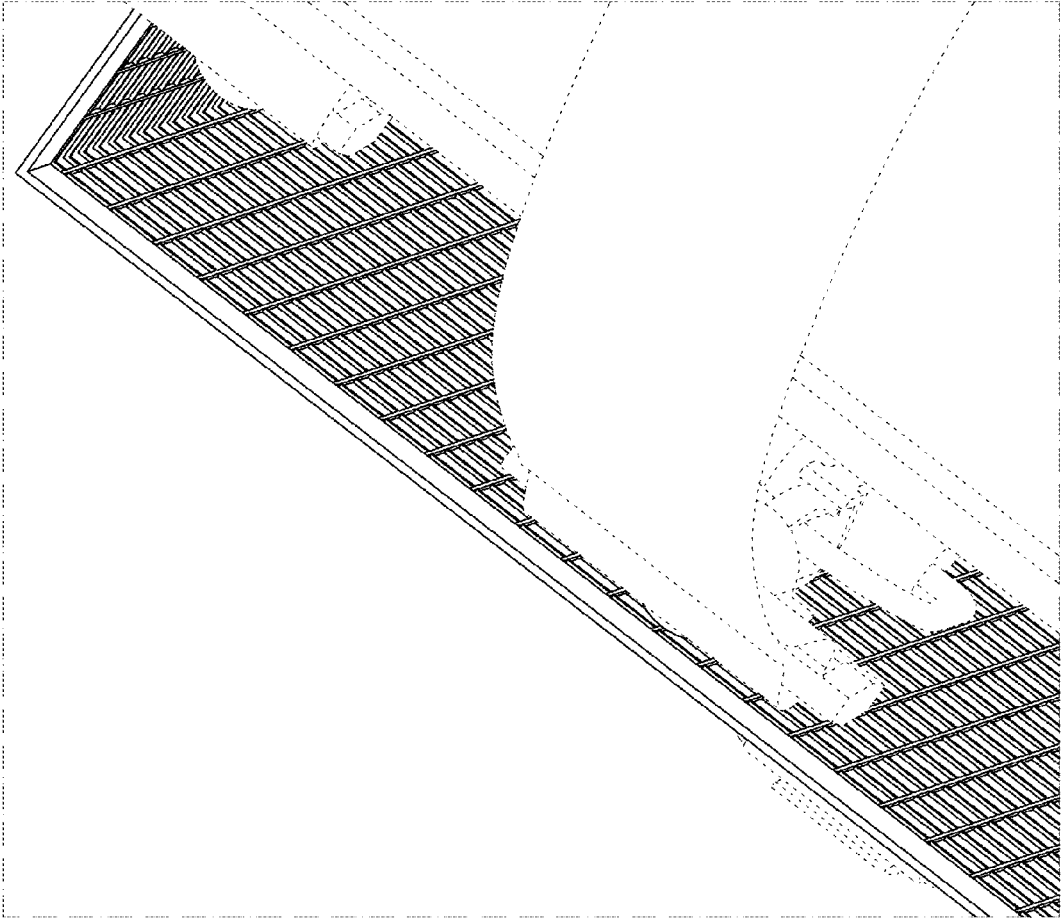

FIG. 14

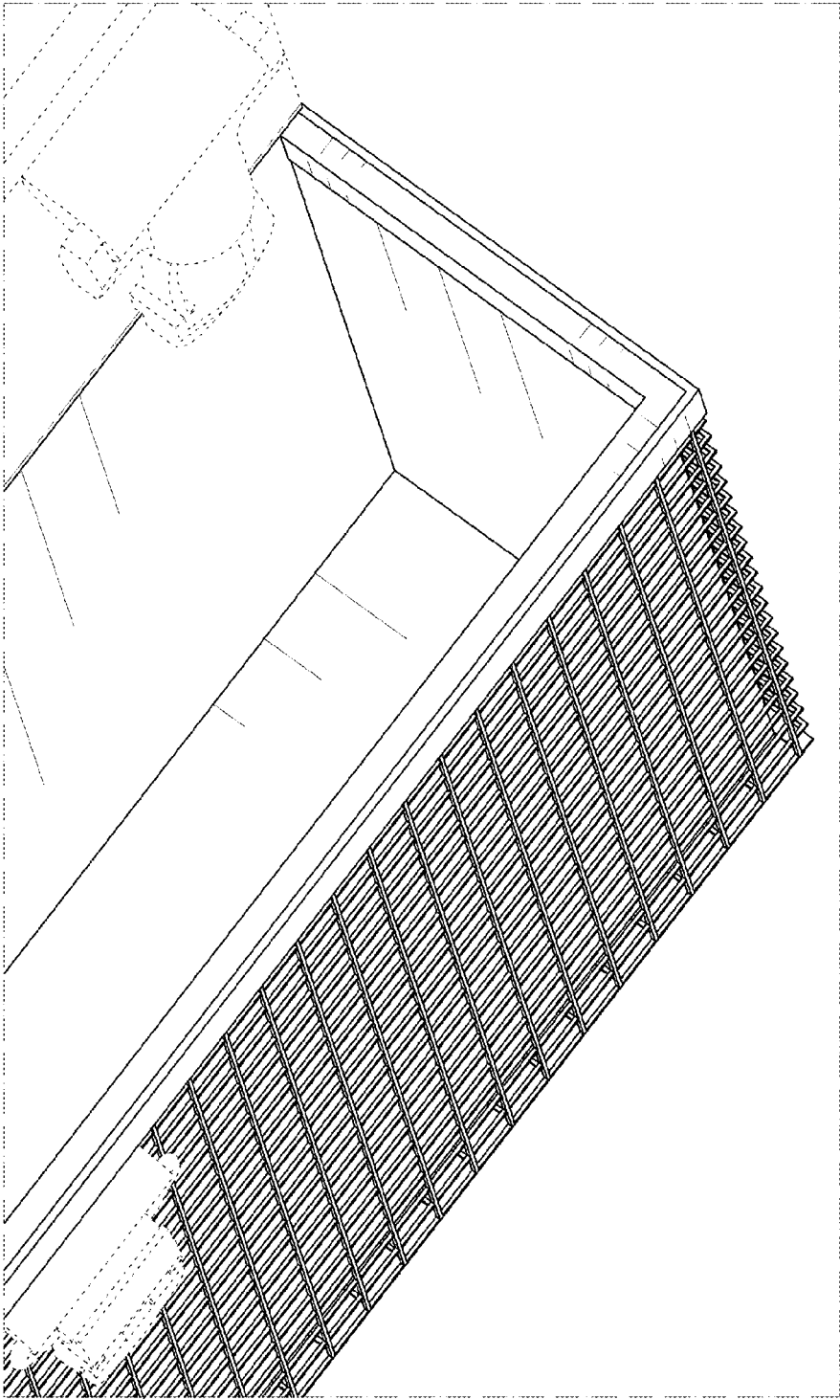

FIG. 16

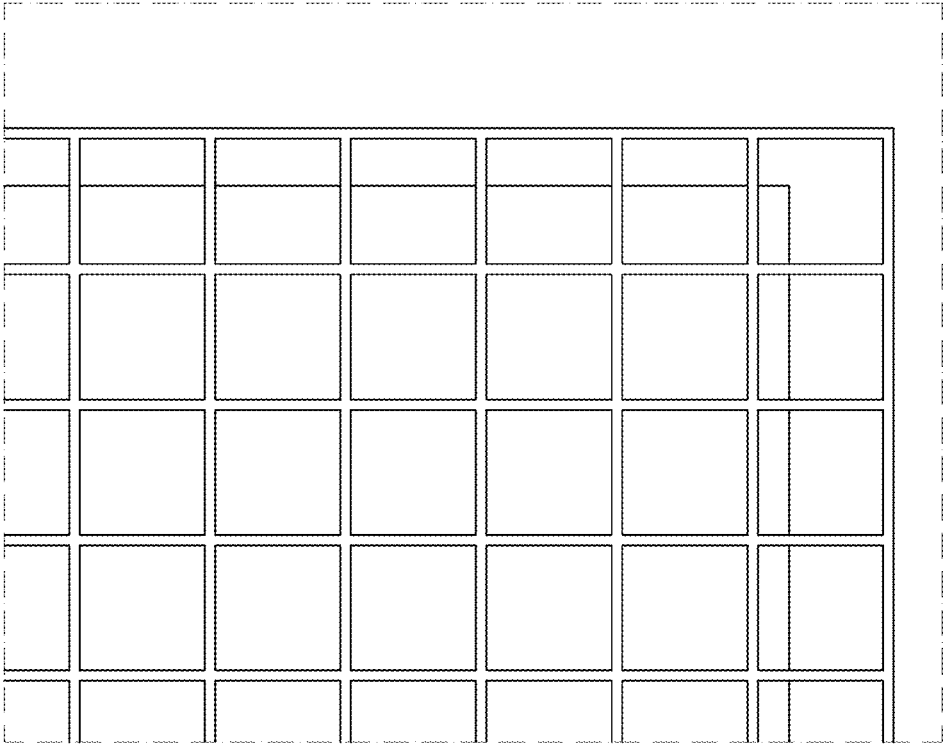

FIG. 18

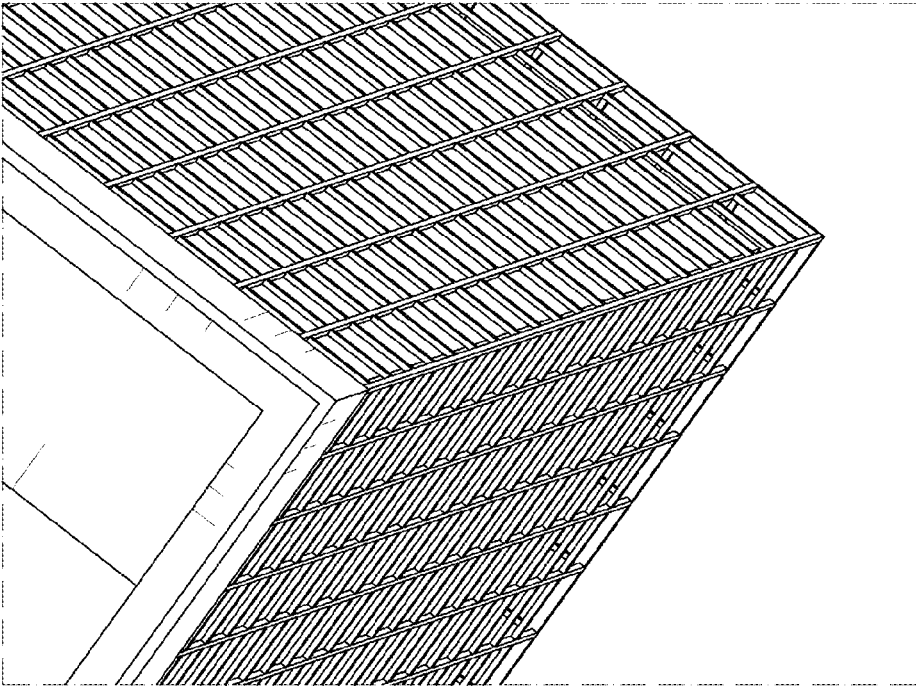

FIG. 17

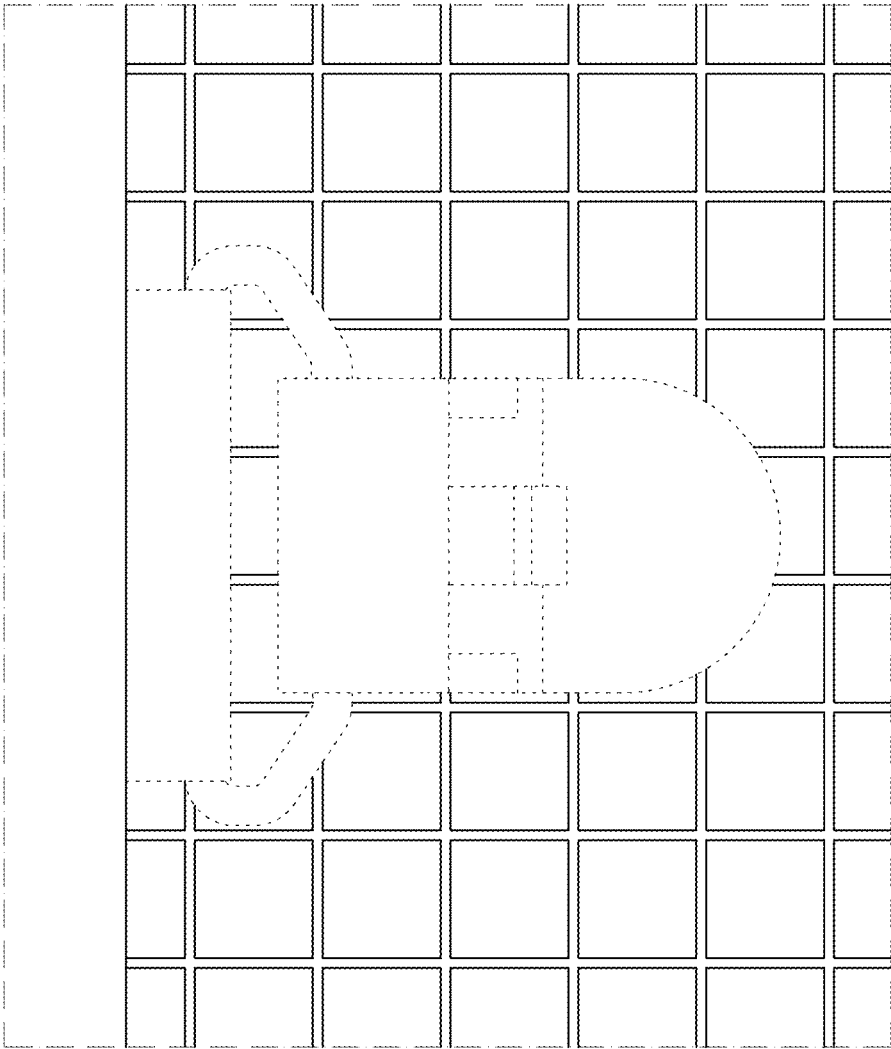

FIG. 19

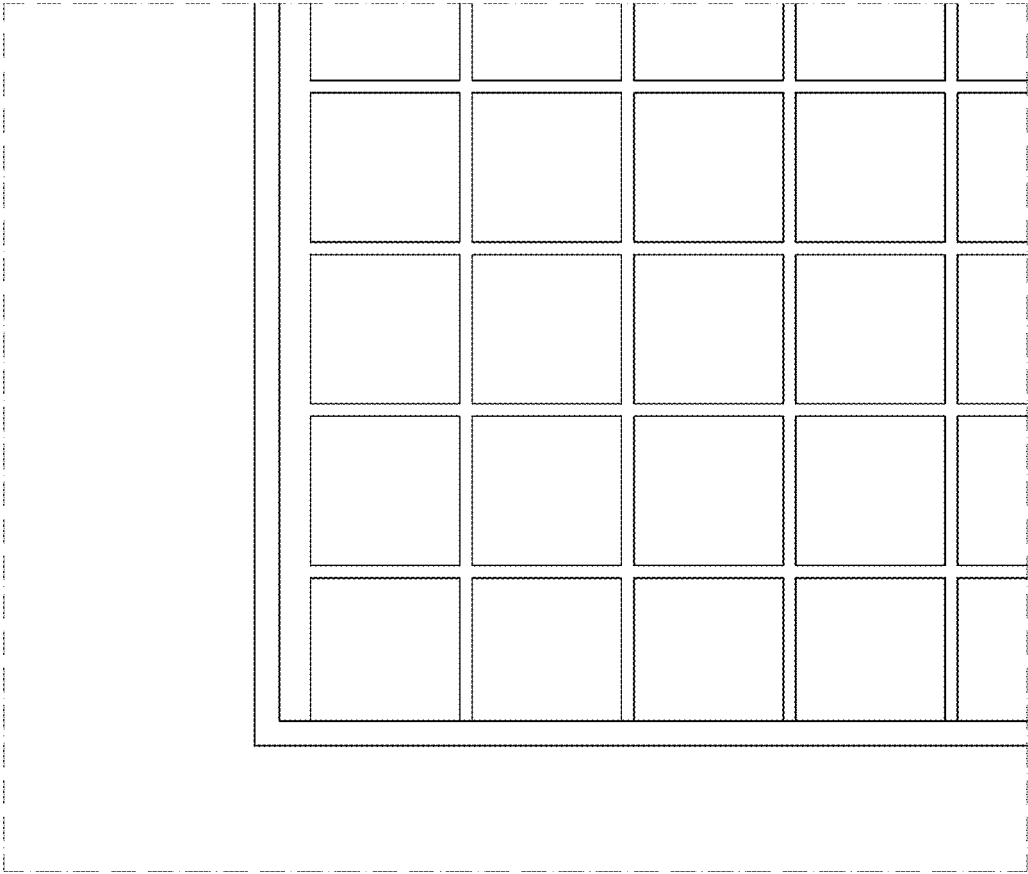

FIG. 21

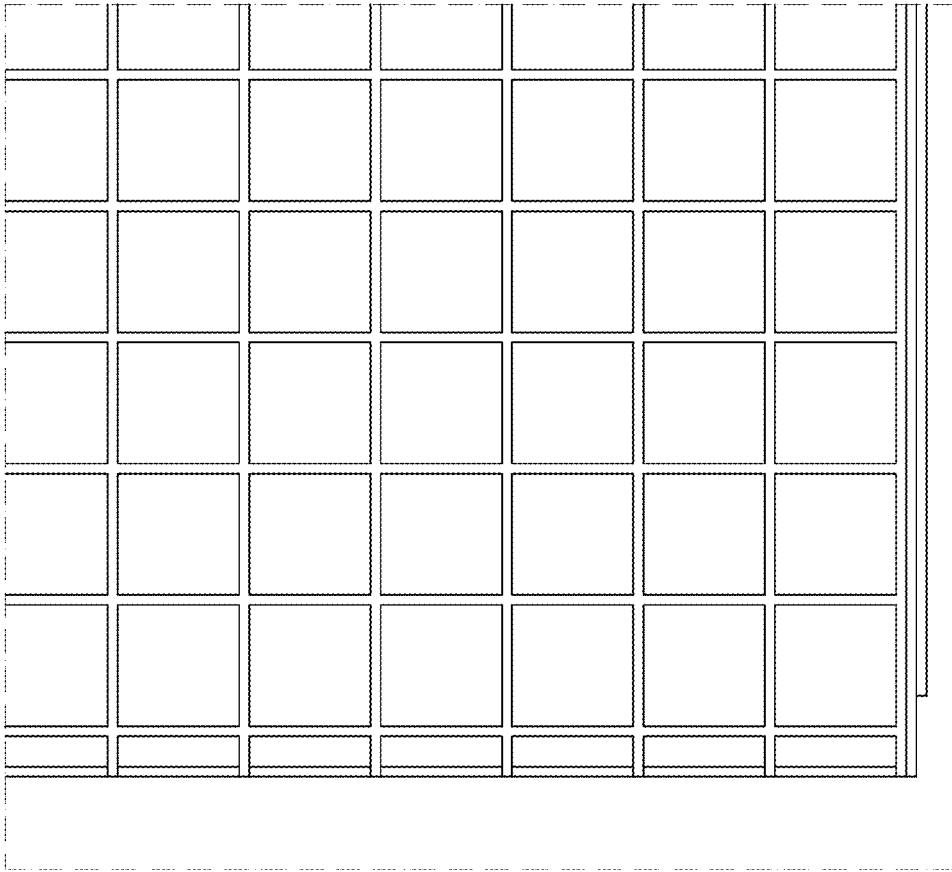

FIG. 20