



(12) **United States Design Patent**
Dsouza

(10) **Patent No.:** **US D987,369 S**
(45) **Date of Patent:** **** May 30, 2023**

- (54) **BAR GUN**
- (71) Applicant: **Lancer Corporation**, San Antonio, TX (US)
- (72) Inventor: **John Prakash Dsouza**, San Antonio, TX (US)
- (73) Assignee: **Lancer Corporation**, San Antonio, TX (US)
- (**) Term: **15 Years**
- (21) Appl. No.: **29/812,313**
- (22) Filed: **Oct. 20, 2021**
- (51) **LOC (14) Cl.** **07-06**
- (52) **U.S. Cl.**
USPC **D7/398**
- (58) **Field of Classification Search**
USPC D7/300, 306, 311, 313, 397, 398
CPC A47J 31/007; A47J 31/0573; A47J 31/402;
B67D 1/06; B67D 3/0009; B67D 3/00;
B67D 1/04; B67D 1/1405; B67D 1/02;
B67D 1/0079; B67D 1/0041; B67D 3/02;
F16K 11/0712; F16K 21/04; F16K 31/60;
F16K 31/607; F16K 7/16; F16K 7/20
See application file for complete search history.

- 4,497,421 A * 2/1985 Schilling B67D 1/0084
D7/395
- 4,986,449 A 1/1991 Valiyee et al.
- 5,042,692 A * 8/1991 Valiyee B67D 1/0084
285/305
- D326,375 S 5/1992 Manley et al.
- 7,028,864 B2 4/2006 McCann et al.
(Continued)

OTHER PUBLICATIONS

8 button bar gun. Posted at edco-distributing.myshopify.com, no posting date [online], [site visited in U.S. Appl. No. 29/761,868, filed Mar. 9, 2022]. Available from Internet, <URL: https://edco-distributing.myshopify.com/products/bar-gun-851-8-button-black-5-non-carb-soda-water> (Year: 2022).
(Continued)

Primary Examiner — Joseph Kukella
Assistant Examiner — Darryl J Dardenne

(57) **CLAIM**

The ornamental design for a bar gun, as shown and described.

DESCRIPTION

FIG. 1 is top front perspective view of a bar gun according to the design;
FIG. 2 is a bottom rear perspective view of the bar gun;
FIG. 3 is a front view of the bar gun;
FIG. 4 is a rear view of the bar gun;
FIG. 5 is a right side view of the bar gun;
FIG. 6 is a left side view of the bar gun;
FIG. 7 is a top view of the bar gun; and,
FIG. 8 is a bottom view of the bar gun.
The dash-dash broken lines in the drawing views depict portions of the bar gun that form no part of the claimed design. The dot-dot-dash broken lines in the drawing views define bounds of the claimed design and form no part thereof.

(56) **References Cited**

U.S. PATENT DOCUMENTS

- D194,343 S * 1/1963 Zilk B67D 1/0872
D7/398
- D203,151 S * 12/1965 Easley B67D 1/0084
D7/398
- 3,749,527 A * 7/1973 Slagle F04B 43/06
91/402
- 4,162,028 A * 7/1979 Reichenberger B67D 1/0046
222/144.5
- 4,433,795 A 2/1984 Maiefski
- D274,031 S * 5/1984 de Man B67D 1/08
D7/398

1 Claim, 6 Drawing Sheets

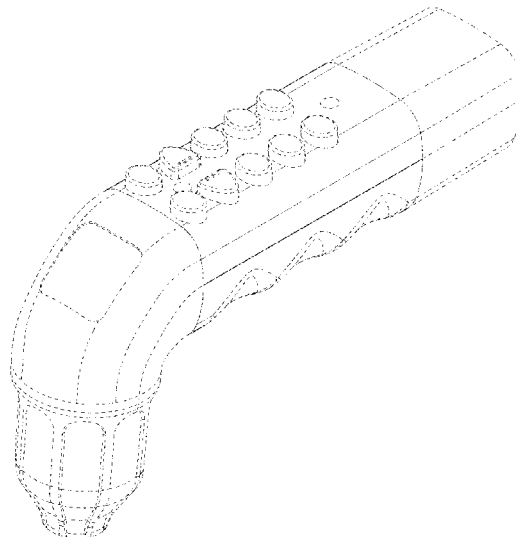

(56)

References Cited

U.S. PATENT DOCUMENTS

7,658,006 B2 2/2010 Schroeder
 D626,373 S 11/2010 Valiyee et al.
 D626,374 S 11/2010 Valiyee et al.
 D628,014 S 11/2010 Martindale
 7,931,382 B2 4/2011 Hecht
 D638,659 S 5/2011 Martindale et al.
 8,109,413 B2 2/2012 Schroeder et al.
 8,162,182 B2 4/2012 Martindale
 D666,689 S 9/2012 Martindale et al.
 D666,869 S 9/2012 Martindale et al.
 8,459,505 B2 6/2013 Martindale et al.
 D697,753 S 1/2014 Brown
 8,814,003 B2 8/2014 Santy et al.
 D717,590 S 11/2014 Bond
 D717,591 S 11/2014 Bond
 D717,592 S 11/2014 Bond
 D717,593 S 11/2014 Bond
 D758,795 S 6/2016 Bond et al.
 D786,616 S 5/2017 Brown
 10,035,694 B1 7/2018 Broen et al.
 D827,366 S 9/2018 Broen et al.
 D842,647 S * 3/2019 Broen B67D 1/0086
 D20/43
 11,358,853 B2 * 6/2022 Wells B67D 1/08

D957,187 S * 7/2022 Behe F04B 43/06
 D7/397
 2010/0320231 A1 * 12/2010 Martindale B67D 1/0872
 222/113
 2011/0073617 A1 3/2011 Martindale et al.
 2012/0325855 A1 12/2012 Brown et al.
 2013/0119089 A1 * 5/2013 Tuyls B67D 1/0084
 165/104.11
 2016/0010763 A1 * 1/2016 Hecht B67D 1/06
 248/75
 2016/0060091 A1 3/2016 Hecht et al.
 2016/0176696 A1 * 6/2016 Hecht B67D 1/0086
 222/144.5
 2017/0129760 A1 * 5/2017 Aneson B08B 9/00
 2021/0147208 A1 * 5/2021 Yanes B67D 1/0086
 2021/0380389 A1 * 12/2021 Martin B67D 1/0888

OTHER PUBLICATIONS

“Taprite—Rattler Bar Beverage Dispensers”, posted at taprite.com, dated Jan. 17, 2021, <<https://www.taprite.com/rattler-bar-beverage-dispensers>>.
 “Bargun Sales Sheet”, downloaded from www.wunderbar.com/products/details/bargun on Jan. 17, 2021, <https://www.wunderbar.com/assets/upload/product_specs/Wunder-Bar_BarGunSalesSheet_041118.pdf>.

* cited by examiner

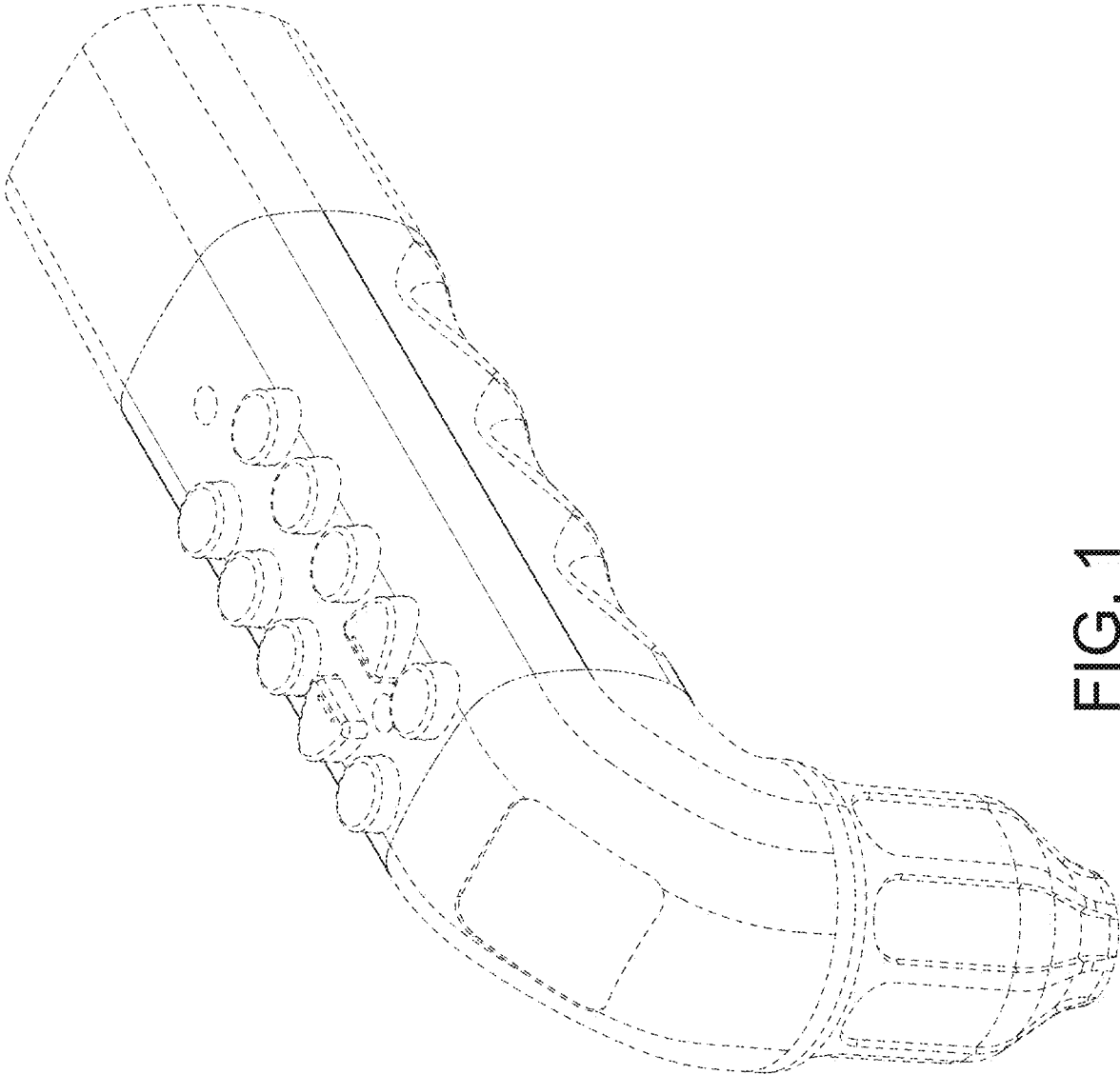

FIG. 1

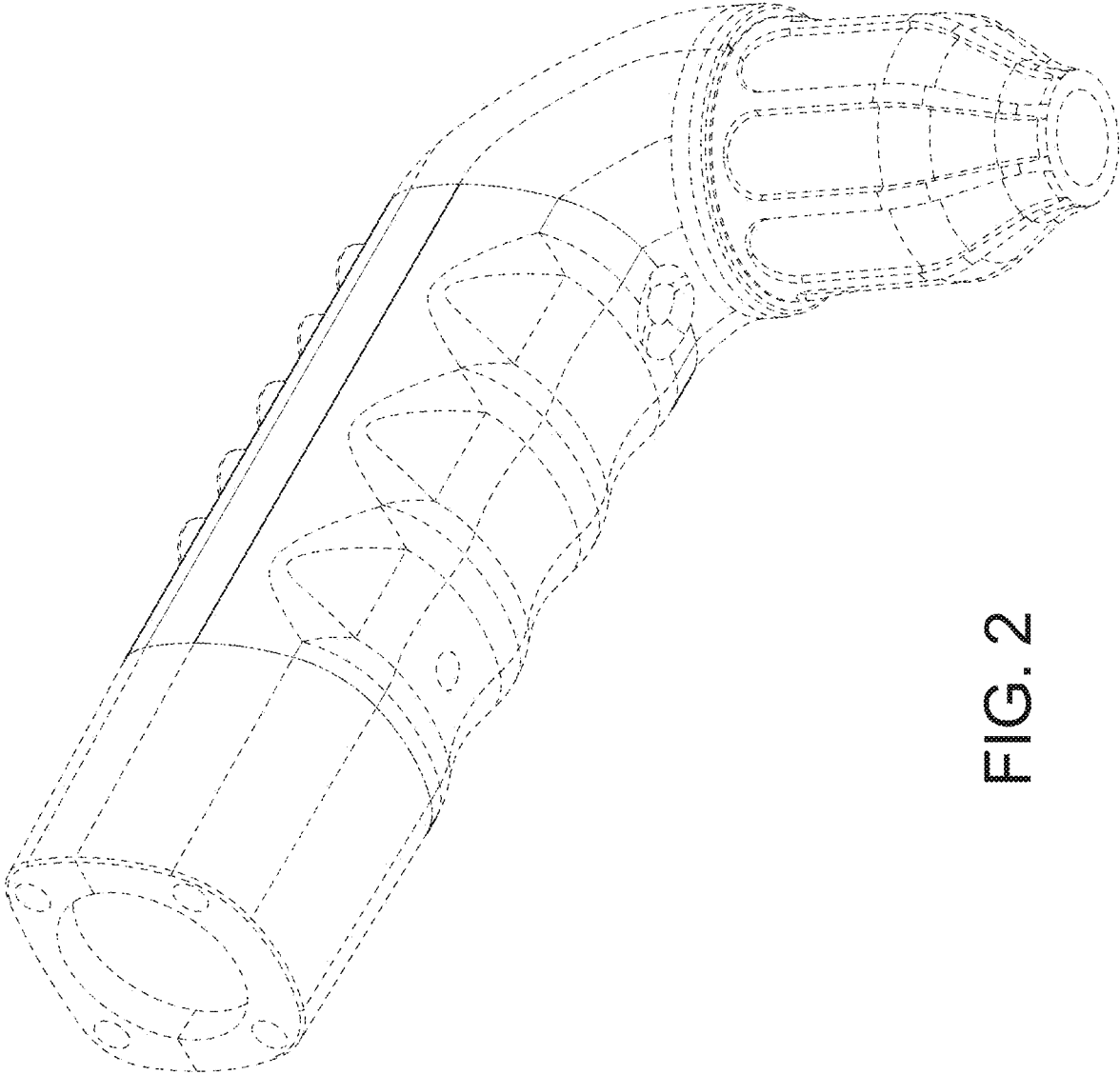

FIG. 2

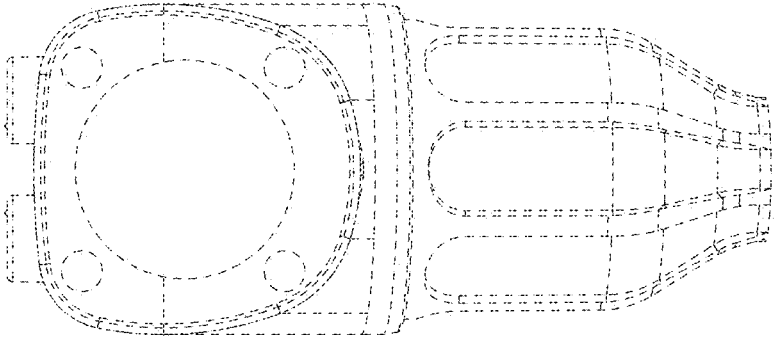

FIG. 4

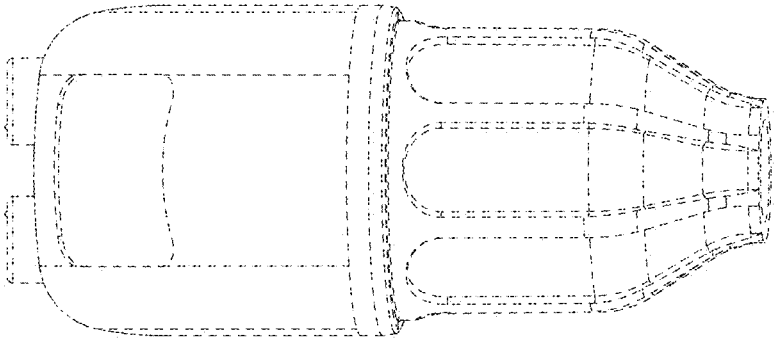

FIG. 3



FIG. 5

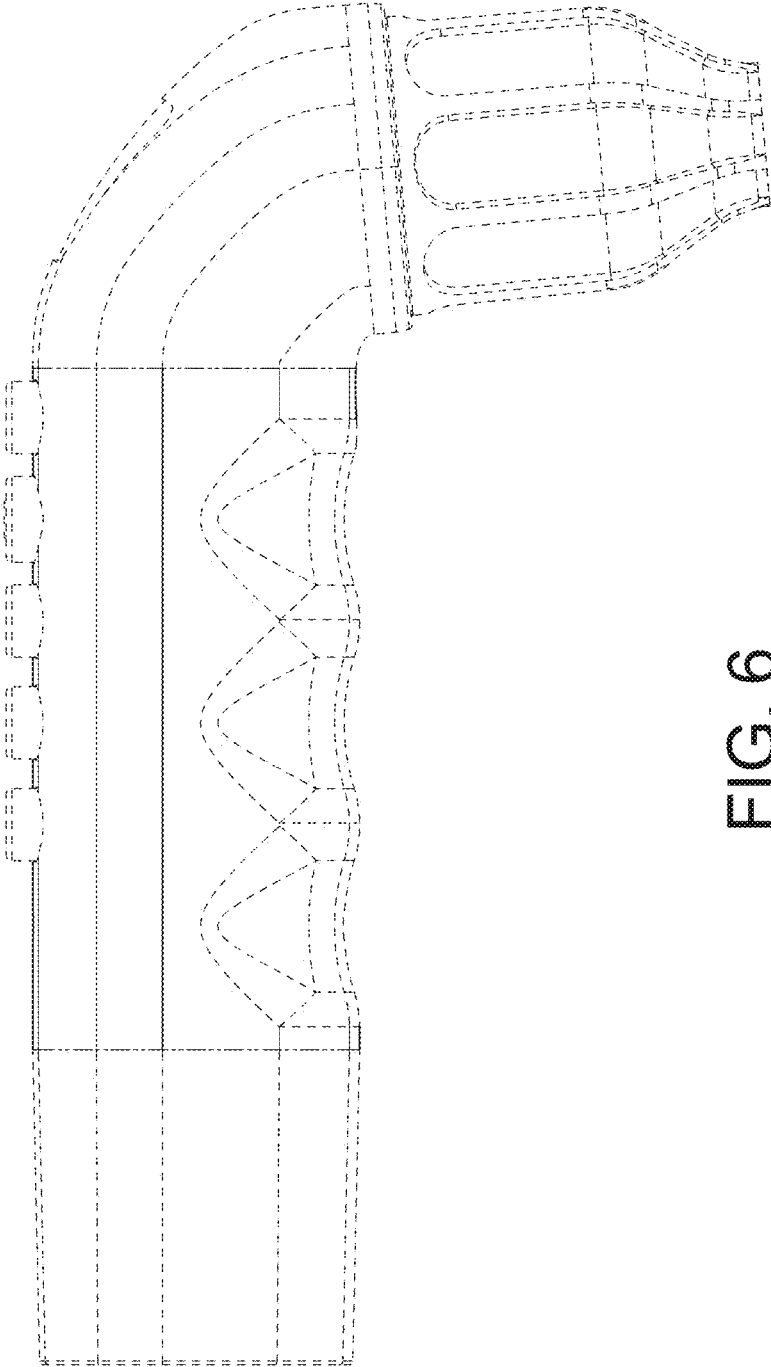

FIG. 6

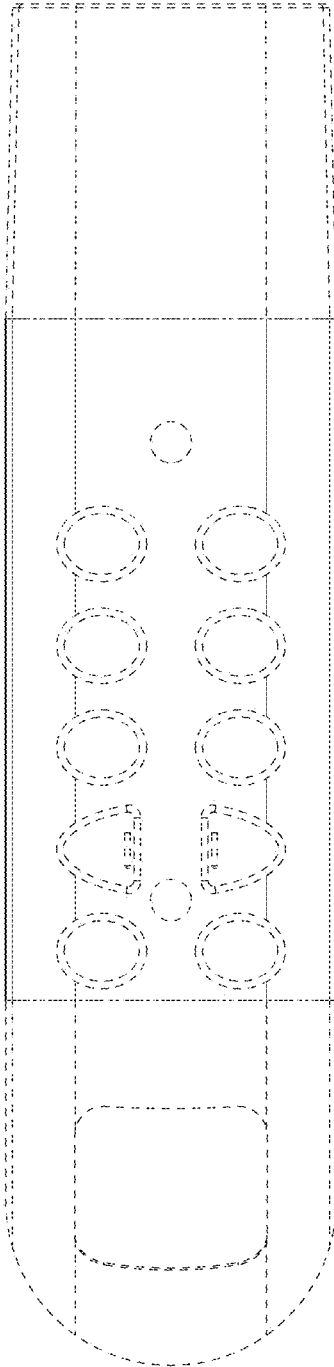

FIG. 7

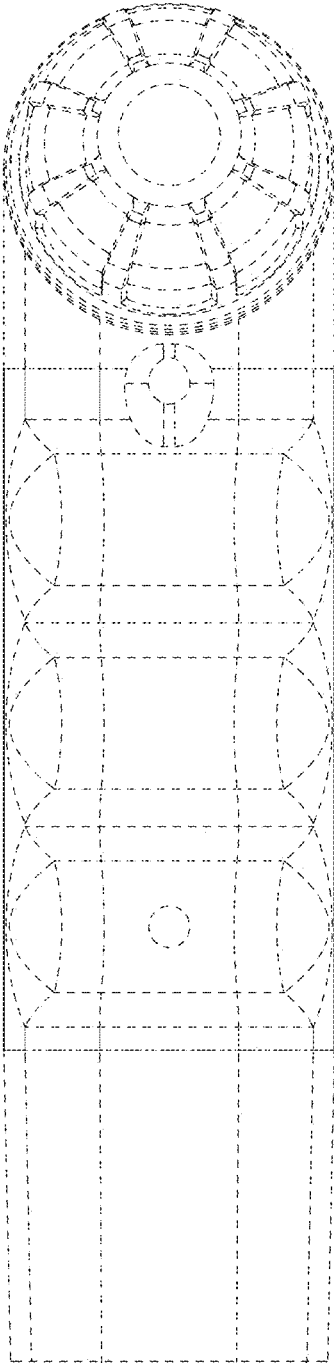

FIG. 8