



US00D346958S

United States Patent [19]
Olson

[11] **Patent Number: Dés. 346,958**
[45] **Date of Patent: ** May 17, 1994**

[54] **SOAP CONTAINER**
[76] **Inventor: Scott D. Olson, Wheeler AFB, Bldg. 102, Rm. 303, Honolulu, Hi. 96854**
[**] **Term: 14 Years**
[21] **Appl. No.: 881,559**
[22] **Filed: May 14, 1992**
[52] **U.S. Cl. D9/307; D7/591; D9/337**
[58] **Field of Search D9/307, 337, 504, 515, D9/529; D7/590, 591, 594, 597; 252/89.1; 222/142.4, 565**

2,582,313 1/1952 Dodson 222/142.4
3,428,238 2/1969 Shelby et al. D9/515 X
3,494,515 2/1970 Fattori D9/515 X
4,928,857 5/1990 Ecker 222/211
4,982,874 1/1991 Pringle 222/211
5,058,778 10/1991 Weinstein 222/211
5,192,005 3/1993 Zimmerman 222/565 X

Primary Examiner—Bernard Ansher
Assistant Examiner—M. Siegel
Attorney, Agent, or Firm—Terry M. Gernstein

[57] **CLAIM**

The ornamental design for a soap container, as shown and described.

[56] **References Cited**

U.S. PATENT DOCUMENTS

D. 19,120 5/1889 Steffin D7/594
D. 147,731 10/1947 Kaminski D7/594
D. 266,390 10/1982 Haner D7/597
D. 277,077 1/1985 Kaneko D9/542 X
D. 278,121 3/1985 Sussman D9/504
D. 336,728 6/1993 Ancona et al. D7/591
1,997,492 4/1935 Lirio 222/565

DESCRIPTION

FIG. 1 is an exploded perspective view of a soap container showing my new design;
FIG. 2 is a front elevational view, the undisclosed opposite side being identical;
FIG. 3 is a side elevational view of FIG. 2, the undisclosed opposite side being identical;
FIG. 4 is a top plan view of FIG. 2; and,
FIG. 5 is a bottom plan view of FIG. 2.

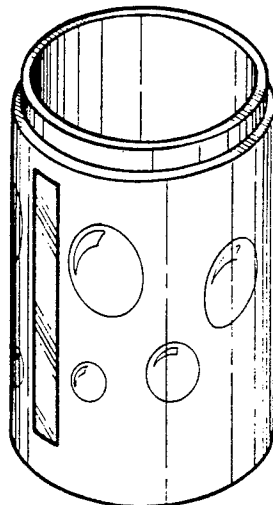
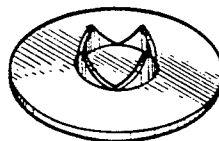
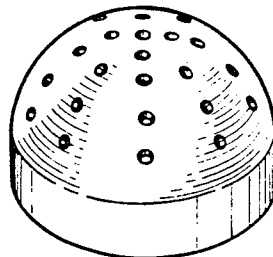

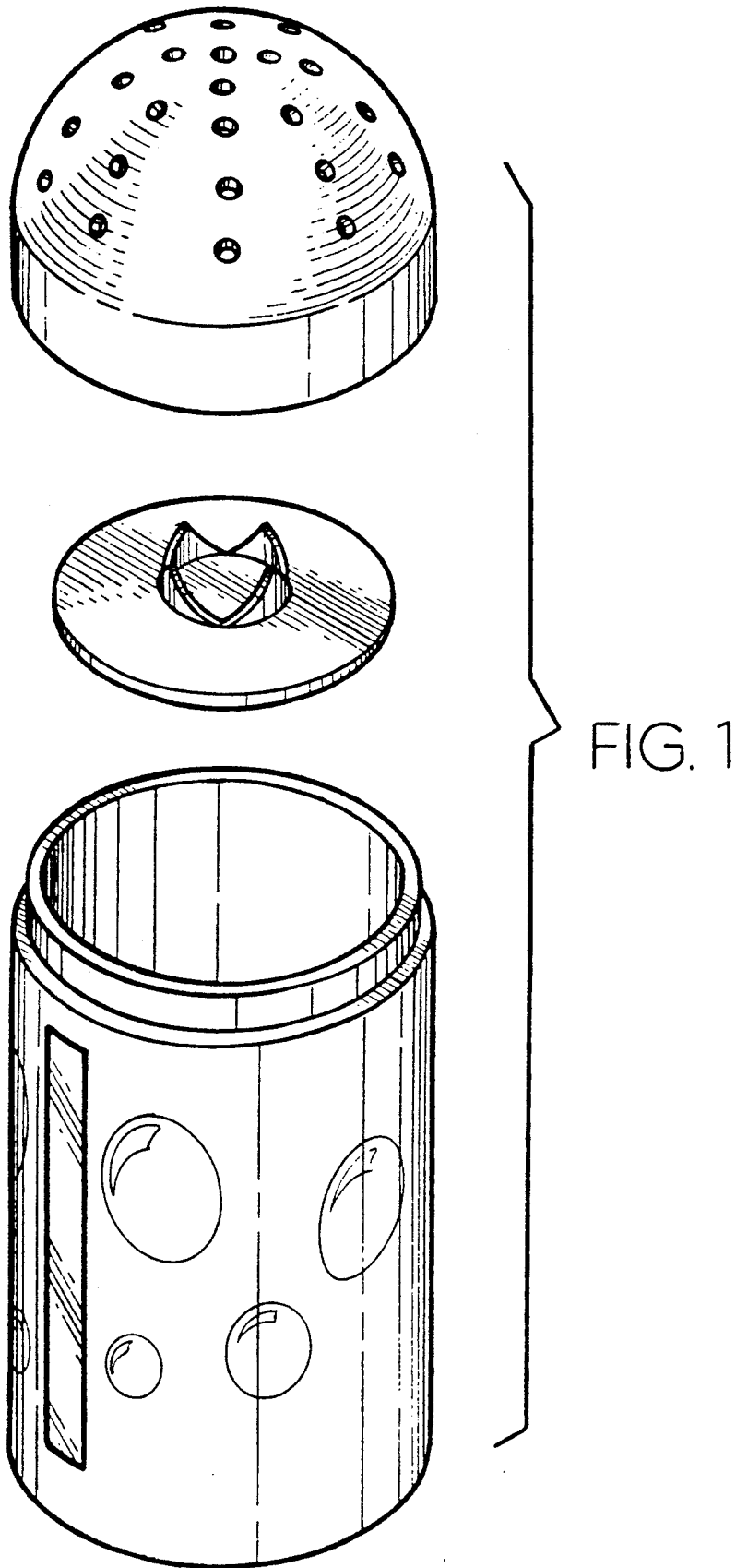

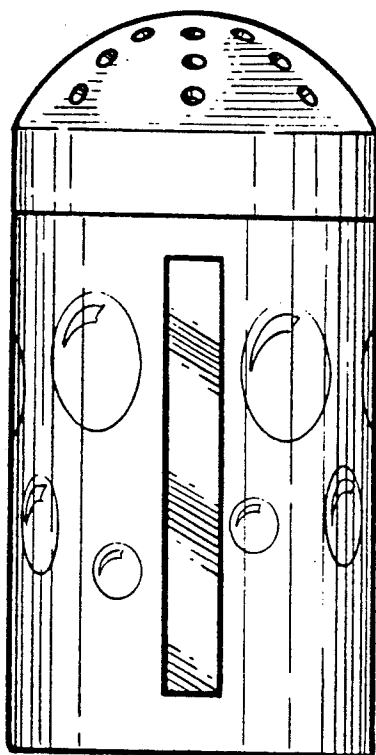

FIG. 2

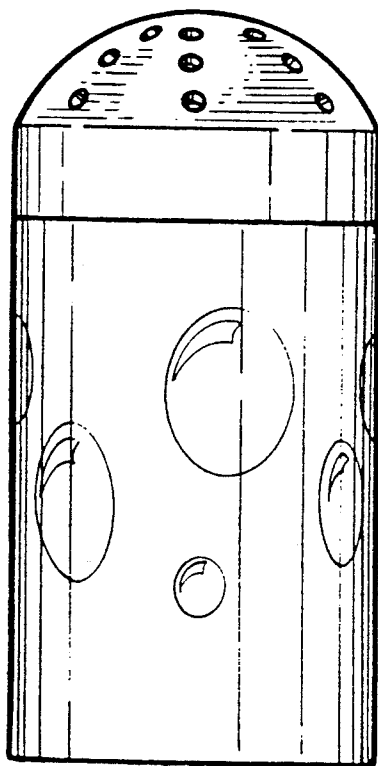

FIG. 3

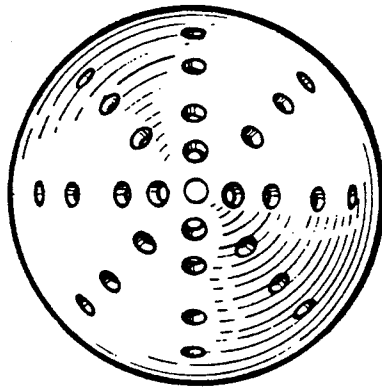

FIG. 4

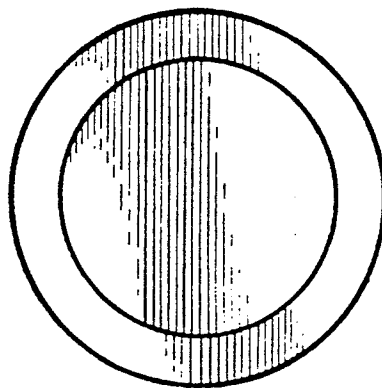

FIG. 5