



US0D1021687S

(12) **United States Design Patent**  
**Chan**

(10) **Patent No.:** **US D1,021,687 S**

(45) **Date of Patent:** **\*\* Apr. 9, 2024**

- (54) **BUCKLE**
- (71) Applicant: **Duraflex Hong Kong Limited**, Hong Kong (CN)
- (72) Inventor: **Man Chak Chan**, Hong Kong (CN)
- (73) Assignee: **DURAFLEX HONG KONG LIMITED**, Hong Kong (HK)

- D274,861 S \* 7/1984 Lindblad ..... D11/216
- D302,140 S \* 7/1989 Johnston ..... D11/216
- D327,455 S \* 6/1992 Blair ..... D11/216
- D333,640 S \* 3/1993 Keller ..... D11/216
- D362,414 S \* 9/1995 Takimoto ..... D11/216
- D368,239 S \* 3/1996 Lozano ..... D11/216
- D483,691 S \* 12/2003 Uehara ..... D11/216
- D628,514 S \* 12/2010 Paik ..... D11/216

(Continued)

- (\*\*) Term: **15 Years**
- (21) Appl. No.: **29/748,311**

**FOREIGN PATENT DOCUMENTS**

CN 306030153 \* 9/2020

- (22) Filed: **Aug. 28, 2020**

**OTHER PUBLICATIONS**

Elastic Stretch Belt with Adjustable Buckle, Date Available Sep. 13, 2017, Amazon, Site Visited on Nov. 13, 2023: <https://www.amazon.com/Elastic-Stretch-Adjustable-Buckle-X-Small/dp/B07GZ545C5/> (Year: 2017).\*

(30) **Foreign Application Priority Data**

May 12, 2020 (CN) ..... 202030213413.4

(Continued)

- (51) **LOC (14) Cl.** ..... **02-07**

- (52) **U.S. Cl.** ..... **D11/218**  
USPC ..... **D11/218**

*Primary Examiner* — Gino Colan  
*Assistant Examiner* — Nicole M. Leech  
(74) *Attorney, Agent, or Firm* — IPRO, PLLC

- (58) **Field of Classification Search**  
USPC ..... D11/200, 206, 208, 215, 216, 218, 220;  
D8/382, 383; D2/627, 639; D3/215;  
D29/100-101.5, 122; D30/139, 151-152,  
D30/199  
CPC ..... A44B 11/00; A44B 11/006; A44B 11/06;  
A44B 11/16; A44B 11/25; A44B 11/2503;  
A44B 11/2526; A44B 11/253; A44B  
11/2549; A44B 11/2569; A44B 11/258;  
A44B 11/2584; A44B 11/2588; A44B  
11/28; A62B 35/00; A62B 35/0006; A62B  
35/0025; A62B 35/0031  
See application file for complete search history.

- (57) **CLAIM**  
The ornamental design for a buckle, as shown and described.

(56) **References Cited**

**U.S. PATENT DOCUMENTS**

- D171,045 S \* 12/1953 Noe ..... D11/216
- 2,888,724 A \* 6/1959 Anderson ..... A44B 11/2526  
24/191

**DESCRIPTION**

FIG. 1 is a front elevation view of a buckle showing my new design;  
FIG. 2 is a rear elevation view thereof;  
FIG. 3 is a left side elevation view thereof;  
FIG. 4 is a right side elevation view thereof;  
FIG. 5 is a top plan view thereof;  
FIG. 6 is a bottom plan view thereof;  
FIG. 7 is a perspective view thereof; and,  
FIG. 8 is another perspective view thereof.  
The broken lines in the drawings illustrate portions of the buckle that form no part of the claimed design.

**1 Claim, 8 Drawing Sheets**

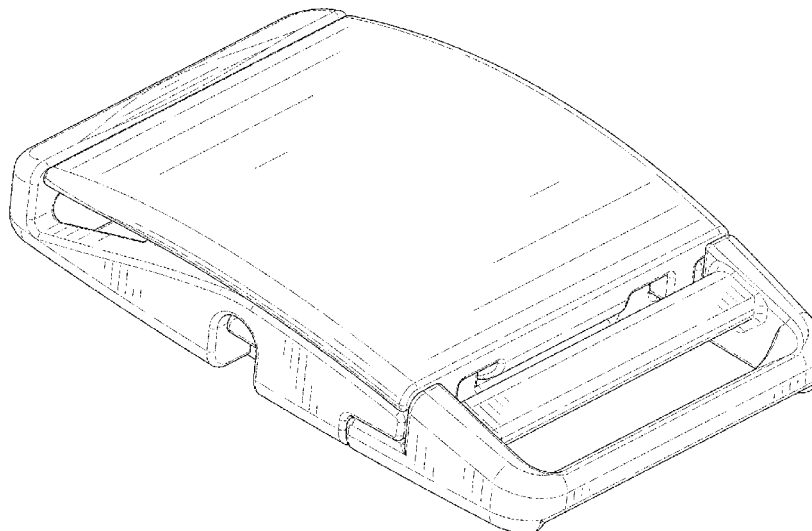

(56)

**References Cited**

U.S. PATENT DOCUMENTS

D703,581 S \* 4/2014 Kellegan ..... D11/216  
D714,682 S \* 10/2014 Paik ..... D11/216  
D742,786 S \* 11/2015 Kung ..... D11/216  
D873,172 S \* 1/2020 Hansson ..... D11/216  
D934,114 S \* 10/2021 Karvandi ..... D11/216  
2009/0094809 A1\* 4/2009 Kung ..... A44B 11/25  
24/625  
2020/0154804 A1\* 5/2020 Huang ..... A44B 11/28  
2023/0073144 A1\* 3/2023 Chan ..... A44B 11/2592

OTHER PUBLICATIONS

Plastic Web Belt Buckle Rothco, Date Available May 3, 2019, Ebay,  
Site Visited on Nov. 13, 2023: <https://www.ebay.com/itm/264050117874> (Year: 2019).\*

Neo Single Adj. Belt Buckle, No Date Available, Duraflex Group,  
Site Visited on Nov. 13, 2023 <https://www.duraflexgroup.com/products/PROF00003142/> (Year: 2023).\*

\* cited by examiner

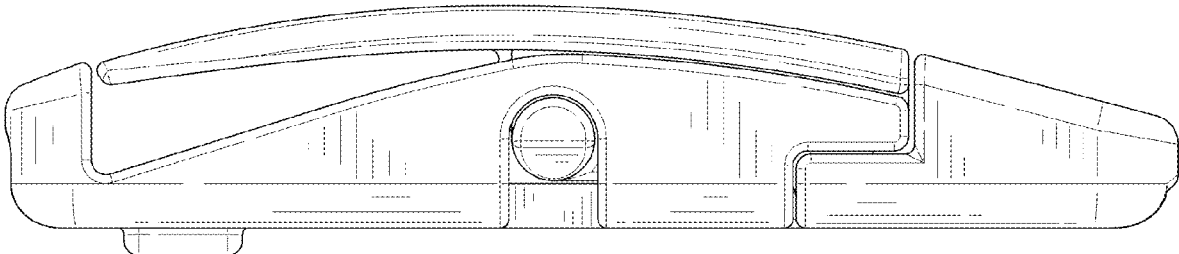

FIG. 1

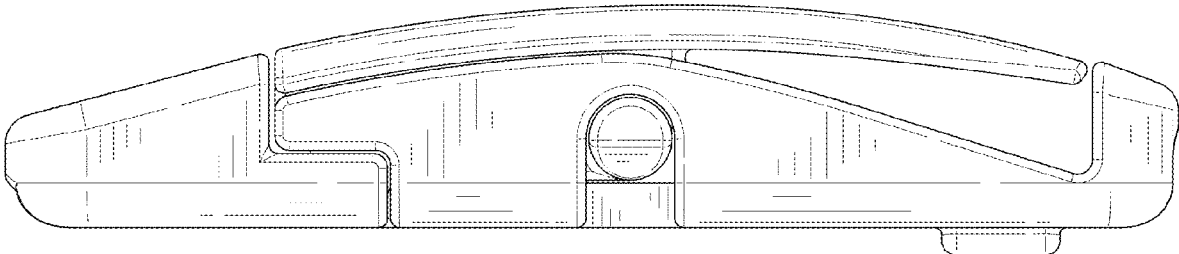

FIG. 2

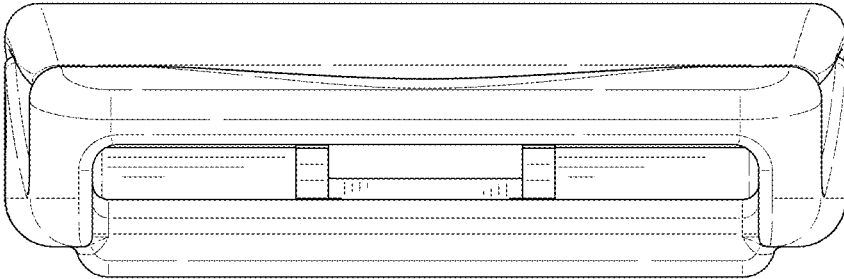

FIG. 3

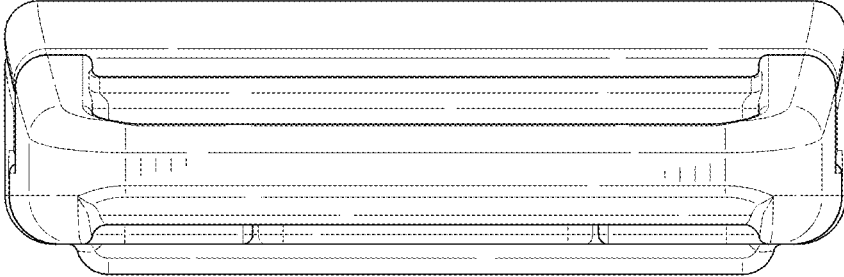

FIG. 4

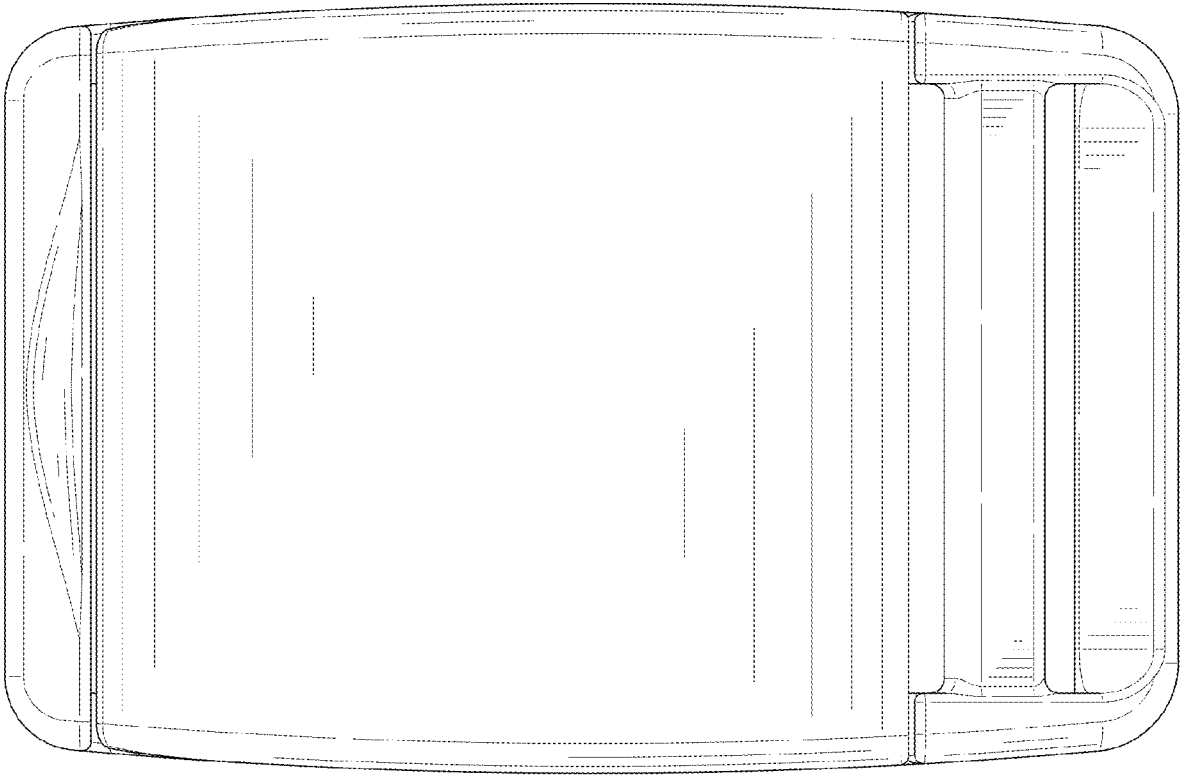

FIG. 5

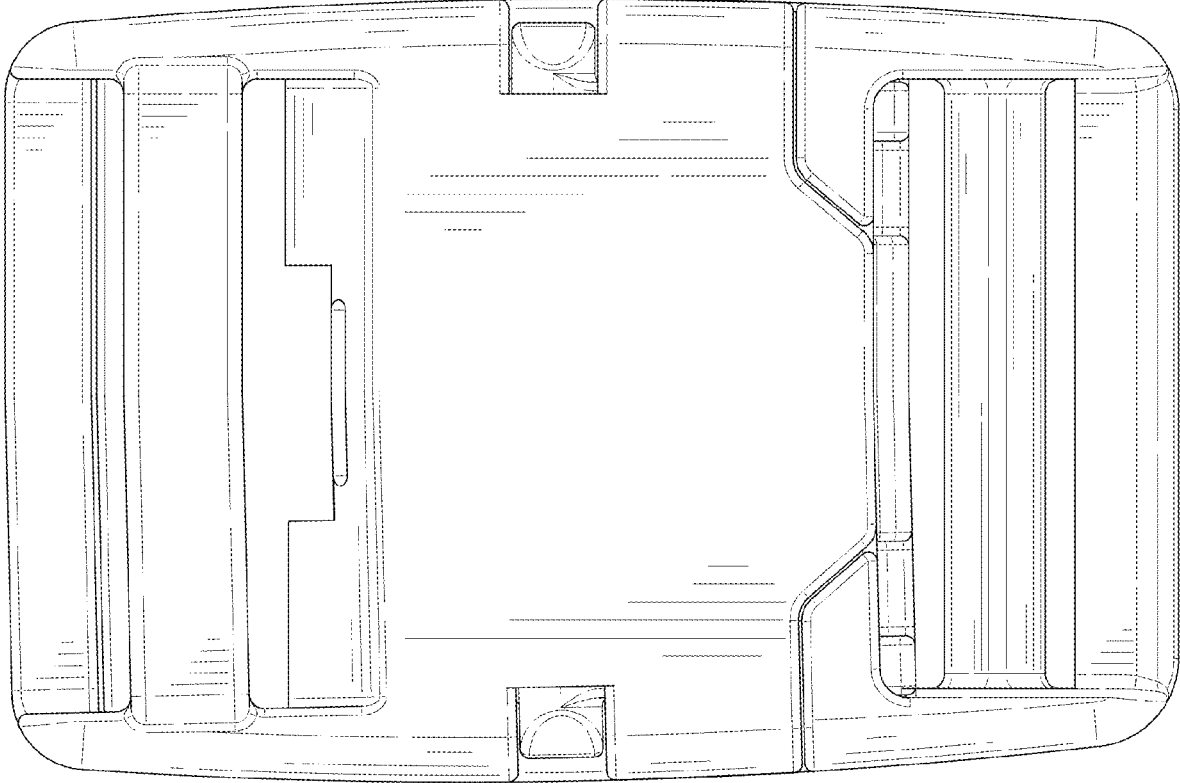

FIG. 6



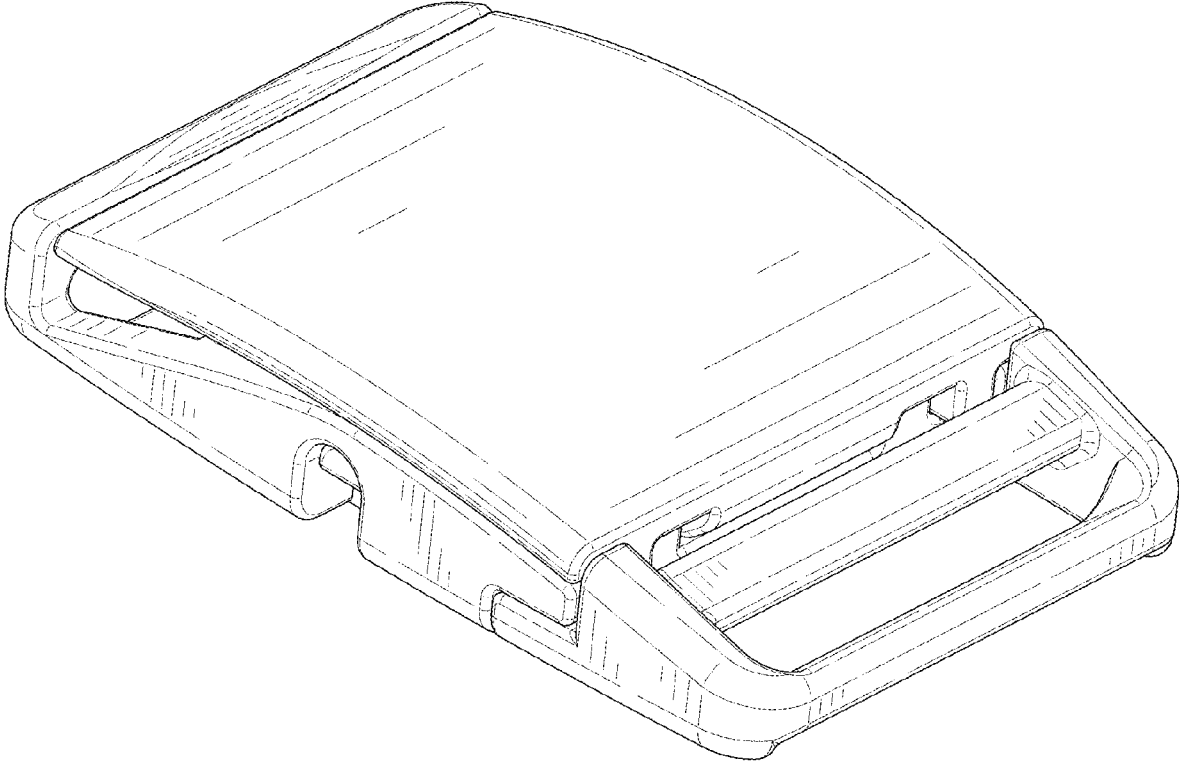

FIG. 7

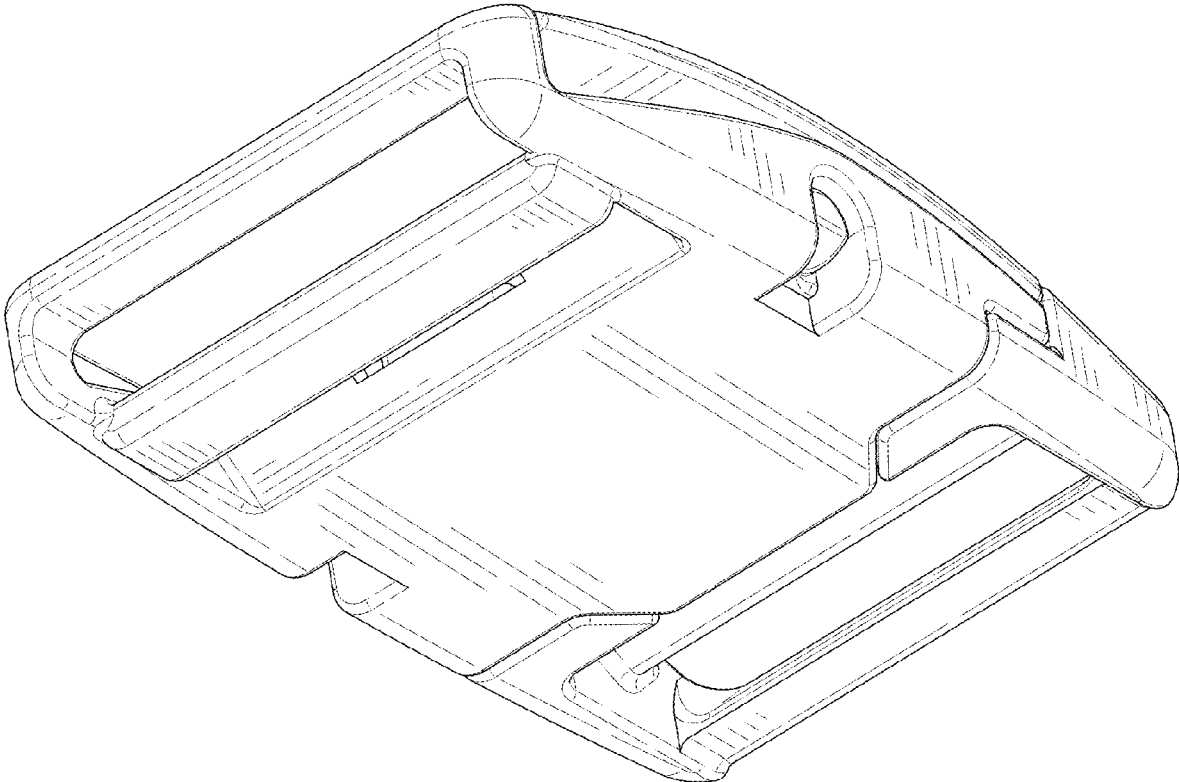

FIG. 8