



US00D993491S

(12) **United States Design Patent**
Hoover et al.

(10) **Patent No.:** **US D993,491 S**

(45) **Date of Patent:** **** Jul. 25, 2023**

(54) **LIGHT FIXTURE**

- (71) Applicant: **Kohler Co.**, Kohler, WI (US)
- (72) Inventors: **Erin Leigh Hoover**, NY, NY (US);
Nicholas Robert Rindt, Grafton, WI (US); **Dennis Lee Snyder**, Sheboygan, WI (US); **Seth M. Stevens**, Los Angeles, CA (US); **Maxwell Wasscher**, Grafton, WI (US); **Luke James Worth**, Sheboygan, WI (US); **Jovello Tijano Gomez, Jr.**, Sheboygan, WI (US)
- (73) Assignee: **KOHLER CO.**

- (**) Term: **15 Years**
- (21) Appl. No.: **29/745,513**
- (22) Filed: **Aug. 6, 2020**

Related U.S. Application Data

- (62) Division of application No. 29/744,909, filed on Jul. 31, 2020.
- (51) **LOC (14) Cl.** **26-03**
- (52) **U.S. Cl.**
USPC **D26/88; D26/135**
- (58) **Field of Classification Search**
USPC D26/72, 81, 82, 85, 86, 87, 88, 92, 135
CPC .. F21S 8/033; F21S 8/036; F21S 8/043; F21S 8/046; F21S 8/06; F21S 8/061; F21S 8/063; F21S 8/065
See application file for complete search history.

(56) **References Cited**

U.S. PATENT DOCUMENTS

- D48,158 S 11/1915 Morell
 - D304,768 S * 11/1989 Dicola D26/84
 - D320,461 S 10/1991 Pagani
- (Continued)

OTHER PUBLICATIONS

Warehouse 2-light Stem Hung Pendant Light, Model No. 12131MSD182-50-T48-W12. Available at southernlightsinc.com. Site visited Mar. 30, 2023. (Year: 2023).*

(Continued)

Primary Examiner — Clare E Heflin
(74) *Attorney, Agent, or Firm* — The Belles Group, P.C.

(57) **CLAIM**

We claim the ornamental design for a light fixture, as shown and described.

DESCRIPTION

FIG. 1 is a perspective view of an embodiment of the claimed design;
FIG. 2 is a front view of the claimed design shown in FIG. 1;
FIG. 3 is a rear view of the claimed design shown in FIG. 1;
FIG. 4 is a side view of the claimed design shown in FIG. 1;
FIG. 5 is another side view of the claimed design shown in FIG. 1;
FIG. 6 is a top view of the claimed design shown in FIG. 1; and,
FIG. 7 is a bottom view of the claimed design shown in FIG. 1.

The ornamental design that is claimed is shown in the drawings as solid lines and surfaces having surface shading. The broken lines in the drawings are for illustrative purposes only and form no part of the claimed design. For example, broken lines formed by equal length dashes show unclaimed portions of the design. Break lines having a jagged element are not part of the claimed design and show unspecified lengths of the portion are possible. The appearance of any portion of the article between the break lines forms no part of the claimed design.

1 Claim, 5 Drawing Sheets

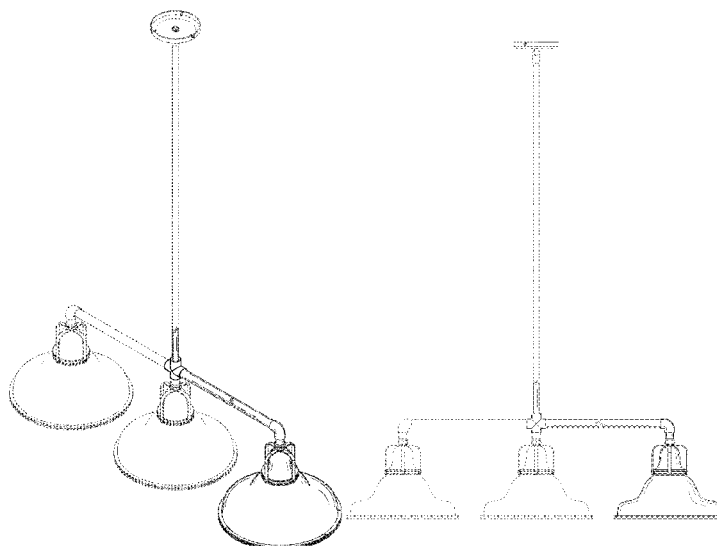

(56)

References Cited

OTHER PUBLICATIONS

U.S. PATENT DOCUMENTS

D330,947 S *	11/1992	Donato	D26/85
D333,011 S	2/1993	Ewing	
5,406,466 A	4/1995	Stokes	
D368,974 S	4/1996	Belisle	
D404,168 S	1/1999	Dolan	
D425,236 S	5/2000	Porter	
D436,418 S	1/2001	Porter	
D461,580 S	8/2002	Hsu	
D467,677 S	12/2002	Ries	
D588,298 S	3/2009	Sabernig	
D588,299 S	3/2009	Sabernig	
D592,792 S	5/2009	Keller	
7,988,327 B1	8/2011	Knoble et al.	
D667,161 S	9/2012	Chen	
D713,590 S	9/2014	Orozco	
D803,460 S	11/2017	Engle	
D829,360 S	9/2018	Mou	
D829,361 S *	9/2018	Deng	D26/88
D869,734 S *	12/2019	Babutzka	D26/88
D882,149 S	4/2020	Lin	
D888,319 S	6/2020	Amato	
11,304,274 B1	4/2022	Fu et al.	
D959,042 S *	7/2022	Orozco	D26/88
D959,724 S	8/2022	Hoover	
D966,595 S	10/2022	Rindt	
D970,085 S	11/2022	Hoover	
11,536,420 B1	12/2022	Glazer et al.	

Dino 2-Light Stem Mount Pendant Light. Available at barnlight.com as early as Jul. 5, 2015. (Year: 2015).*

Hauksbee 3-Light Pendant with Metal Shade, Model No. Model #K-32290-PE03-WCL. Available at homedepot.com as early as May 1, 2021. (Year: 2021).*

Quoizel Grant Mini Pendant Ceiling Lighting, 1-Light, Model No. GRIS2814PN. ASIN: B07MJD1D25. Date first available at amazon.com—Jan. 8, 2019. (Year: 2019).*

Goalplus—Gooseneck Barn Light Fixture, ASIN: B07WFDZW5Y. Available from amazon.com Aug. 13, 2019. (Year: 2019).

Progress Lighting—Outdoor Barn Light, Model No. P5623-20. ASIN: B01AISHHCC. Available from amazon.com Jan. 12, 2016. (Year: 2016).

Designers Fountain—Bayport Outdoor Wall Sconce, model No. 31331-BZ. ASI N: BOOEHFQOXK available from amazon.com Mar. 21, 2009. (Year: 2009).

Hinkley—Troyer Collection One Light Outdoor Wall Fixture. ASIN: B073X6J HML available from amazon.com Jul. 22, 2017. (Year: 2017).

Golden Lighting Duncan Single Light 9" Tall Bathroom Sconce, Model: 3602-BA1 PW-SF Available from build.com as early as Mar. 18, 2019. (Year: 2019).

Hinkley Lighting Rowan 1 Light 8" Tall Bathroom Sconce with Polished White Metal Shade, Model:5810CM. Available from build.com as early as Mar. 18, 2021. (Year: 2021).

Progress Lighting Archie Wall Sconce, Model No. P2989-74 Spec Sheet dated Oct. 2015. From progresslighting.com (Year: 2015).

* cited by examiner

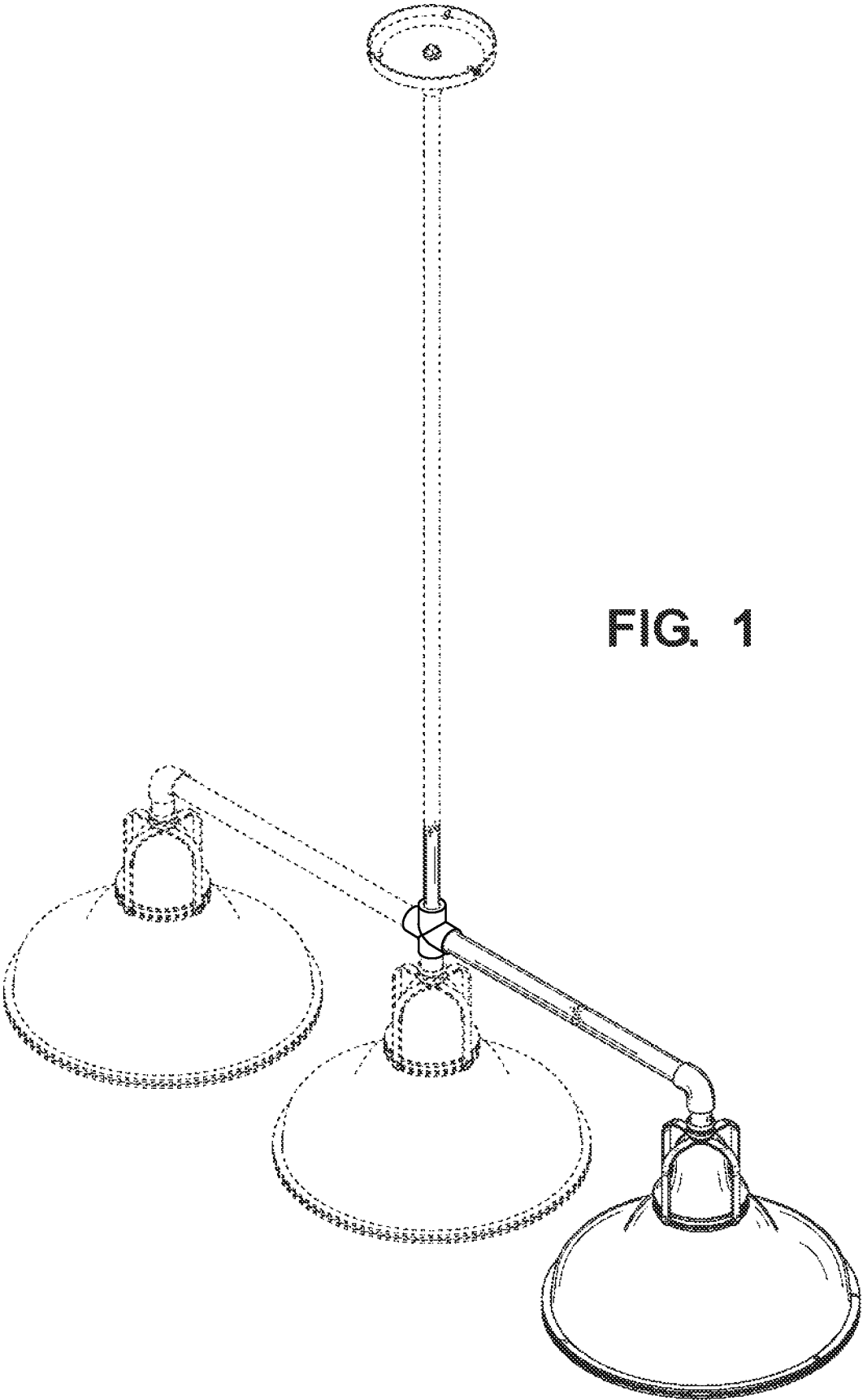

FIG. 1

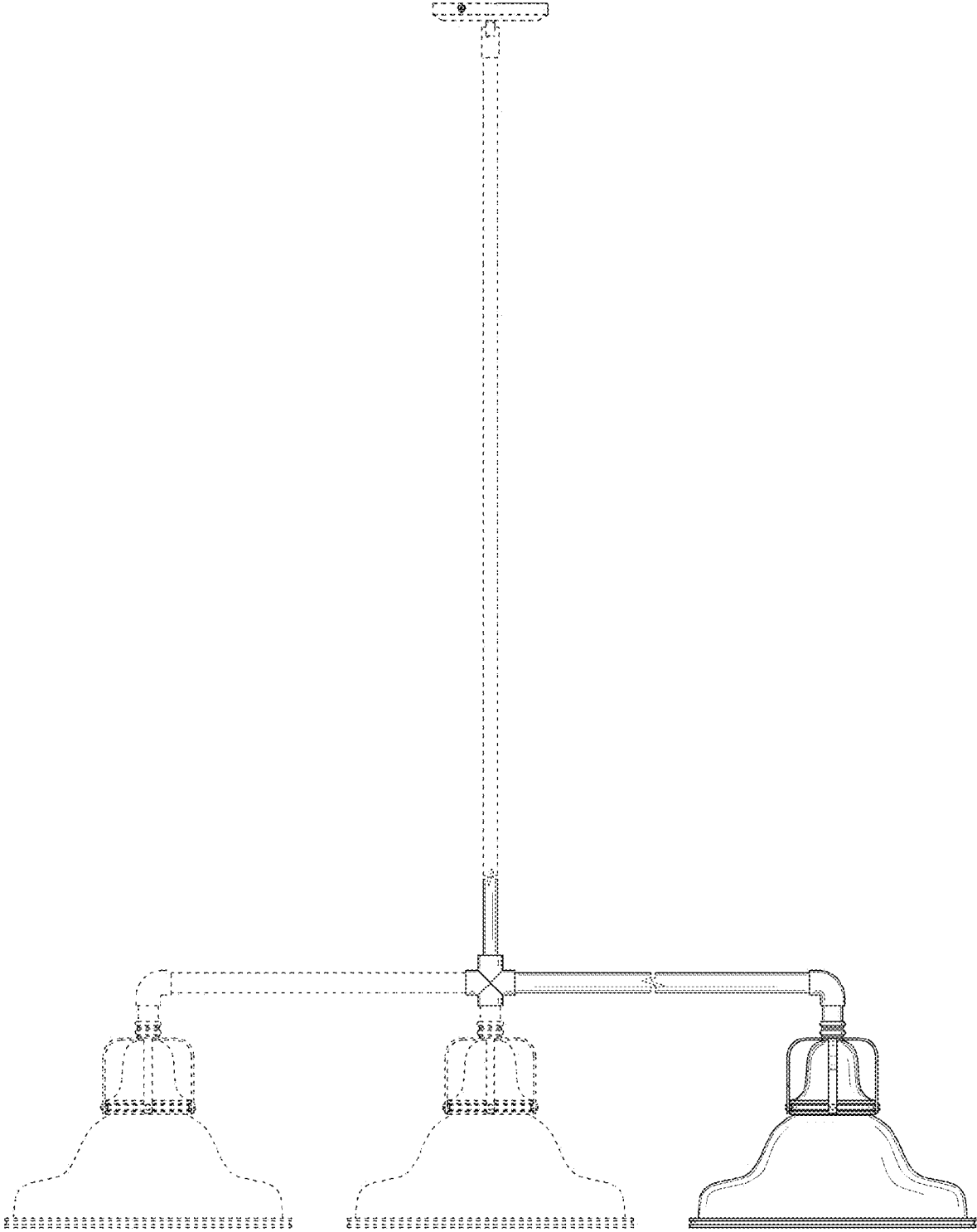

FIG. 2

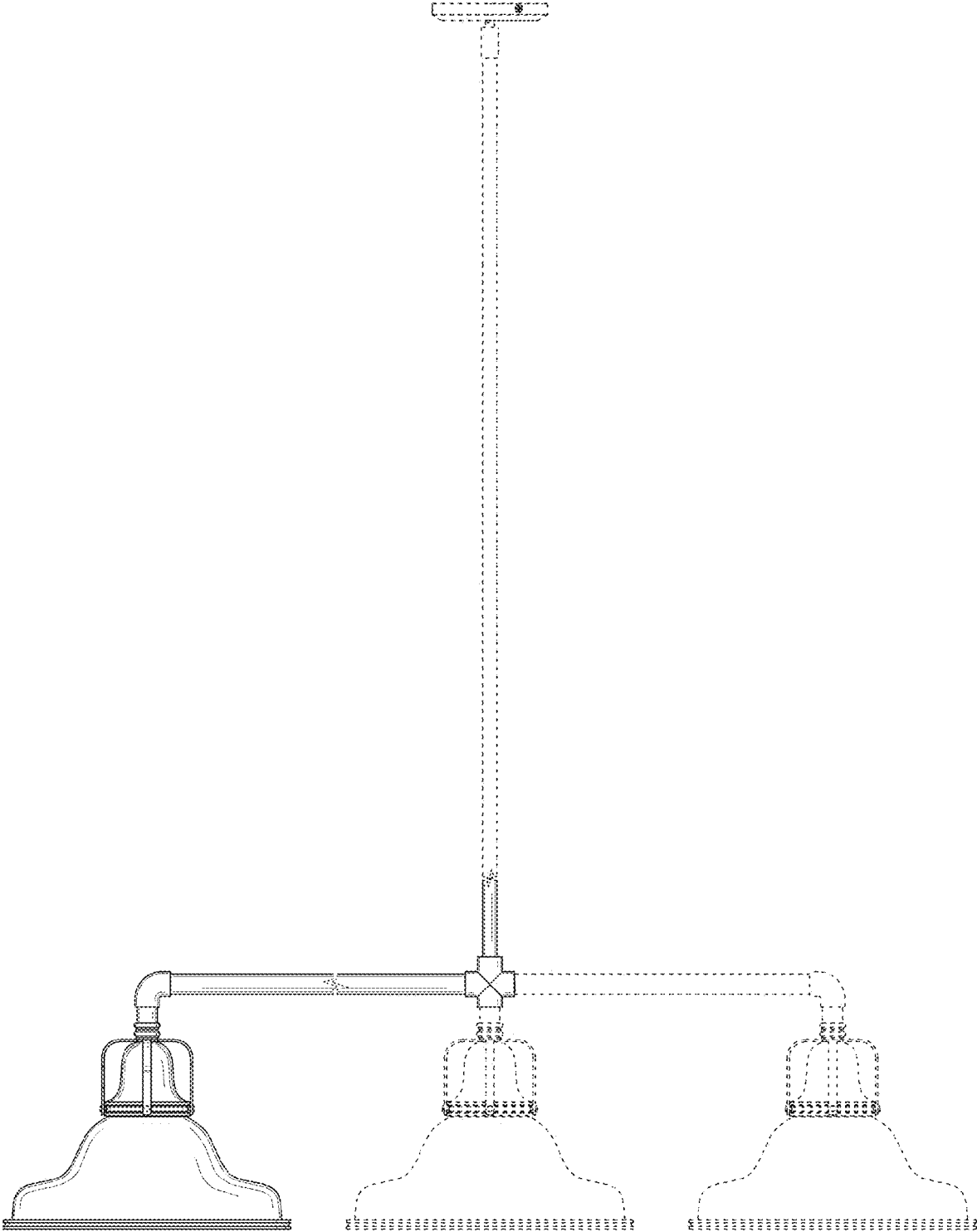

FIG. 3

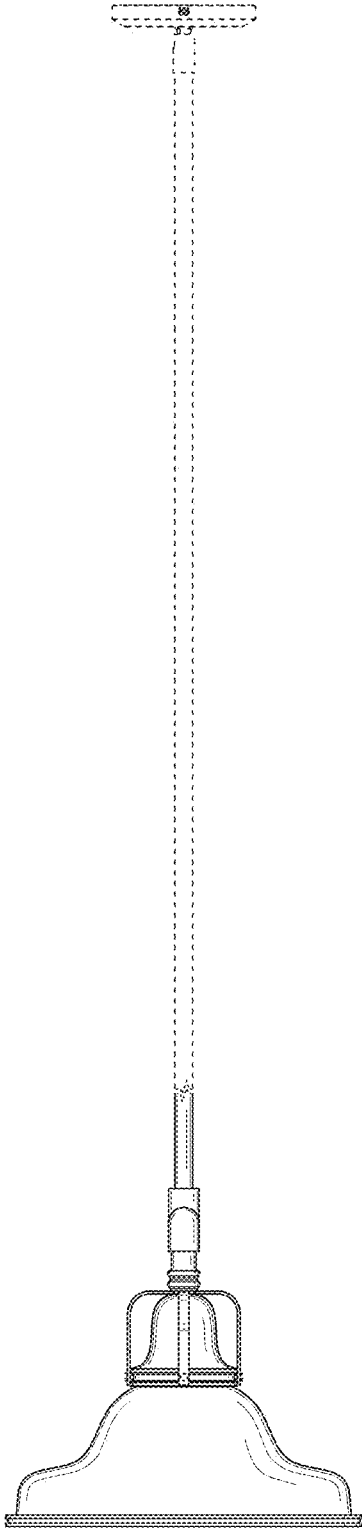

FIG. 4

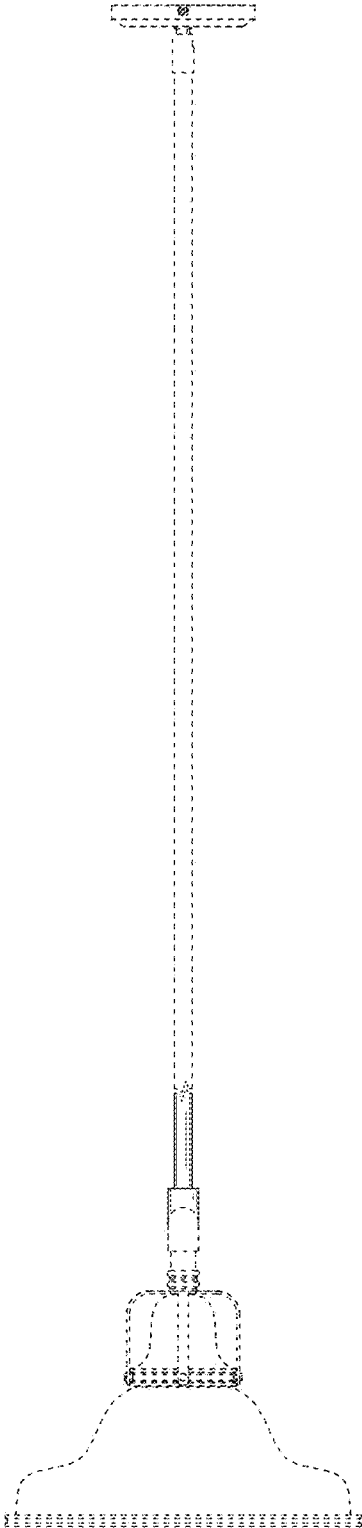

FIG. 5

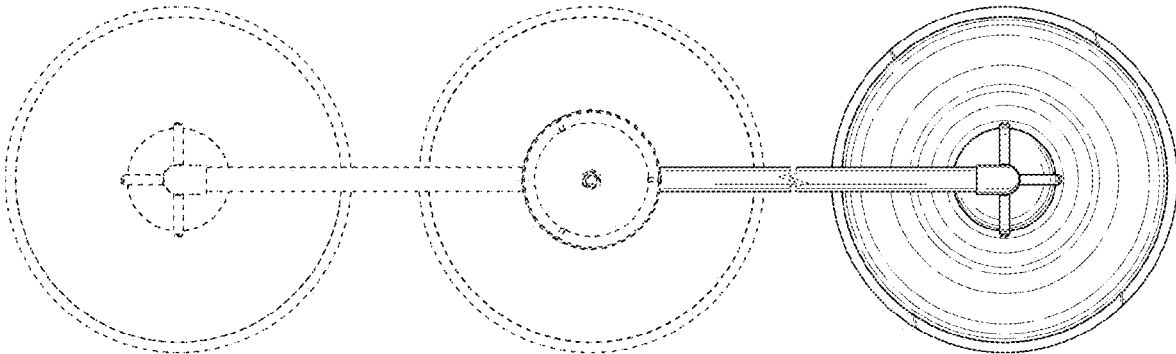

FIG. 6

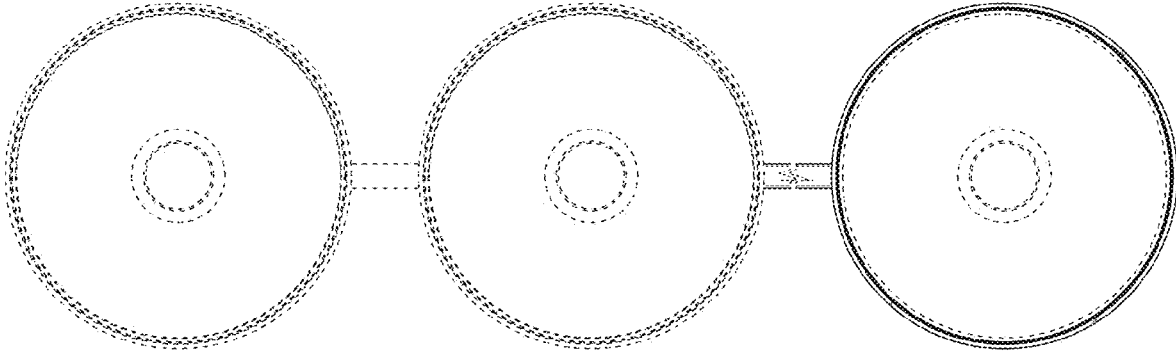

FIG. 7