



US0D1041214S

(12) **United States Design Patent**
Duhadway

(10) **Patent No.:** **US D1,041,214 S**

(45) **Date of Patent:** **** Sep. 10, 2024**

(54) **DRESSER**

OTHER PUBLICATIONS

(71) Applicant: **WALKER EDISON FURNITURE COMPANY LLC**, West Jordan, UT (US)

Middlebrook, posted Dec. 5, 2021 [online], [retrieved Jun. 23, 2023]. Retrieved from internet, [https://www.overstock.com/Home-Garden/The-Gray-Barn-6-Drawer-Farmhouse-Dresser/33128229/product.html?refccid=Z\(Date: 2023\) \(Year: 2021\).*](https://www.overstock.com/Home-Garden/The-Gray-Barn-6-Drawer-Farmhouse-Dresser/33128229/product.html?refccid=Z(Date: 2023) (Year: 2021).*)

(72) Inventor: **Tiffany Duhadway**, Salt Lake City, UT (US)

(Continued)

(73) Assignee: **Walker Edison Furniture Company LLC**, West Jordan, UT (US)

Primary Examiner — Christian P. McLean
Assistant Examiner — Kristopher Michael Blechschmidt
(74) *Attorney, Agent, or Firm* — Workman Nydegger

(**) Term: **15 Years**

(57) **CLAIM**

(21) Appl. No.: **29/824,076**

The ornamental design for a dresser, as shown and described.

(22) Filed: **Jan. 21, 2022**

(51) **LOC (14) Cl.** **06-04**

(52) **U.S. Cl.**
USPC **D6/671.1**

(58) **Field of Classification Search**
USPC D6/671, 671.1, 672, 663, 698, 668.2,
D6/675, 654.18, 675.2
CPC A47B 67/04; A47B 2210/0059; A47B
2230/0011; A47B 43/02; A47B 47/03;
A47B 47/04; A47B 47/045; A47B 61/00;
A47B 61/06; A47B 63/00; A47B 67/005;
A47B 83/00; A47B 87/0207; A47B
88/407;

DESCRIPTION

FIG. 1 is a front perspective view of a first embodiment of a dresser showing the new design;
FIG. 2 is a front elevation view thereof;
FIG. 3 is a back elevation view thereof;
FIG. 4 is a top plan view thereof;
FIG. 5 is a bottom plan view thereof;
FIG. 6 is a left elevation view thereof;
FIG. 7 is a right elevation view thereof;
FIG. 8 is another front perspective view thereof showing drawers thereof in open configurations;
FIG. 9 is a front perspective view of second embodiment thereof;
FIG. 10 is a front elevation view thereof;
FIG. 11 is a back elevation view thereof;
FIG. 12 is a top plan view thereof;
FIG. 13 is a bottom plan view thereof;
FIG. 14 is a left elevation view thereof;
FIG. 15 is a right elevation view thereof; and,
FIG. 16 is another front perspective view thereof showing drawers thereof in open configurations.
The broken lines shown in the figures illustrate portions of the dresser that form no part of the claimed design.

(Continued)

(56) **References Cited**

U.S. PATENT DOCUMENTS

245,925 A 8/1881 Kinsley
309,799 A 12/1884 Poulson
D47,600 S 7/1915 Koch

(Continued)

FOREIGN PATENT DOCUMENTS

CA 188835 S 1/2021
CA 188838 S 1/2021

(Continued)

1 Claim, 10 Drawing Sheets

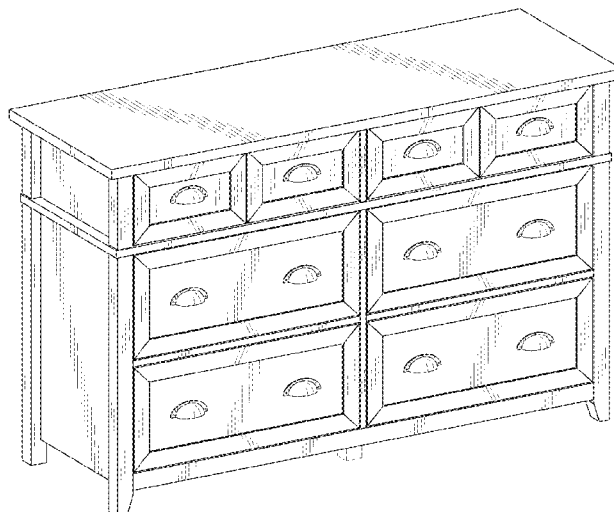

(58) **Field of Classification Search**
 CPC A47B 88/43; A47B 67/00; A47B 69/00;
 A47B 77/00; A47B 79/00; A47B 96/00
 See application file for complete search history.

(56) **References Cited**

U.S. PATENT DOCUMENTS

D59,617 S	11/1921	Beach	D238,277 S	12/1975	Zaitlin
D61,344 S	8/1922	Mayer	D239,352 S	3/1976	Petrick
1,475,088 A	11/1923	Specht	D240,685 S	7/1976	Eisen
D64,390 S	4/1924	Arons	3,971,608 A	7/1976	Gans
D64,922 S	6/1924	Naill	D241,293 S	9/1976	Introini
D66,028 S	11/1924	Lyons	D248,429 S	7/1978	Inohara
D66,889 S	3/1925	Schleiche	D249,429 S	9/1978	Robinson
D68,065 S	8/1925	Schleiche	D249,860 S	10/1978	Ungaro
D68,659 S	11/1925	Smith	D251,885 S	5/1979	Tebbe
D78,127 S	3/1929	Schleicher	4,182,244 A	1/1980	Gebhardt et al.
D90,370 S	7/1933	McClure	D259,316 S	5/1981	Offredi
D97,309 S	10/1935	Stoltz	D262,847 S	2/1982	Keller
D98,366 S	1/1936	Pumphrey	D267,377 S	12/1982	Mower et al.
D106,296 S	10/1937	Krick	D269,754 S	7/1983	Kates
D106,299 S	10/1937	Krick	D270,858 S	10/1983	McInnes
D116,245 S	8/1939	Shurcliff	4,491,226 A	1/1985	Marschak
D120,370 S	5/1940	Bach	D281,901 S	12/1985	Demrick et al.
2,207,307 A	7/1940	Jacob et al.	D283,343 S	4/1986	Haythornthwaite
D129,484 S	9/1941	Jiranek	D286,959 S	12/1986	Doezema
D129,585 S	9/1941	Jiranek	D290,913 S	7/1987	Righter
D149,434 S	4/1948	Moberg	D296,505 S	7/1988	Kaliski
D149,763 S	5/1948	Ketchum, Jr. et al.	D301,413 S	6/1989	Rosen
D159,488 S	8/1950	Jiranek	D303,596 S	9/1989	Goetz
D164,614 S	9/1951	Wallace	D304,982 S	12/1989	Bush et al.
D165,241 S	11/1951	Porter	D305,930 S	2/1990	MacAleese
D165,242 S	11/1951	Porter	4,930,643 A	6/1990	Flum
D165,243 S	11/1951	Porter	4,953,362 A	9/1990	Shoji et al.
D165,397 S	12/1951	Robbins	D312,738 S	12/1990	Newhouse
D166,077 S	3/1952	Haas	D314,092 S	1/1991	Bush et al.
D167,392 S	8/1952	Carr	D314,093 S	1/1991	Bush et al.
D167,770 S	9/1952	Porter	D314,094 S	1/1991	Bush et al.
D168,603 S	1/1953	Tell	D319,230 S	8/1991	Sugiyama
D168,840 S	2/1953	Herman	5,036,778 A	8/1991	Briosi
D170,856 S	11/1953	Gershun	D319,743 S	9/1991	Grey
D175,869 S	10/1955	Trout et al.	D327,735 S	7/1992	Smith et al.
D176,404 S	12/1955	Carr	D328,341 S	7/1992	Chiu
D177,159 S	3/1956	Van Koert	D328,830 S	8/1992	Allen
2,743,720 A	5/1956	Dollinger	D329,693 S	9/1992	Mills
D178,054 S	6/1956	Hermann	D336,184 S	6/1993	Borgen
D182,832 S	5/1958	Lubberts	D336,392 S	6/1993	Whalen
D182,836 S	5/1958	Lubberts et al.	D347,754 S	6/1994	Mehlin
D182,838 S	5/1958	John et al.	D348,363 S	7/1994	Willemsen
D183,923 S	11/1958	Naylor	D348,574 S	7/1994	Brunner
D184,935 S	4/1959	Herrmann	D348,576 S	7/1994	Narramore
D186,115 S	9/1959	Church	D348,726 S	7/1994	Wilson
2,918,176 A	12/1959	Bell et al.	D350,042 S	8/1994	Sheperd
D187,232 S	2/1960	Matyas	D353,282 S	12/1994	Keller
D188,196 S	6/1960	Lubberts et al.	D353,960 S	1/1995	Barfield
D188,197 S	6/1960	Swarts et al.	5,409,122 A	4/1995	Lazarus
D189,040 S	10/1960	Knudsen	5,452,812 A	9/1995	Niequist et al.
3,039,621 A	6/1962	Pilcher	D363,841 S	11/1995	Nourse
D193,516 S	9/1962	Deaton	D364,055 S	11/1995	Pakla
D193,717 S	10/1962	Deaton	5,463,966 A	11/1995	Nilsson
3,063,252 A	11/1962	Lamb	D365,226 S	12/1995	Goebel
D196,451 S	10/1963	McMullen	D365,472 S	12/1995	Rehnberg
3,180,972 A	4/1965	Covault	D366,110 S	1/1996	Darr
3,217,671 A	11/1965	Walsh	D367,383 S	2/1996	Hatrack-Smith
D203,194 S	12/1965	Klein	D368,392 S	4/1996	Brunner et al.
D205,290 S	7/1966	Klein	D368,604 S	4/1996	Gotham
3,272,582 A	9/1966	Anderson et al.	D370,365 S	6/1996	Brunner et al.
3,354,878 A	11/1967	Balls	D370,572 S	6/1996	Lin
3,589,746 A	6/1971	Inglis et al.	D373,693 S	9/1996	Elhage
RE27,186 E	10/1971	Ferdinand	D374,784 S	10/1996	Brunner et al.
RE27,200 E	10/1971	Ferdinand et al.	D376,494 S	12/1996	Brunner et al.
D225,954 S	1/1973	Schachel	5,628,256 A	5/1997	Lazarus
3,762,789 A	10/1973	Robertson	D379,880 S	6/1997	Stoeckli
3,766,863 A	10/1973	Swick et al.	D383,014 S	9/1997	Sagol
D233,294 S	10/1974	Goulder et al.	D384,525 S	10/1997	McBrayer
D236,676 S	9/1975	Urti	D385,431 S	10/1997	Lee
			D386,019 S	11/1997	Grosfillex
			5,685,238 A	11/1997	Chambers
			5,695,081 A	12/1997	Alkalay
			D388,634 S	1/1998	Mulligan
			D389,343 S	1/1998	Van et al.
			D390,936 S	2/1998	French et al.
			D394,171 S	5/1998	De Blaay
			5,752,500 A	5/1998	Jamieson et al.
			5,782,231 A	7/1998	Wade
			D396,577 S	8/1998	Zaidman

* 10/1996 Brunner et al. D6/671.1

(56)

References Cited

U.S. PATENT DOCUMENTS

D398,186 S	9/1998	Zaidman	
D401,443 S *	11/1998	Zaidman	D6/671.1
5,833,084 A	11/1998	Chang	
D403,529 S	1/1999	De Blaay	
D404,937 S	2/1999	Tarlow	
D405,768 S	2/1999	O'Sullivan	
D406,705 S	3/1999	Zaidman	
D407,238 S	3/1999	Zaidman	
D407,577 S	4/1999	Dorst	
D408,169 S	4/1999	Welbom	
D408,174 S	4/1999	Aspenwall	
D416,720 S	11/1999	Draheim et al.	
D420,114 S	2/2000	Johnson	
D423,810 S	5/2000	Dorst	
D425,330 S	5/2000	O'Hare	
D427,453 S	7/2000	Lacroix et al.	
D427,806 S	7/2000	Lacroix et al.	
D428,609 S	7/2000	Williams	
D430,431 S	9/2000	Walter	
D431,393 S *	10/2000	Walters, III	D6/671.1
D431,934 S	10/2000	Chinnis	
D436,754 S	1/2001	Bellini	
D439,777 S	4/2001	Laughton	
D440,071 S	4/2001	Hutton	
D440,073 S	4/2001	Cain	
D440,074 S	4/2001	Hutton	
D440,427 S	4/2001	Melilo	
D440,430 S	4/2001	Hutton	
D440,789 S	4/2001	Tabbia	
D442,801 S	5/2001	Hutton	
D443,155 S	6/2001	Hutton	
D444,002 S	6/2001	Hutton	
D445,596 S	7/2001	Stout et al.	
D448,203 S	9/2001	Jeup	
D449,465 S *	10/2001	Tabbia	D6/671.1
D450,488 S	11/2001	Stone et al.	
D452,624 S	1/2002	De Blois	
D454,264 S	3/2002	Patik	
D455,916 S	4/2002	Fluhrer et al.	
D456,179 S	4/2002	Ferrer Beltran	
6,393,207 B1	5/2002	Martin et al.	
D459,111 S *	6/2002	Tobin, Jr.	D6/671.1
D462,008 S	8/2002	Stone	
D466,332 S	12/2002	Risdon	
D466,333 S	12/2002	Hwang	
6,515,262 B1	2/2003	Li	
D475,225 S	6/2003	McBrayer	
D477,160 S	7/2003	Grosfillex	
D478,432 S	8/2003	Juneau	
D479,925 S	9/2003	Hsieh	
D485,098 S	1/2004	Harris	
D485,451 S	1/2004	De Blois	
D485,709 S	1/2004	De Blois	
D487,200 S	3/2004	Wanek	
D488,002 S	4/2004	Wanek	
D492,860 S	7/2004	Bertoncini	
D492,989 S	7/2004	Beck	
D493,043 S	7/2004	Juneau	
D494,774 S	8/2004	De Blois	
D495,162 S	8/2004	Anderson et al.	
D495,527 S	9/2004	Walker	
D495,898 S	9/2004	Walker	
D496,190 S	9/2004	Muhundro	
D497,741 S	11/2004	Sexton	
D499,274 S	12/2004	Juneau	
D499,281 S	12/2004	Yamaguchi	
D499,583 S	12/2004	Anderson et al.	
D502,821 S	3/2005	Muhundro	
D503,297 S	3/2005	Muhundro	
D505,574 S	5/2005	Sexton	
D506,089 S	6/2005	Muhundro	
D508,347 S	8/2005	Juneau	
D510,211 S	10/2005	Welborn, Jr.	
D511,053 S	11/2005	Peterson	
D511,055 S	11/2005	Draheim	
D511,254 S	11/2005	Draheim	
D512,247 S	12/2005	Prillaman	
D512,852 S	12/2005	Peterson	
D513,371 S	1/2006	Juneau	
D515,842 S	2/2006	Peterson	
D516,342 S	3/2006	Mohundro	
D519,203 S	4/2006	Haas et al.	
D519,299 S	4/2006	Boudreau	
D520,777 S	5/2006	DeBlois	
D522,270 S	6/2006	Roeseler	
D522,771 S	6/2006	Berry et al.	
D525,049 S	7/2006	Mohundro	
D526,814 S	8/2006	Juneau	
D528,327 S	9/2006	O'Reilly	
D529,309 S	10/2006	Juneau	
D531,835 S	11/2006	Harwanko	
D532,992 S	12/2006	Kingsley	
D533,731 S	12/2006	Boerner et al.	
D533,732 S	12/2006	Juneau	
D534,009 S	12/2006	Juneau	
D534,379 S	1/2007	Juneau	
D535,492 S	1/2007	Domack	
D539,057 S	3/2007	Senda et al.	
D542,057 S	5/2007	Juneau	
D543,056 S	5/2007	Chou	
D543,057 S	5/2007	Grady et al.	
D543,728 S	6/2007	Becker et al.	
D548,488 S	8/2007	Weatherly	
D548,490 S	8/2007	Becker et al.	
D549,490 S	8/2007	Brimacombe	
D549,989 S *	9/2007	Thompson	D6/671.1
D549,991 S	9/2007	Stravitz	
D554,390 S	11/2007	Thompson	
D554,393 S	11/2007	Yalif	
D555,397 S	11/2007	Yalif	
D559,583 S	1/2008	Zambelli	
D559,584 S	1/2008	Zambelli	
D560,077 S	1/2008	Zambelli	
D560,388 S	1/2008	Bacon	
D560,396 S	1/2008	Weatherly	
D560,930 S	2/2008	Woodward et al.	
D560,932 S *	2/2008	Draheim	D6/671.1
D560,933 S	2/2008	Sexton	
D561,317 S	2/2008	Ou et al.	
D562,597 S	2/2008	Weatherly	
D564,789 S	3/2008	DeCarolis	
D567,346 S	4/2008	Lin	
D568,078 S	5/2008	Kohagen	
D568,631 S	5/2008	Martin et al.	
D569,127 S	5/2008	Kanhasamy	
D587,483 S	3/2009	Zambelli	
D587,484 S	3/2009	Domack et al.	
D587,497 S	3/2009	Zambelli	
D588,831 S	3/2009	Mohundro	
D588,836 S *	3/2009	Everson	D6/671.1
D589,280 S	3/2009	Zambelli	
D591,533 S	5/2009	Karsson	
7,530,538 B2	5/2009	Whalen et al.	
D593,776 S	6/2009	Sexton	
D594,248 S	6/2009	Zambelli	
D594,249 S	6/2009	Newton	
D596,421 S	7/2009	Kanhasamy	
D599,134 S	9/2009	Jeup	
D601,368 S	10/2009	Calco	
D604,546 S	11/2009	Alman et al.	
D604,959 S	12/2009	Good	
D605,438 S	12/2009	Hand	
D605,874 S	12/2009	Zambelli	
D609,496 S	2/2010	Kanhasamy	
D609,497 S	2/2010	Kanhasamy	
D609,501 S	2/2010	Sexton	
D610,831 S	3/2010	Hand	
D611,727 S	3/2010	Vail	
D613,967 S	4/2010	Sexton	
D614,421 S	4/2010	Sexton	
D614,888 S	5/2010	Sexton	
D618,015 S	6/2010	Sexton	
D620,278 S	7/2010	Zambelli	
D620,283 S	7/2010	Calco	

(56)

References Cited

U.S. PATENT DOCUMENTS

D622,834 S	8/2010	Jiang	D752,905 S	4/2016	Healy et al.
D623,442 S	9/2010	Zambelli	D753,930 S	4/2016	Vengadakrishnan
D623,876 S	9/2010	Zambelli	D757,350 S	5/2016	Levy et al.
D623,877 S	9/2010	Zambelli	D758,766 S	6/2016	Kirar
D624,633 S *	9/2010	Watts D23/286	D759,997 S	6/2016	Ruiz et al.
D625,123 S	10/2010	Zambelli	D763,604 S	8/2016	Weatherly
D626,635 S	11/2010	Thomas	D766,021 S	9/2016	Burden
D627,994 S	11/2010	Wahl	D767,307 S	9/2016	Migeon
D628,828 S	12/2010	Everson	D767,752 S	9/2016	Davis et al.
D630,453 S	1/2011	Rafieha	D767,753 S	9/2016	Edmund
D632,902 S	2/2011	Rafieha	D773,862 S	12/2016	Davis et al.
D638,234 S	5/2011	Kirkeby et al.	D775,866 S	1/2017	Ben Avi
D638,922 S	5/2011	Zhou	D777,479 S	1/2017	Anderson
7,934,494 B1	5/2011	Schneider	D778,641 S	2/2017	Anderson
D640,072 S	6/2011	Sexton	D778,646 S	2/2017	Davis et al.
D641,861 S	7/2011	Okamoto et al.	D783,324 S	4/2017	Akana et al.
D644,853 S	9/2011	Becker et al.	D790,887 S *	7/2017	Everson D6/671.1
D653,051 S	1/2012	Lin	D791,302 S	7/2017	Davis et al.
D653,739 S	2/2012	Gibbs	D791,516 S	7/2017	Everson et al.
D654,289 S	2/2012	Zambelli	D791,522 S	7/2017	Rafieha
D654,995 S	2/2012	Asofsky et al.	D792,132 S	7/2017	Peota et al.
D654,996 S	2/2012	Asofsky et al.	D793,776 S	8/2017	Davis et al.
D655,946 S	3/2012	Sexton	D798,640 S	10/2017	Anderson
D658,750 S	5/2012	Nemes	D804,861 S	12/2017	Failing
D663,137 S	7/2012	Andersen	D805,814 S	12/2017	Ginestra
D663,138 S	7/2012	Andersen et al.	D805,817 S	12/2017	Beckman
D663,549 S *	7/2012	Domack D6/668.2	D807,671 S	1/2018	Caillouet
D665,897 S	8/2012	Martin	D808,199 S	1/2018	Fitzgerald
D666,281 S	8/2012	Nemes	D808,202 S	1/2018	Hawkins et al.
D667,654 S	9/2012	Lenney	D808,203 S	1/2018	Davis et al.
D668,475 S	10/2012	Zambelli	D808,688 S	1/2018	Everson et al.
D669,704 S	10/2012	Zambelli	D808,690 S	1/2018	Hsu
D669,706 S	10/2012	Zambelli	D812,935 S	3/2018	Hannoosh
D669,707 S	10/2012	Zambelli	D812,938 S	3/2018	Moore
D671,769 S	12/2012	Olson	D813,573 S	3/2018	Hannoosh
D674,891 S	1/2013	Huang	D814,410 S	4/2018	Emslie
D675,716 S	2/2013	Schwartz	D815,465 S	4/2018	Hannoosh
D675,846 S	2/2013	Monaldi et al.	D815,466 S	4/2018	Hannoosh
D677,074 S	3/2013	Olson	D815,467 S	4/2018	Hannoosh
D687,250 S	8/2013	Weatherly	D815,468 S	4/2018	Hannoosh
D694,873 S	12/2013	Nemes et al.	D817,037 S	5/2018	Davis et al.
D696,758 S	12/2013	Ernst	D817,038 S	5/2018	Davis et al.
8,607,776 B2	12/2013	Jansson et al.	D817,040 S	5/2018	Davis et al.
8,813,656 B1	8/2014	Hazzard et al.	D817,666 S	5/2018	Davis et al.
D716,288 S	10/2014	O'Heron et al.	D817,667 S	5/2018	Davis et al.
D717,081 S	11/2014	Dworman	D818,745 S *	5/2018	Hannoosh D6/671.1
D717,569 S	11/2014	Davis et al.	D819,372 S *	6/2018	Kraemer D6/657
D718,956 S	12/2014	Helser	D824,703 S	8/2018	Yamamoto
D718,957 S	12/2014	Helser	D825,233 S	8/2018	Yamamoto
D719,384 S	12/2014	Sowers et al.	D825,959 S	8/2018	Rockwell et al.
D720,563 S	1/2015	Burden	D832,613 S	11/2018	Parikh
D721,907 S	2/2015	Boll-Wilson	D833,782 S	11/2018	Amacher, Jr.
D722,788 S	2/2015	Everson et al.	D834,354 S	11/2018	Davis et al.
D723,148 S	2/2015	Lawrence et al.	D834,355 S	11/2018	Davis et al.
D723,843 S	3/2015	Lai	D835,437 S	12/2018	Stukenberg et al.
D725,410 S	3/2015	Park	D835,925 S	12/2018	Denby et al.
9,004,060 B2	4/2015	Benedetti et al.	D838,517 S	1/2019	Knox
D731,823 S	6/2015	Kelinske et al.	D838,518 S	1/2019	Knox
D734,068 S	7/2015	Dworman	D838,519 S	1/2019	Knox
D736,012 S	8/2015	Davis et al.	D838,523 S	1/2019	Yamamoto
D737,418 S	8/2015	Hrydovyy	D843,756 S	3/2019	Johnson et al.
D738,142 S	9/2015	Glattstein	D845,041 S	4/2019	Davis et al.
D738,477 S	9/2015	Nemes et al.	D845,679 S	4/2019	Li
D738,647 S	9/2015	Muller	D845,683 S	4/2019	Pedersen et al.
D741,630 S	10/2015	Meissner et al.	D848,766 S	5/2019	Chen
9,167,896 B1	10/2015	Wu	D848,767 S	5/2019	Smrstick
D742,142 S	11/2015	Everson et al.	D848,768 S	5/2019	Johnson et al.
D742,662 S	11/2015	Muller	D848,770 S	5/2019	Davis et al.
D743,192 S	11/2015	Davis et al.	D856,042 S	8/2019	Davis et al.
D746,614 S	1/2016	Sheppard	D856,043 S	8/2019	Davis et al.
D747,123 S	1/2016	Zambelli	D857,326 S	8/2019	Hu
D747,788 S	1/2016	Baker	D861,387 S	10/2019	Bray
D747,900 S	1/2016	Sheppard	D861,388 S	10/2019	Bray
9,228,742 B2	1/2016	Akiyama et al.	D861,389 S	10/2019	Bray
D748,768 S	2/2016	Stanton	D861,393 S	10/2019	Pederson
			D862,134 S	10/2019	Bray
			D862,135 S	10/2019	Birch
			D862,939 S	10/2019	Bray
			D862,940 S	10/2019	Bray

(56)

References Cited

U.S. PATENT DOCUMENTS

D862,943 S 10/2019 Nakamura
 D862,944 S 10/2019 Nakamura
 D862,947 S 10/2019 Grupenhof
 D863,841 S 10/2019 Dumouchel
 D863,843 S 10/2019 Li
 D867,033 S 11/2019 Bellini
 D867,791 S 11/2019 Birch
 D871,806 S 1/2020 Young
 D878,116 S 3/2020 Davis et al.
 D880,907 S 4/2020 Leng
 D881,613 S 4/2020 Leng
 D885,091 S 5/2020 Davis et al.
 D885,798 S 6/2020 Sumlin
 D886,496 S 6/2020 Davis et al.
 D889,170 S 7/2020 Knox
 D889,886 S 7/2020 Birch
 D891,831 S 8/2020 Davis
 D894,641 S 9/2020 Davis
 D894,644 S 9/2020 Knox
 D895,328 S 9/2020 Knox
 D895,329 S 9/2020 Knox
 D896,008 S 9/2020 Xiao
 D904,802 S 12/2020 Davis
 D905,480 S 12/2020 Bakker
 D906,020 S 12/2020 Davis
 D906,021 S 12/2020 Davis
 D906,739 S 1/2021 Bakker
 D911,078 S 2/2021 Harris
 D911,079 S 2/2021 Harris
 D912,443 S 3/2021 Li
 D913,022 S 3/2021 Li
 D914,400 S 3/2021 Davis
 D916,538 S 4/2021 Xiao
 D920,014 S 5/2021 Chu
 D920,016 S 5/2021 Ye
 D922,798 S 6/2021 Packer
 D922,799 S 6/2021 Davis et al.
 D926,500 S 8/2021 Davis
 D927,230 S 8/2021 Stravitz
 D929,159 S 8/2021 Davis
 D929,779 S 9/2021 Davis
 D931,016 S 9/2021 Davis
 D931,018 S 9/2021 Huang
 D932,815 S 10/2021 Polidoros
 D934,597 S 11/2021 Nakhla
 D935,237 S 11/2021 Davis
 D935,810 S 11/2021 Davis
 D936,397 S 11/2021 Chen
 D936,399 S 11/2021 Packer et al.
 D939,868 S 1/2022 Chen
 D941,617 S 1/2022 Kobayashi
 D944,572 S * 3/2022 Davis D6/671.1
 D946,318 S 3/2022 Packer et al.
 D946,326 S 3/2022 Packer et al.
 D946,936 S 3/2022 Davis et al.
 D946,937 S 3/2022 Li
 D953,781 S 6/2022 Hu
 D957,166 S 7/2022 Davis et al.
 D957,168 S 7/2022 Li
 11,391,082 B2 7/2022 Hervey
 D966,758 S 10/2022 Duhadway
 D978,581 S 2/2023 Naylor
 D978,582 S 2/2023 Jones et al.
 D979,294 S 2/2023 Duhadway
 D988,036 S 6/2023 Duhadway
 D992,935 S 7/2023 Naylor
 D1,000,876 S 10/2023 Tong
 D1,003,087 S 10/2023 Tong
 D1,005,748 S 11/2023 Tong
 D1,006,501 S 12/2023 Naylor
 D1,007,202 S 12/2023 Chen
 2004/0055980 A1 3/2004 Krieger
 2004/0074858 A1 4/2004 Thuma et al.
 2004/0079714 A1 4/2004 Andrew et al.
 2004/0222721 A1 11/2004 Kelley et al.

2004/0237853 A1 12/2004 Sholz
 2005/0000241 A1 1/2005 Kucera et al.
 2005/0103734 A1 5/2005 Saltzberg et al.
 2007/0062983 A1 3/2007 Barnett et al.
 2007/0138119 A1 6/2007 Schwerdlin
 2007/0236111 A1 10/2007 Gray
 2007/0257587 A1 11/2007 Jackson
 2008/0181587 A1 7/2008 Patil et al.
 2008/0203042 A1 8/2008 Felsenthal
 2008/0216817 A1 9/2008 Yungbluth
 2009/0025414 A1 1/2009 Koga et al.
 2009/0151375 A1 6/2009 Tarr et al.
 2009/0170421 A1 7/2009 Adrian et al.
 2009/0220221 A1 9/2009 Zhou
 2010/0242405 A1 9/2010 Esbaum
 2010/0307179 A1 12/2010 Fava
 2011/0000477 A1 1/2011 Kwon et al.
 2011/0017691 A1 1/2011 Wu
 2011/0079688 A1 4/2011 Grove
 2011/0080261 A1 4/2011 Asofsky et al.
 2011/0120166 A1 5/2011 Nadel et al.
 2011/0220090 A1 9/2011 Atemboski et al.
 2013/0126452 A1 5/2013 Lo
 2013/0127316 A1 5/2013 Wu
 2014/0116418 A1 5/2014 Thomas
 2014/0231404 A1 8/2014 Struck
 2014/0252939 A1 9/2014 Tunzi
 2014/0265754 A1 9/2014 Patterson
 2014/0265807 A1 9/2014 Kendall et al.
 2014/0318529 A1 10/2014 Nielsen
 2015/0182021 A1 7/2015 Chang
 2015/0323190 A1 11/2015 Stein
 2016/0018112 A1 1/2016 Phillips et al.
 2016/0100698 A1 4/2016 Clark et al.
 2016/0120311 A1 5/2016 Huang
 2016/0209102 A1 7/2016 Vulava et al.
 2016/0223213 A1 8/2016 Grohova
 2016/0256032 A1 9/2016 Bhajak et al.
 2017/0211814 A1 7/2017 Bourne et al.
 2018/0064246 A1 3/2018 Kassanoff et al.

FOREIGN PATENT DOCUMENTS

CA 211192 S 9/2023
 CN 306417669 S 3/2021
 CN 307399177 S 6/2022
 EM 003734177-0048 2/2017
 EM 008915169-0002 3/2022
 GB 1162368 A 8/1969
 GB 6104568 10/2020
 GB 6115240 1/2021

OTHER PUBLICATIONS

Youiuhoms, posted Jun. 15, 2023 [online], [retrieved Jun. 23, 2023]. Retrieved from internet [\(https://www.amazon.com/dp/B0C859WLWW/ref=sr_1_101?crd=IIA34R9K8V05S&keywords=chest+for+clothes&qid=1686909479&sr=8-101\(Date:2023\)\)](https://www.amazon.com/dp/B0C859WLWW/ref=sr_1_101?crd=IIA34R9K8V05S&keywords=chest+for+clothes&qid=1686909479&sr=8-101(Date:2023)) (Year: 2023).*

Welwick Designs, posted Mar. 15, 2022 [online], [retrieved Jun. 23, 2023]. Retrieved from internet, [\(https://www.homedepot.com/p/Welwick-Designs-52-in-W-6-Drawer-White-Oak-Dresser-with-Faux-Double-Drawers-HD9155/319045390\(Date:2023\)\)](https://www.homedepot.com/p/Welwick-Designs-52-in-W-6-Drawer-White-Oak-Dresser-with-Faux-Double-Drawers-HD9155/319045390(Date:2023)) (Date:2023).*

U.S. Appl. No. 29/884,258, filed Feb. 9, 2023, Duhadway.
 U.S. Appl. No. 29/884,259, filed Feb. 9, 2023, Duhadway.
 U.S. Appl. No. 29/884,260, filed Feb. 9, 2023, Duhadway.
 U.S. Appl. No. 29/677,754, filed Jan. 23, 2019, Davis.
 U.S. Appl. No. 29/698,929, filed Jul. 22, 2019, Davis.
 U.S. Appl. No. 29/698,933, filed Jul. 22, 2019, Davis.
 U.S. Appl. No. 29/698,934, filed Jul. 22, 2019, Davis.
 U.S. Appl. No. 29/699,073, filed Jul. 23, 2019, Davis.
 U.S. Appl. No. 29/720,725, filed Jan. 15, 2020, Davis.
 U.S. Appl. No. 29/721,169, filed Jan. 17, 2020, Davis.
 U.S. Appl. No. 29/743,596, filed Jul. 22, 2020, Packer.
 U.S. Appl. No. 29/743,597, filed Jul. 22, 2020, Packer.
 U.S. Appl. No. 29/767,920, filed Jan. 26, 2021, Duhadway.
 U.S. Appl. No. 29/767,921, filed Jan. 26, 2021, Duhadway.

(56)

References Cited

OTHER PUBLICATIONS

U.S. Appl. No. 29/767,926, filed Jan. 26, 2021, Duhadway.
 U.S. Appl. No. 29/768,124, filed Jan. 27, 2021, Naylor.
 U.S. Appl. No. 29/801,171, filed Jul. 27, 2021, Duhadway.
 U.S. Appl. No. 29/825,533, filed Feb. 2, 2022, Naylor.
 U.S. Appl. No. 29/825,538, filed Feb. 2, 2022, Naylor.
 U.S. Appl. No. 29/825,543, filed Feb. 2, 2022, Naylor.
 U.S. Appl. No. 29/825,664, filed Feb. 3, 2022, Duhadway.
 U.S. Appl. No. 29/825,668, filed Feb. 3, 2022, Duhadway.
 U.S. Appl. No. 29/825,972, filed Feb. 8, 2022, Naylor.
 U.S. Appl. No. 29/830,013, filed Mar. 9, 2022, Naylor.
 U.S. Appl. No. 29/792,313, filed Mar. 21, 2022, Naylor.
 U.S. Appl. No. 29/830,020, filed Mar. 9, 2022, Naylor.
 Pinterest; 5050 Lacquered bedside table by Molteni & C.; <https://www.pinterest.com/pin/33636328453042318/>; Retrieved on Oct. 15, 2018.
 Archiproducts; 5050 Lacquered bedside table by Molteni & C.; https://www.archiproducts.com/en/products/molteni-c/wooden-bedside-table-with-drawers-5050-lacquered-bedside-table_246952/; Retrieved on Oct. 15, 2018.
 Pinterest; Cabinet Furniture; Furniture Design collezione 2011 Ottoman Box by Aksu <https://www.pinterest.com/pin/33636328452974953/>; Retrieved on Nov. 25, 2019.
 Cole; Container; <http://coletonalia.com/product/ottoman-box/>; Retrieved on Nov. 25, 2019.
 Carson Carrington Longyearbyen Mid-century Modern Nightstand, Overstock.com, review date with photograph of Jan. 22, 2019, site visited Dec. 9, 2020, available online at <https://www.overstock.com/Home-Garden/Carson-Carrington-Longyearbyen-20-inch-Mid-century-2-drawer-Nightstand/25482942/customer-reviews.html> (Year: 2019).
 Mid-Century Solid Pine Three-Drawer Storage Chest, Middlebrook Designs, Overstock.com, review date with photo of Jun. 8, 2019, site visited Dec. 9, 2020, available online at <https://www.overstock.com/Home-Garden/Mid-Century-3-Drawer-Chest/25483239/customer-reviews.html> (Year: 2019).
 West Elm Mid-Century 6-Drawer Dresser, Copycatchic.com, Apr. 7, 2016, site visited Dec. 10, 2020, available online at <https://www.bloglovin.com/blogs/copy-catchic-1715405/west-elm-mid-century-6-drawer-dresser-4825048972> (Year: 2016).
 YouTube; Bourbon Moth Woodworking; Mid Century Walnut Hutch Build/ How-To; Jul. 24, 2018; <https://www.youtube.com/watch?v=R8a4TynV67o&feature=youtu.be>.
 Appliancesconnection.com; Walker Edison Buffet BU52SV6D; retrieved on Mar. 11, 2021; <https://www.appliancesconnection.com/walker-edison-bu52sv6d.html>.
 “Walker Edison Furniture AZR2DSLNSCA nightstand Caramel.” Found online Mar. 26, 2021 at [www.amazon.com](https://www.amazon.com/WE-Furniture-AZR3DSLDRWI-Dresser-Walnut/dp/B07N26W6PG?th=1). Product reviewed Apr. 15, 2019. Retrieved from URL: <https://www.amazon.com/WE-Furniture-AZR3DSLDRWI-Dresser-Walnut/dp/B07N26W6PG?th=1> (Year: 2019).
 Eden Bridge Designs Mid Century Nightstand. Found online Mar. 26, 2021 at www.amazon.co.uk. Product first available Apr. 22, 2019. Retrieved from URL: https://www.amazon.co.uk/WE-Furniture-Century-Nightstand-Storage/dp/B07QXLKMWW?ref=ast_sto_dp&th=1 (Year: 2019).
 “Sonoma 2-Drawer Walnut Nightstand by Bellamy Studios.” Found online Mar. 26, 2021 at www.walmart.com. Product reviewed Mar. 21, 2020. Retrieved from URL: <https://tinyurl.com/2yahxxzc> (Year: 2020).
 Eden Bridge Design Modern Midcentury Dresser. Found online Mar. 26, 2021 at www.amazon.co.uk. Product first available 0 Jan. 23, 2019. Retrieved from URL: <https://tinyurl.com/r6uscnuw> (Year: 2019).
 Walker Edison 3 Drawer. Found online Mar. 26, 2021 at www.amazon.com. Product reviewed Apr. 15, 2019. Retrieved from URL: https://www.amazon.com/WE-Furniture-AZR6DSLDRCA-Dresser-Caramel/dp/B07N28F4BL/ref=dp_fod_3?pd_rd_j=B07N26VX8S&th=1 (Year: 2019).

Desert Fields Sonoma 3-Drawer Caramel Dresser. Found online Mar. 26, 2021 at www.walmart.com. Product reviewed May 16, 2019. Retrieved from URL: <https://www.walmart.com/lp/Desert-Fields-Sonoma-3-Drawer-Caramel-Dresser/753739235?selected=true> (Year: 2019).
 “Eden Bridge Designs Dresser.” Found online Mar. 26, 2021 at www.amazon.co.uk. Product first available Jan. 23, 2019. Retrieved from URL: <https://www.amazon.co.uk/WE-Furniture-Walker-Century-Dresser/dp/B07N26VX8S> (Year: 2019).
 “Carson Carrington Gammelstaden Mid-century 6-drawer Dresser.” Found online Mar. 26, 2021 at www.overstock.com. Product reviewed Jan. 24, 2019. Retrieved from URL: <https://tinyurl.com/3uxxs7vu> (Year: 2019).
 “Desert Fields Sonoma 6-Drawer.” Found online Mar. 26, 2021 at www.walmart.com. Product reviewed Feb. 6, 2019. Retrieved from URL: <https://tinyurl.com/bs9jfv9t> (Year: 2019).
 “Walker Edison Furniture AZR6DSLDRCA Dresser Caramel.” Found online Mar. 26, 2021 at www.amazon.com. Product reviewed May 25, 2019. Retrieved from URL: https://www.amazon.com/WE-Furniture-AZR6DSLDRWT-Dresser-Walnut/dp/B07N26VX8S/ref=dp_fod_2?pd_rd_i=B07N27XGSC&th=1 (Year: 2019).
 Bridgeport by Hopewood; Found online on Mar. 29, 2021 at <https://hubbingtons.com/product-category/bridgeport-by-hopewood/>.
 Dovetail Furniture DOV Bridgeport Chest Grey; Found online on Mar. 29, 2021 at <https://www.goodshomefurnishings.com/dovetail-furniture-bridgeport-chest-grey/dov18028-p71/iteminformation.aspx>.
 Renegar 2 Door Accent Cabinet; Wayfair.com; found online Apr. 21, 2021; retrieved May 3, 2021 (online); <https://www.wayfair.com/furniture/pdp/gracie-oaks-renegar-2-door-accent-cabinet-w001524010.html>.
 Albright TV Stand; Wayfair.com; found online Apr. 21, 2021; retrieved May 3, 2021 (online); <https://www.wayfair.com/furniture/pdp/three-posts-albright-tv-stand-w003419693.html?placement=1>.
 West Elm Website “furniture” search; Westelm.com; retrieved Apr. 20, 2020 (online); https://www.westelm.com/shop/furniture/?searchredir=true&cm_sp=HeaderLinks_-_OnsiteSearch_-_MainSite&cm_type=OnsiteSearch&term=furniture&searchredirtype=br.
 Walker Edison Blog Post, How to Style an Entryway to Impress; walkerredisonshop.com; retrieved Apr. 8, 2021 (online); <https://walkerredisonshop.com/blogs/news>.
 Raymour Flanigan Website “Living Rooms” search; raymourflanigan.com; retrieved Nov. 6, 2020 (online); <https://raymourflanigan.com/living-rooms>.
 Crate and Barrel Website “Business Interior Design” search; crateandbarrel.com; retrieved Nov. 6, 2020 (online); https://www.crateandbarrel.com/trade-program/?a=784&campaignid=1061902950&adgroupid=55881134521&targetid=aud-1097585102856:kwid-415008832538&adpos=&creative=251673559670&device=c&matchtype=e&network=g&gclid=Cj0KCQjwytOEBhD5ARIsANNRjVgCRKamP5yMqUG6rsNP7KAU-nUpzG5NfgZU-PhRCRUgz507ltMaAhVLEALw_wcB.
 Home Depot—Bridgeport Collection in Antique White; homedepot.com; retrieved May 13, 2020 (online); <https://www.homedepot.com/s/bridgeport%2520collection%2520in%2520antique%2520white?NCNI=5>.
 Stuart David—Bridgeport; stuartdavid.com; retrieved May 13, 2020 (online); https://www.stuartdavid.com/search?product_search_api_fulltext=Bridgeport&search_api_views_submit=Submit.
 Ohio Hardwood Furniture—Bridgeport 3 Drawer Armoire; ohiohardwoodfurniture.com; retrieved May 13, 2020 (online); <https://www.ohiohardwoodfurniture.com/products/bridgeport-3-drawer-armoire>.
 Cabinfield—Brideport Series; cabinfield.com; retrieved May 13, 2020 (online); <https://www.cabinfield.com/fine-furniture/bedroom/contemporary-collection/bridgeport-series-6281>.
 Stacy Furniture—Lexington Bedroom Bridgeport Bachelors Chests; stacyfurniture.com; retrieved May 13, 2020 (online); <https://www.stacyfurniture.com/lexington-bridgeport-bachelors-chest/714-624-8/iteminformation.aspx>.
 Winhome Furniture Collection, found online May 20, 2021 at <https://www.whfurni.com/collections/all>, and retrieved Jun. 3, 2021.

(56)

References Cited

OTHER PUBLICATIONS

“Walker Edison Wood Dresser.” Found online Jun. 16, 2021 at www.amazon.com. Product first available Sep. 4, 2018. Retrieved from URL: <https://www.amazon.com/WE-Furniture-AZR6DDDRWT-Dresser-Walnut/dp/B07H35NSL3?th=1> (Year: 2018).

“Ikea 8-drawer dresser.” Found on line Jun. 16, 2021 at www.amazon.com. Product first available Aug. 25, 2016. Retrieved from URL: <https://www.amazon.com/8-drawer-dresser-white-stain-228-52617-3834/dp/B01LOE13SC> (Year: 2016).

“Vasagle End Table . . .” Oct. 1, 2018, [amazon.com](https://www.amazon.com), site visited Sep. 22, 2021 <https://www.amazon.com/VASAGLE-Nightstand-Stackable-Compartment-Industrial/dp/B07B7LSKPQ/ref=cm_cr_ar_p_product_top?ie=UTF8> (Year: 2018).

Modern Storage Side Table by Home Accent Furnishings, first available: Jun. 9, 2020. [Amazon.com](https://www.amazon.com) [online], [site visited Jan. 4, 2022], Internet URL: <https://www.amazon.com/25-Modern-Storage-Side-Table/dp/B089WJ7H3K#customerReviews> (Year: 2020).

Elm 2—Drawer Storage Side Table by Forest Gate, first available: Jun. 24, 2021. [Bedbathandbeyond.com](https://www.bedbathandbeyond.com) [online], [site visited Jan. 4, 2022], Internet URL: <https://www.bedbathandbeyond.com/store/product/forest-gate-el-m-2-drawer-storage-side-table/5425720?strategy=recentlyViewed> (Year: 2021).

Dark Walnut Modern Storage Side Table by Walker Edison, first available: Aug. 16, 2021. [Bellacor.com](https://www.bellacor.com) [online], [site visited Jan. 4, 2022], Internet URL: <https://www.bellacor.com/productdetail/walker-edison-furniture-co-br25linnsdw-25-inch-dark-walnut-modern-storage-side-table-2232284.html> (Year: 2021).

Drawer Nightstand by Mercury Row, first available: Dec. 10, 2019. [Wayfair.com](https://www.wayfair.com) [online], [site visited Jan. 5, 2022], Internet URL: <https://www.wayfair.com/furniture/pdp/mercury-row-annie-2-drawer-nightstand-w004497852.html?piid=718200567> (Year: 2019).

Door Square Accent Cabinet by Ivy Bronx, first available: Aug. 8, 2019. [Wayfair.com](https://www.wayfair.com) [online], [site visited Jan. 5, 2022], Internet URL: <https://www.wayfair.com/furniture/pdp/ivy-bronx-glenni-2-door-square-accent-cabinet-net-wool062885.html?piid=1466162072> (Year: 2019).

Accent Entryway Bar Cabinet by Walker Edison, first available: Jul. 1, 2020. [Amazon.com](https://www.amazon.com) [online], [site visited Jan. 5, 2022], Internet URL: <https://www.amazon.com/Walker-Edison-Furniture-Company-AZF30AD-DSG/dp/B07VK78VKD?th=1> (Year: 2020).

Storage Cabinet by Forest Gate, first available: Apr. 1, 2020. [Bedbathandbeyond.com](https://www.bedbathandbeyond.com) [online], [site visited Jan. 5, 2022], Internet URL: <https://www.bedbathandbeyond.com/store/product/forest-gate-modern-30-inch-storage-cabinet-net/5438479?> (Year: 2020).

Walnut Kylie 3 Drawer Chest by Kirklands, first available: Aug. 8, 2019. [Kirklands.com](https://www.kirklands.com) [online], [site visited Apr. 20, 2022], Internet URL: <https://www.kirklands.com/product/Furniture/Bedroom-Furniture/Dressers-Chests/Walnut-Kylie-3-Drawer-Chest/pc/2285/c/3059/sc/2419/227303.uts> (Year: 2019).

Basalt 27.19" Tall 2 Drawer Nightstand by Laurel Foundry Modern Farmhouse, first available: Dec. 7, 2020. [Wayfair.com](https://www.wayfair.com) [online], [site visited Apr. 20, 2022], Internet URL: <https://www.wayfair.com/furniture/pdp/basalt-2-drawer-nightstand-in-natural-oak-dark-brown-w004030619.html> (Year: 2020).

Ormond 23.98" Tall 2 Drawer Nightstand by George Oliver, first available: May 5, 2020. [Wayfair.com](https://www.wayfair.com) [online], [site visited Apr. 20, 2022], Internet URL: <https://www.wayfair.com/furniture/pdp/george-oliver-ormond-2-drawer-solid-wood-nightstand-w005485830.html?piid=186751938#v2se7zwvgoa-6> (Year: 2020).

3 Drawer Walnut Stain Chest by StyleCraft, first available: Jul. 28, 2019. [Overstock.com](https://www.overstock.com) [online], [site visited Apr. 19, 2022], Internet URL: <https://www.overstock.com/Home-Garden/3-drawer-Walnut-Stain-Chest/20740974/product.html> (Year: 2019).

Carpenter 3 Chest by Mercury Row, first available: Aug. 9, 2020. [Overstock.com](https://www.overstock.com) [online], [site visited Apr. 19, 2022], Internet URL: <https://www.overstock.com/Home-Garden/3-drawer-Walnut-Stain-Chest/20740974/prod.uct.html> (Year: 2020).

Milo Mid Century Modern Chest by Prepac Store, first available: May 10, 2019. [Amazon.com](https://www.amazon.com) [online], [site visited Apr. 19, 2022],

Internet URL: https://www.amazon.com/Prepac-Century-Modern-Drawer-Chest/dp/B07RF9YNLC/ref=sr_1_1_267?th=1 (Year: 2019).

BDU52SV6DGW by Delacora, first available: Sep. 27, 2019. [Amazon.com](https://www.amazon.com) [online], [site visited Apr. 19, 2022], Internet URL: <https://www.amazon.com/Delacora-BDU52SV6DGW-WE-BDU52SV6D-Farmhouse-Sideboard/dp/B0888VKVGL?th=1> (Year: 2019).

Modern 4 Drawer Dresser by Home Accent Furnishings Store first available: Nov. 7, 2020. [Amazon.com](https://www.amazon.com) [online], [site visited Apr. 19, 2022], Internet URL: https://www.amazon.com/Modern-4-Drawer-Dresser-Caramel/dp/B08B43KX27/ref=sr_1_1_124 (Year: 2020).

Modern Wood 6 Drawer Buffet by Home Accent Furnishings Store, first available: Mar. 30, 2020. [Amazon.com](https://www.amazon.com) [online], [site visited Apr. 19, 2022], Internet URL: <https://www.amazon.com/Modern-Wood-6-Drawer-Buffet-Walnut/dp/B086MLJ3XH> (Year: 2020).

Milo Mid Century Modern Chest by Prepac Store; <https://www.homedepot.com/p/Prepac-Milo-Mid-Century-Modern-2-Drawer-Black-Nightstand-BDNR-1402-1/310031773>; retrieved on May 23, 2022.

Mainstays Modern 6 Drawer Dresser, Bedroom, Brown Walnut; <https://www.walmart.com/ip/Mainstays-Modern-6-Drawer-Dresser-Bedroom-Brown-Walnut/650521468?athbdg=L1300>; retrieved on Sep. 26, 2022.

Orana 25" Tall Solid Wood End Table with Storage by Wade Logan, first available: Sep. 21, 2020. [Wayfair.com](https://www.wayfair.com) [online], [site visited Sep. 29, 2022], Internet URL: <https://www.wayfair.com/furniture/pdp/wade-logan-orana-solid-wood-end-table-with-storage-w003336035.html> (Year: 2020).

Modern 4 Drawer Storage and Display Chest by Saracina Home, first available: Unknown. [Target.com](https://www.target.com) [online], [site visited: Dec. 4, 2022], Internet URL: <https://www.target.com/p/modern-4-drawer-storage-and-display-chest-birch-saracina-home/-/A-82821042> (Year: 2022).

Halden Contemporary 3 Drawer Accent Chest by Walker Edison, first available: Nov. 25, 2021. [Amazon.com](https://www.amazon.com) [online], [site visited: Dec. 4, 2022], Internet URL: https://www.amazon.com/Walker-Edison-Halden-Contemporary-Shelving/dp/B09ML4D27S/ref=ast_sto_dp&th=1 (Year: 2021).

Hall Tree with Bench by Corrigan Studio, first available: Oct. 24, 2020. [Wayfair.com](https://www.wayfair.com) [online], [site visited Dec. 3, 2022], Internet URL: <https://www.wayfair.com/furniture/pdp/corrigan-studio-malena-pine-solid-wood-hall-tree-with-bench-and-shoe-storage-w006636928.html?piid=1149040657> (Year: 2020).

U.S. Appl. No. 29/699,073, Sep. 16, 2020, Notice of Allowance.

U.S. Appl. No. 29/698,929, Dec. 14, 2020, Office Action.

U.S. Appl. No. 29/698,933, Dec. 17, 2020, Office Action.

U.S. Appl. No. 29/698,934, Dec. 17, 2020, Office Action.

U.S. Appl. No. 29/698,929, Apr. 2, 2021, Final Office Action.

U.S. Appl. No. 29/698,933, Apr. 2, 2021, Office Action.

U.S. Appl. No. 29/698,934, Apr. 2, 2021, Office Action.

U.S. Appl. No. 29/677,754, Jun. 23, 2021, Office Action.

U.S. Appl. No. 29/698,929, Jul. 20, 2021, Notice of Allowance.

U.S. Appl. No. 29/698,933, Jul. 20, 2021, Notice of Allowance.

U.S. Appl. No. 29/698,934, Jul. 20, 2021, Notice of Allowance.

U.S. Appl. No. 29/743,596, Sep. 30, 2021, Notice of Allowance.

U.S. Appl. No. 29/743,597, Oct. 1, 2021, Notice of Allowance.

U.S. Appl. No. 29/677,754, Oct. 20, 2021, Notice of Allowance.

U.S. Appl. No. 29/743,597, Nov. 12, 2021, Notice of Allowance.

U.S. Appl. No. 29/720,725, Jan. 28, 2022, Office Action.

U.S. Appl. No. 29/721,169, Jan. 28, 2022, Office Action.

U.S. Appl. No. 29/767,921, May 6, 2022, Office Action.

U.S. Appl. No. 29/767,926, May 6, 2022, Office Action.

U.S. Appl. No. 29/721,169, May 23, 2022, Notice of Allowance.

U.S. Appl. No. 29/720,725, May 26, 2022, Notice of Allowance.

U.S. Appl. No. 29/767,921, Aug. 23, 2022, Notice of Allowance.

U.S. Appl. No. 29/767,926, Oct. 13, 2022, Notice of Allowance.

U.S. Appl. No. 29/801,171, Oct. 20, 2022, Office Action.

U.S. Appl. No. 29/768,124, Jan. 3, 2023, Office Action.

U.S. Appl. No. 29/767,920, Jan. 12, 2023, Notice of Allowance.

19 Stylish, posted May 12, 2019 [online], [retrieved Jun. 20, 2023].

Retrieved from internet, <https://reviewed.usatoday.com/home-outdoors/features/19-stylish-furnishings-from-home-depot-to-transform-your-bedroom> (Date: 2023) (Year: 2019).

(56)

References Cited

OTHER PUBLICATIONS

45Wooden, posted Apr. 23, 2023 [online], [retrieved Jun. 23, 2023]. Retrieved from internet, <https://www.jcpennney.com/p/45-wooden-4-drawer-chest/ppr5008252699?ptmplType=regular&deptId=dept2000001> (Date: 2023) (Year: 2023).

55881134521&targetid=aud-1097585102856:kwd-415008832538&adpos=&creative=251673559670&device=c&matchtype=e&network=g&gclid=Cj0KCQjwytoEBhD5ARIsANnRjVgCRKameP5yMquG6rsNP7KAU-nUpzG5NfgZU-PhRCRUgz5071ttMaAhvLEALw wCB.

56in, posted Apr. 25, 2022 [online], [retrieved Jun. 23, 2023]. Retrieved from internet, <https://www.homedepot.com/p/Welwick-Designs-56-in-W-4-Drawer-Dark-Walnut-and-White-Poplar-Wood-Dresser-with-Gold-Hardware-HD8906/316783335> (Date: 2023) (Year: 2022).

Ackles 69.7" Hx47.2" W Standard Bookcase; <https://www.wayfair.com/furniture/pdp/gracie-oaks-ackles-697-h-x-472-w-standard-bookcase-w005162287.html>; Found online on Nov. 12, 2021; retrieved on Dec. 16, 2021.

Ameriwood Home Everett 70-inch . . . Dec. 6, 2016, overstock.com, site visited Mar. 2, 2018 <<https://www.overstock.com/Home-Garden/Ameriwood-Home-Everett-70-inch-Sonoma-Oak-TV-Stand-with-Glass-Doors/12710691/product.html>> (Year: 2016).

Audrey Woven Media Console 65"; <https://www.zinhome.com/audrey-woven-media-console-65/>; Retrieved on May 14, 2019.

Belham Living Hampton Chair Side Table—Black; <https://www.hayneedle.com/product/belham-living-hampton-chair-side-table-black.cfm>; Retrieved on May 15, 2019.

Belham Living Jamestown Rustic Coffee Table with Unique Driftwood Finish; <https://www.bayneedle.com/product/jamestown-rustic-coffee-table.cfm>; Retrieved on May 15, 2019.

Belham Living Trenton Industrial End Table; https://www.hayneedle.com/product/belham-living-trenton-industrial-end-table-new.cfm?source=pla&kwid=OccasionalTables%20iprefer&tid=REDU113-1&adtype=pla&kw=&gclid=EAlaIqOBChMlVou-6ve13wIVB8ZkChOZdAfEAKYyABEGlyMfD_BwE; Retrieved on May 15, 2019.

Boston Loft Furnishings . . . Nov. 7, 2016, themine.com, site visited Mar. 2, 2018 <https://www.themine.com/tv-stands/boston-loft-furnishings-reamrock-infrared-electric-fireplace-media-stand-with-convertible-corner_g2733659.html> (Year: 2016).

Brawley TV Stand; Wayfair.com; found online Apr. 21, 2021; retrieved May 4, 2021 (online); <https://www.wayfair.com/furniture/pdp/17-stories-brawley-tv-stand-for-tvs-up-to-65-w004231614.html>.

Burville Etagere Bookcase; Wayfair.com; found online Apr. 21, 2021; retrieved May 5, 2021 (online); <https://www.wayfair.com/furniture/pdp/gracie-oaks-burville-etagere-bookcase-grks3993.html>.

Caraway, posted unknown [online], [retrieved May 30, 2023]. Retrieved from internet, https://www.litfad.com/modern-white-stone-rectangular-kitchen-island-table-with-6-drawers-s-4105864.html?gclid=EAlaIqOBChMl971upGg_wlVhaXIC32eQvDEAQYBCABEGJWcvD_BwE (Date: 2023) (Year: 2023).

Cliffmay Slat Media Stand Light Oak Brown—Project 62; https://www.target.com/p/cliffmay-slat-media-stand-light-oak-brown-project-62-153/-/A-53517373?ref=tgt_adv_XS000000&AFID=google_pla_df&fndsrc=tao&CPNG=PLA_Furniture%2BShopping_Priority%2BBrands&adgroup=SC_Project+62&LID=700000001170770pgs&network=g&device=c&location=9029756&gclid=aw.ds&ds_rl=1246978&ds_rl=1247068&ds_rl=1246978&ref=tgt_adv_XS000000&AFID=google_pla_df&CPNG=PLA_Furniture+Shopping_Priority+Brands&adgro

Convenience Concepts Oxford Rectangle Coffee Table; <https://www.hayneedle.com/product/convenience-concepts-oxford-rectangle-coffee-table.cfm?source=pla&kwid=OccasionalTables%20newskus>

&tid=CONV338-5&adtype=pla&kw=&gclid=EAlaIqOBChMlhuZv9_ml3wIVWx-tBh_IrUA1tEAKYHyABEGJ2hPD_BwE; Retrieved on May 15, 2019.

Crum Steel Etagere Bookcase; <https://www.wayfair.com/furniture/pdp/gracie-oaks-crum-steel-etagere-bookcase-w003068802.html>; Found online on Nov. 12, 2021; retrieved on Dec. 16, 2021.

Czapla TV Stand for TVs up to 65"; <https://www.allmodern.com/furniture/pdp/mercury-row-ctzapla-tv-stand-for-tvs-up-to-65-a000303456.html>; Retrieved on May 7, 2019.

Demilune Mesh Door Industrial Sideboard; https://bellescape.com/demilune-mesh-wire-door-industrial-chic-sideboard.html?_SID=U; Retrieved on May 14, 2019.

Dews 31.9" Hx35.4" W Bookcase; <https://www.wayfair.com/Gracie-Oaks--Dews-Etagere-Bookcase-X116473923-L38-K-W005362812.html?refid=FR49-W005362812>; retrieved on Aug. 25, 2022.

Draine 47.2" Hx25.9" W Steel Etagere Bookcase; <https://www.wayfair.com/furniture/pdp/gracie-oaks-draine-etagere-bookcase-w003035575.html>; Found online on Nov. 12, 2021; retrieved on Dec. 16, 2021.

Eden Bridge Designs Mid Century Nightstand. Found online Mar. 26, 2021 at www.amazon.co.uk. Product first available Apr. 22, 2019. Retrieved from URL: https://www.amazon.co.uk/WE-Furniture-Century-Nightstand-Storage/dp/B07QXLKMWW?ref=ast_sto_dp&th=1 (Year: 2019).

Electric fireplace, image post date May 26, 2014, site visited Aug. 8, 2016, (online), <<https://www.tineye.com/search/3c3d0cbfb7030b3079ebefa0774a5b4e94120332/?pluginver>

Final Office Action received for U.S. Appl. No. 29/611,962 mailed on Aug. 2, 2019.

FurnitureMaxx Besteen Contemporary Wood Dark Gray Dining Room Server; https://www.amazon.com/dp/B07GVS1VK2/ref=cm_sw_r_pi_dp_U_x_evuOBbFM3298G; Retrieved on May 14, 2019.

Geo-Marquetry Buffet; https://www.anthropologie.com/shop/geo-marquetry-buffet?adpos=1027&adtype=pl a&cm_mmc=Google-US%20-%20Shopping%20-%20Furniture-_-Organizing%20and%20Storage-_-42699934&color=&countryCode=US&creative=191389729567 &device=c&gclid=EAlaIqOBChMlVtGgYOH3wIVEdNkCh3t8wRPEAKYgyABEGJG_PD_BwE&inventoryCountry=US&matchtype=&mrkgadid=3202938336&mrkgclid=694&network=g&product_id=42699934&

Gracie Oaks Tobar 61.81" Hx23.6" W Iron Etagere Bookcase—Wayfair; <https://www.wayfair.com/furniture/pdp/gracie-oaks-tobar-solid-wood-etagere-bookcase-w003077378.html>; Found online on Nov. 12, 2021; retrieved on Dec. 16, 2021.

Griffie Manufactured Wood Nightstand by Mercury Row, first available: Apr. 23, 2021. Wayfair.com [online], [site visited Apr. 18, 2023], Internet URL: <https://www.wayfair.com/furniture/pdp/mercury-row-griffie-1-drawer-nightstand-w004865766.html> (Year: 2021).

Hal TV Stand for TVs up to 60"; <https://www.allmodern.com/furniture/pdp/hal-tv-stand-for-tvs-up-to-60-a000176456.html>; Retrieved on May 7, 2019.

Hampton Weathered Taupe Gray Coffee Table; https://www.homedepot.com/p/international-concepts-hampton-weathered-taupe-gray-coffee-table-OT09-70C/302946359?MERCH=REC_-PIPHorizontal2-rr_-204737265_302946359_-N; Retrieved on May 15, 2019.

Hooker Furniture Melange Mirrored Angle Console; https://www.furniture.com/hooker-melange-mirrored-angle-console.html?gclid=gdN21650_a_7c92_a_7c8357_a_7c654170&gclid=CjwKEAIA05unBRCymlGilanF9SwSJACqDFRm1WwgePUSp65sXRC14RkJfScYn--yCjNuB-GTt3W-FxoCQL7w_wcB; Retrieved on May 14, 2019.

Industrial Console Sofa Table, 3-Tier Foyer Tables for Entryway/Hallway with Storage Shelves, Narrow Table for Living Room, 39in Rustic Gray; <https://www.amazon.com/Industrial-Console-Entryway-Hallway-Storage/dp/B09C7XMXV5?source=ps-sl-shoppingads-lpcontext&ref=fplfs&pvc=1&smid=AK006DBOHE50Z>; retrieved on Aug. 25, 2022.

Industrial Rustic Pipe Frame Bookcase, <https://www.inspireq.com/collections/living-room/products/large-bookcase-e450-1213a>, retrieved on May 26, 2021, available on information and believe as early as Apr. 2015.

(56)

References Cited

OTHER PUBLICATIONS

International Concepts Hampton End Table; <https://www.hayneedle.com/product/internationalconceptshamptonendtable.cfm?source=pla&kwid=OccasionalTables%20level05&tid=WWI545-1&adtype=pla&kw=&gclid=EAIaIQobChMIpsnoqml3wIVGNVCh348qtdEAKYliABEqLP7fDBwE>; Retrieved on May 15, 2019.

Jaydyn Media TV Stand/Credenza; https://www.macys.com/shop/product/jaydyn-media-tv-stand-credenza?ID=288321o&CategoryID=35319#fn=FURNITURE_CATEGORY=Buffet%20%&sp=20Sideboards&SIZE=&sp=3&spc=131&ruleId=129%7CBOOST%20ATTRIBUTE%7CBOOST%20SAVED%20SET&searchPass=matchNone&slotId=2; Retrieved on May 14, 2019.

Jolene, posted Apr. 23, 2023 [online], [retrieved Jun. 23, 2023]. Retrieved from internet, https://walkerredison.com/products/jolene-45-4-drawer-grooved-wardrobe?_pos=1&_sid=5999dde9d&_ss_r (Date:2023) (Year: 2023).

Jones Horizontal, posted Jun. 23, 2021 [online], [retrieved Jun. 23, 2023]. Retrieved from internet, <https://www.target.com/p/jones-horizontal-modern-4-drawer-dresser-dark-walnut-saracina-home/-/A-82826064?preselect=82826064#Ink=sametab> (Date:2023) (Year: 2021).

Jummico TV Stand for 55 Inch TV Narrow Console Table with 3-Tier Storage Shelves Industrial Entryway Sofa Table for Living Room, Hallway, Bedroom (Grey and White); <https://www.amazon.com/JUMMICO-Console-Industrial-Entryway-Corridor/dp/B09XHKHK4H>; retrieved on Aug. 25, 2022.

Katheryn, posted Mar. 26, 2021 [online], [retrieved May 30, 2023]. Retrieved from internet, <https://www.wayfair.com/furniture/pdp/greyleigh-katheryn-45-4-drawer-grooved-wardrobe-wo04866270.html?pid=698884369#51zckc5u3q3-3> (Date:2023) (Year: 2021).

Kendall Electric Media Fireplace—Espresso Dec. 24, 2012, amazon.com, site visited Mar. 6, 2018 <<https://www.amazon.com/Kendall-Electric-Media-Fireplace-Espresso/dp/B009LIT6XQ/> ref=cm er am d producttop?ie=UTF8> (Year: 2012).

Knoebel Industrial 4-Tier Bookcase, retrieved from https://www.amazon.com/Knoebel-Industrial-Bookcase-Storage-Display/dp/B088GP4TD5/ref=sr_1_786?dchild=1&m=A3P20C6SOQ47R1&marketplaceID=ATVPDKIKXODER&qid=1627316183&s=merchant-items&sr=1-786&th=1, available on information and belief as of May 12, 2020; retrieved on Aug. 17, 2021.

Knoebel Industrial 5-Tier Bookcase Book Shelf, available at https://www.amazon.com/Knoebel-Industrial-Bookcase-Storage-Adjustable/dp/B08RZ1MXNL/ref=sr_1_469?dchild=1&m=A3P20C6SOQ47R1&marketplaceID=ATVPDKIKXODER&qid=1619560690&s=merchant-items&sr=1-469, found online on May 20, 2021; Retrieved on Jun. 8, 2021.

Knoebel Industrial 5-Tier Bookcase, retrieved from https://www.amazon.com/Knoebel-Industrial-Bookcase-Storage-Display/dp/B088GVWM5Q/ref=sr_1_778?dchild=1&m=A3P20C6SOQ47R1&marketplaceID=ATVPDKIKXODER&qid=1627316176&s=merchant-items&sr=1-778, available on information and belief as of May 12, 2020; retrieved on Aug. 17, 2021.

Knoebel Industrial 5-Tier Bookcase, retrieved from https://www.amazon.com/Knoebel-Industrial-Bookcase-Capacity-Espresso/dp/B08QCJK5PY/ref=sr_1_593?dchild=1&m=A3P20C6SOQ47R1&marketplaceID=ATVPDKIKXODER&qid=1627316088&s=merchant-items&sr=1-593, available on information and belief as of Dec. 11, 2020; retrieved on Aug. 17, 2021.

Lavish Home 4-Tier Ladder Bookshelf Freestanding Wooden Bookcase; <https://www.target.com/p/lavish-home-4-tier-ladder-bookshelf-freestanding-wooden-bookcase-gray/-/A-86057347#Ink=sametab>; Feb. 7, 2023.

Lavish Home 4-Tier Ladder Bookshelf with X-Back Frame—Freestanding Bookcase; <https://www.target.com/p/lavish-home-4-tier-ladder-bookshelf-with-x-back-frame-freestanding-bookcase-gray/-/A-86057350#Ink=sametab>; retrieved on Feb. 7, 2023.

LuxenHome 2 Piece Dark Brown Wood Bookcase and Bench Set; <https://www.cymax.com/LuxenHome-2-Piece-Dark-Brown-Wood-Bookcase-and-Bench-Set-2397542-PKG.htm> ; Found online on Nov. 12, 2021; retrieved on Dec. 16, 2021.

LuxenHome 2 Piece Wood and Metal Bookcase Set; <https://www.walmart.com/ip/LuxenHome-2-Piece-Wood-and-Metal-Bookcase-Set/784076958> ; Found online on Nov. 12, 2021; retrieved on Dec. 16, 2021.

LuxenHome 4-Shelf Modern Bookcase, Wood Ladder Book Shelf with Industrial Metal Frame, Corner Etagere for Living Room Bedroom Office, 58 inch, Light-Oak; https://www.amazon.com/Winsome-House-LuxenH%C3%B6me-X-Sided-Bookcase/dp/B07VZTSDX4/ref=sr_1_409?dchild=1&m=ADLW6LFQJCSW&marketplaceID=ATVPDKIKXODER&qid=1633737929&s=merchant-items&sr=1-409&th=1 ; Found online on Nov. 12, 2021; retrieved on Dec. 16, 2021.

LuxenHome 58.3 in. Black/Beige Metal 4-shelf Ladder Bookcase with Open Back; https://www.homedepot.com/p/LuxenHome-58-3-in-Black-Beige-Metal-4-shelf-Ladder-Bookcase-with-Open-Back-WHIF579/312275723?&irgwc=1&cm_mmc=af-ir-33720-459920-RealSimple&clickid=X7TQwCxCjTxyITTSw1%3A2sxUYiUkBXI0yhuTroQs0 ; Found online on Nov. 12, 2021; retrieved on Dec. 16, 2021.

LuxenHome 67in. H 4-Tier Wood Bookcase, Modern Wide Book Shelf with Metal Frame, Side Shelf Etagere for Living Room Bedroom Office, 67 inch, Woodgrain/Black ; https://www.amazon.com/Winsome-House-LuxenH%C3%B6me-66-5in-Bookcase/dp/B08D6Y6Y6B?ref=ast_sto_dp&th=1 ; Found online on Nov. 12, 2021 ; retrieved on Dec. 16, 2021.

LuxenHome Walnut Wood Finish X-Frame Metal Wide Bookcase; <https://www.cymax.com/Luxen-Home-Walnut-Wood-Finish-Wide-Bookcase-WHIF1345.htm> ; Found online on Nov. 12, 2021; retrieved on Dec. 16, 2021.

Lynise 47.44" Console Table; <https://www.wayfair.com/furniture/pdp/17-stories-lynise-47-44-console-table-w008380560.html?pid=1039905083>; retrieved on Aug. 25, 2022.

Manchester Fireplace TV Console, image post date Dec. 17, 2015, site visited Aug. 8, 2016, (online), <<http://www.walmart.com/ip/Manchester-Media-Fireplace-Stand-for-TV-s-up-to-70/46360223>. Media Console with Electric Fireplace, image post date Dec. 6, 2015, site visited Aug. 8, 2016, (online), <<http://www.overstock.com/Home-Garden/Media-Console-with-Electric-Fireplace-in-Barnwood/10309735/product.html?recset=05953330-aaal-4640-a796f225c2f8176d&refcld=MRISGBB2MZGZXYKK4EFV125H6Q&recalg=809,828,512&recidx=1#reviews>.

Metal Coffee Table; <https://www.overstock.com/Home-Garden/11/42-metal-Coffee-Table-42-x-24-x-18h/15951452/product.html> Retrieved on Nov. 13, 2018.

Middlebrook, posted Mar. 20, 2021 [online], [retrieved Jun. 23, 2023]. Retrieved from internet, <https://www.overstock.com/Home-Garden/Silver-Orchid-4-Drawer-Dresser-with-Gold-Base/33129473/product.html?refcld=LPNCNF3ZZSHINSSBGXZ> (Date :2023) (Year:2021).

Modem Two-Tone Writing Desk; <https://www.overstock.com/Home-Garden/44-Modern-Two-Tone-Writing-Desk/19684325/product.html> Retrieved on Nov. 13, 2018.

Modern Glam, posted Jun. 30, 2021 [online], [retrieved Jun. 23, 2023]. Retrieved from internet, <https://jane.com/deal/1984597/modern-glam-4-drawer-dresser-with-gold-legs> (Date:2023) (Year: 2021).

Monet Fireplace; Canadian Tire Company website: <http://www.canadianfire.ca/en/pdp/monet-fireplace-0643572p.html>; retrieved on Dec. 21, 2016.

Nelson Media Cabinet; <https://www.franceandson.com/collections/storage-shelving-media-cabinets/products/nelson-media-cabinet36051> ; Retrieved on May 7, 2019.

Non-Final Office Action received for U.S. Appl. No. 29/611,962 mailed on Feb. 25, 2019.

Notice of Allowance for U.S. Appl. No. 29/699,085; mailed on Feb. 9, 2021.

Notice of Allowance for U.S. Appl. No. 29/768,124; mailed Apr. 20, 2023.

Notice of Allowance received for U.S. Appl. No. 29/611,962 mailed on Jan. 6, 2020.

Notice of Allowance received for U.S. Appl. No. 29/634,903 mailed on Apr. 10, 2020.

(56)

References Cited

OTHER PUBLICATIONS

Notice of Allowance received for U.S. Appl. No. 29/654,935, mailed on Jun. 30, 2020.

Notice of Allowance received for U.S. Appl. No. 29/654,941, mailed on Dec. 30, 2019.

Notice of Allowance received for U.S. Appl. No. 29/699,073 mailed on Sep. 16, 2020.

Notice of Allowance received for U.S. Appl. No. 29/743,403 mailed on Aug. 17, 2021.

Office Action received for Canadian Patent Application No. 200907, mailed on Jun. 7, 2022, 2 pages.

Office Action received for U.S. Appl. No. 29/634,903 mailed on Dec. 23, 2019.

Office Action received for U.S. Appl. No. 29/654,935, mailed on Apr. 30, 2020.

Office Action received for U.S. Appl. No. 29/698,929 mailed on Dec. 14, 2020.

Othin 66.875" Hx31.5" W Steel Etagere Bookcase; <https://www.wayfair.com/furniture/pdp/gracie-oaks-othin-etagere-bookcase-w002971577.html> ; Found online on Nov. 12, 2021; retrieved on Dec. 16, 2021.

Restriction Requirement received for U.S. Appl. No. 29/654,941 mailed on Sep. 25, 2019.

Rustic Style 31 Inches Metal TV Stand With Wire Mesh Doors Cabinet, Black; <https://casagear.com/products/rustic-style-31-inches-metal-tv-stand-with-wire-mesh-doors-cabinet-black>; May 14, 2019. Sauder Pacific, posted Dec. 1, 2018 [online], [retrieved Jun. 23, 2023]. Retrieved from internet, https://www.amazon.com/dp/B08WJHGHRP/ref=sppa_dk_detail_8?psc=1&pf_rd_p=0d1092dc-81bb-493 (Date: 2023) (Year: 2021).

Saunder, posted Nov. 30, 2019 [online], [retrieved Jun. 23, 2023]. Retrieved from internet, [https://www.amazon.com/Sauder-418073-County-Drawer-Finish/dp/B00XK276C0/ref=\(Date:2023\)\(Year:2021\)](https://www.amazon.com/Sauder-418073-County-Drawer-Finish/dp/B00XK276C0/ref=(Date:2023)(Year:2021)). Selene, posted Apr. 16, 2021 [online], [retrieved Jun. 23, 2023]. Retrieved from internet, <https://www.wayfair.com/furniture/pdp/sand-stable-selene-3-drawer-nightstand-wo04866744.html?piid=88187410> (Date: 2023) (Year: 2021).

Shahoo 47 Inch Industrial Sofa Table with Storage Shelf Wood, Rustic Farmhouse Entryway Console with 3-Tier for Hallway, Living Room, White and Beige; <https://www.amazon.com/Shahoo-Industrial-Storage-Farmhouse-Entryway/dp/B09Z2W1WM2>; retrieved on Aug. 25, 2022.

Sideboard; <https://www.allmodern.com/furniture/odo/sideboard-sct11710.html>; Retrieved on May 14, 2019.

Skjalm 54" Hx24" W Metal Etagere Bookcase; <https://www.wayfair.com/furniture/pdp/gracie-oaks-industrial-bookshelf-with-4-shelves-and-open-metal-frame-silver-and-gray-w000357886.html>; Found online on Nov. 12, 2021; retrieved on Dec. 16, 2021.

Slumberland, posted Jun. 23, 2018 [online], [retrieved Jun. 23, 2023]. Retrieved from internet, [https://www.slumberland.com/p/san-mateo-nightstand/SanMateoNightstand.html\(Date:2023\)\(Year:2018\)](https://www.slumberland.com/p/san-mateo-nightstand/SanMateoNightstand.html(Date:2023)(Year:2018)). Suspend II Media Console; <https://www.cb2.com/suspend-ii-media-console/s523915>; Retrieved on May 14, 2019.

Tuk Cabinet; <https://blackroosterdecor.com/collections/storage/products/tuk-cabinet> ; Retrieved on May 14, 2019.

TV and Media Consoles, image post date Sep. 21, 2013, site visited Oct. 26, 2016, (online), <<http://web.archive.org/web/20130921074219/http://www.lectricfireplacesdirect.com/Gallery/tv-and-media-consoles.html>>.

Tv Stand With Fireplace, image post date Sep. 12, 2015, site visited Aug. 8, 2016, (online), <<https://www.tineye.com/search/77be8934bf07249cbb245c8ea0f19199437b185/>>.

U.S. Appl. No. 29/699,085, filed Jul. 23, 2019, Davis.

U.S. Application Filed on Feb. 2, 2022, by Naylor, U.S. Appl. No. 29/825,554.

U.S. Application Filed on Jan. 21, 2022, by Naylor, U.S. Appl. No. 29/824,076.

U.S. Application Filed on Jan. 23, 2019, by Davis, U.S. Appl. No. 29/677,722.

U.S. Application Filed on Jan. 23, 2019, by Davis, U.S. Appl. No. 29/677,755.

U.S. Application Filed on Jan. 23, 2019, by Davis, U.S. Appl. No. 29/677,761.

U.S. Application Filed on Jan. 25, 2018, by Davis, U.S. Appl. No. 29/349,903.

U.S. Application Filed on Jul. 12, 2018, by Davis, U.S. Appl. No. 29/656,492.

U.S. Application Filed on Jul. 12, 2018, by Davis, U.S. Appl. No. 29/656,497.

U.S. Application Filed on Jul. 12, 2018, by Davis, U.S. Appl. No. 29/656,499.

U.S. Application Filed on Jul. 21, 2020, by Packer, U.S. Appl. No. 29/743,403.

U.S. Application Filed on Jun. 25, 2021, by Duhadway, U.S. Appl. No. 29/796,678.

Notice of Allowance for U.S. Appl. No. 29/768,124; sent Apr. 20, 2023.

Office Action for U.S. Appl. No. 29/825,543; mailed Apr. 25, 2023.

U.S. Application Filed on Oct. 5, 2021, by Duhadway, U.S. Appl. No. 29/810,476.

U.S. Appl. No. 29/654,930, filed Jun. 28, 2018 by Davis.

U.S. Appl. No. 29/654,952, filed Jun. 28, 2018 by Davis.

U.S. Appl. No. 29/656,486, filed Jul. 12, 2018 by Davis.

U.S. Appl. No. 29/677,738, filed Jan. 23, 2019 by Davis.

U.S. Patent Application Filed on Jan. 23, 2019 by Davis, U.S. Appl. No. 29/677,723.

U.S. Patent Application Filed on Jan. 23, 2019 by Davis, U.S. Appl. No. 29/677,724.

U.S. Patent Application Filed on Jan. 25, 2018 by Davis, U.S. Appl. No. 29/634,946.

U.S. Patent Application Filed on Jan. 25, 2018, by Davis, U.S. Appl. No. 29/634,889.

U.S. Patent Application Filed on Jan. 25, 2018, by Davis, U.S. Appl. No. 29/634,914.

U.S. Patent Application Filed on Jul. 12, 2018 by Davis, U.S. Appl. No. 29/656,485.

U.S. Patent Application Filed on Jul. 12, 2018, by Davis, U.S. Appl. No. 29/656,479.

U.S. Patent Application Filed on Jul. 12, 2018, by Davis, U.S. Appl. No. 29/656,489.

U.S. Patent Application Filed on Jul. 27, 2017, by Davis, U.S. Appl. No. 29/611,962.

U.S. Patent Application Filed on Jun. 28, 2018 by Davis, U.S. Appl. No. 29/654,936.

U.S. Patent Application Filed on Jun. 28, 2018 by Davis, U.S. Appl. No. 29/654,950.

U.S. Patent Application Filed on Jun. 28, 2018, by Davis, U.S. Appl. No. 29/654,935.

U.S. Patent Application Filed on Jun. 28, 2018, by Davis, U.S. Appl. No. 29/654,941.

U.S. Patent Application Filed on Mar. 7, 2022, by Duhadway, U.S. Appl. No. 29/829,679.

U.S. Patent Application filed on Feb. 2, 2022 By Naylor, U.S. Appl. No. 29/766,533.

U.S. Patent Application filed on Feb. 2, 2022 By Naylor, U.S. Appl. No. 29/766,543.

U.S. Patent Application filed on Feb. 3, 2022 By Duhadway, U.S. Appl. No. 29/766,664.

U.S. Patent Application filed on Feb. 3, 2022 By Duhadway, U.S. Appl. No. 29/766,668.

U.S. Patent Application filed on Feb. 8, 2022 By Naylor, U.S. Appl. No. 29/766,972.

U.S. Patent Application filed on Jan. 15, 2020 By Davis, U.S. Appl. No. 29/766,725.

U.S. Patent Application filed on Jan. 17, 2020 By Davis, U.S. Appl. No. 29/766,169.

U.S. Patent Application filed on Jan. 23, 2019 By Davis, U.S. Appl. No. 29/766,754.

U.S. Patent Application filed on Jan. 26, 2021 By Duhadway, U.S. Appl. No. 29/766,920.

U.S. Patent Application filed on Jan. 26, 2021 By Duhadway, U.S. Appl. No. 29/766,921.

(56)

References Cited

OTHER PUBLICATIONS

U.S. Patent Application filed on Jan. 26, 2021 By Duhadway, U.S. Appl. No. 29/766,926.

U.S. Patent Application filed on Jan. 27, 2021 By Naylor, 29/766,124.

U.S. Patent Application filed on Jul. 22, 2019 By Davis, U.S. Appl. No. 29/766,929.

U.S. Patent Application filed on Jul. 22, 2019 By Davis, U.S. Appl. No. 29/766,933.

U.S. Patent Application filed on Jul. 22, 2019 By Davis, U.S. Appl. No. 29/766,934.

U.S. Patent Application filed on Jul. 22, 2020 By Packer, U.S. Appl. No. 29/766,596.

U.S. Patent Application filed on Jul. 22, 2020 By Packer, U.S. Appl. No. 29/766,597.

U.S. Patent Application filed on Jul. 23, 2019 By Davis, U.S. Appl. No. 29/766,073.

U.S. Patent Application filed on Jul. 27, 2017 By Davis, U.S. Appl. No. 29/611,963.

U.S. Patent Application filed on Jul. 27, 2021 By Duhadway, 29/766,171.

U.S. Patent Application filed on Mar. 9, 2022 By Naylor, U.S. Appl. No. 29/766,013.

U.S. Patent Application filed on Mar. 9, 2022 By Naylor, U.S. Appl. No. 29/766,020.

U.S. Patent Application filed on Mar. 21, 2022 By Naylor, U.S. Appl. No. 29/766,313.

W. Trends Industrial 60" Media Console Table Storage Bookcase; <https://www.bjs.com/product/w-trends-industrial-60-media-console-table-storage-bookcase---dark-walnut/3000000000001633628>; retrieved on Aug. 25, 2022.

Walker Edison Sideboard, posted Nov. 19, 2019 [online], [retrieved Jun. 20, 2023]. Retrieved from internet, https://www.amazon.com/dp/8081R313ZH/ref=twister_B0BHVBT3BF?_encoding=UTF8&th=1 (Date:2023) (Year: 2019).

Walker Edison TV Stand with Fireplace Insert, image post date Jul. 31, 2015, site visited Aug. 8, 2016, (online), <<https://www.amazon.com/Walker-Edison-Fireplace-Insert-Espresso/dp/B00-PN0NTAK>>.

Welwick, posted Nov. 9, 2020 [online], [retrieved Jun. 20, 2023]. Retrieved from internet, <https://www.dealnews.com/products/Welwick-Designs-57-Classic-Solid-Wood-6-Drawer-Dresser/156736.html> (Date:2023) (Year: 2020).

Whalen Media Fireplace Console for TVs up to 70 Gray" Nov. 24, 2015, walmart.com, site visited Mar. 6, 2018 <<https://www.walmart.com/ip/Whalen-Media-Fireplace-Console-for-TVs-up-to-70-Gray/54189794>> (Year: 2015).

Wigington TV Stand for TVs up to 60"; <https://www.allmodern.com/furniture/pdp/wigington-tv-stand-for-tvs-up-to-60-golv3670.html?piid> ; Retrieved on May 7, 2019.

Winsome Wood Avalon A-Frame Shelf; <https://www.shop.com/Avalon+A+Frame+Shelf+-+1866803103-p+.xhtml> ; Found online on Nov. 12, 2021; retrieved on Dec. 16, 2021.

Woven Paths Solid Wood Storage Console Table, White/Reclaimed Barnwood; <https://www.walmart.com/ip/Woven-Paths-Solid-Wood-Storage-Console-Table-White-Reclaimed-Barnwood/332506764?wmlspartner=wlpa&selectedSellerId=1172>; retrieved on Aug. 25, 2022.

Eden Light Dresser, available Dec. 29, 2021 [online], [retrieved Dec. 29, 2023], Retrieved from internet, <https://www.kirklands.com/product/Eden-Light-Birch-Tapered-Legs-Dresser/318082.uts> (Year: 2021).

Ivora Dresser, available Dec. 29, 2021 [online], [retrieved Dec. 29, 2023], Retrieved from internet, <https://www.target.com/p/ivora-lifted-mid-century-modern-asymmetrical-5-drawer-dresser-saracina-home/-/A-84081702> (Year: 2021).

Landon Media Console, Available Aug. 21, 2021 [online], [retrieved Nov. 14, 2023], Retrieved from internet, <https://tinyurl.com/2xkk7pr9> (Year: 2021).

Nordli Dresser, available Dec. 12, 2019 [online], [retrieved Dec. 29, 2023], Retrieved from internet, <https://www.ikea.com/us/en/p/nordli-6-drawer-dresser-white-s09384188/> (Year: 2019).

2 Drawer Nightstand by Welwick Designs, first available: Jul. 7, 2022 . homedepot.com [online], [site visited Jan. 23, 2024], Internet URL: <https://www.homedepot.com/p/Welwick-Designs-2-Drawer-Natural-Solid-Wood-Mid-Century-Modern-Nightstand-with-Tray-Top-HD9801/326814796#overlay> (Year: 2022).

4 Door Slatted Sideboard, date unavailable [online], [retrieved Jan. 17, 2024]. Retrieved from internet, <https://www.livingspaces.com/pdp-dark-natural-elm-4-door-slatted-sideboard-301117> (Year: 2024).

4 Ever Winner Farmhouse Coffee Bar Cabinet with Storage, Sideboard Storage Cabinet with Barn Doors, Coffee Bar Cabinet Accent Cabinets with Drawer for Living Room, Entryway, Dining Room, Grey Wash; <https://www.amazon.com/dp/BOBN5T7LNQ>; retrieved on Feb. 7, 2023.

Alohappy Nightstand, posted date unavailable [online], [retrieved Jan. 17, 2024]. Retrieved from internet, <https://www.amazon.com/Alohappy-Nightstand-Mid-Century-Storage-Livingroom/dp/B0C77HX7D1?th=1> (Year: 2024).

BR6DRLEEDR Assembly Instructions, revised Nov. 2021 [online], [retrieved Feb. 2, 2024]. Retrieved from internet, https://www.bedbathandbeyond.com/downloads/pdf/1399296687_2989264f-25cf-33e0-a479-9947746acf00.pdf (Year: 2021).

BR9DRLEEDR Assembly Instructions, revised Nov. 2021 [online], [retrieved Feb. 2, 2024]. Retrieved from internet, https://www.bedbathandbeyond.com/downloads/pdf/1399212607_a237164c-c132-35e8-b504-50d0433270fd.pdf (Year: 2021).

Final Office Action received for U.S. Appl. No. 29/884,258, mailed on May 29, 2024, 7 pages.

Fryar TV Stand; Wayfair.com; found online Apr. 21, 2021; retrieved May 4, 2021 (online); <https://www.wayfair.com/furniture/pdp/gracie-oaks-fryar-tv-stand-for-tvs-up-to-75-w001713808.html>.

Garcon Dresser, available Oct. 18, 2022 [online], [retrieved Feb. 2, 2024]. Retrieved from internet, <https://www.wayfair.com/furniture/pdp/winston-porter-garcon-6-drawer-461-w-dresser-w009803472.html?piid=463264814> (Year: 2022).

Gheorge Nightstand by Wade Logan, first available: May 31, 2022. Wayfair.com [online], [site visited Jan. 23, 2024], Internet URL: <https://www.wayfair.com/furniture/pdp/wade-logan-gheorge-2-drawer-nightstand-w008212118.html> (Year: 2022).

Mid-Century Modern Dresser, available Nov. 22, 2022 [online], [retrieved Feb. 2, 2024]. Retrieved from internet, <https://www.avocadogreenmattress.com/products/mid-century-modern-dresser> (Year: 2022).

Newhaven 56" Sideboard, available Feb. 28, 2023 [online], [retrieved Nov. 15, 2023], Retrieved from internet, <https://www.wayfair.com/furniture/pdp/greyleigh-newhaven-56-wide-2-drawer-sideboard-w007890457.html?piid=> (Year: 2023).

Notice of Allowance received for U.S. Appl. No. 29/825,538, mailed on May 29, 2024, 5 pages.

Notice of Allowance received for U.S. Appl. No. 29/830,013, mailed on May 29, 2024, 5 pages.

Notice of Allowance received for U.S. Appl. No. 29/830,020, mailed on May 29, 2024, 5 pages.

Notice of Allowance received for U.S. Appl. No. 29/884,260, mailed on May 15, 2024, 6 pages.

Prospect Low Dresser, posted date unavailable [online], [retrieved Feb. 2, 2024]. Retrieved from internet, https://burrow.com/bedroom/dressers/prospect-6-drawer-low-dresser?utm_source=pepperjam&utm_medium=affiliate&utm_campaign=177862&clickId=4646606259 (Year: 2024).

Vintage Slat Front Dresser, posted date unavailable [online], [retrieved Jan. 17, 2024]. Retrieved from internet, https://www.1stdibs.com/furniture/storage-case-pieces/dressers/vintage-low-four-drawer-slat-front-dresser/id-f_596168/ (Year: 2024).

* cited by examiner

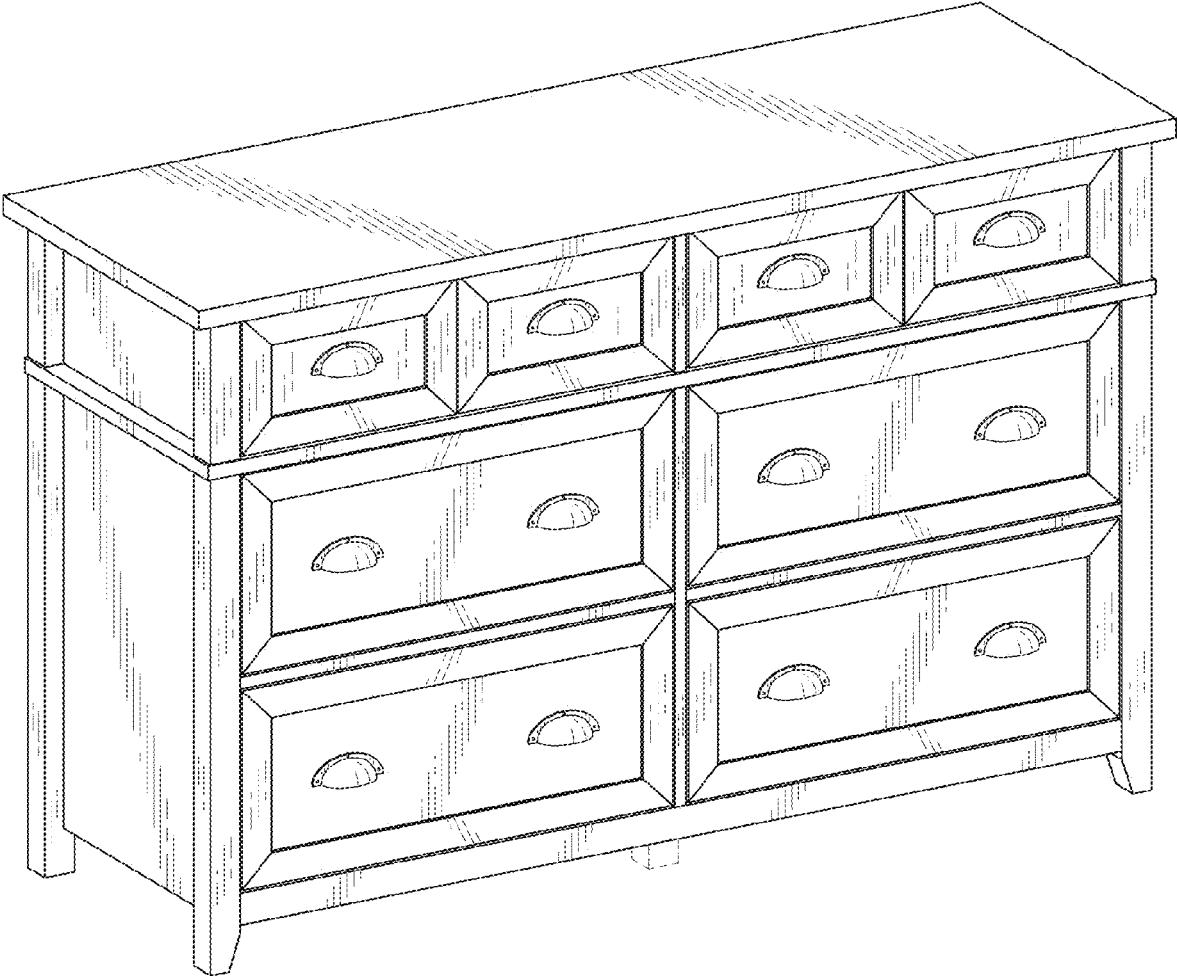

FIG. 1

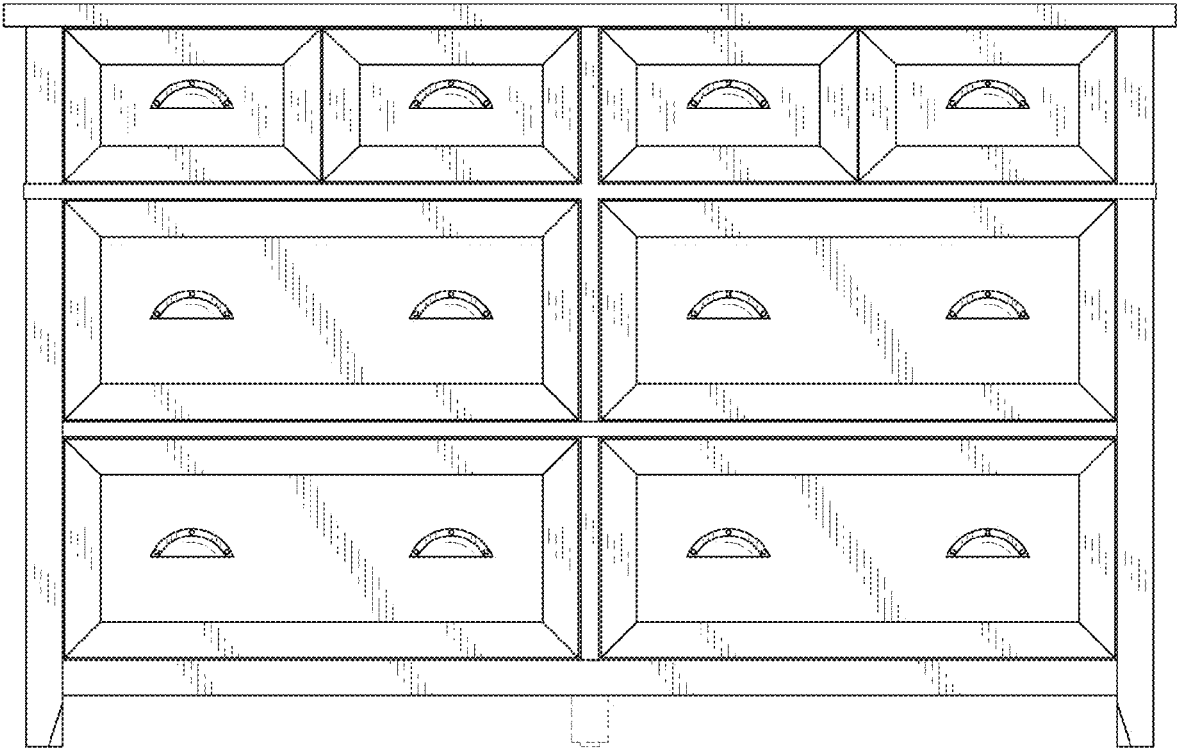

FIG. 2

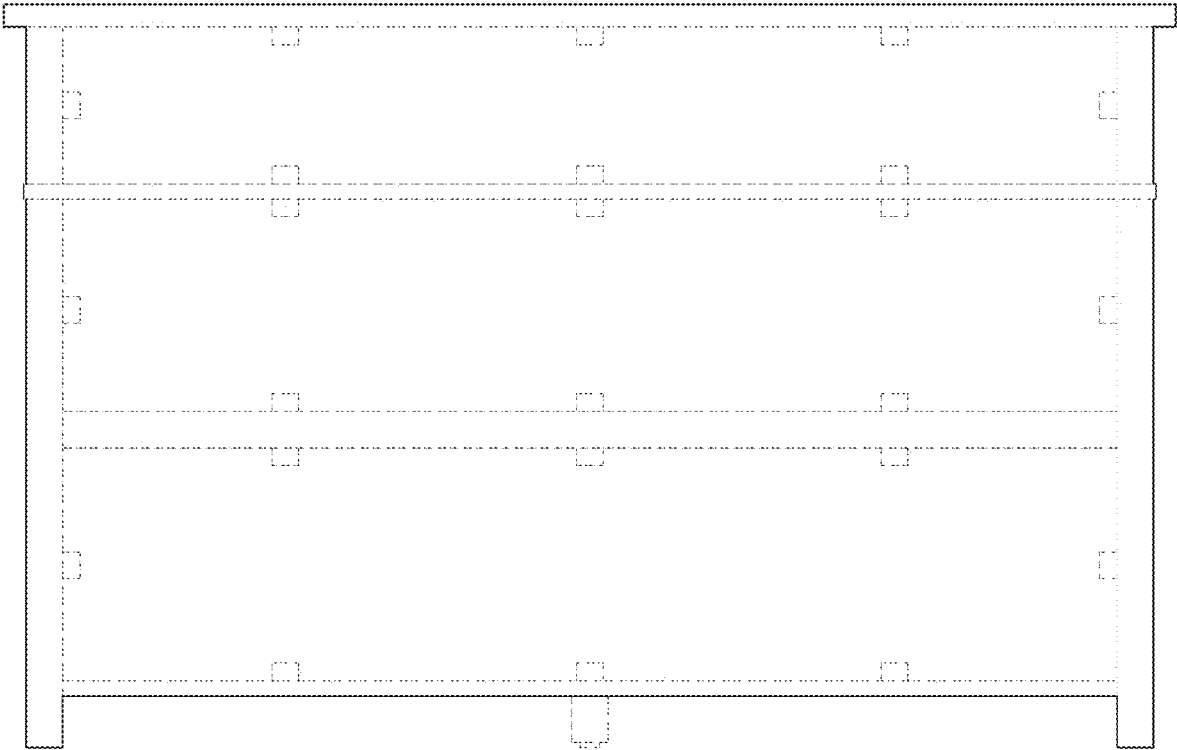

FIG. 3

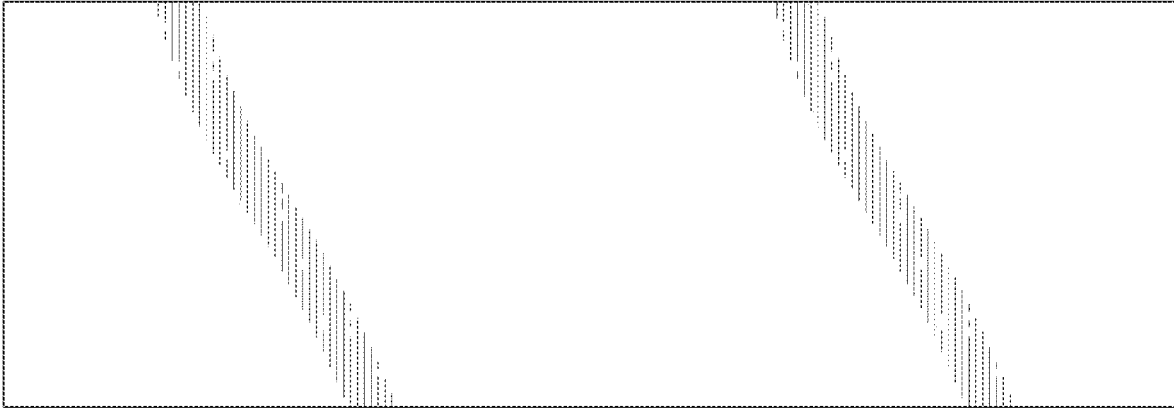

FIG. 4

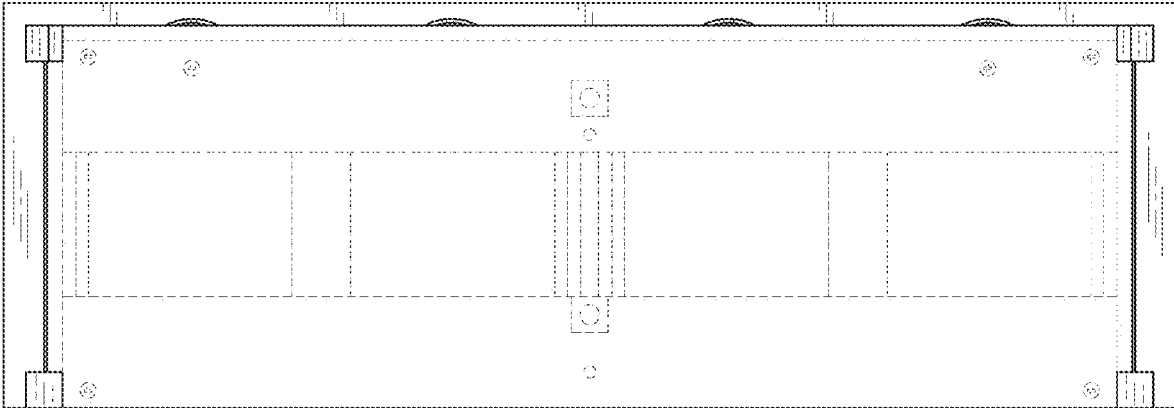

FIG. 5

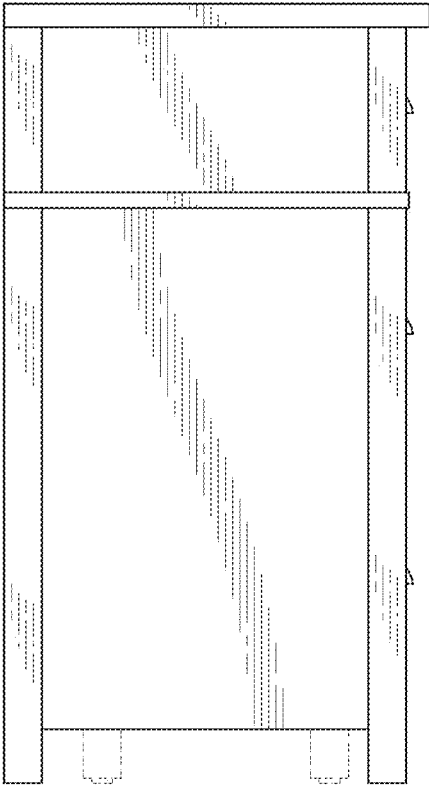

FIG. 6

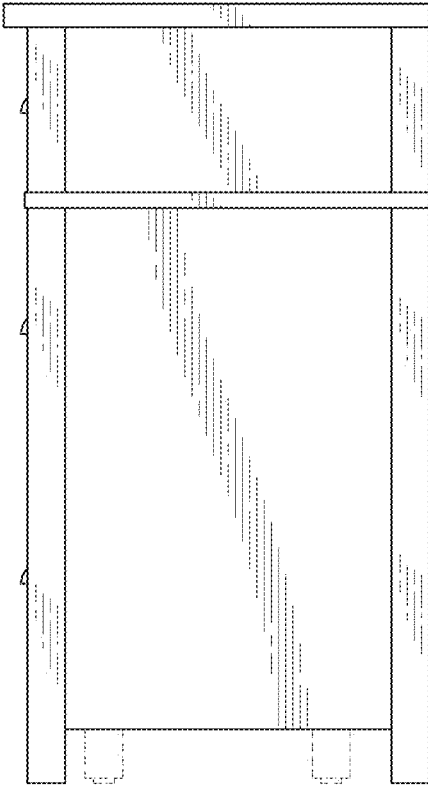

FIG. 7

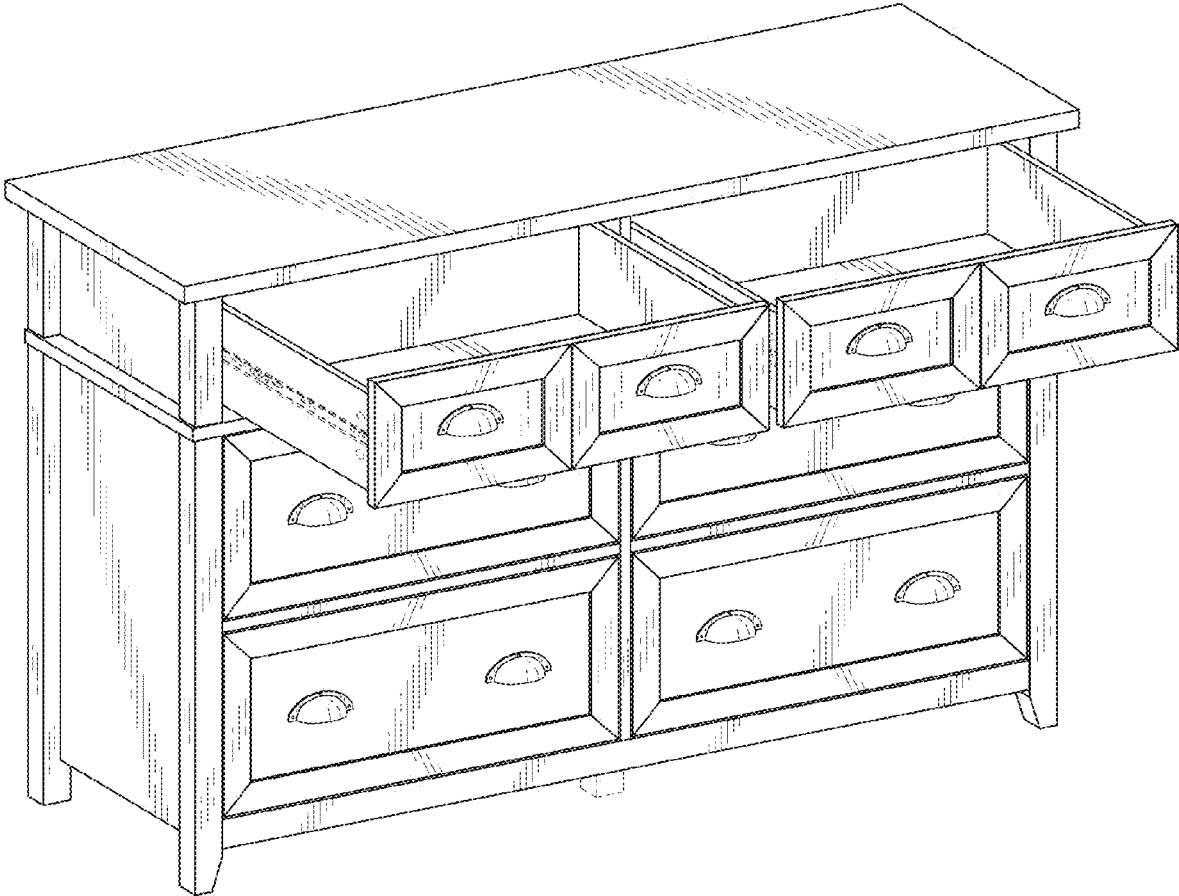

FIG. 8

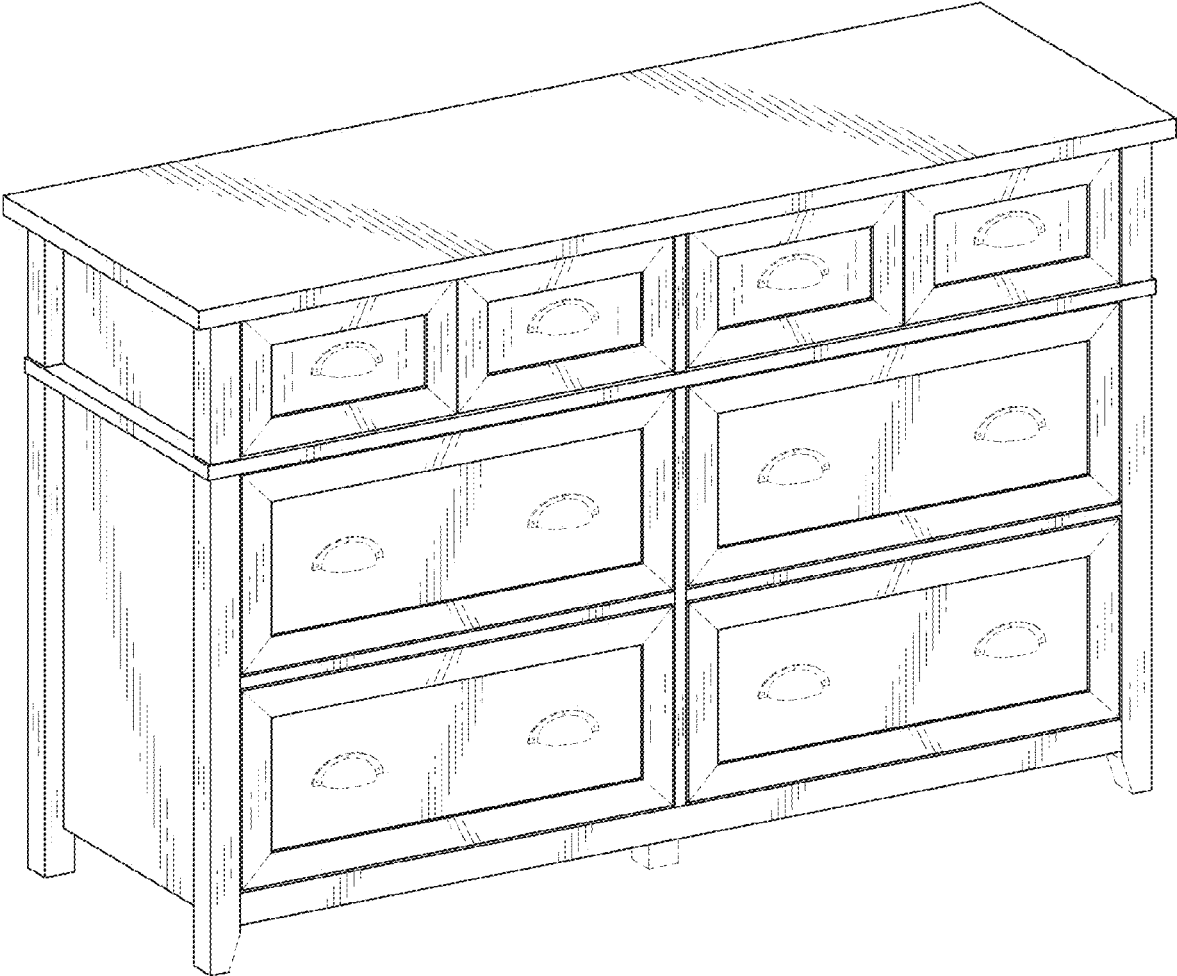

FIG. 9

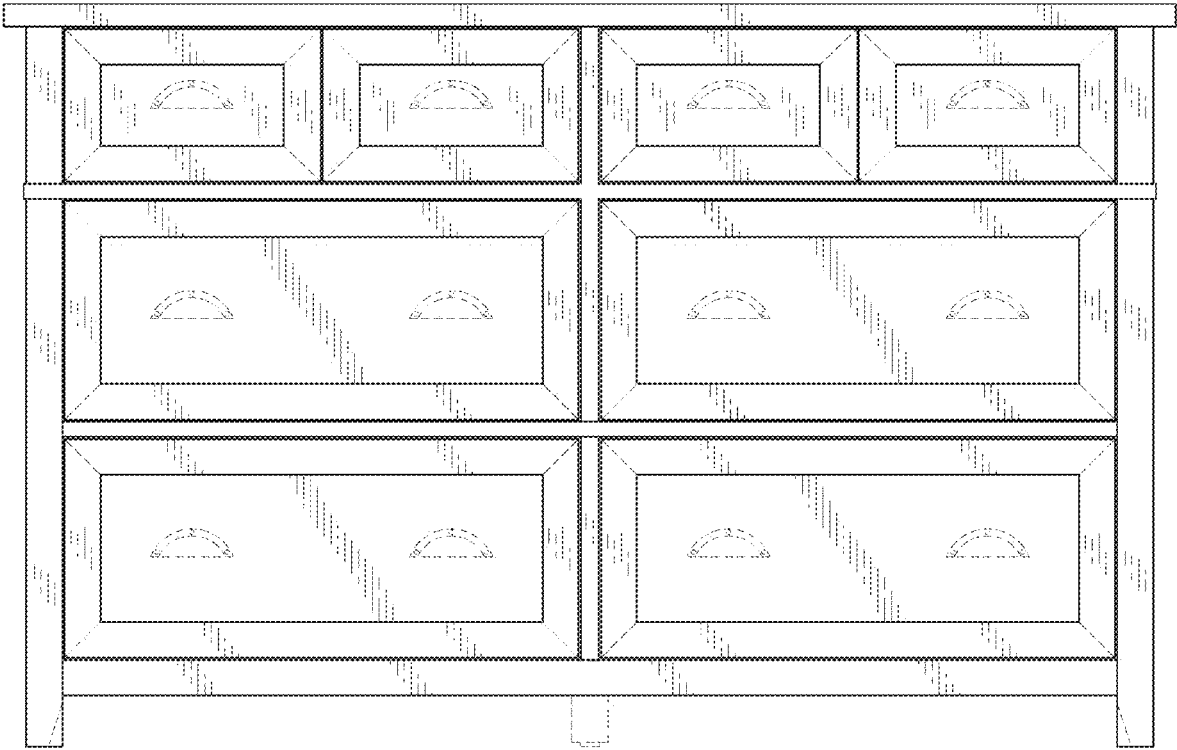

FIG. 10

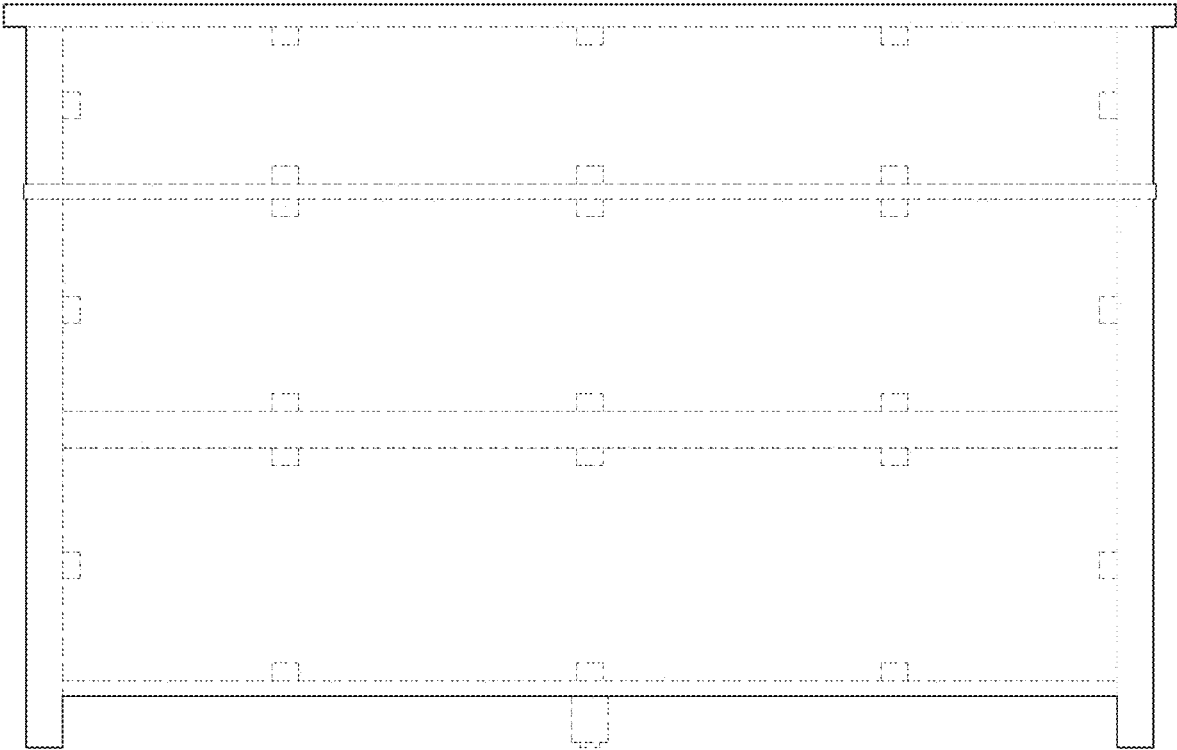

FIG. 11

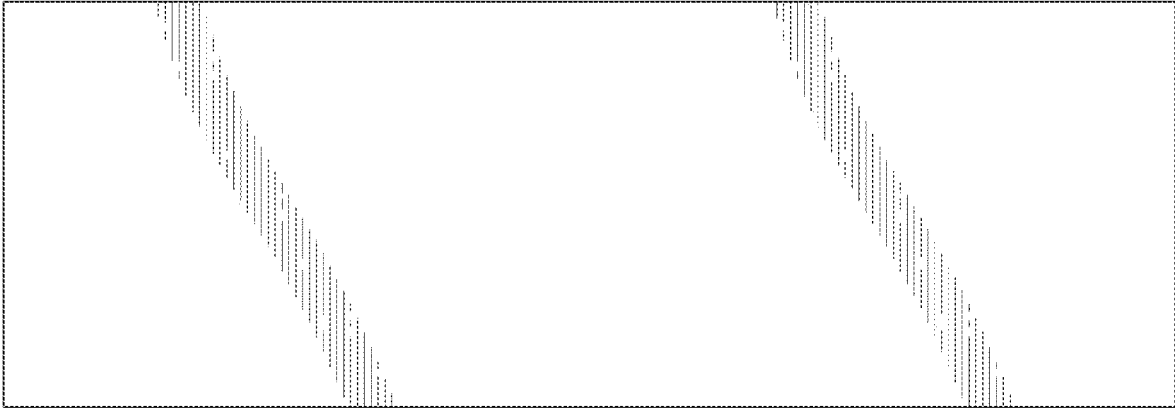

FIG. 12

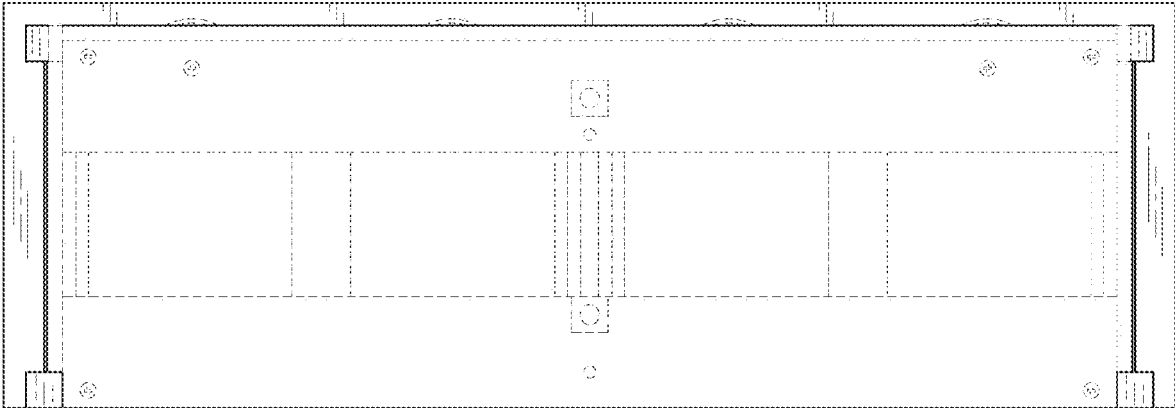

FIG. 13

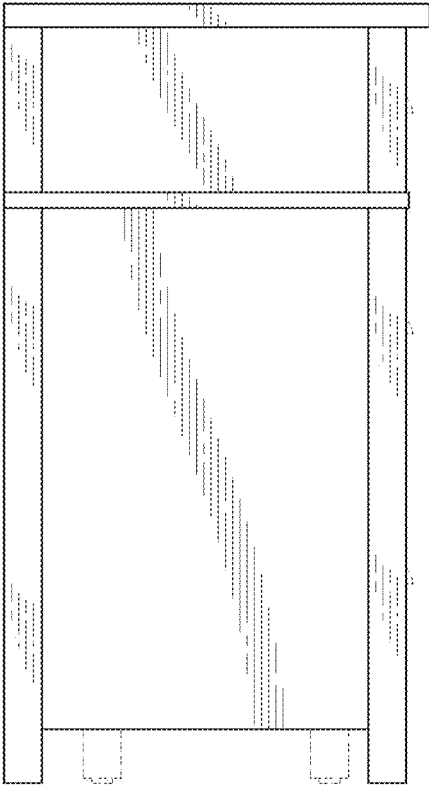

FIG. 14

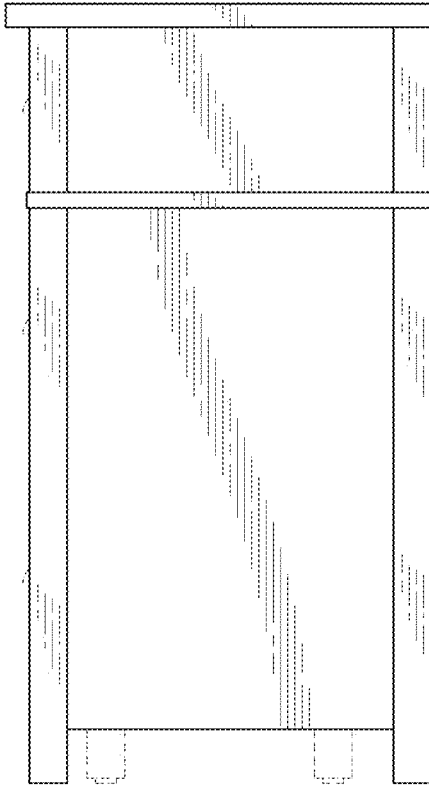

FIG. 15

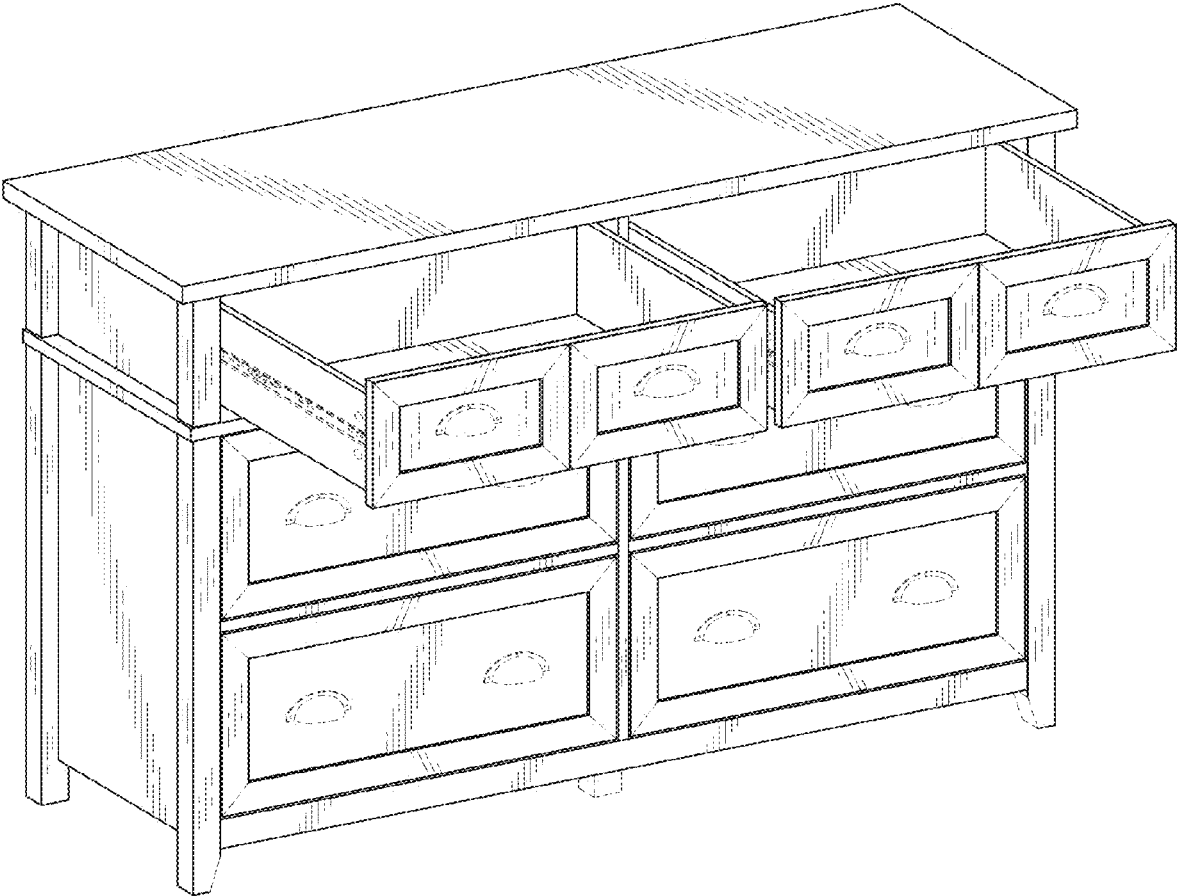

FIG. 16