



US00D406114S

United States Patent [19]

[11] **Patent Number: Des. 406,114**

Ham et al.

[45] **Date of Patent: **Feb. 23, 1999**

[54] **ELECTRONIC NOTE PAD**

D. 333,125 2/1993 Komada et al. D14/100
4,972,496 11/1990 Sklarew D14/100 X

[75] Inventors: **Soojung Ham**, Providence, R.I.;
Melinda Payne Williamson, Phoenix,
Ariz.

Primary Examiner—Freda Nunn
Attorney, Agent, or Firm—Notaro & Michalos P.C.

[73] Assignee: **A. T. Cross Company**, Lincoln, R.I.

[57] **CLAIM**

[**] Term: **14 Years**

The ornamental design for an electronic note pad, as shown and described.

[21] Appl. No.: **79,529**

[22] Filed: **Nov. 12, 1997**

[51] **LOC (6) Cl.** **14-02**

[52] **U.S. Cl.** **D14/100**

[58] **Field of Search** D14/100, 106,
D14/113, 115; D19/59, 60, 62; 345/104,
156, 173, 901, 905; 364/708.1; 178/18,
19

DESCRIPTION

FIG. 1 is a top plan view of an electronic note pad showing our new design therefore;
FIG. 2 is a bottom plan view thereof;
FIG. 3 is a front elevational view thereof;
FIG. 4 is a rear elevational view thereof;
FIG. 5 is a left side elevational view thereof;
FIG. 6 is a right side elevational view thereof; and,
FIG. 7 is a top, front, right perspective view thereof.

[56] **References Cited**

U.S. PATENT DOCUMENTS

D. 317,151 5/1991 Daly D14/100

1 Claim, 5 Drawing Sheets

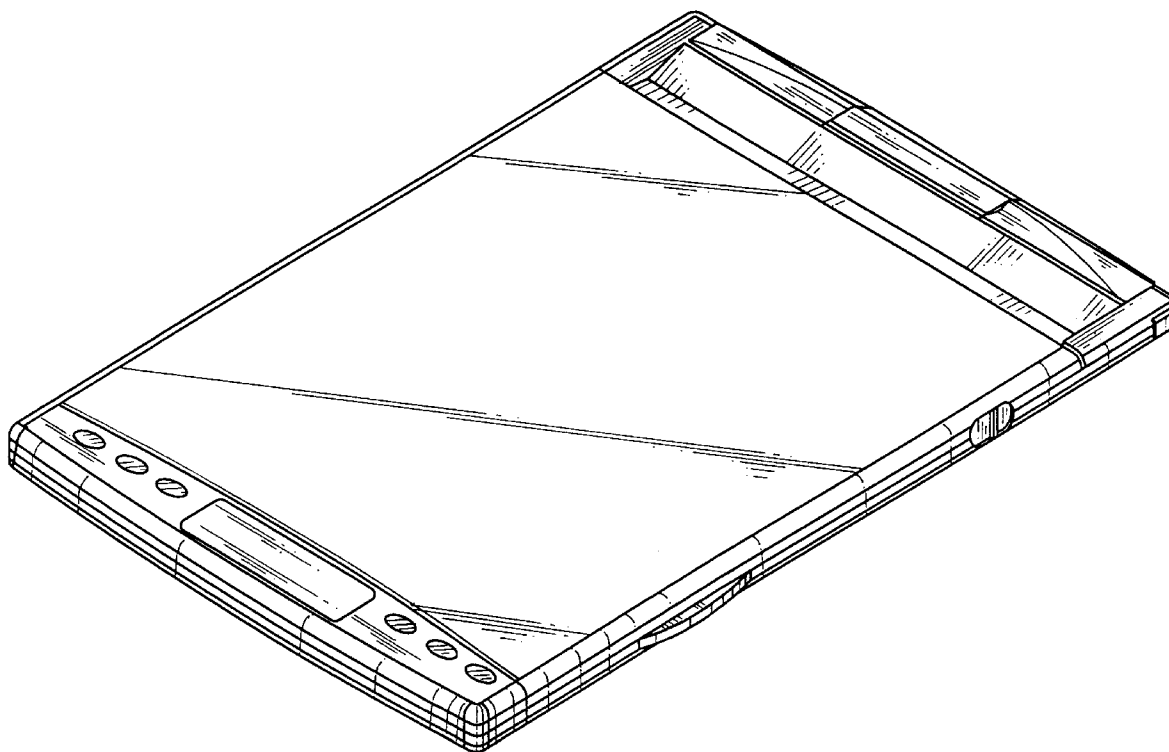

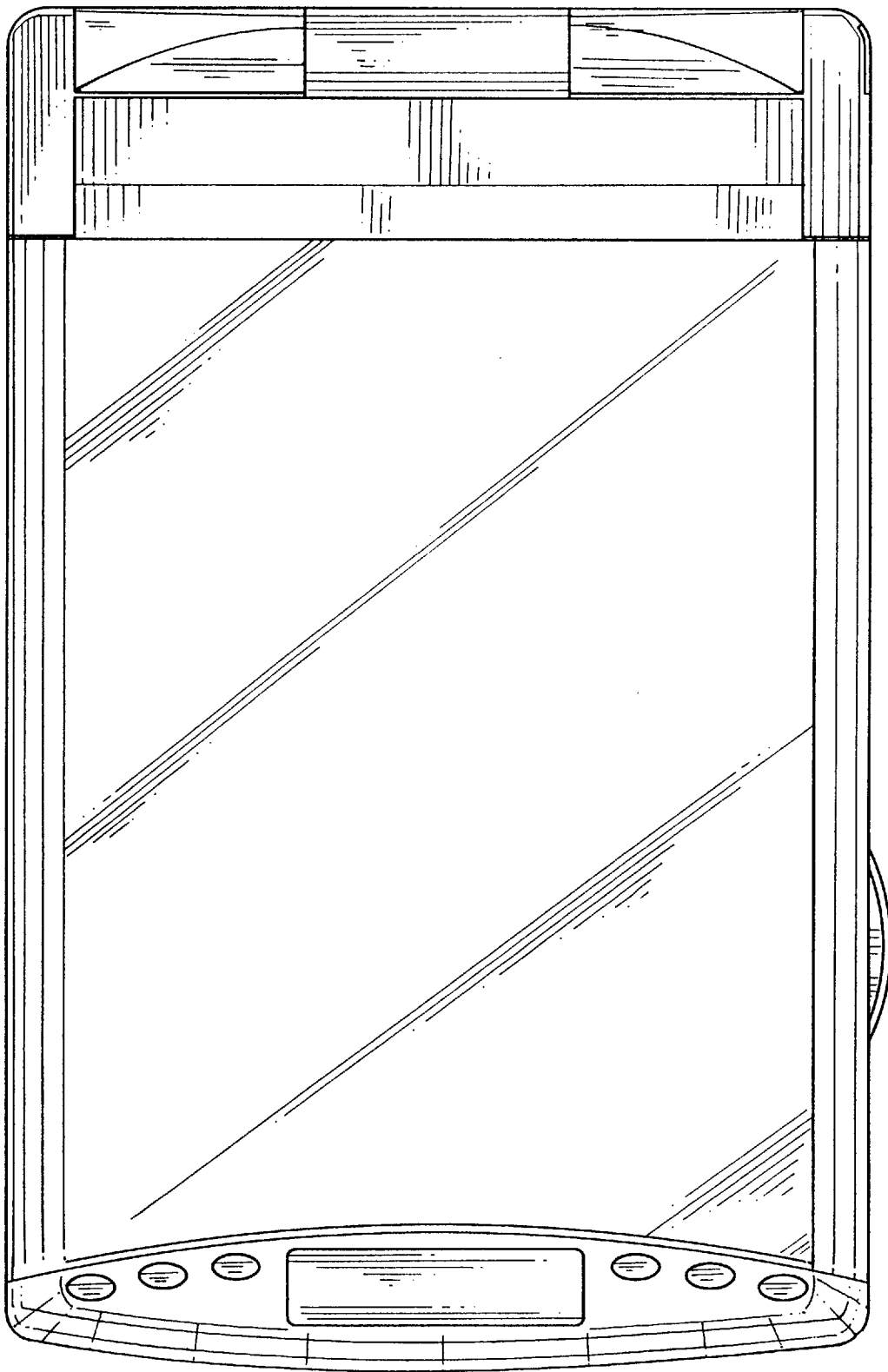

FIG. 1

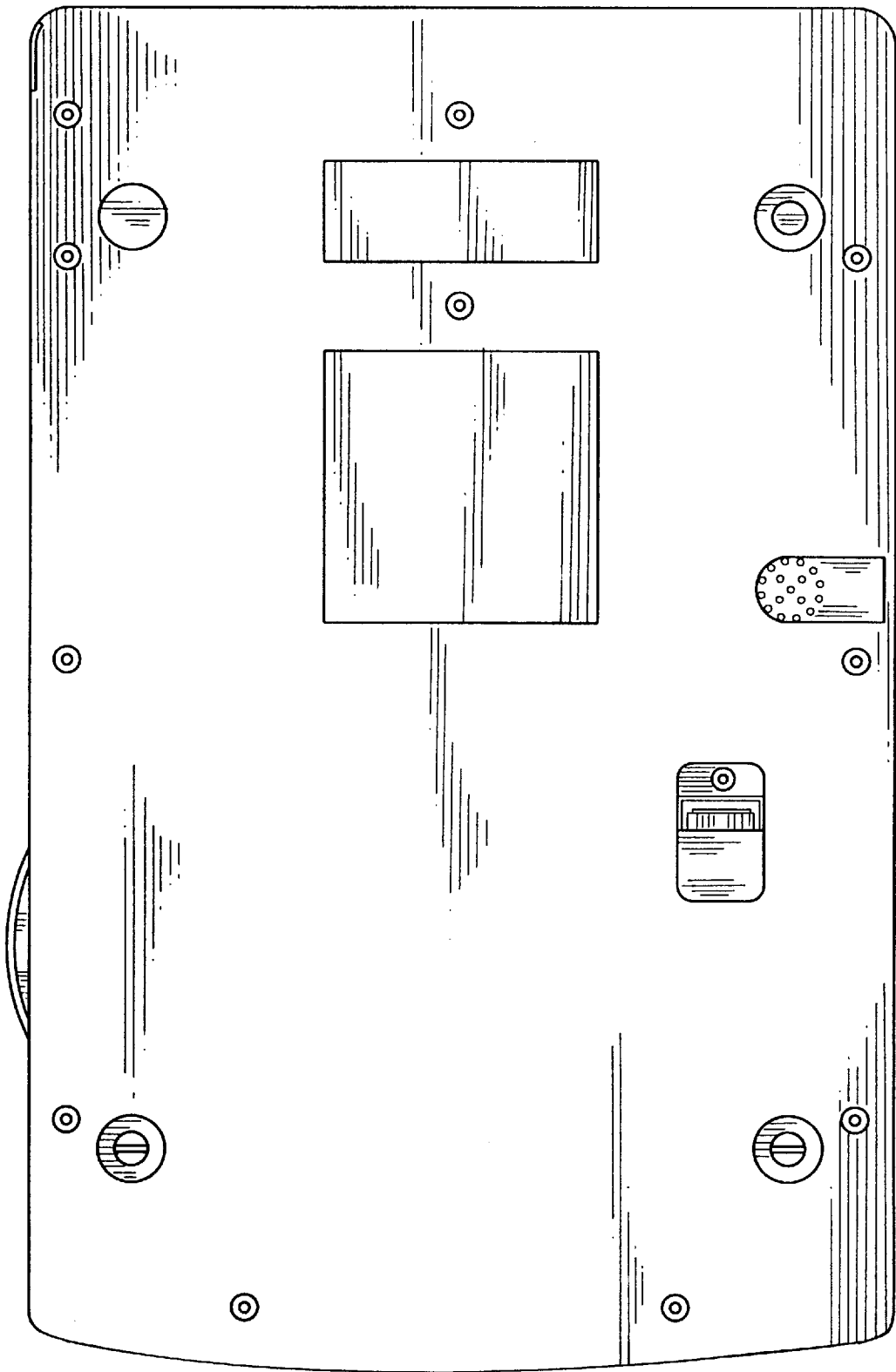

FIG. 2

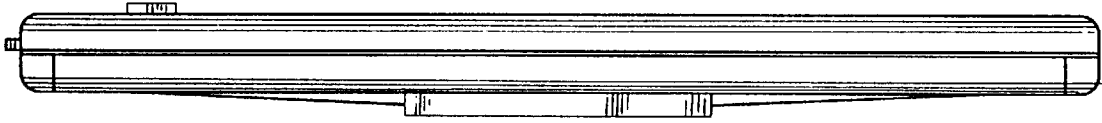

FIG. 3

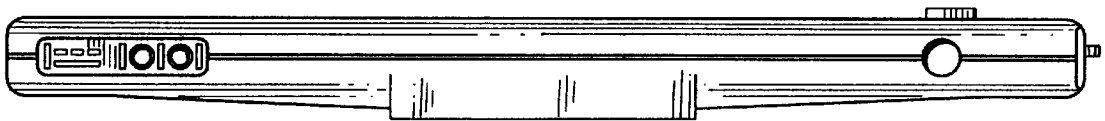

FIG. 4

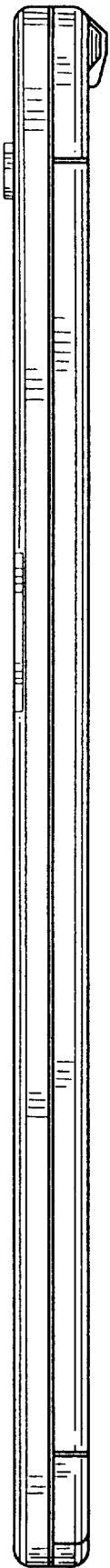

FIG. 5

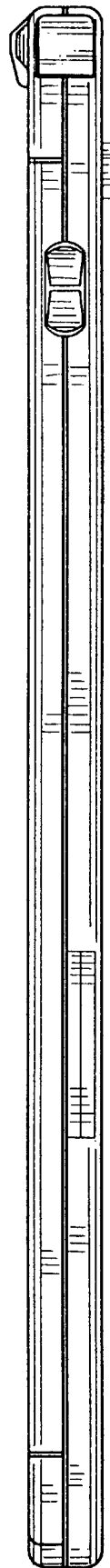

FIG. 6

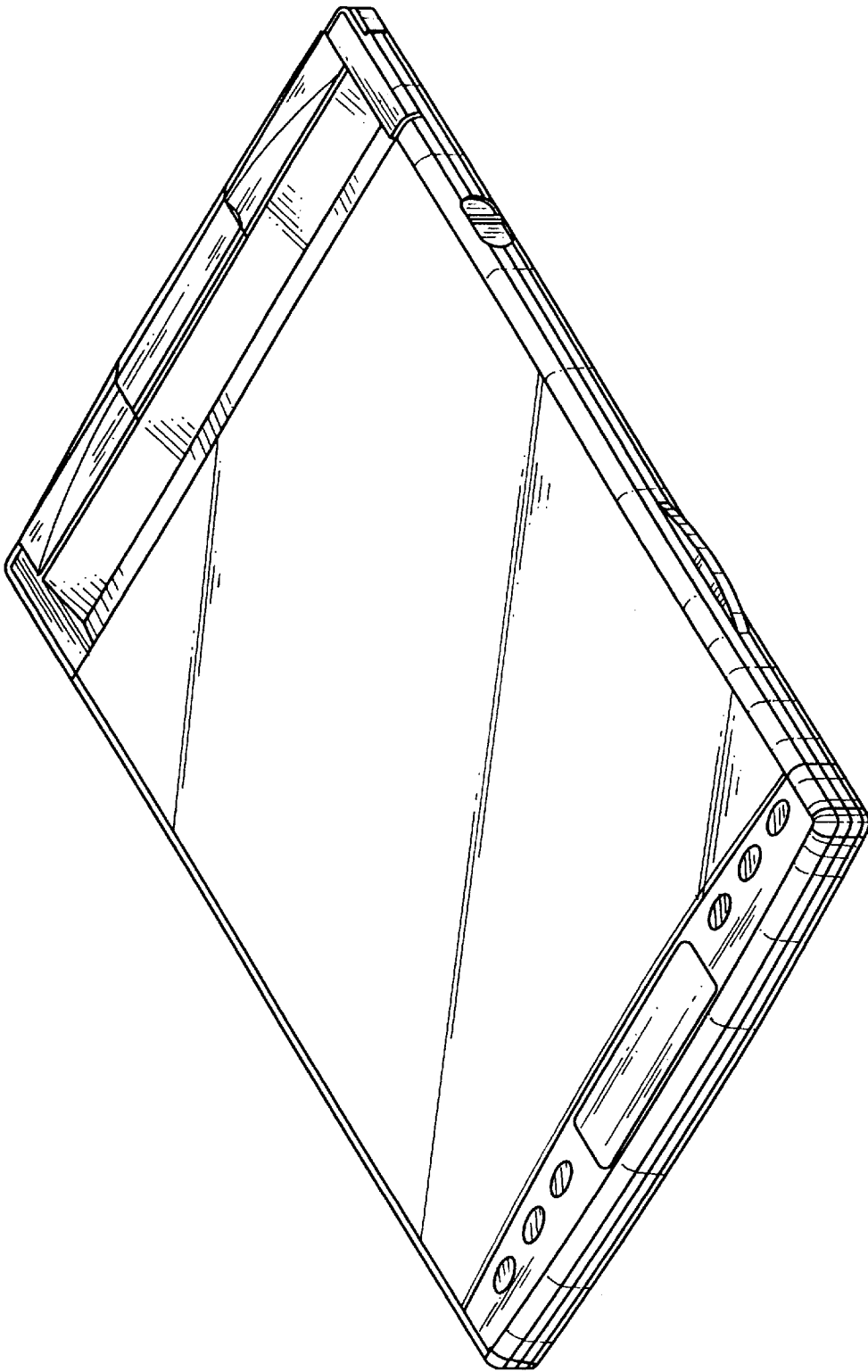

FIG. 7