



US00D662338S

(12) **United States Design Patent**  
**Arko et al.**

(10) **Patent No.:** **US D662,338 S**

(45) **Date of Patent:** **\*\* Jun. 26, 2012**

(54) **SEAT PORTION**

(75) Inventors: **Robert Peter Arko**, San Francisco, CA (US); **John R. Hamilton**, San Rafael, CA (US); **Matthew Hollingsworth**, San Francisco, CA (US)

(73) Assignee: **Steelcase Inc.**, Grand Rapids, MI (US)

(\*\*) Term: **14 Years**

(21) Appl. No.: **29/390,352**

(22) Filed: **Apr. 22, 2011**

(51) **LOC (9) Cl.** ..... **06-01**

(52) **U.S. Cl.** ..... **D6/492**

(58) **Field of Classification Search** ..... D6/334,  
D6/335, 337, 374, 379, 380, 381, 491, 492,  
D6/495, 500-502, 341; 297/118, 300.1,  
297/302.1, 311, 313, 353, 354.1, 445.1, 446.1,  
297/446.2, 447.4, 464, 465, 900, DIG. 2,  
297/DIG. 7; 5/12.1, 12.2  
See application file for complete search history.

(56) **References Cited**

**U.S. PATENT DOCUMENTS**

2,217,426	A *	10/1940	Zareko	.....	297/117
D169,911	S	6/1953	Netzer		
D170,088	S	7/1953	Hoffman		
D170,122	S	8/1953	Jorgensen		
D175,877	S	10/1955	Bartolucci		
D179,829	S	3/1957	Wilson		
2,793,685	A *	5/1957	Spitz	.....	297/411.27
D186,308	S	10/1959	Knoll		
2,965,160	A	12/1960	Knoll		
2,979,122	A	4/1961	Knoll		
2,985,892	A	5/1961	Garrigus, Sr. et al.		
2,997,724	A	8/1961	Heumann		
3,328,810	A	7/1967	Berman		
3,380,777	A	4/1968	Bennett		
3,695,690	A *	10/1972	Carson	.....	297/218.3
3,857,120	A *	12/1974	Acker	.....	5/12.1

D234,331	S *	2/1975	Rocchis	.....	D6/369
D244,069	S *	4/1977	Summer	.....	D6/371
4,188,066	A *	2/1980	Terenzoni	.....	297/440.23
D272,968	S	3/1984	Fairaizen		
4,621,381	A	11/1986	Schramek		
D329,543	S *	9/1992	Shields	.....	D6/334
D360,310	S	7/1995	Stamberg et al.		
D373,257	S *	9/1996	Hutton	.....	D6/381
D379,269	S *	5/1997	Hutton	.....	D6/334
D384,827	S	10/1997	Hutton		
D385,122	S	10/1997	Hutton		
D410,800	S *	6/1999	Gomez	.....	D6/369

(Continued)

**OTHER PUBLICATIONS**

Metropolitan Furniture Corporation. "Contract Bench". Interiors catalog. Copyright Apr. 1961.

(Continued)

*Primary Examiner* — Sandra Snapp

(74) *Attorney, Agent, or Firm* — Quarles & Brady LLP

(57)

**CLAIM**

The ornamental design for a seat portion, as shown and described.

**DESCRIPTION**

FIG. 1 is a left, top, front perspective view of a seat portion according to our new design, the bottom thereof is unseen in use;  
FIG. 2 is a top, rear perspective view from the left side thereof;  
FIG. 3 is a front elevational view thereof;  
FIG. 4 is a rear elevational view thereof;  
FIG. 5 is a left side elevational view thereof; and,  
FIG. 6 is a top plan view thereof.  
The broken line representations in the figures are for the purpose of illustrating unclaimed boundaries. The broken lines are thus not part of the claim.

**1 Claim, 3 Drawing Sheets**

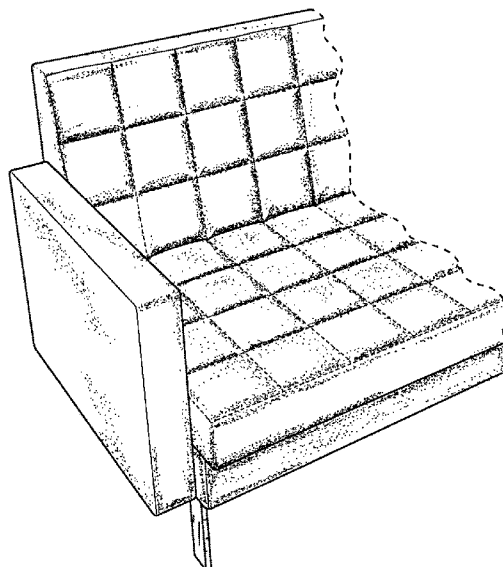

U.S. PATENT DOCUMENTS

D422,422	S	*	4/2000	Black	.....	D6/369
D429,082	S		8/2000	Desombre		
D433,824	S		11/2000	King		
D443,989	S		6/2001	Gomez		
D444,305	S		7/2001	Mourgue		
D455,281	S		4/2002	Andersen et al.		
D455,282	S		4/2002	Andersen et al.		
D473,723	S		4/2003	Pesso		
D477,152	S		7/2003	Levy		
D484,327	S		12/2003	Ricci		
D485,086	S		1/2004	Gomez		
D486,311	S	*	2/2004	Boydak	.....	D6/335
D486,652	S	*	2/2004	Nemeth	.....	D6/334
D489,188	S		5/2004	Ricci		
D490,630	S		6/2004	Pesso		
D495,153	S		8/2004	Ricci		
D495,514	S		9/2004	Ricci		
D495,892	S	*	9/2004	Ricci	.....	D6/381
D495,893	S		9/2004	Ricci		
D498,064	S		11/2004	Gomez		
D498,075	S		11/2004	Mourgue		
D498,941	S		11/2004	Ricci		
6,824,220	B1	*	11/2004	Davison	.....	297/440.14
D499,261	S		12/2004	Ricci		
D501,330	S		2/2005	Gomez		
D505,276	S		5/2005	Cronk et al.		
D511,415	S		11/2005	Pesso		
D515,334	S		2/2006	Natuzzi		
D518,654	S		4/2006	Pesso		
D527,541	S		9/2006	Natuzzi		
D533,365	S	*	12/2006	Martin	.....	D6/334
D538,054	S		3/2007	Lissoni		
D539,561	S		4/2007	Martin		
D542,560	S		5/2007	Ricci		
D545,070	S		6/2007	Hutton		
D549,470	S		8/2007	Hutton		
D552,864	S	*	10/2007	Natuzzi	.....	D6/381
D552,867	S	*	10/2007	Natuzzi	.....	D6/381
D569,111	S		5/2008	Swanson		
D569,112	S		5/2008	Swanson		
D569,113	S		5/2008	Lewis		
D571,574	S	*	6/2008	Natuzzi	.....	D6/381
D572,916	S		7/2008	Galardo et al.		
D573,358	S		7/2008	Gharabegian		
D577,211	S		9/2008	Natuzzi		
D577,222	S		9/2008	Natuzzi		
D577,506	S		9/2008	Natuzzi		
D580,670	S		11/2008	Weiss		
D583,585	S	*	12/2008	Weiss	.....	D6/381
D586,131	S		2/2009	Cramer et al.		
D586,156	S		2/2009	Schweikarth et al.		
D590,171	S		4/2009	Natuzzi		
D590,623	S		4/2009	Natuzzi		
D591,970	S		5/2009	Weiss		
D592,416	S		5/2009	Weiss		
D600,037	S		9/2009	Natuzzi		
D601,825	S		10/2009	Starck		
D603,617	S	*	11/2009	Weiss	.....	D6/381
D603,618	S		11/2009	Weiss		
D603,619	S		11/2009	Weiss		

D604,957	S		12/2009	Weiss		
D607,227	S		1/2010	Massaud		
D613,960	S	*	4/2010	Griepentrog et al.	.....	D6/381
D614,419	S		4/2010	Andersen		
D614,884	S		5/2010	Metcalf et al.		
D615,315	S		5/2010	Andersen		
D615,766	S		5/2010	Andersen		
D615,767	S	*	5/2010	Griepentrog et al.	.....	D6/381
D618,007	S		6/2010	Andersen		
D623,869	S		9/2010	Andersen		
D628,403	S		12/2010	Starck		
D630,029	S		1/2011	Delbridge		
D650,605	S	*	12/2011	Haimoff et al.	.....	D6/369
2002/0000741	A1	*	1/2002	Clay et al.	.....	297/118

OTHER PUBLICATIONS

Metropolitan Furniture Corporation. "Contract B". Interiors catalog. Copyright Apr. 1961.

Metropolitan Furniture Corporation. "Contract C". Interior Design catalog. Copyright Aug. 1962.

Metropolitan Furniture Corporation. "506J Vision". Palto alto Times, Copyright Nov. 19, 1957.

NLBAA Sofa, First Proof Journal Oregon Journal of CA 2-5511, Sunday, Oct. 11. No. 6226 Journal.

NLBAA Sofa, Sunset Magazine, Mar. 1961.

Metropolitan Furniture Company. "Sofa". Retailing Daily, Aug. 19, 1954, p. 10.

Metropolitan Furniture Company. "Chairs". Pennisula Living, Sep. 14-15, 1957, p. 25.

Metropolitan Furniture Company. "Sofa". Nat'l Furniture Review Aug. 15, 1961.

Metropolitan Furniture Company. Pierce Sofa, Nat'l Furniture Review, Aug. 15, 1961.

Metropolitan Furniture Company. Elegance/NLBAA Contract B Series, Contract Magazine, Feb. 1961.

Metropolitan Furniture Company. "Contract H". Metropolitan Furniture Sales Brochure 1961.

Metropolitan Furniture Company. "Contract B sofa, table and chair" National Furniture Review, Apr. 20, 1962.

Metropolitan Furniture Company. "Myriad collection", Printed publication published on or around Jun. 1961.

Metropolitan Furniture Company. "Contract B Table". Metropolitan Brochure.

Advertisement from Sloane's (San Francisco). San Francisciana.

Metropolitan Furniture Company. Advertisement/Brochure.

Metropolitan Furniture Company. "Elegance at a Price". In-house Metropolitan ad/brochure.

Metropolitan Furniture Company. "Sofa". Advertisement.

Sloane's (San Francisco) Sofas and Chairs. Advertisement.

Metropolitan Furniture Company. "Metropolitan's high-back chair". Metropolitan Furniture Company. "Sofa". Fraser's /Berkeley Telegraph and Channing advertisement.

Metropolitan Furniture Company. "The Weekender Sofa/Bed". Furniture Forum catalog, section 1, p. 32.

\* cited by examiner

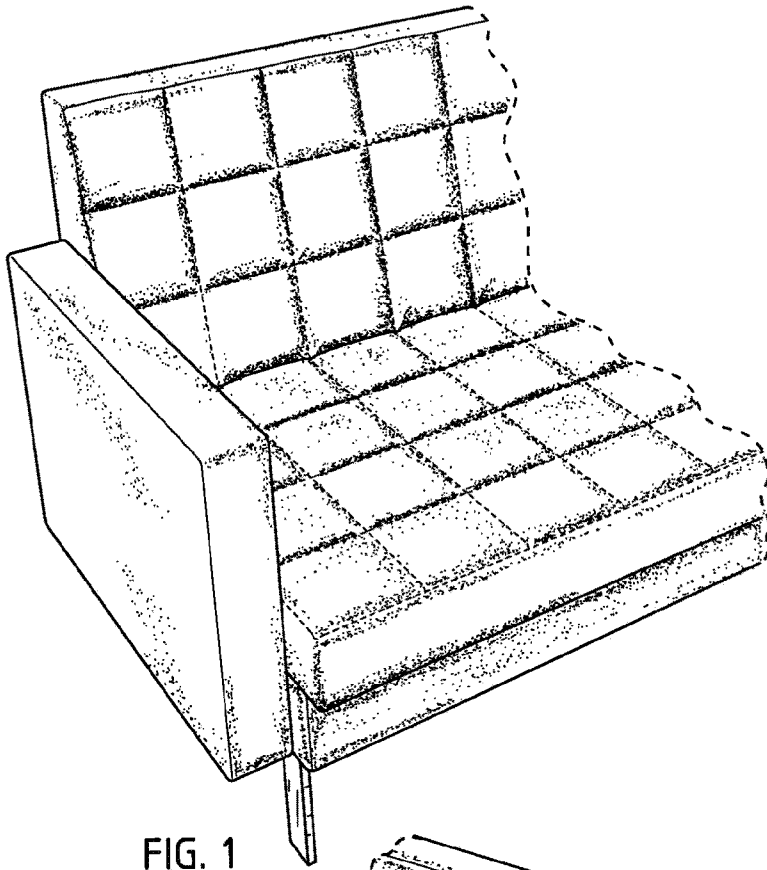

FIG. 1

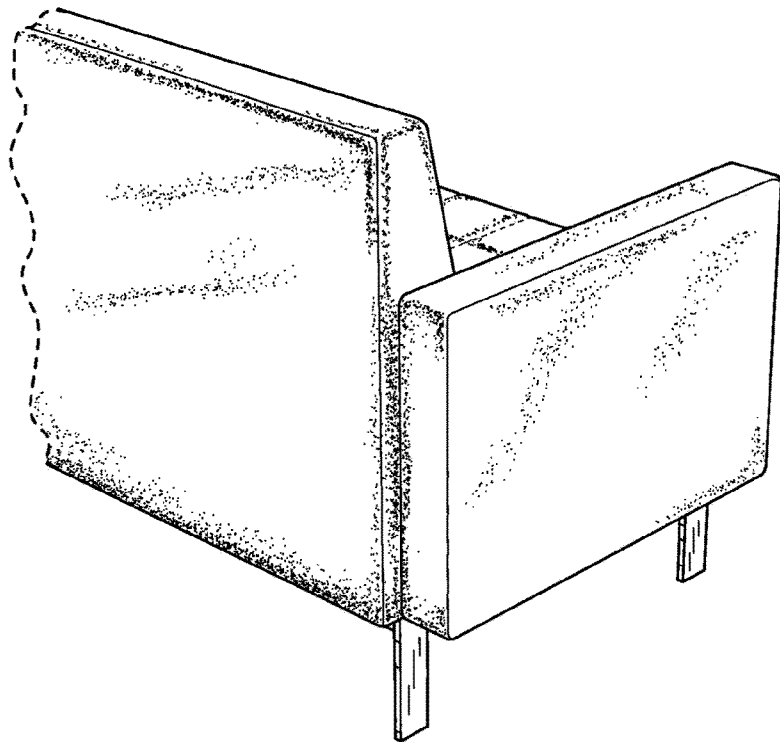

FIG. 2

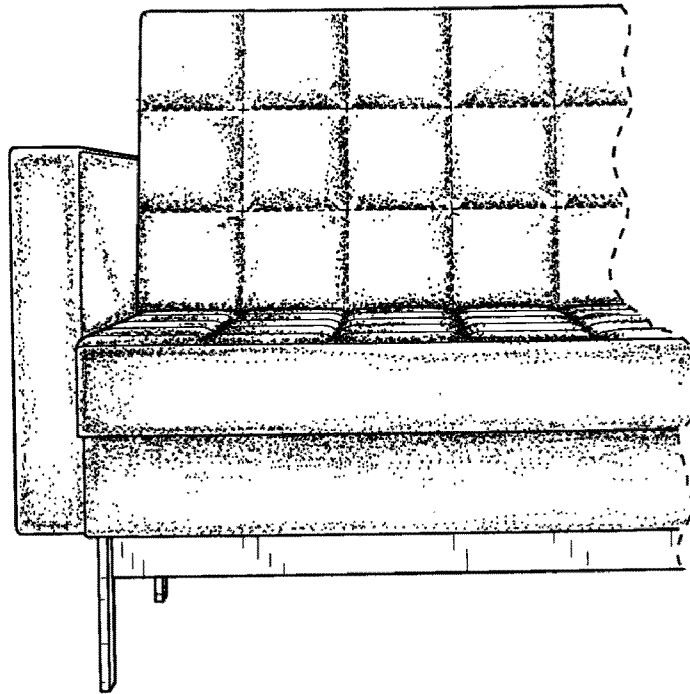

FIG. 3

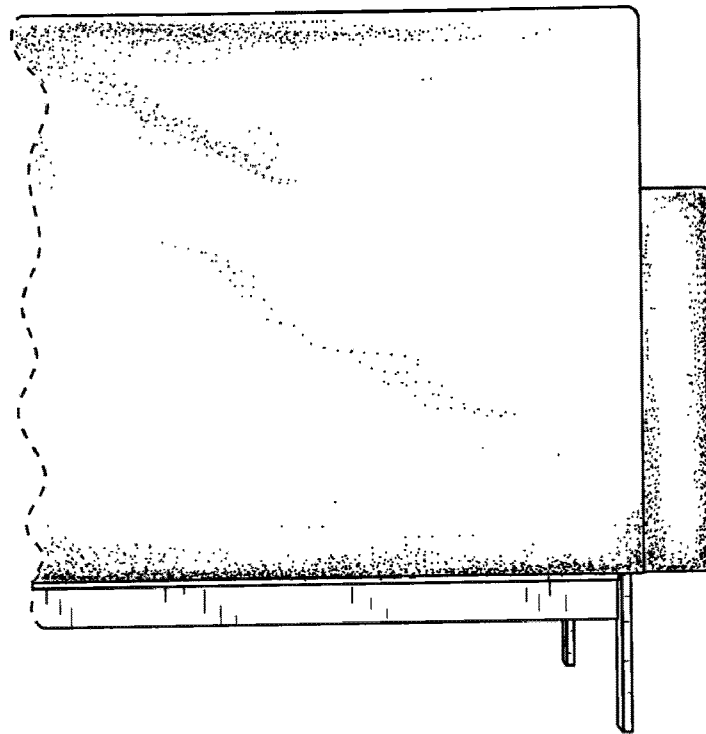

FIG. 4

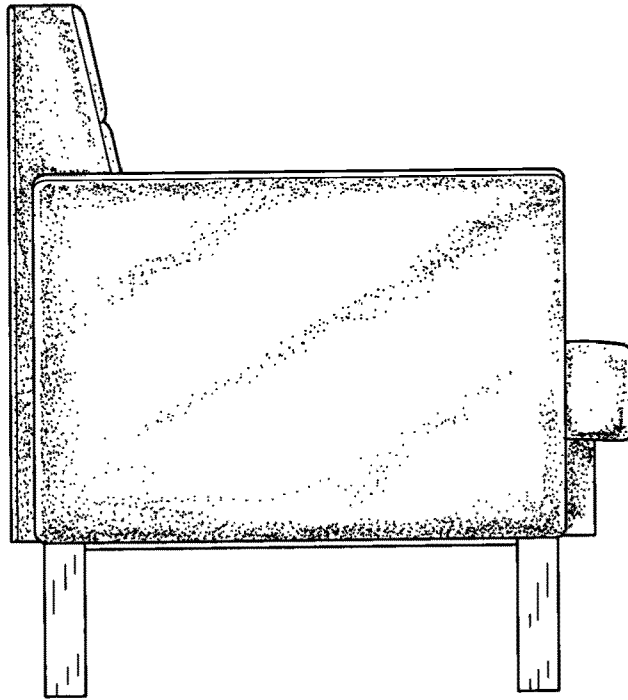

FIG. 5

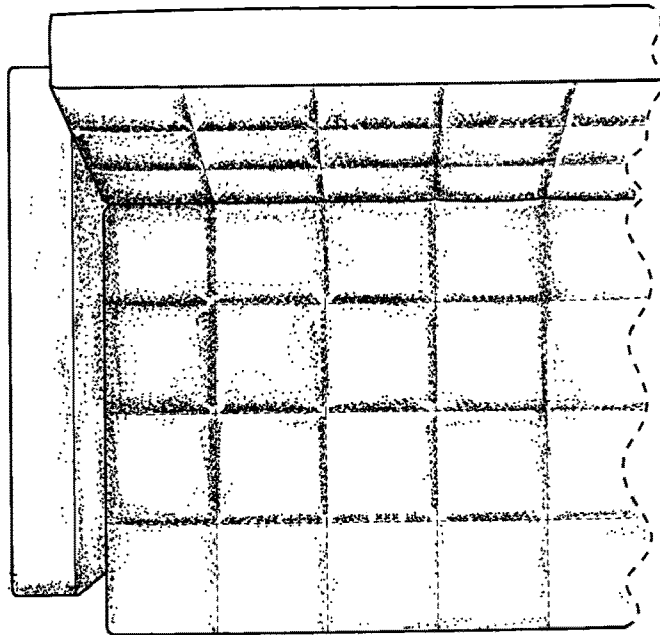

FIG. 6