



US00D989084S

(12) **United States Design Patent**  
**Mercaldi**

(10) **Patent No.:** **US D989,084 S**

(45) **Date of Patent:** **\*\* \*Jun. 13, 2023**

(54) **MONITOR ADAPTER**

(71) Applicant: **Joseph Mercaldi**, Montreal (CA)

(72) Inventor: **Joseph Mercaldi**, Montreal (CA)

(73) Assignee: **GLADIATOR JOE INC.**, Montreal (CA)

(\* ) Notice: This patent is subject to a terminal disclaimer.

(\*\*) Term: **15 Years**

(21) Appl. No.: **29/774,279**

(22) Filed: **Mar. 16, 2021**

(51) **LOC (14) Cl.** ..... **14-01**

(52) **U.S. Cl.**  
USPC ..... **D14/229**

(58) **Field of Classification Search**

USPC ..... D14/371-382, 125-129, 335-337, D14/447-452, 492, 376-382, 239, 229, D14/457, 439-441, 432, 251-253; D8/349, 354, 363, 373, 376, 380; 348/180, 184, 325, 739, 825; D12/407, D12/415; D3/218; 341/12; D13/108  
CPC ..... G06F 3/0412; G06F 3/016; G06F 3/0488; G06F 3/011; G06F 3/038; G06F 3/03543; G06F 3/0338; G06F 3/0202; G06F 3/0219; G06F 3/0213; G06F 1/1616; G06F 3/023; G06F 3/04883; G02F 1/13338; G02F 1/1313; G02F 1/1333; G02F 1/135; G02F 1/132; G02F 1/133308; G02F 1/134309; G02F 1/13718; G09G 3/3648; G06K 15/1252; B41J 2/465; G03F 7/70291; G02B 27/0172; G02B 5/30; G02B 2027/0118; G02B 27/0101; F16M 13/02; F16M 13/00; F16M 11/10; F16M 11/04; F16M 2200/08; F16M 11/2021; A47B 21/0314; A47B 88/044; A47B 2021/0335; H02G 3/126; F16B 47/00; F16B 47/006; A47G 1/17; A47K 2201/00

See application file for complete search history.

(56) **References Cited**

U.S. PATENT DOCUMENTS

2,896,901 A \* 7/1959 Levy ..... F21V 21/30  
248/278.1  
D418,044 S 12/1999 Schoeneweis  
6,079,682 A \* 6/2000 Olkkola ..... B60R 11/0241  
248/292.12  
D505,671 S \* 5/2005 Dayan ..... D14/216  
D568,144 S \* 5/2008 Wohlford ..... D8/354  
D568,721 S 5/2008 Greaves  
D624,055 S \* 9/2010 Lazzeroni ..... D14/221  
D637,593 S \* 5/2011 Zanetti ..... D14/253  
D652,836 S \* 1/2012 Voorhees ..... D14/238.1

(Continued)

OTHER PUBLICATIONS

US Trademark Registration No. 4825669; Word Mark—Gladiator Joe Registration date: Oct. 6, 2015 Publication date: Jul. 21, 2015.

(Continued)

*Primary Examiner* — Katie Jane Stofko

(74) *Attorney, Agent, or Firm* — Legalforce RAPC  
Worldwide

(57) **CLAIM**

The ornamental design for a monitor adapter, as shown and described.

**DESCRIPTION**

FIG. 1 is a rear, bottom and left side perspective view of a monitor adapter, showing my new design;  
FIG. 2 is a front elevational view thereof;  
FIG. 3 is a rear elevational view thereof;  
FIG. 4 is a right side elevational view thereof;  
FIG. 5 is a left side elevational view thereof;  
FIG. 6 is a top plan view thereof; and,  
FIG. 7 is a bottom plan view thereof.

**1 Claim, 7 Drawing Sheets**

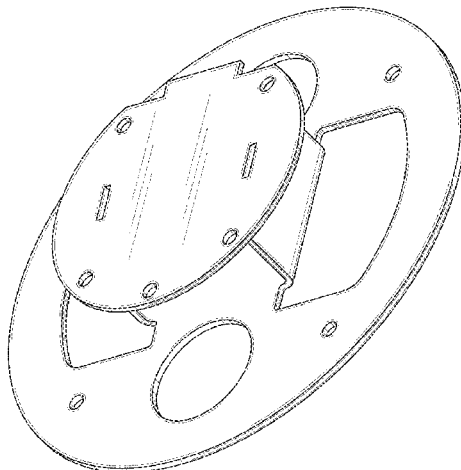

(56)

**References Cited**

U.S. PATENT DOCUMENTS

D734,129	S	7/2015	Allen et al.	
D819,427	S	6/2018	Mercaldi	
D822,453	S	7/2018	Kanter	
D822,454	S	7/2018	Kanter	
D823,093	S	7/2018	Kanter	
D823,094	S	7/2018	Kanter	
D826,906	S *	8/2018	Lasnier de Lavalette	..... D8/349
D833,851	S	11/2018	Kanter	
D891,232	S	7/2020	Zhang	
D899,225	S	10/2020	Zhang	
D900,593	S	11/2020	McKillips	
D901,483	S *	11/2020	Kory	..... D8/382
D901,745	S *	11/2020	Yang	..... D26/74
D921,474	S *	6/2021	Borst	..... D8/349
D922,177	S *	6/2021	Pride	..... D8/349
D942,665	S *	2/2022	Hsu	..... D26/74

OTHER PUBLICATIONS

US Trademark Registration No. 4825790; Word Mark—G J Registration date: Oct. 6, 2015 Publication date: Jul. 21, 2015.

US Trademark Registration No. 5298001; Word Mark—I Am Gladiator I Am Victorious Registration date: Sep. 26, 2017 Publication date: Jan. 24, 2017.

“Apple Vesa Mount Adapter” by Apple Computer, Published Online on [Dec. 12, 2019] [https://images-na.ssl-images-amazon.com/images/I/61c3eHVjvHL.\\_AC\\_SL1389\\_.jpg](https://images-na.ssl-images-amazon.com/images/I/61c3eHVjvHL._AC_SL1389_.jpg).

“AmazonBasics Tilting TV Wall Mount” by AmazonBasics, Published Online on [Sep. 16, 2017] [https://images-na.ssl-images-amazon.com/images/I/91%2BJyS1JxKL.\\_SL1500\\_.jpg](https://images-na.ssl-images-amazon.com/images/I/91%2BJyS1JxKL._SL1500_.jpg).

“Universal Articulating TV Wall Mount” by Sound Around, Published Online on [Oct. 8, 2010] [https://images-na.ssl-images-amazon.com/images/I/619TvuATIiL.\\_AC\\_SL1000\\_.jpg](https://images-na.ssl-images-amazon.com/images/I/619TvuATIiL._AC_SL1000_.jpg).

“InstallerParts 10"-23" TV Wall Mount Bracket” by InstallerParts, Published Online on [Jul. 7, 2012] [https://images-na.ssl-images-amazon.com/images/I/31gKKRgjLmL.\\_AC\\_.jpg](https://images-na.ssl-images-amazon.com/images/I/31gKKRgjLmL._AC_.jpg).

“B-Tech AviBall Swivel Tilt Wall Mount Bracket” by B-Tech AviBall, Found Online on [Mar. 22, 2021] <https://www.selby.com.au/media/catalog/product/cache/8dc42fa2ff86d291f127c1bcf7f58b48/b/t/bt7519c-chrome-bracket-1.jpg>.

\* cited by examiner

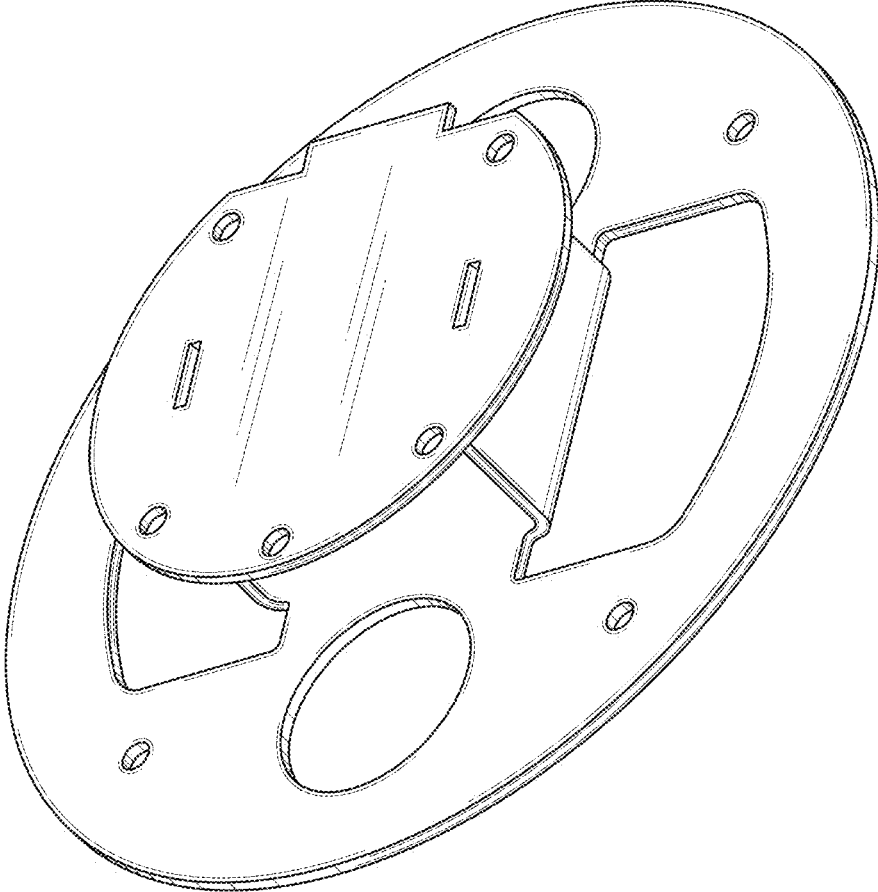

FIG. 1

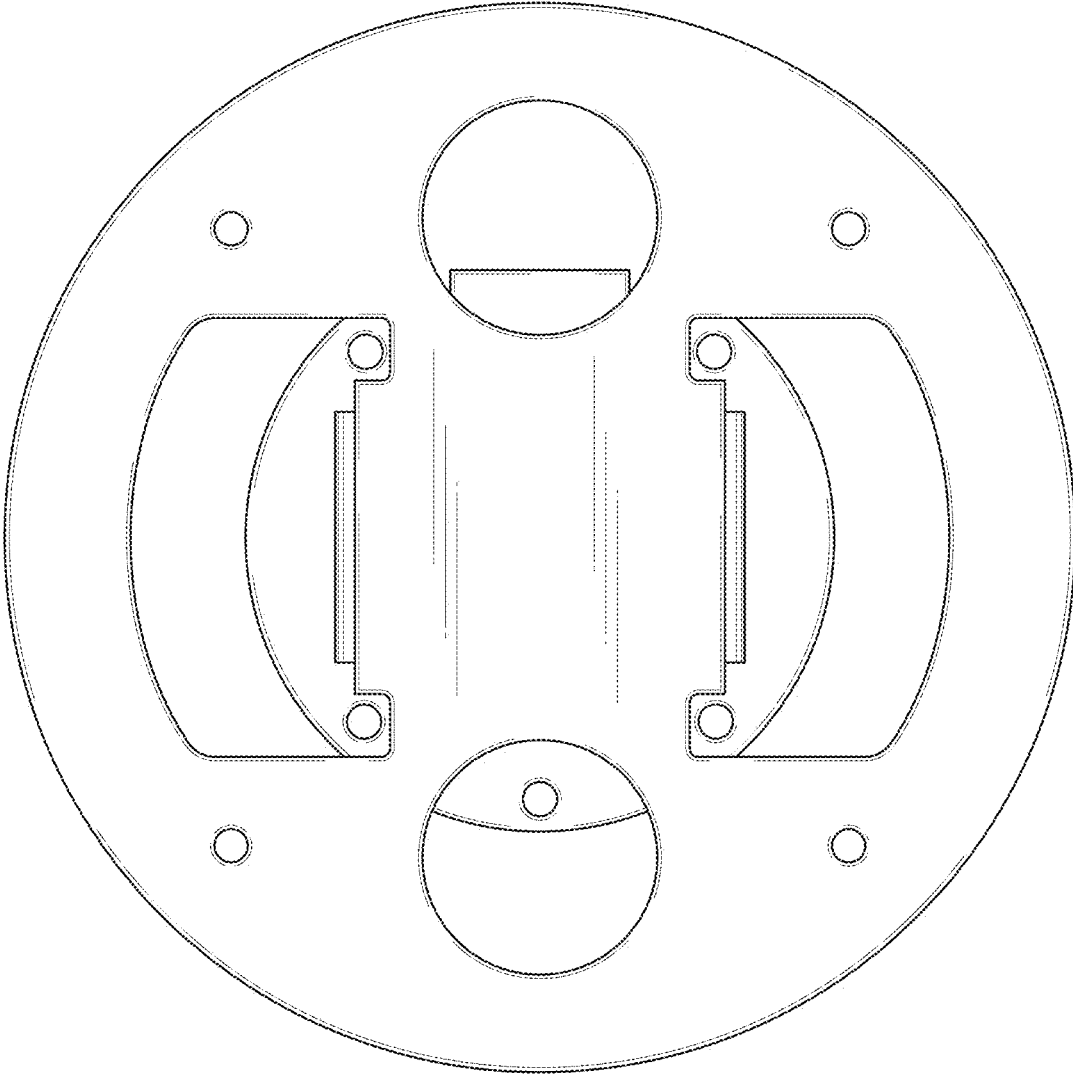

FIG. 2

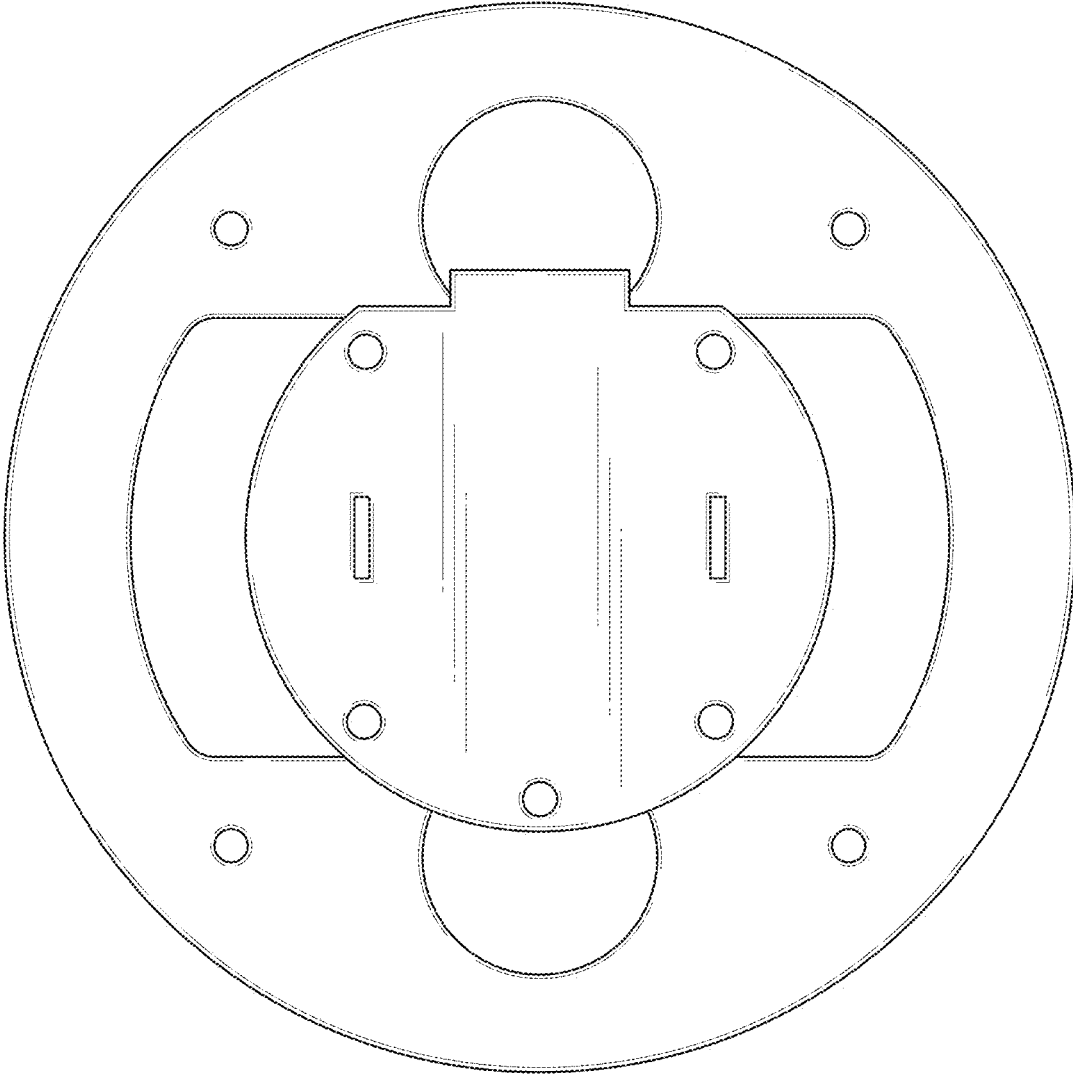

FIG. 3

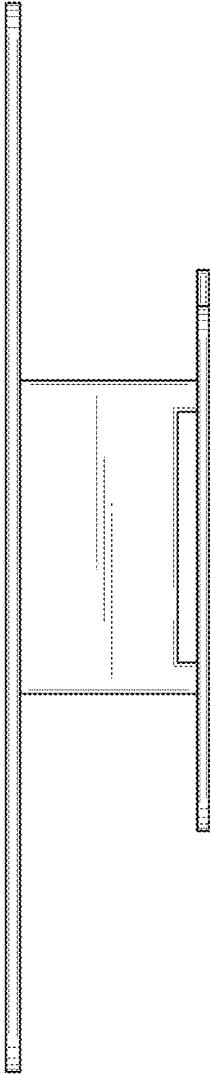

FIG. 4

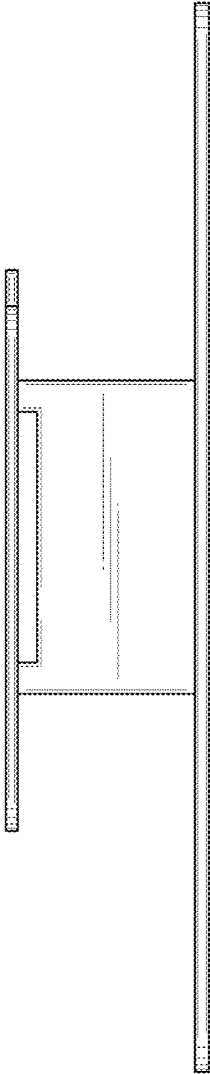

FIG. 5

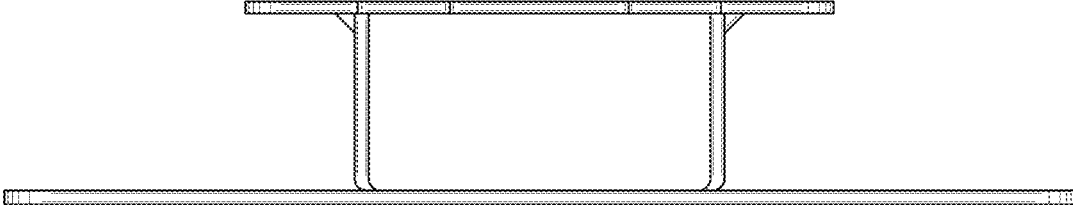

FIG. 6





FIG. 7