



US00D629374S

(12) **United States Design Patent**
Fujii et al.

(10) **Patent No.:** **US D629,374 S**

(45) **Date of Patent:** **** Dec. 21, 2010**

(54) **VIDEO DISPLAY APPARATUS**

(75) Inventors: **Hiroya Fujii**, Los Angeles, CA (US);
Isamu Arie, Santa Monica, CA (US);
Justin Randolph Jakobson, Venice, CA
(US); **Yuji Oikawa**, Marina Del Ray, CA
(US)

(73) Assignee: **Sony Corporation**, Tokyo (JP)

(**) Term: **14 Years**

(21) Appl. No.: **29/356,216**

(22) Filed: **Feb. 22, 2010**

(51) **LOC (9) Cl.** **14-03**

(52) **U.S. Cl.** **D14/129; D14/126**

(58) **Field of Classification Search** D14/125-134,
D14/239, 371, 136, 374-377, 440, 450, 448,
D14/336, 342; 312/7.2; 348/836, 838, 180,
348/184, 325, 739; 341/12; 248/917-924,
248/465; 345/104, 133, 156, 168, 87, 173;
720/605, 669, 600, 655; 369/99, 197; 455/344,
455/347; D21/329, 515, 577, 622, 333, 433,
D21/448, 452, 450, 331; D6/477, 479, 300;
273/148 B; 446/484, 175, 356; D10/15,
D10/26

See application file for complete search history.

(56) **References Cited**

U.S. PATENT DOCUMENTS

D454,846	S	*	3/2002	Goto	D14/129
D534,137	S	*	12/2006	Izumi	D14/126
D534,139	S	*	12/2006	Yokota	D14/126
D534,511	S	*	1/2007	Maeda et al.	D14/129
D543,163	S	*	5/2007	Yang et al.	D14/126
D550,635	S	*	9/2007	DeMaio et al.	D14/126
D555,610	S	*	11/2007	Yang et al.	D14/126
D566,072	S	*	4/2008	Yamaguchi	D14/126
D588,560	S	*	3/2009	Mellingen et al.	D14/126

OTHER PUBLICATIONS

"Artison SB-1 SoudnBar", http://signature.crutchfiled.com/S-sR-rONjUfjgj/s_733SB1/Artison-SB-1-Sound-Bar.html.

JVC, "JVC Announces 4.1-Channel Sound Bar Home Theater Systems" <http://www.jvc.com/press/index.jsp?item=718&pageID=1>, Sep. 10, 2009.

Philips, "Made specially for you 32" SoundBar and flat TV", http://www.consumer.philips.com/c/home-cinemasystems/sts8003_00/prd/gb/.

* cited by examiner

Primary Examiner—Raphael Barkai

(74) *Attorney, Agent, or Firm*—John L. Rogitz

(57) **CLAIM**

The ornamental design for the video display apparatus, as shown and described.

DESCRIPTION

FIG. 1 is a front perspective view of the video display apparatus;

FIG. 2 is a rear perspective view of the video display apparatus;

FIG. 3 is a front elevational view of the video display apparatus shown in FIG. 1;

FIG. 4 is a rear elevational view of the video display apparatus shown in FIG. 1;

FIG. 5 is a right side elevational view of the video display apparatus;

FIG. 6 is a left side elevational view of the video display apparatus;

FIG. 7 is a top plan view of the video display apparatus shown in FIG. 1;

FIG. 8 is a front perspective view of detachable speaker that may be attached to the video display apparatus shown in FIG. 1;

FIG. 9 is a rear elevational view of the speaker shown in FIG. 8;

FIG. 10 is a front elevational view of the speaker shown in FIG. 8;

FIG. 11 is a right side elevational view of the speaker shown in FIG. 8;

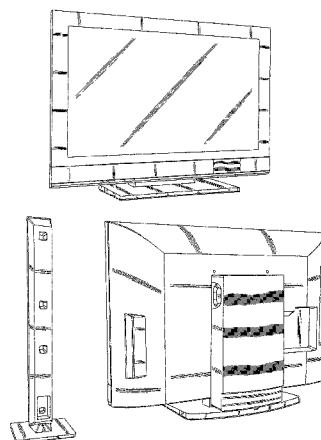

FIG. 12 is a left side elevational view of the speaker shown in FIG. 8;

FIG. 13 is a top plan view of the speaker shown in FIG. 8;

FIG. 14 is a bottom plan view of the speaker shown in FIG. 8;

FIG. 15 is a front perspective view of a speaker that can be electrically connected to the video display apparatus shown in FIG. 1;

FIG. 16 is a rear perspective view of the speaker shown in FIG. 15;

FIG. 17 is a front elevational view of the speaker shown in FIG. 15;

FIG. 18 is a rear elevational view of the speaker shown in FIG. 15;

FIG. 19 is a side elevational view of the speaker shown in FIG. 15;

FIG. 20 is a top plan view of the speaker shown in FIG. 15; and,

FIG. 21 is a rear perspective view showing the speaker depicted in FIG. 8 attached to the video display apparatus shown in FIG. 1 and the speaker depicted in FIG. 15 juxtaposed with the video display apparatus shown in FIG. 1.

Elements of the design are shown separately for ease of illustration only.

1 Claim, 11 Drawing Sheets

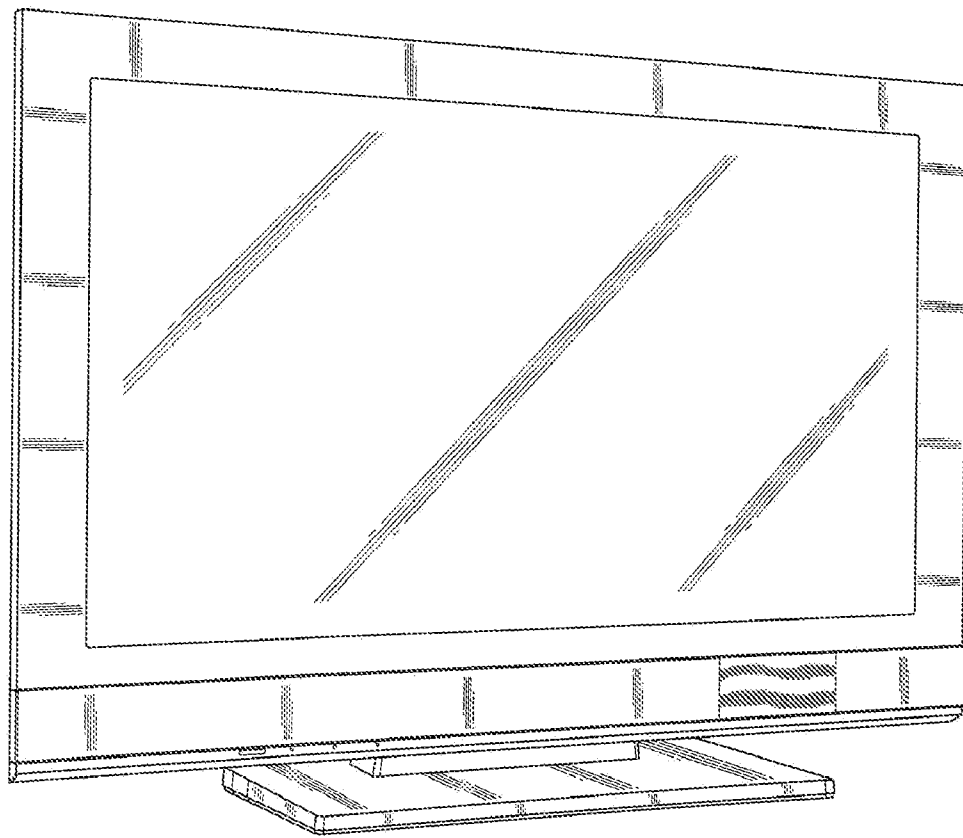

FIG. 1

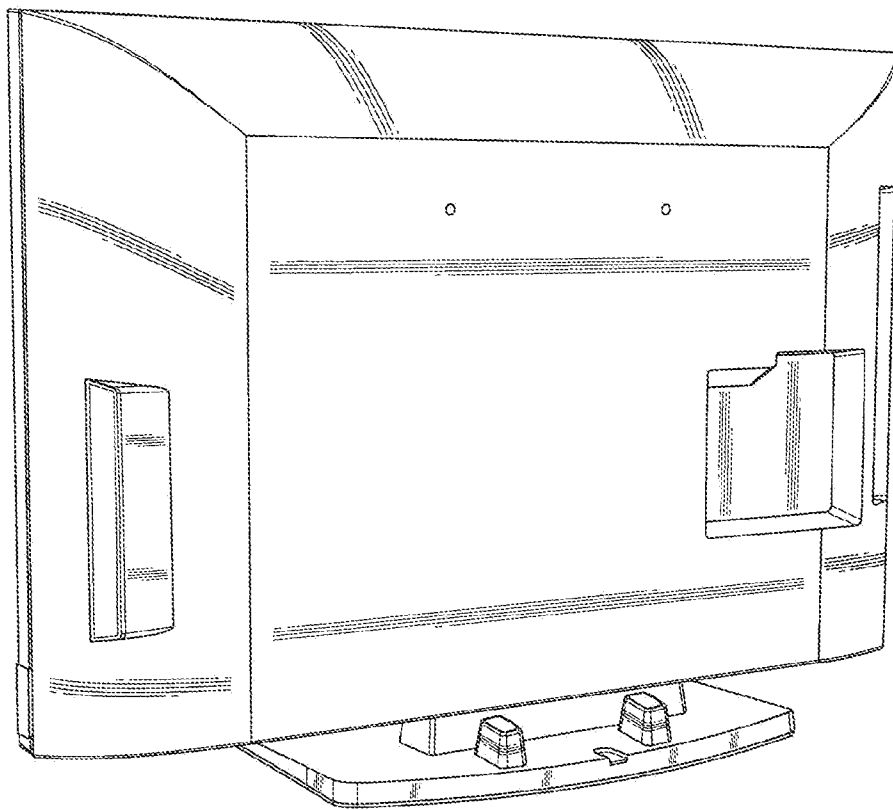

FIG. 2

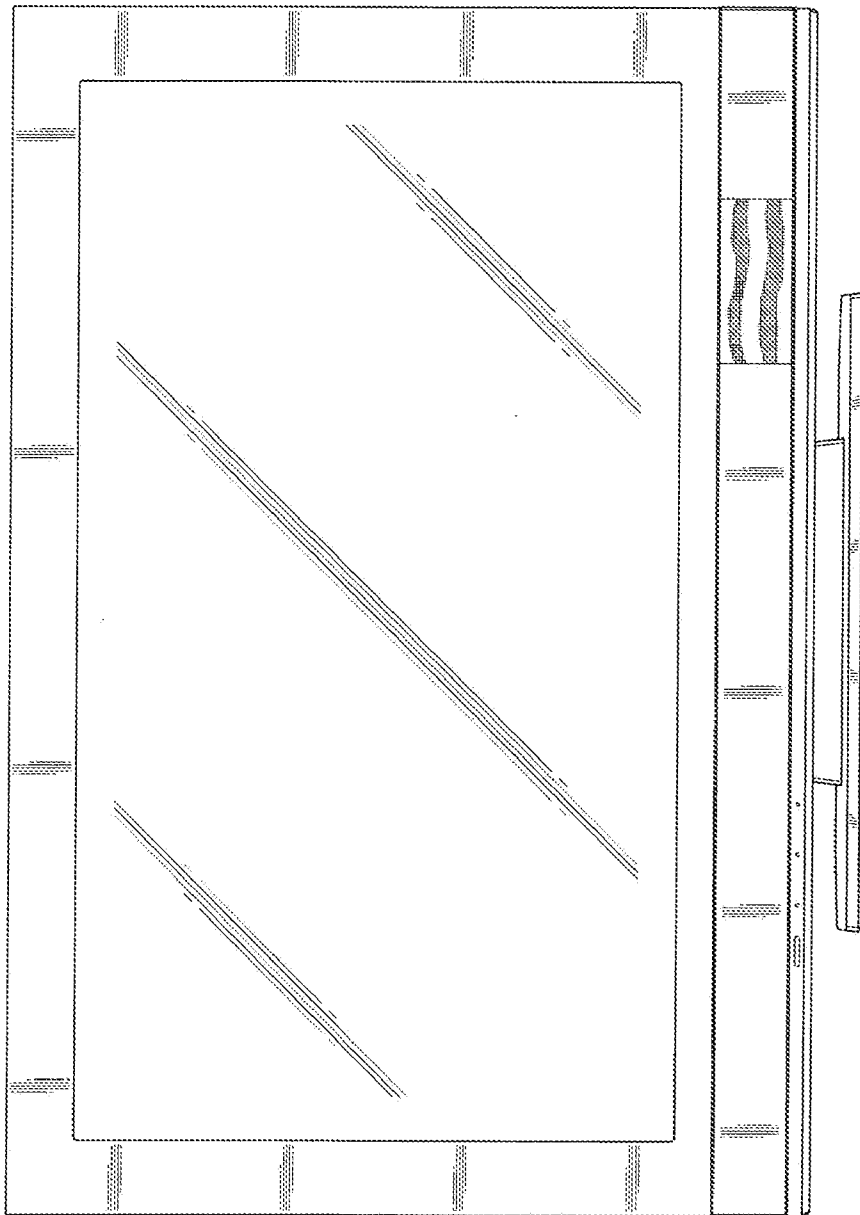

FIG. 3

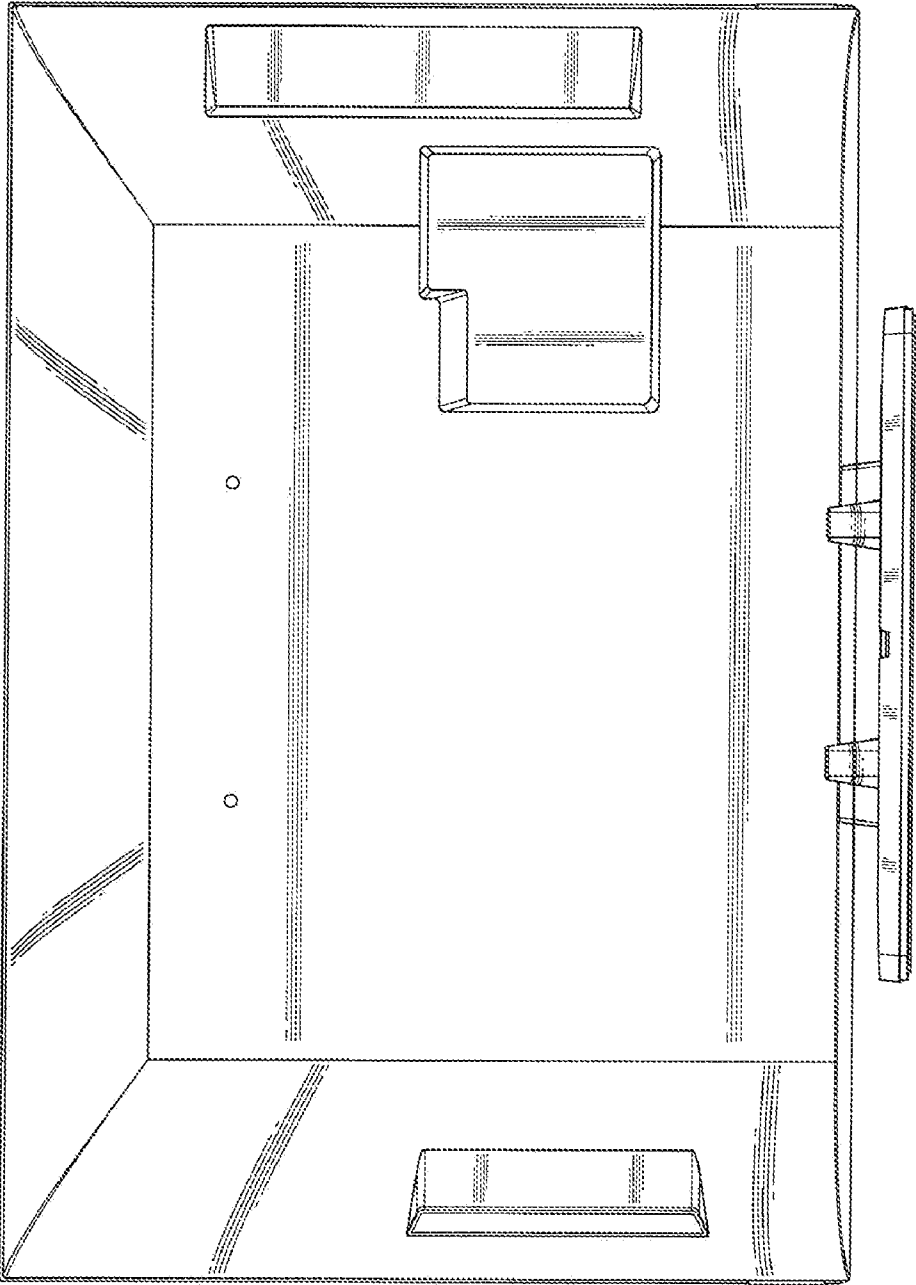

FIG. 4

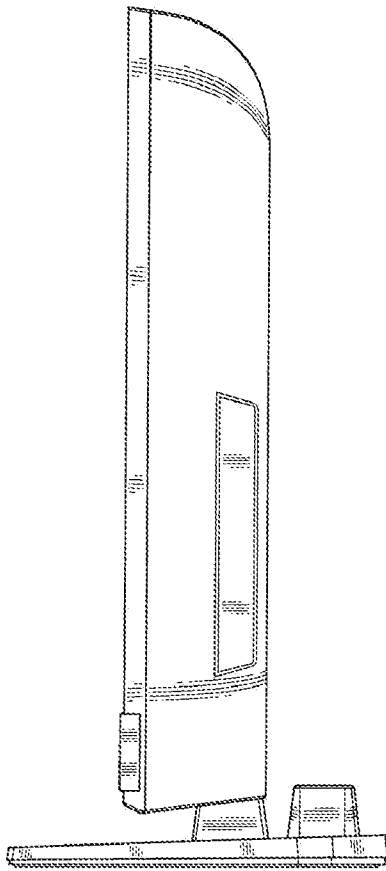

FIG. 5

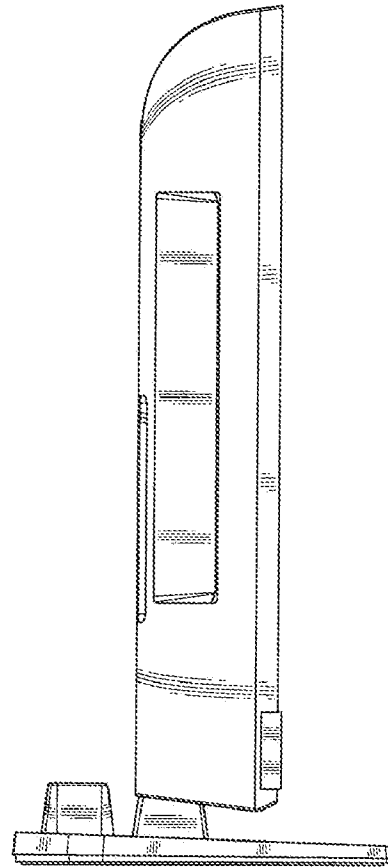

FIG. 6

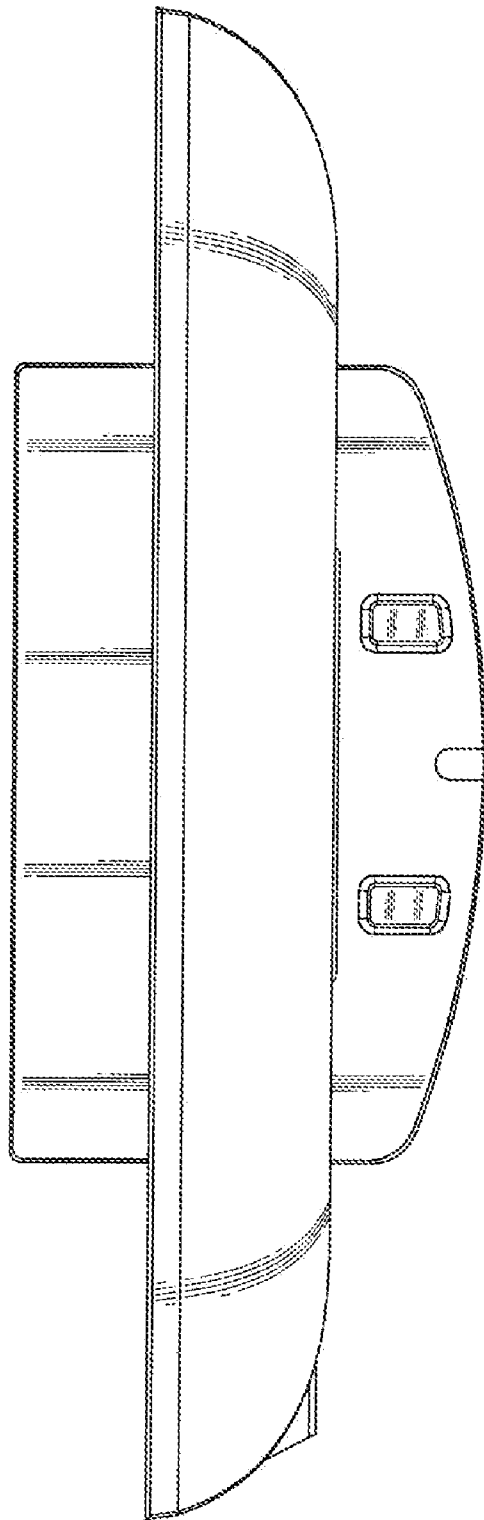

FIG. 7

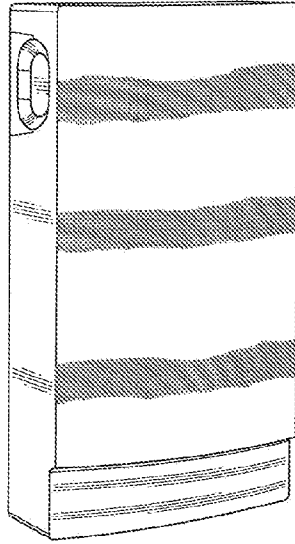

FIG. 8

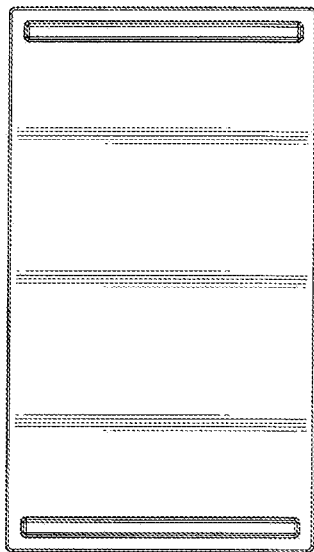

FIG. 9

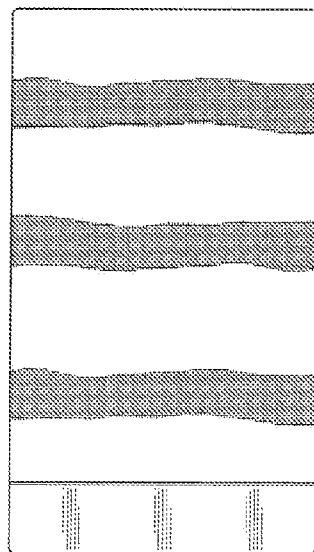

FIG. 10

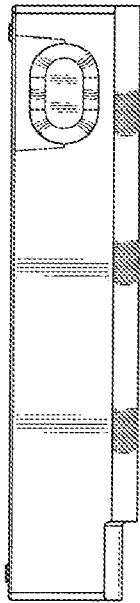

FIG. 11

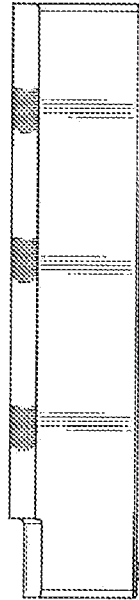

FIG. 12

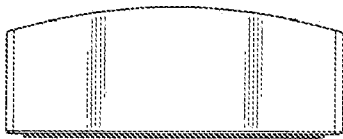

FIG. 13

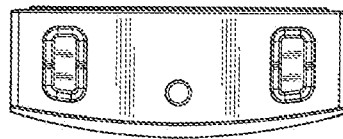

FIG. 14

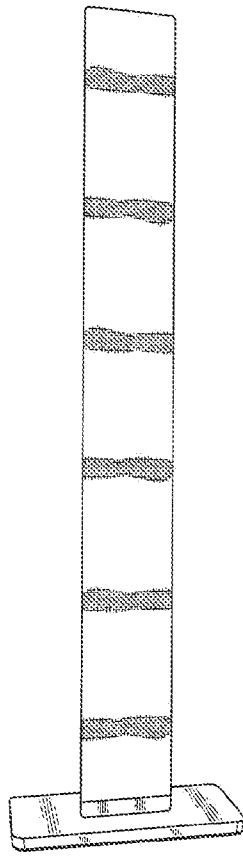

FIG. 15

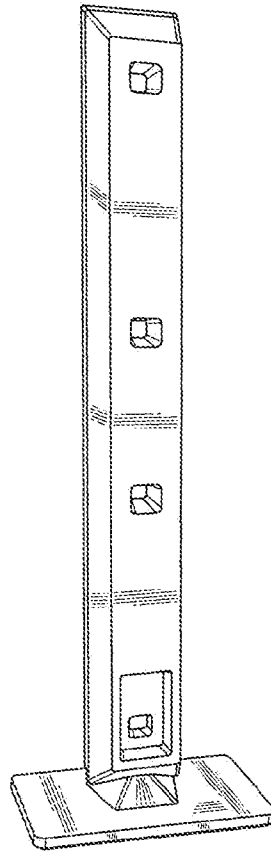

FIG. 16

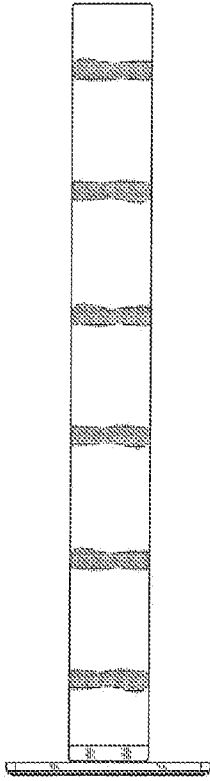

FIG. 17

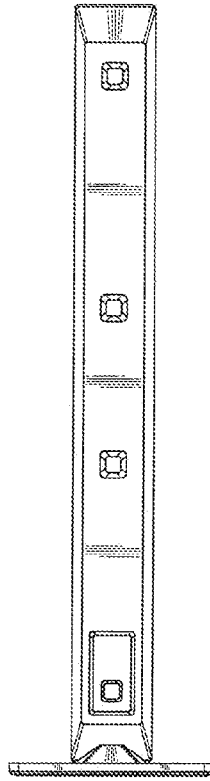

FIG. 18

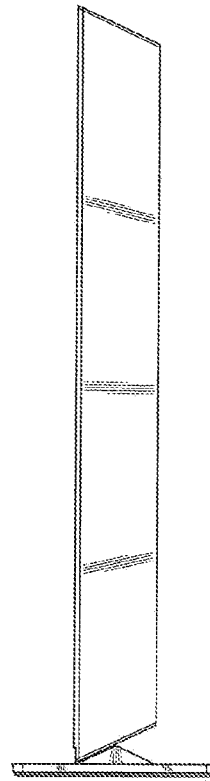

FIG. 19

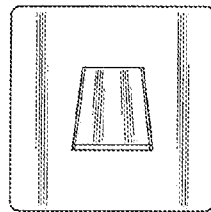

FIG. 20

