



US00D925514S

(12) **United States Design Patent**  
**Chung**

(10) **Patent No.:** **US D925,514 S**

(45) **Date of Patent:** **\*\* Jul. 20, 2021**

- (54) **MOBILE PHONE CASE**
- (71) Applicant: **ISPEAKER CO., LTD.**, Goyang-Si (KR)
- (72) Inventor: **Young Suk Chung**, Goyang-Si (KR)
- (73) Assignee: **ISPEAKER CO., LTD.**
- (\*\*) Term: **15 Years**

9,721,077	B1 *	8/2017	Daniel	.....	G06F 21/86
D824,892	S *	8/2018	Altschul	.....	D14/250
D830,352	S *	10/2018	Chung	.....	D14/250
D832,244	S *	10/2018	Poon	.....	D14/250
D834,010	S *	11/2018	Kim	.....	D14/250
D836,096	S *	12/2018	Altschul	.....	D14/250
D837,775	S *	1/2019	Koo	.....	D14/250
D837,776	S *	1/2019	Chung	.....	D14/250
D849,733	S *	5/2019	Yun	.....	D14/250

(Continued)

- (21) Appl. No.: **29/713,297**
- (22) Filed: **Nov. 14, 2019**

**OTHER PUBLICATIONS**

“COOYA Compatible with iPhone 12 Case/iPhone 12 Pro Case Wallet [ . . . ]” [online]. COOYA. [Date first available Oct. 13, 2020]. Retrieved from the Internet: <<https://www.amazon.com/dp/B08JM2BLS1>>.\*

(Continued)

(30) **Foreign Application Priority Data**

Oct. 18, 2019 (KR) ..... 30-2019-0049627

(51) **LOC (13) Cl.** ..... **14-03**

(52) **U.S. Cl.**  
USPC ..... **D14/250**

(58) **Field of Classification Search**

USPC .... D14/217, 238.1, 240, 248, 250, 251–253,  
D14/439, 440, 447; D13/107–108, 103,  
D13/119; D3/201, 218, 247, 269, 273,  
D3/301, 303

CPC ..... H04B 1/3888; H04M 1/0283;  
H04M 1/0202; A45C 1/06; A45C 11/00;  
A45C 13/02; A45C 2011/002; A45F  
2005/026; A45F 2200/0525; A45F  
2200/0516

See application file for complete search history.

*Primary Examiner* — Mojtaba Tehrani  
(74) *Attorney, Agent, or Firm* — Renaissance IP Law Group LLP

(57) **CLAIM**

The ornamental design for a mobile phone case, as shown and described.

**DESCRIPTION**

FIG. 1 is a perspective view showing our new design for a mobile phone case;  
FIG. 2 is a front view thereof;  
FIG. 3 is a rear view thereof;  
FIG. 4 is a left side view thereof;  
FIG. 5 is a right side view thereof;  
FIG. 6 is a top plan view thereof;  
FIG. 7 is a bottom plan view thereof; and,  
FIG. 8 is a perspective illustrating the mobile phone case of the present invention in its environment of use.  
The broken lines in the drawings depict unclaimed portions of the case only and form no part of the claim designed.

(56) **References Cited**

**U.S. PATENT DOCUMENTS**

D688,655	S *	8/2013	Rey-Hipolito	.....	D14/250
D703,651	S *	4/2014	Ehrlich	.....	D14/250
D744,470	S *	12/2015	Stevinson	.....	D14/250
D759,004	S *	6/2016	Stevinson	.....	D14/250
9,521,223	B1 *	12/2016	Rajagopalan	....	H04M 1/72569
D780,163	S *	2/2017	Fathollahi	.....	D14/250
9,661,116	B1 *	5/2017	Chung	.....	A45C 11/00

**1 Claim, 7 Drawing Sheets**

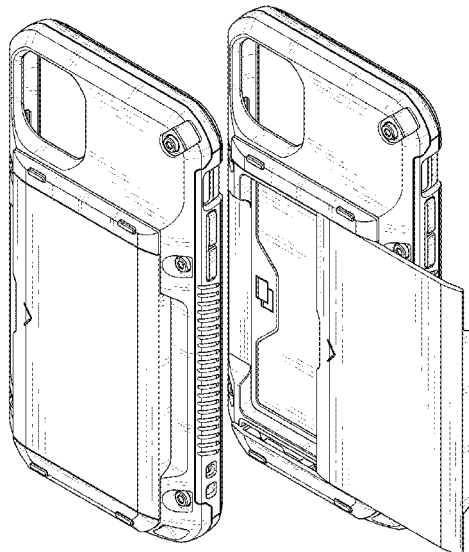

(56)

**References Cited**

## U.S. PATENT DOCUMENTS

D850,373	S	*	6/2019	Zhang	.....	D13/108
D850,435	S	*	6/2019	Yun	.....	D14/250
D855,607	S	*	8/2019	Altschul	.....	D14/250
D859,391	S	*	9/2019	Yun	.....	D14/250
D864,936	S	*	10/2019	Chiang	.....	D14/250
D865,742	S	*	11/2019	Altschul	.....	D14/250
D865,743	S	*	11/2019	Altschul	.....	D14/250
D868,051	S	*	11/2019	Kim	.....	D14/250
D879,757	S	*	3/2020	Altschul	.....	D14/250
D879,758	S	*	3/2020	Altschul	.....	D14/250
D880,465	S	*	4/2020	Altschul	.....	D14/250
D892,783	S	*	8/2020	Kim	.....	D14/250
2018/0191395	A1	*	7/2018	Chung	.....	A45C 11/182
2020/0310491	A1	*	10/2020	Kim	.....	H02J 7/0044

## OTHER PUBLICATIONS

“VRS Design Damda Glide Pro Compatible for iPhone 12/12 ProCase, [ . . . ]” [online]. VRS Design. [Date first available Sep. 23, 2020]. Retrieved from the Internet: <<https://www.amazon.com/dp/B08JWY9JWH>>.\*

\* cited by examiner

FIG. 1

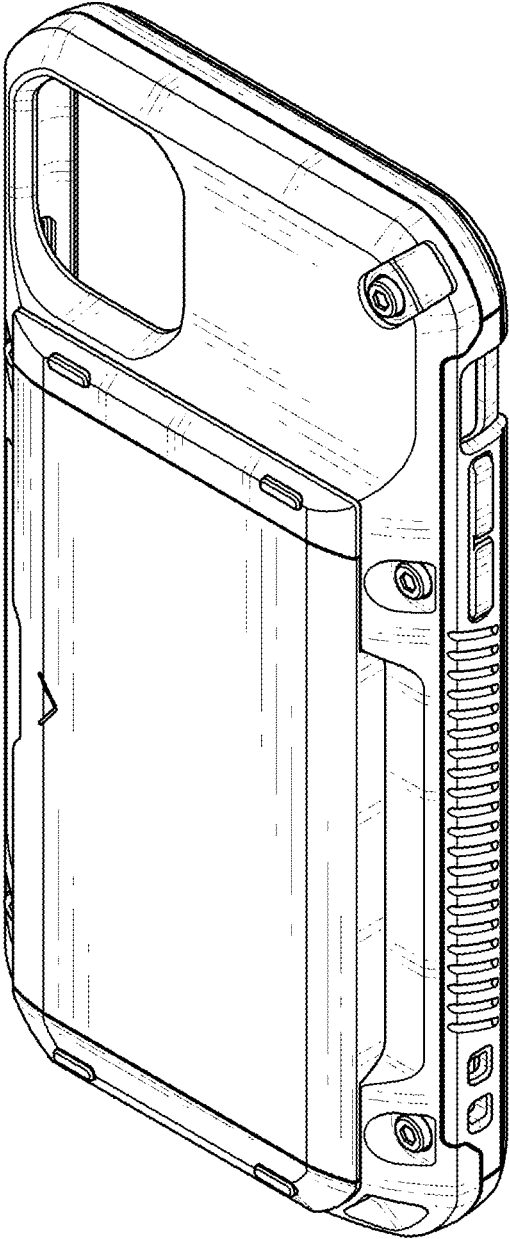

FIG. 2

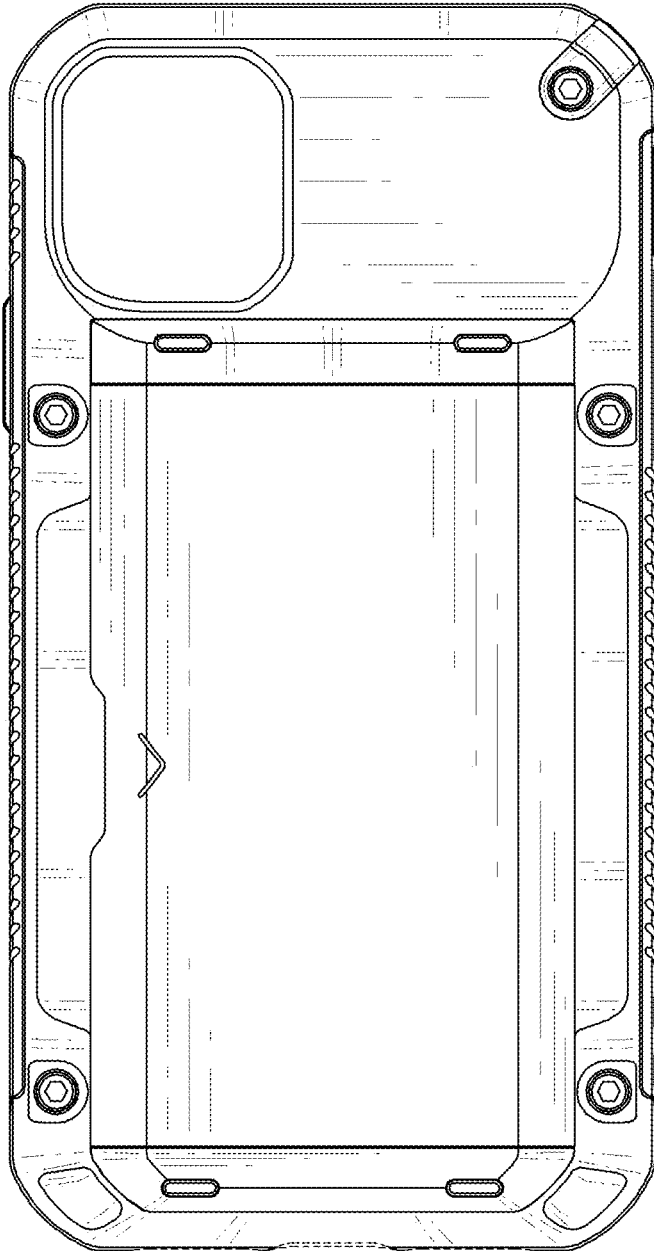

FIG. 3

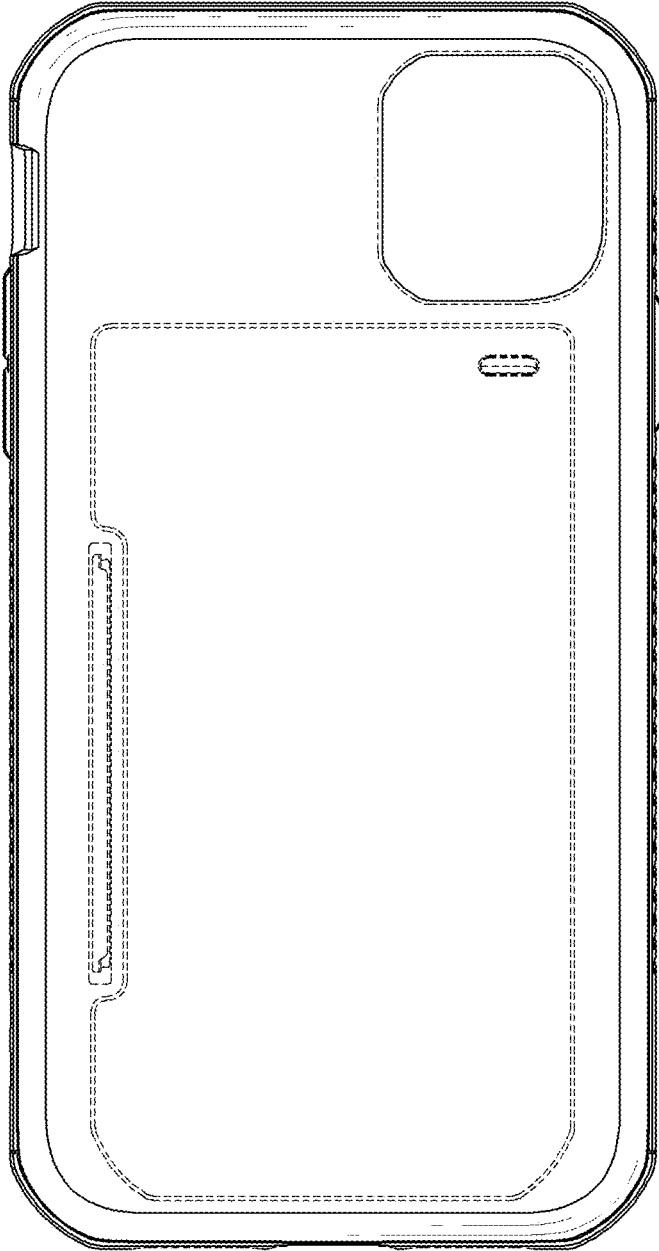

FIG. 4

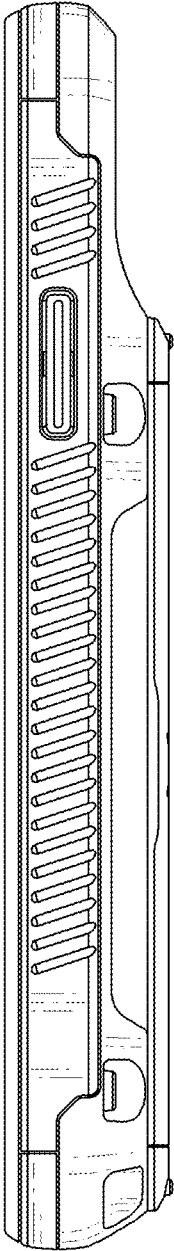

FIG. 5

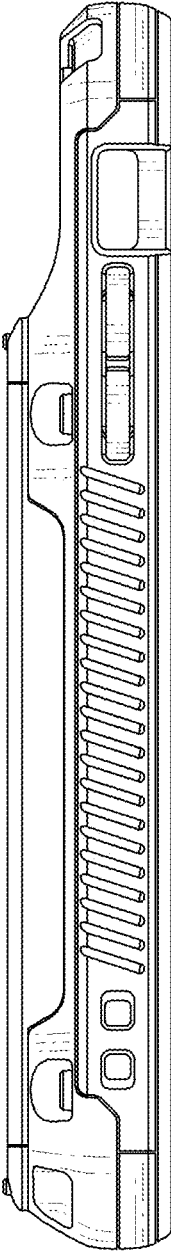

FIG. 6

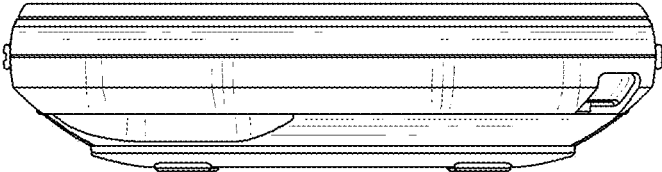

FIG. 7

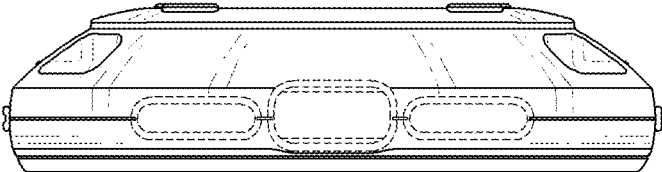



FIG. 8

