



US00D502394S

(12) **United States Design Patent**  
**Jackson et al.**

(10) **Patent No.:** **US D502,394 S**

(45) **Date of Patent:** **\*\* Mar. 1, 2005**

(54) **FOOD PACKAGE**

(75) Inventors: **Daniel C. Jackson**, Plymouth, MN (US); **Nicolas Bouveret**, St-Placide (CA); **Jean-Pierre Lacroix**, Bois d'Amont (FR)

(73) Assignee: **Land O'Lakes, Inc.**, Arden Hills, MN (US)

(\*\*) Term: **14 Years**

(21) Appl. No.: **29/208,126**

(22) Filed: **Jun. 24, 2004**

**Related U.S. Application Data**

(62) Division of application No. 29/193,960, filed on Nov. 17, 2003, now Pat. No. Des. 496,272, which is a division of application No. 29/165,907, filed on Aug. 20, 2002, now Pat. No. Des. 489,975.

(51) **LOC (7) Cl.** ..... **09-07**

(52) **U.S. Cl.** ..... **D9/425; D9/428; D9/429; D7/602**

(58) **Field of Search** ..... D9/424, 425, 428, D9/429, 430, 414; D3/304, 314; D7/587, 641, 602, 629; 206/503, 505, 557, 508, 566, 567; 220/656-659, 669-675, 556; 229/406, 407, 400, 938, 902-906; 426/106

(56) **References Cited**

**U.S. PATENT DOCUMENTS**

2,767,878	A	*	10/1956	Brown	.....	220/228
D257,107	S		9/1980	Daenen et al.	.....	D7/1
D276,400	S		11/1984	Daenen et al.	.....	D7/79
D276,401	S		11/1984	Daenen et al.	.....	D7/79
D276,402	S		11/1984	Daenen et al.	.....	D7/79

(List continued on next page.)

**OTHER PUBLICATIONS**

Color Photographs of Packaging No. 1; views 1-1 through 1-8; four pages; publicly available prior to Aug. 20, 2001.

(List continued on next page.)

*Primary Examiner*—Prabhakar Deshmukh

(74) *Attorney, Agent, or Firm*—Westman, Champlin & Kelly, P.A.

(57) **CLAIM**

The ornamental design for a food package, as shown and described.

**DESCRIPTION**

FIG. 1 is a perspective view of a first embodiment of the food package of the present invention;  
 FIG. 2 is a top plan view of the first embodiment;  
 FIG. 3 is a front elevational view of the first embodiment;  
 FIG. 4 is a right side elevational view of the first embodiment;  
 FIG. 5 is a left side elevational view of the first embodiment;  
 FIG. 6 is a rear elevational view of the first embodiment;  
 FIG. 7 is a bottom plan view of the first embodiment;  
 FIG. 8 is a perspective view of a second embodiment of the food package of the present invention;  
 FIG. 9 is a top plan view of the second embodiment;  
 FIG. 10 is a front elevational view of the second embodiment;  
 FIG. 11 is a right side elevational view of the second embodiment;  
 FIG. 12 is a left side elevational view of the second embodiment;  
 FIG. 13 is a rear elevational view of the second embodiment;  
 FIG. 14 is a bottom plan view of the second embodiment;  
 FIG. 15 is a perspective view of a third embodiment of the food package of the present invention;  
 FIG. 16 is a top plan view of the third embodiment;  
 FIG. 17 is a front elevational view of the third embodiment;  
 FIG. 18 is a right side elevational view of the third embodiment;  
 FIG. 19 is a left side elevational view of the third embodiment;  
 FIG. 20 is a rear elevational view of the third embodiment; and,  
 FIG. 21 is a bottom plan view of the third embodiment.

**1 Claim, 6 Drawing Sheets**

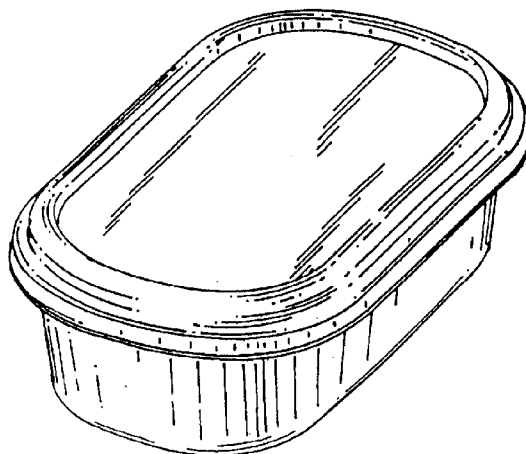

## U.S. PATENT DOCUMENTS

D285,906	S	*	9/1986	Tyler	.....	D9/425
D305,410	S	*	1/1990	Tyler	.....	D9/425
D312,968	S		12/1990	Wolff	.....	D9/431
5,029,725	A	*	7/1991	Roth	.....	220/655
D330,312	S		10/1992	Narsutis	.....	D7/629
5,503,886	A	*	4/1996	Guarriello et al.	.....	428/35.7
D371,962	S		7/1996	Peruzzi	.....	D9/423
D392,884	S		3/1998	Hayes	.....	D9/431
D418,055	S	*	12/1999	Veto	.....	D9/425
D428,310	S		7/2000	Zettle et al.	.....	D7/629
6,170,696	B1		1/2001	Tucker et al.	.....	220/793
D437,685	S		2/2001	Liu	.....	D3/294
D440,470	S		4/2001	Tucker et al.	.....	D7/629
D440,830	S		4/2001	Tucker et al.	.....	D7/629
D442,484	S		5/2001	Maxwell et al.	.....	D9/347
D443,184	S		6/2001	Maxwell et al.	.....	D7/629
D443,798	S		6/2001	Tucker et al.	.....	D7/629
D445,311	S		7/2001	Emonet et al.	.....	D7/629
D445,649	S		7/2001	Maxwell et al.	.....	D7/629
D445,650	S		7/2001	Maxwell et al.	.....	D7/629
D446,077	S		8/2001	Tucker et al.	.....	D7/392.1
D447,382	S		9/2001	Tucker et al.	.....	D7/392.1
D449,495	S		10/2001	Tucker et al.	.....	D7/629
D450,983	S		11/2001	Tucker et al.	.....	D7/629
D451,769	S		12/2001	Stanos et al.	.....	D7/629
D456,713	S		5/2002	Bried et al.	.....	D9/449
D462,880	S		9/2002	Maxwell et al.	.....	D7/629
6,467,647	B1		10/2002	Tucker et al.	.....	220/793
6,557,720	B2	*	5/2003	Tosdale et al.	.....	220/657

## OTHER PUBLICATIONS

Color Photographs of Packaging No. 2 views 2–1 through 2–8; four pages; publicly available prior to Aug. 20, 2001.  
 Color Photographs of Packaging No. 3; views 3–1 through 3–9; five pages; publicly available prior to Aug. 20, 2001.  
 Color Photographs of Packaging No. 4; views 4–1 through 4–5; three pages; publicly available prior to Aug. 20, 2001.  
 Color Photographs of Packaging No. 5; views 5–1 through 5–5; three pages; publicly available prior to Aug. 20, 2001.  
 Color Photographs of Packaging No. 6; views 6–1 through 6–9; five pages; publicly available prior to Aug. 20, 2001.  
 Color Photographs of Packaging No. 7; views 7–1 through 7–9; five pages; publicly available prior to Aug. 20, 2001.  
 Color Photographs of Packaging No. 8; views 8–1 through 8–9; five pages; publicly available prior to Aug. 20, 2001.  
 Color Photographs of Packaging No. 9; views 9–1 through 9–9; five pages; publicly available prior to Aug. 20, 2001.  
 Color Photographs of Packaging No. 10; views 10–1 through 10–5; three pages; publicly available prior to Aug. 20, 2001.  
 Color Photographs of Packaging No. 11; views 11–1 through 11–5; three pages; publicly available prior to Aug. 20, 2001.  
 Color Photographs of Packaging No. 12; views 12–1 through 12–9; five pages; publicly available prior to Aug. 20, 2001.

Color Photographs of Packaging No. 13; views 13–1 through 13–9; five pages; publicly available prior to Aug. 20, 2001.

Color Photographs of Packaging No. 14; views 14–1 through 14–5; three pages; publicly available prior to Aug. 20, 2001.

Color Photographs of Packaging No. 15; views 15–1 through 15–5; three pages; publicly available prior to Aug. 20, 2001.

Color Photographs of Packaging No. 16; views 16–1 through 16–9; five pages; publicly available prior to Aug. 20, 2001.

Color Photographs of Packaging No. 17; views 17–1 through 17–9; five pages; publicly available prior to Aug. 20, 2001.

Color Photographs of Packaging No. 18; views 18–1 through 18–5; three pages; publicly available prior to Aug. 20, 2001.

Color Photographs of Packaging No. 19; views 19–1 through 19–9; five pages; publicly available prior to Aug. 20, 2001.

Color Photographs of Packaging No. 20; views 20–1 through 20–5; three pages; publicly available prior to Aug. 20, 2001.

Color Photographs of Packaging No. 21; views 21–1 through 21–9; five pages; publicly available prior to Aug. 20, 2001.

Color Photographs of Packaging No. 22; views 22–1 through 22–9; five pages; publicly available prior to Aug. 20, 2001.

Color Photographs of Packaging No. 23; views 23–1 through 23–5; three pages; publicly available prior to Aug. 20, 2001.

Color Photographs of Packaging No. 24; views 24–1 through 24–9; five pages; publicly available prior to Aug. 20, 2001.

Color Photographs of Packaging No. 25; views 25–1; one page; publicly available prior to Aug. 20, 2001.

Color Photographs of Packaging No. 26; views 26–1 through 26–5; three pages; publicly available prior to Aug. 20, 2001.

Color Photographs of Packaging No. 27; views 27–1 through 27–9; five pages; publicly available prior to Aug. 20, 2001.

Color Photographs of Packaging No. 28; views 28–1 through 28–9; five pages; publicly available prior to Aug. 20, 2001.

Color Photographs of Packaging No. 29; views 29–1 through 29–5; three pages; publicly available prior to Aug. 20, 2001.

\* cited by examiner

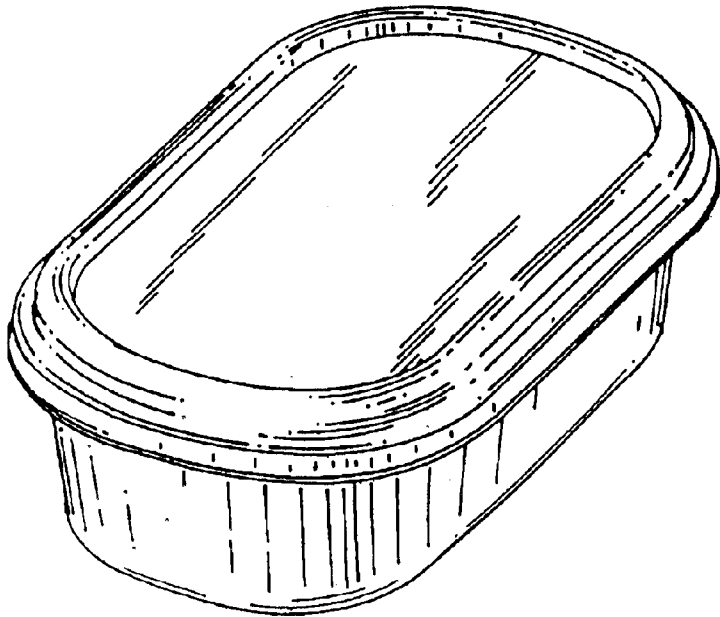

*Fig. 1*

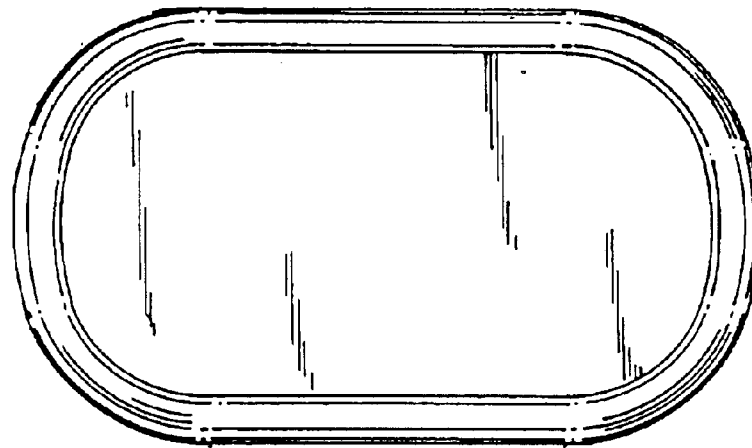

*Fig. 2*

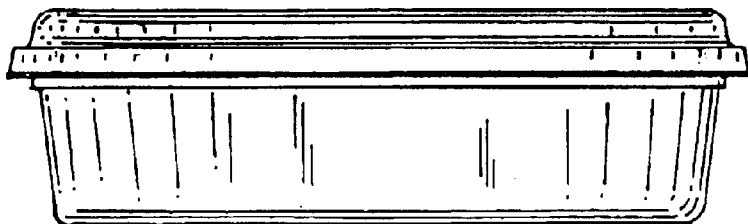

*Fig. 3*

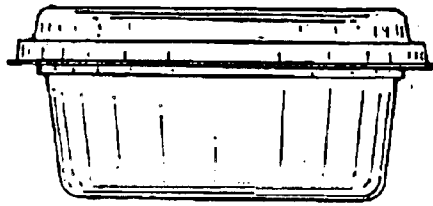

*Fig. 4*

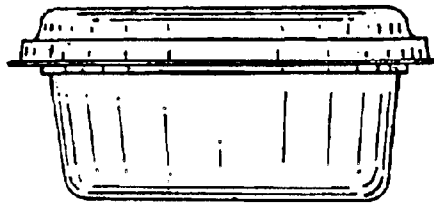

*Fig. 5*

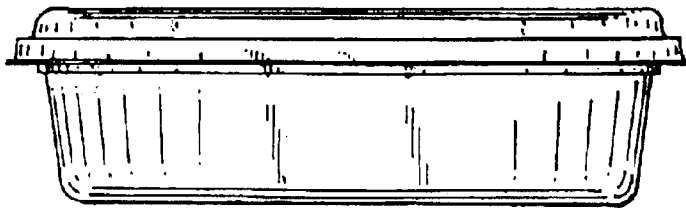

*Fig. 6*

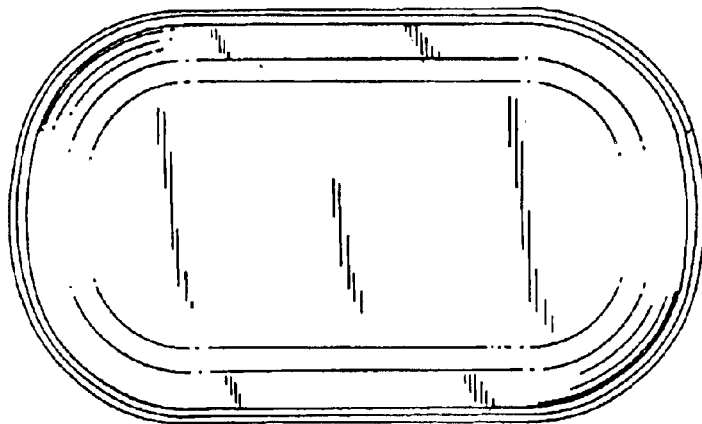

*Fig. 7*

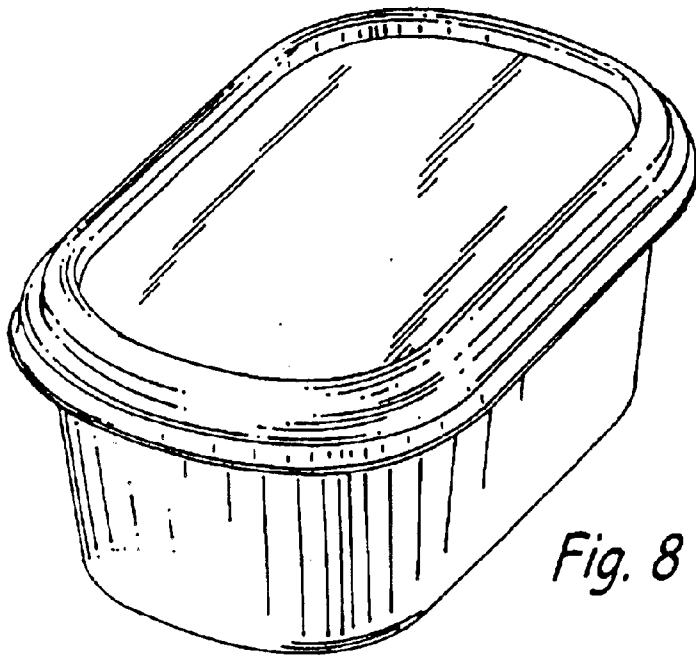

*Fig. 8*

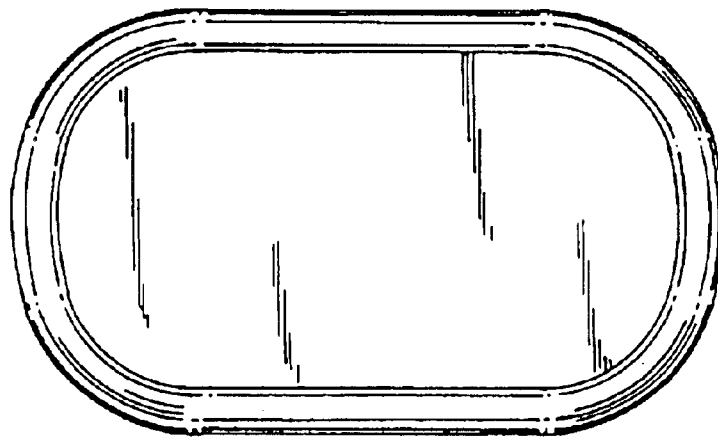

*Fig. 9*

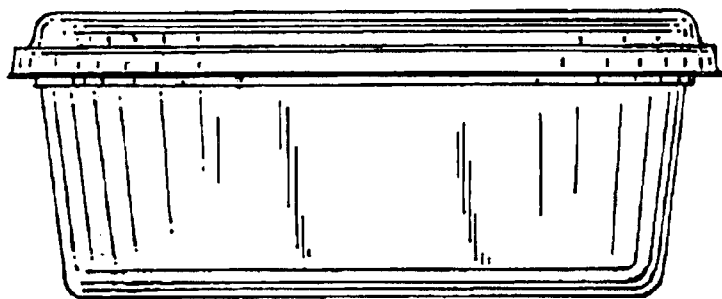

*Fig. 10*

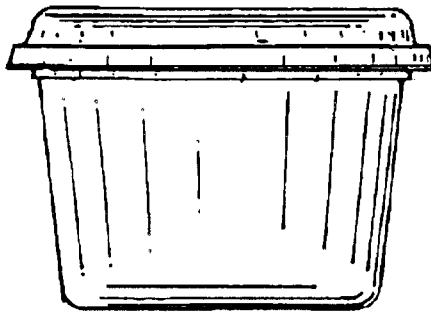

*Fig. 11*

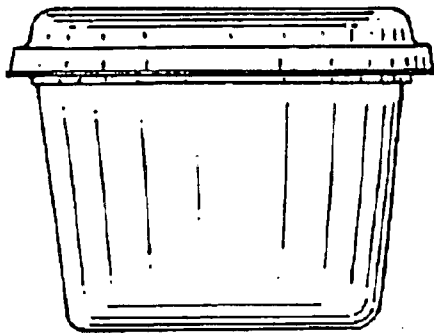

*Fig. 12*

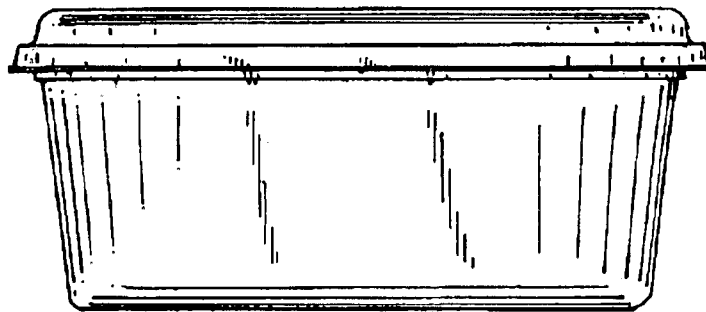

*Fig. 13*

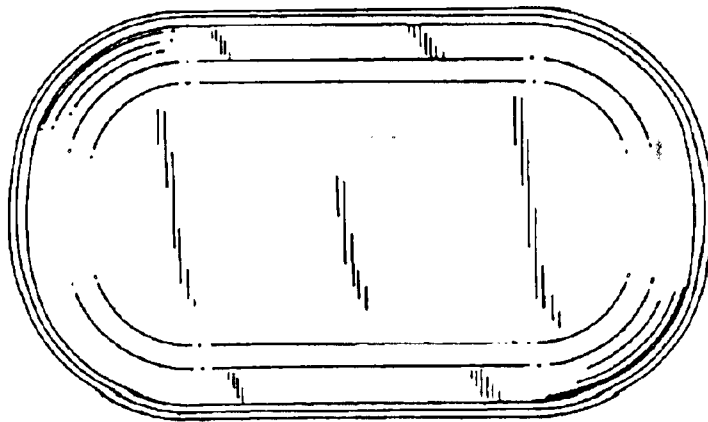

*Fig. 14*

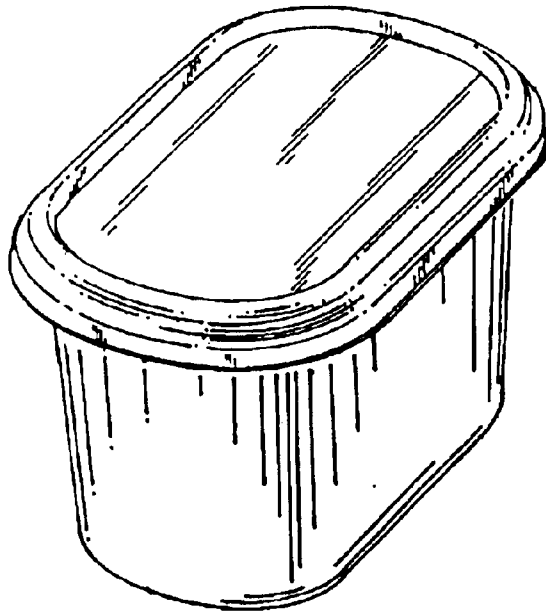

*Fig. 15*

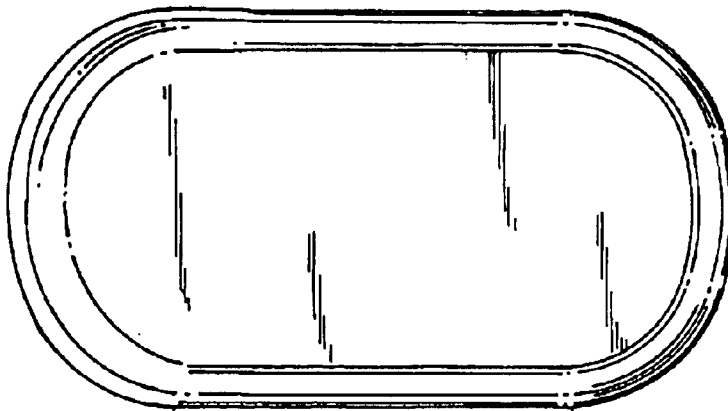

*Fig. 16*

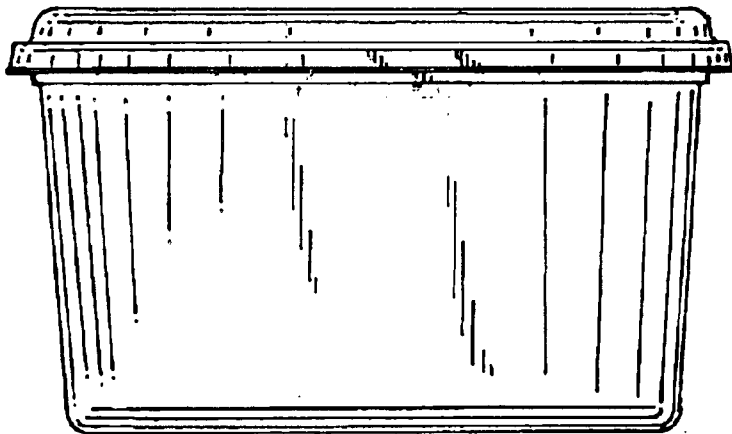

*Fig. 17*

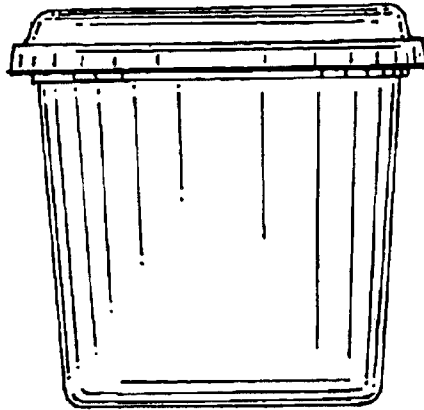

*Fig. 18*

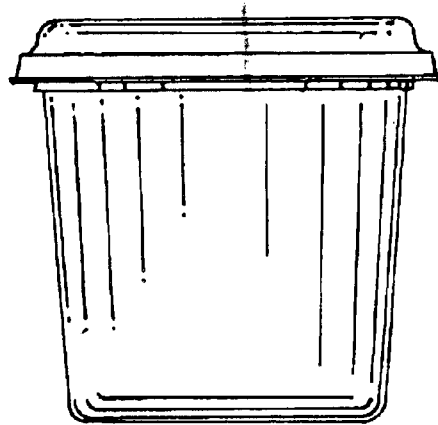

*Fig. 19*

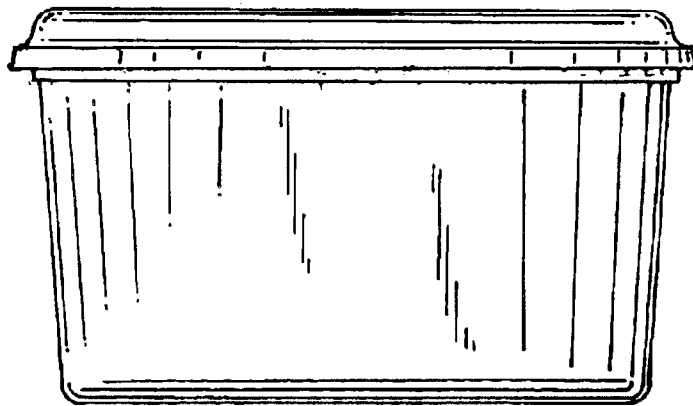

*Fig. 20*

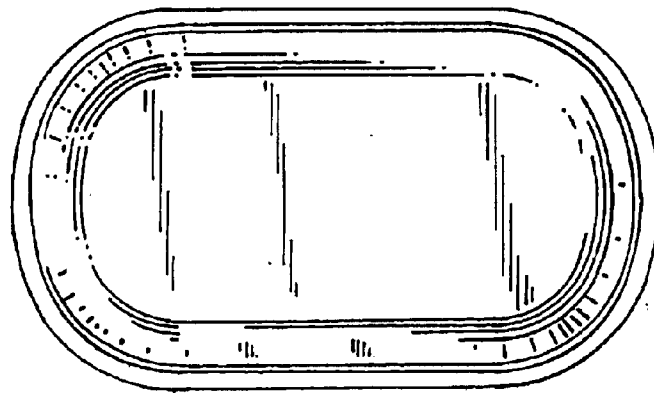

*Fig. 21*