



US0D1033360S

(12) **United States Design Patent**
Horino

(10) **Patent No.:** **US D1,033,360 S**

(45) **Date of Patent:** **** Jul. 2, 2024**

(54) **ELECTRICAL CONNECTOR**

(71) Applicant: **Kyocera Corporation**, Kyoto (JP)

(72) Inventor: **Shintaro Horino**, Yokohama (JP)

(73) Assignee: **KYOCERA CORPORATION**, Kyoto (JP)

(**) Term: **15 Years**

(21) Appl. No.: **29/825,074**

(22) Filed: **Jan. 28, 2022**

(30) **Foreign Application Priority Data**

Dec. 6, 2021 (JP) 2021-026824 D

(51) **LOC (14) Cl.** **13-03**

(52) **U.S. Cl.**
USPC **D13/147**

(58) **Field of Classification Search**

USPC D13/110, 123, 133, 146, 147, 149, 154,
D13/173, 178, 182, 184, 199

CPC H01R 12/00; H01R 12/70; H01R 12/716;
H01R 12/73; H01R 13/24; H01R 13/42;
H01R 13/426; H01R 13/631

See application file for complete search history.

(56) **References Cited**

U.S. PATENT DOCUMENTS

D603,798 S *	11/2009	Obikane	D13/147
D603,801 S *	11/2009	Obikane	D13/147
D642,532 S *	8/2011	Nishimura	D13/147
D642,533 S *	8/2011	Nishimura	D13/147
D642,535 S *	8/2011	Sato	D13/147

(Continued)

Primary Examiner — Christy Nemeth

Assistant Examiner — Justin M. Donaldson

(74) *Attorney, Agent, or Firm* — Sughrue Mion, PLLC

(57) **CLAIM**

The ornamental design for an electrical connector, as shown and described.

DESCRIPTION

FIG. 1 is a front, bottom and left-side perspective view of an electrical connector showing my new design;

FIG. 2 is a front perspective view thereof;

FIG. 3 is a rear perspective view thereof;

FIG. 4 is a front elevational view thereof;

FIG. 5 is a rear elevational view thereof;

FIG. 6 is a left-side elevational view thereof;

FIG. 7 is a right-side elevational view thereof;

FIG. 8 is a top plan view thereof;

FIG. 9 is a bottom plan view thereof;

FIG. 10 is an enlarged partial view of the area 10 indicated in FIG. 1;

FIG. 11 is an enlarged partial view of the area 11 indicated in FIG. 2;

FIG. 12 is an enlarged partial view of the area 12 indicated in FIG. 3;

FIG. 13 is an enlarged cross-sectional view taken along line 13-13 in FIG. 4;

FIG. 14 is an enlarged cross-sectional view taken along line 14-14 in FIG. 4;

FIG. 15 is an enlarged cross-sectional view taken along line 15-15 in FIG. 4;

FIG. 16 is an enlarged partial view of the area 16 indicated in FIG. 4; and,

FIG. 17 is an enlarged partial view of the area 17 indicated in FIG. 5.

The dash-dash broken lines illustrate portions of the electrical connector that form no part of the claimed design.

Also, the dash-dash broken lines in FIG. 13, FIG. 14 and FIG. 15 depict the surfaces at the cut marks and form no part of the claimed design.

The dot-dash broken lines illustrate the boundary of the claimed design and form no part of the claimed design.

The dot-dot-dash broken lines illustrate the boundary of the portions shown enlarged and form no part of the claimed design.

1 Claim, 15 Drawing Sheets

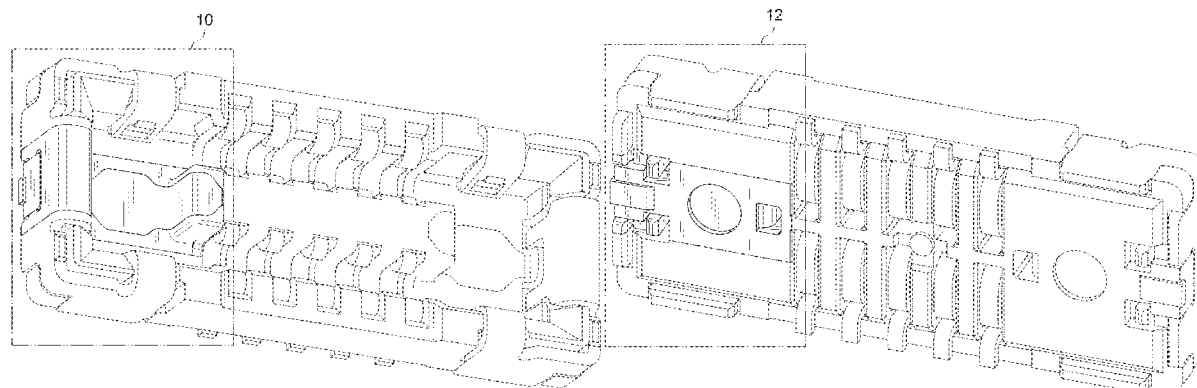

(56)

References Cited

U.S. PATENT DOCUMENTS

D642,986	S *	8/2011	Nishimura	D13/147	D744,429	S *	12/2015	Kobuchi	D13/147
D683,317	S *	5/2013	Nishimura	D13/147	D745,463	S *	12/2015	Kobuchi	D13/147
D684,120	S *	6/2013	Miyazaki	D13/147	D748,583	S *	2/2016	Kobuchi	D13/147
D687,382	S *	8/2013	Miyazaki	D13/147	D767,499	S *	9/2016	Goto	D13/147
D687,383	S *	8/2013	Miyazaki	D13/147	D774,463	S *	12/2016	Omodachi	D13/147
D688,210	S *	8/2013	Mashiyama	D13/147	D793,342	S *	8/2017	Ashibu	D13/147
D691,960	S *	10/2013	Miyazaki	D13/147	D793,961	S *	8/2017	Ueda	D13/147
D692,833	S *	11/2013	Nishimura	D13/147	D795,197	S *	8/2017	Ueda	D13/147
D695,691	S *	12/2013	Kobuchi	D13/147	D816,043	S *	4/2018	Ashibu	D13/147
D696,201	S *	12/2013	Takenaga	D13/147	D824,336	S *	7/2018	Yayoshi	D13/147
D703,146	S *	4/2014	Takenaga	D13/147	D824,339	S *	7/2018	Yamaguchi	D13/147
D720,298	S *	12/2014	Takenaga	D13/147	D828,307	S *	9/2018	Ashibu	D13/147
D721,040	S *	1/2015	Watanabe	D13/147	D866,477	S *	11/2019	Takenaga	D13/147
D722,564	S *	2/2015	Yoshida	D13/147	D885,347	S *	5/2020	Ishida	D13/147
D722,972	S *	2/2015	Miyazaki	D13/147	D893,434	S *	8/2020	Ishida	D13/147
D722,973	S *	2/2015	Miyazaki	D13/147	D894,842	S *	9/2020	Ashibu	D13/147
D722,974	S *	2/2015	Ueda	D13/147	D911,977	S *	3/2021	Ashibu	D13/147
D723,471	S *	3/2015	Miyazaki	D13/147	D922,959	S *	6/2021	Oosaka	D13/147
D735,674	S *	8/2015	Miyazaki	D13/147	D933,613	S *	10/2021	Takenaga	D13/147
D735,675	S *	8/2015	Yoshioka	D13/147	D977,435	S *	2/2023	Omodachi	D13/133
D737,213	S *	8/2015	Yoshioka	D13/147	D985,511	S *	5/2023	Kan	D13/147
D739,826	S *	9/2015	Omodachi	D13/147	D986,176	S *	5/2023	Kobuchi	D13/133
D743,344	S *	11/2015	Kobuchi	D13/147	D987,576	S *	5/2023	Omodachi	D13/147
D743,905	S *	11/2015	Kobuchi	D13/147	2023/0104947	A1 *	4/2023	Oh	H01R 13/6591 439/74
						2023/0246368	A1 *	8/2023	Yayoshi	H01R 13/64 439/660

* cited by examiner

FIG. 1

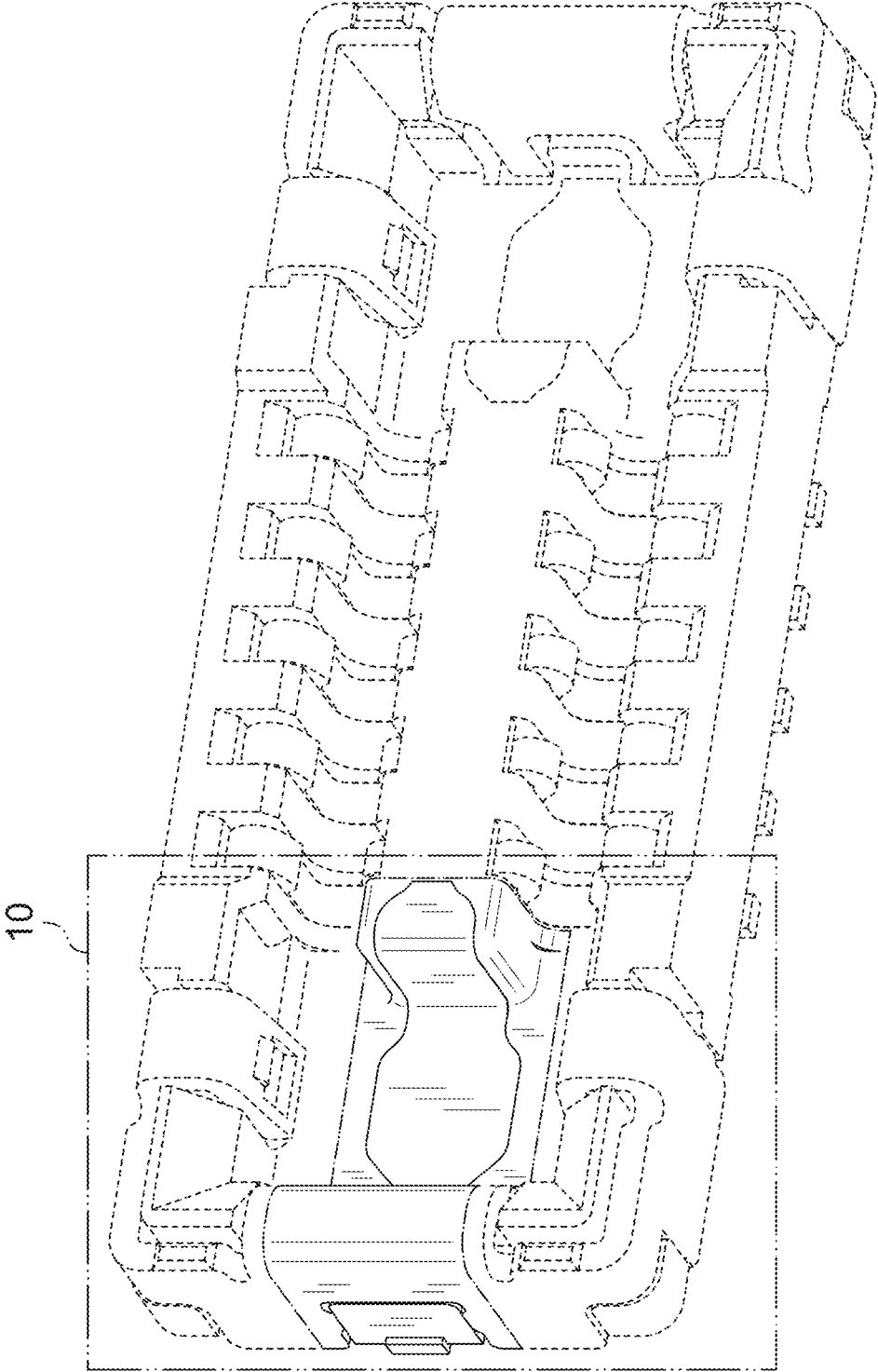

FIG. 2

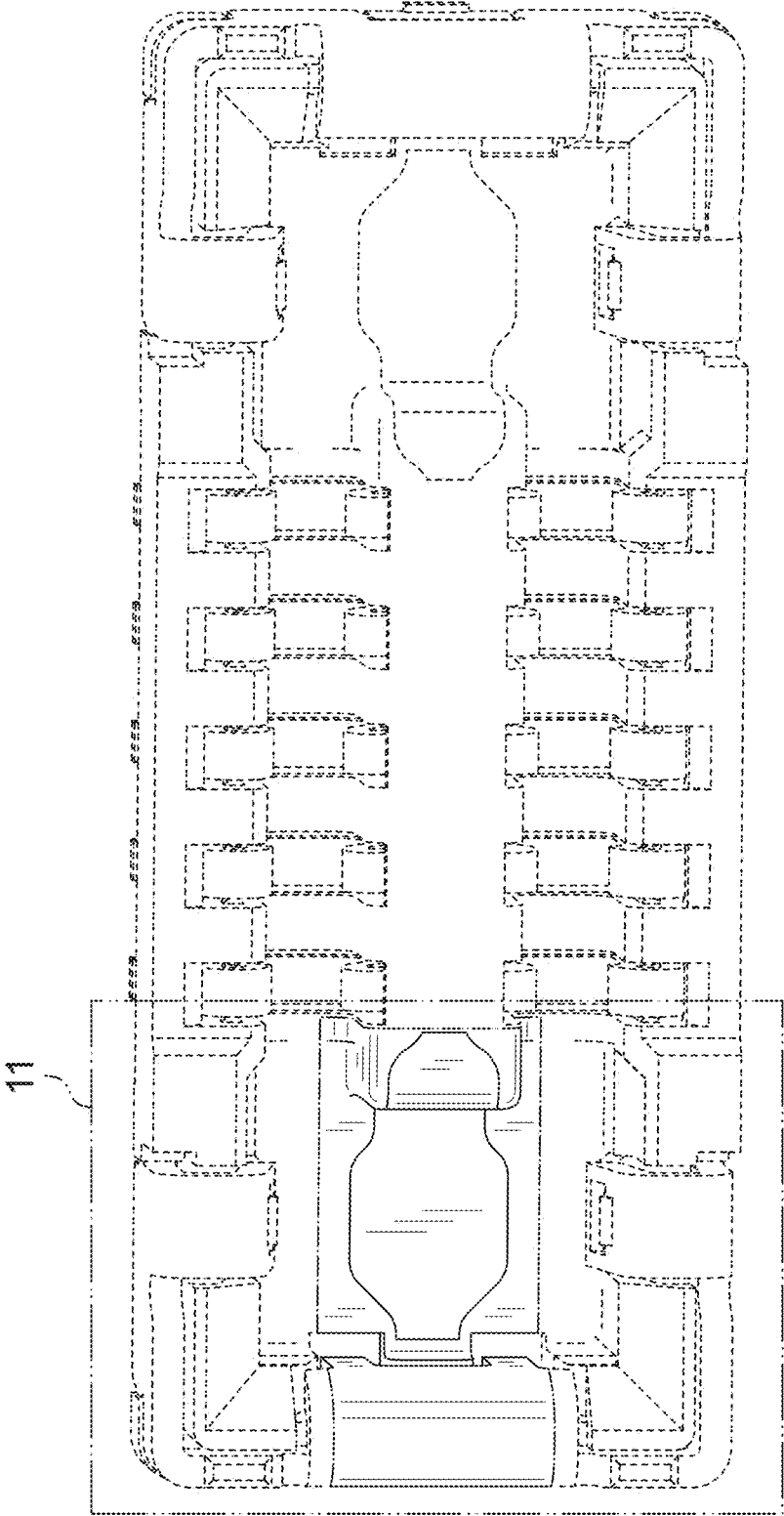

FIG. 3

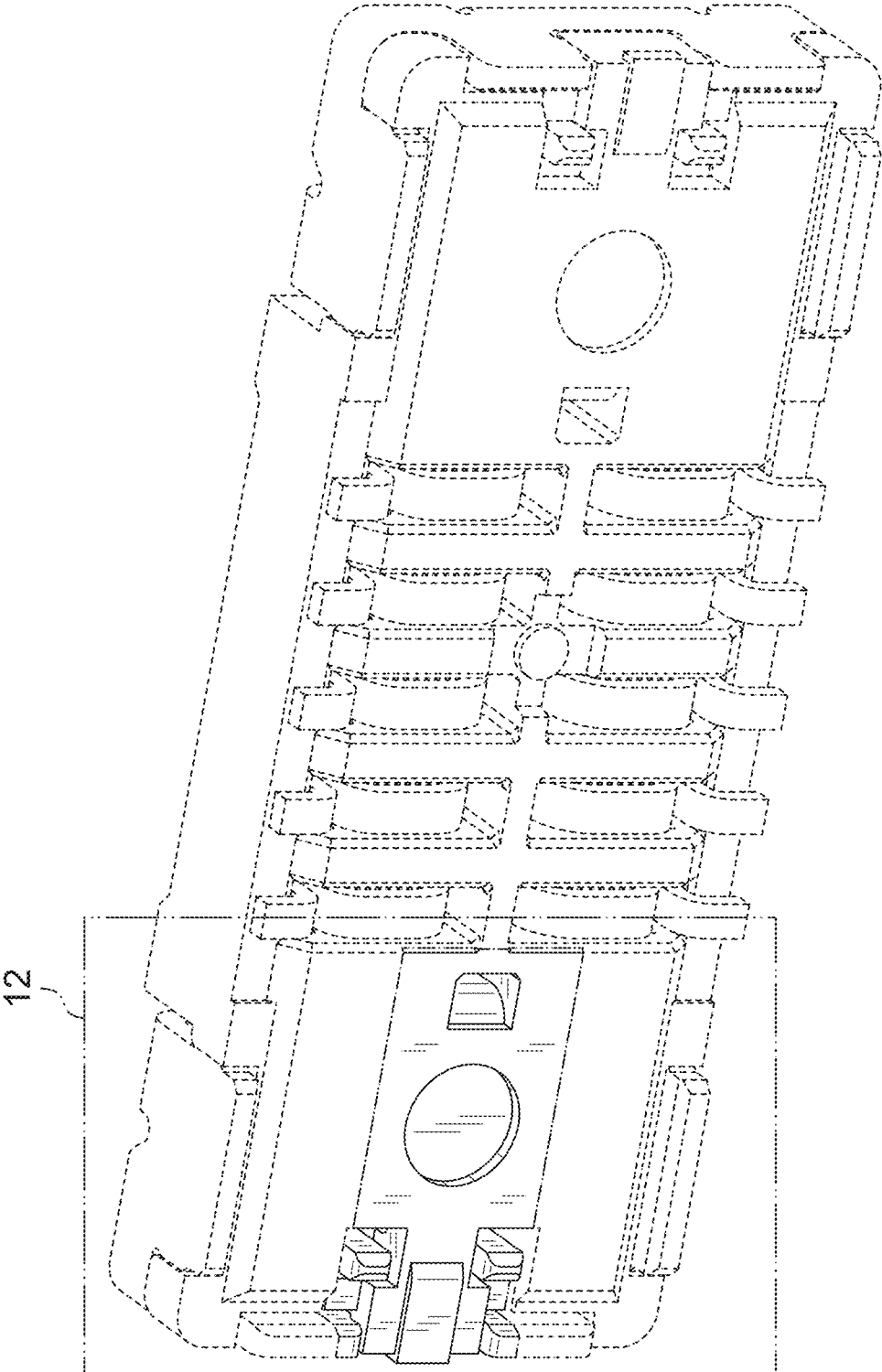

FIG. 4

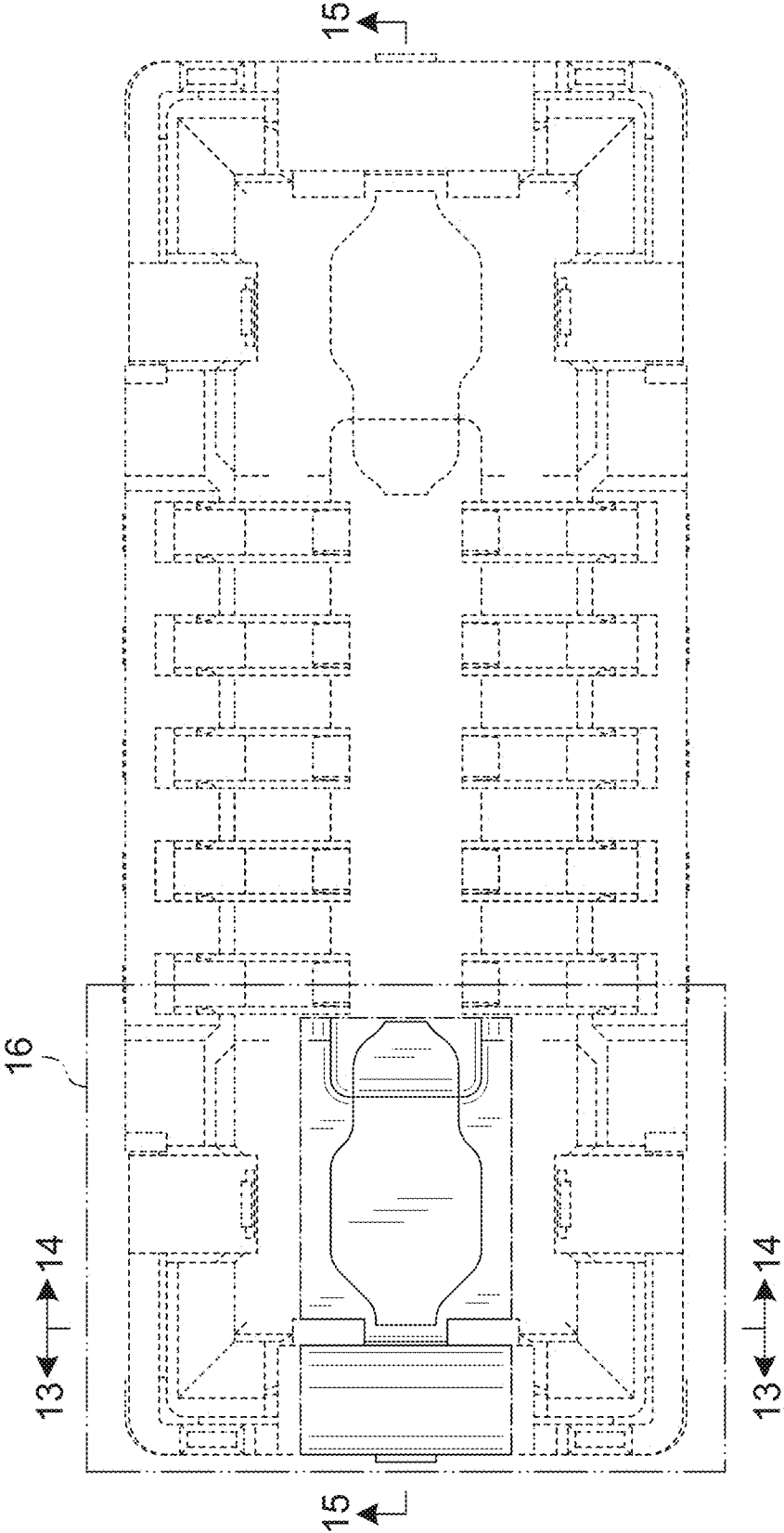

FIG. 5

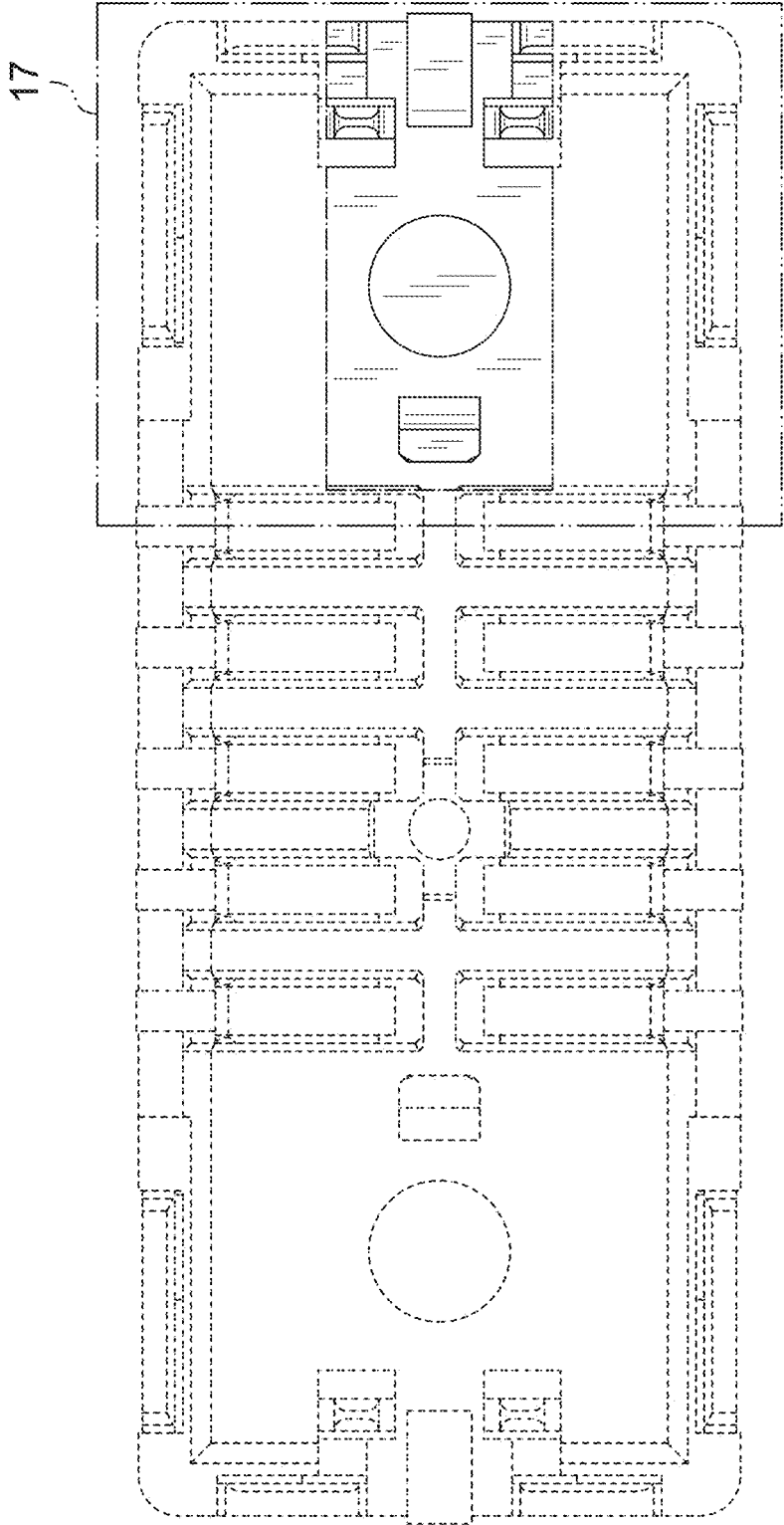

FIG. 6

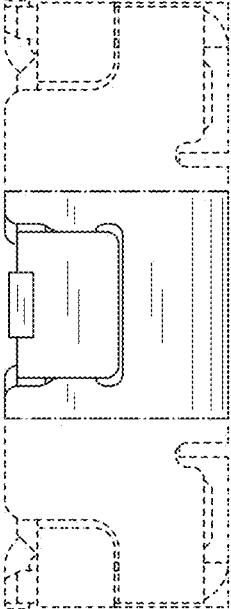

FIG. 7

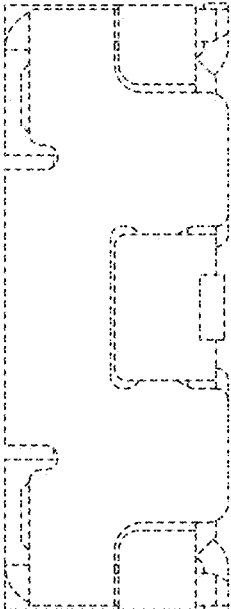

FIG. 8

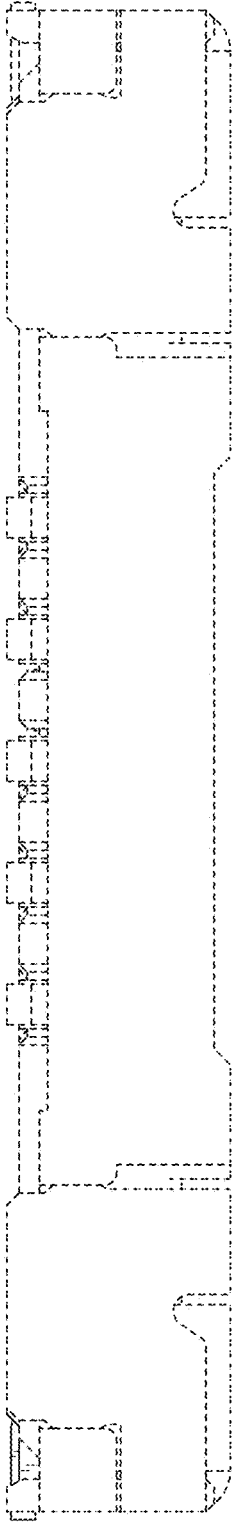

FIG. 9

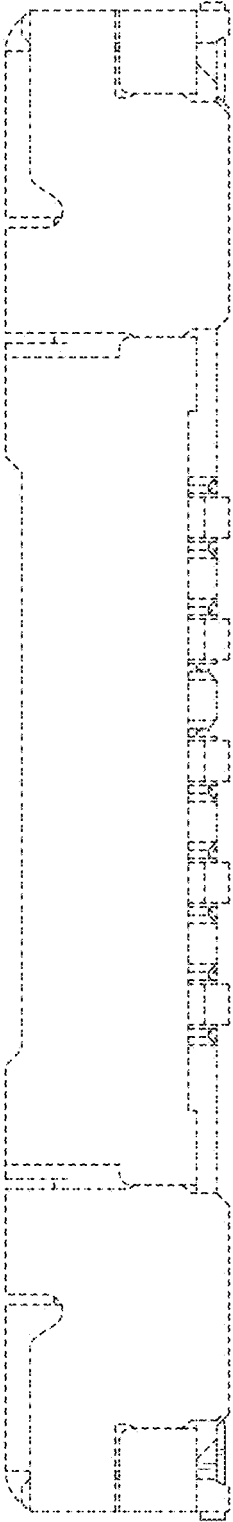

FIG. 10

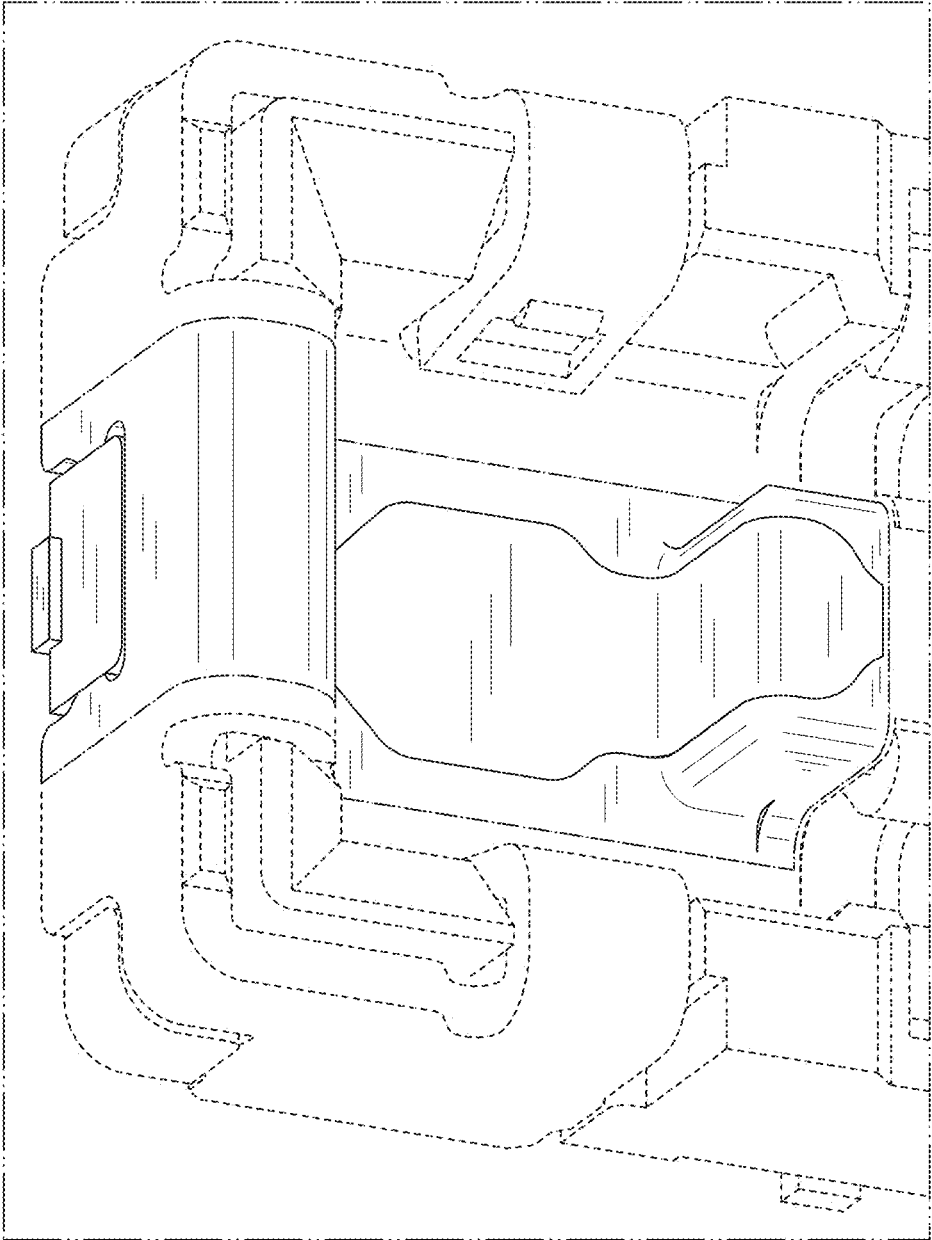

FIG. 11

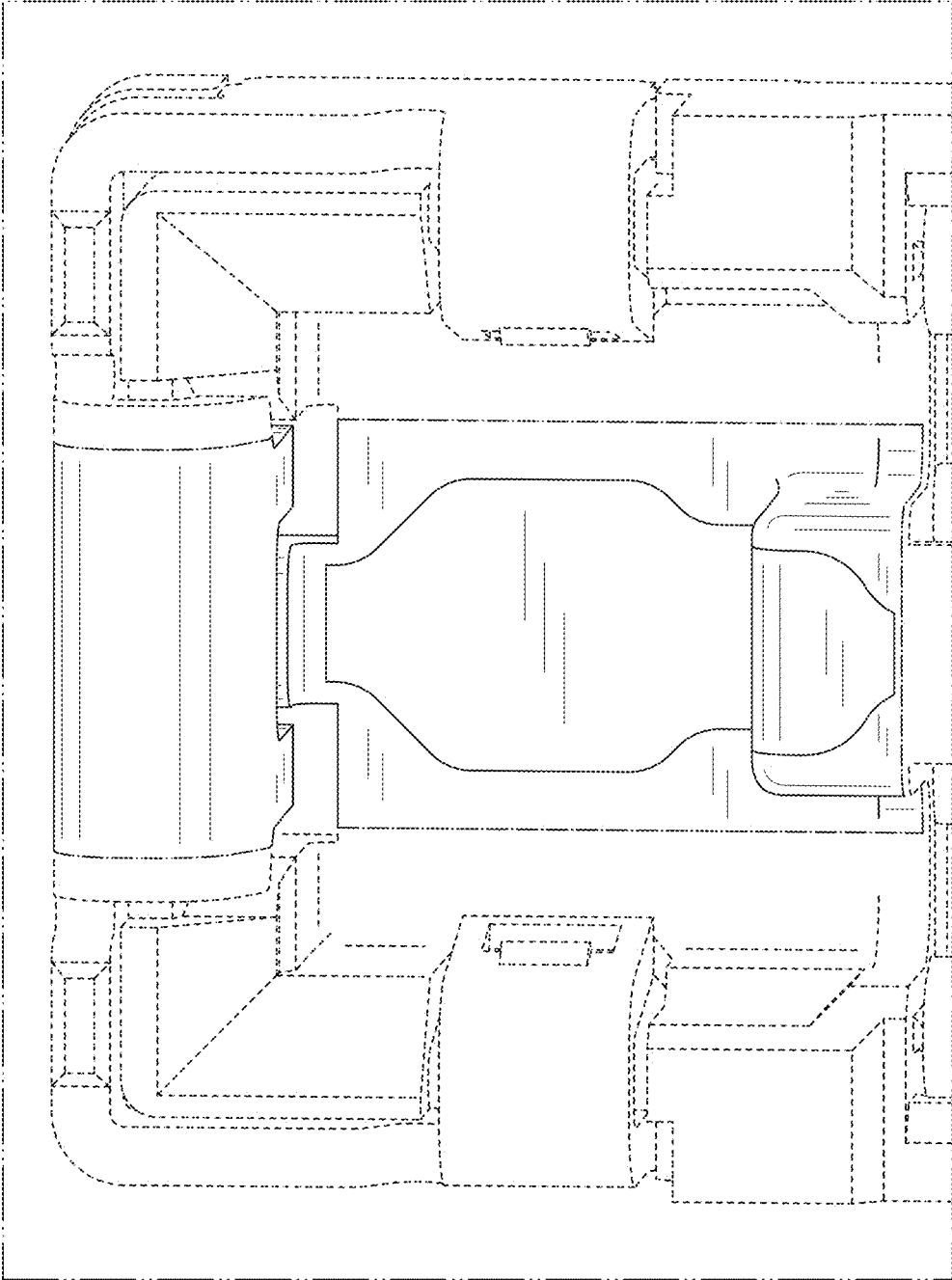

FIG. 12

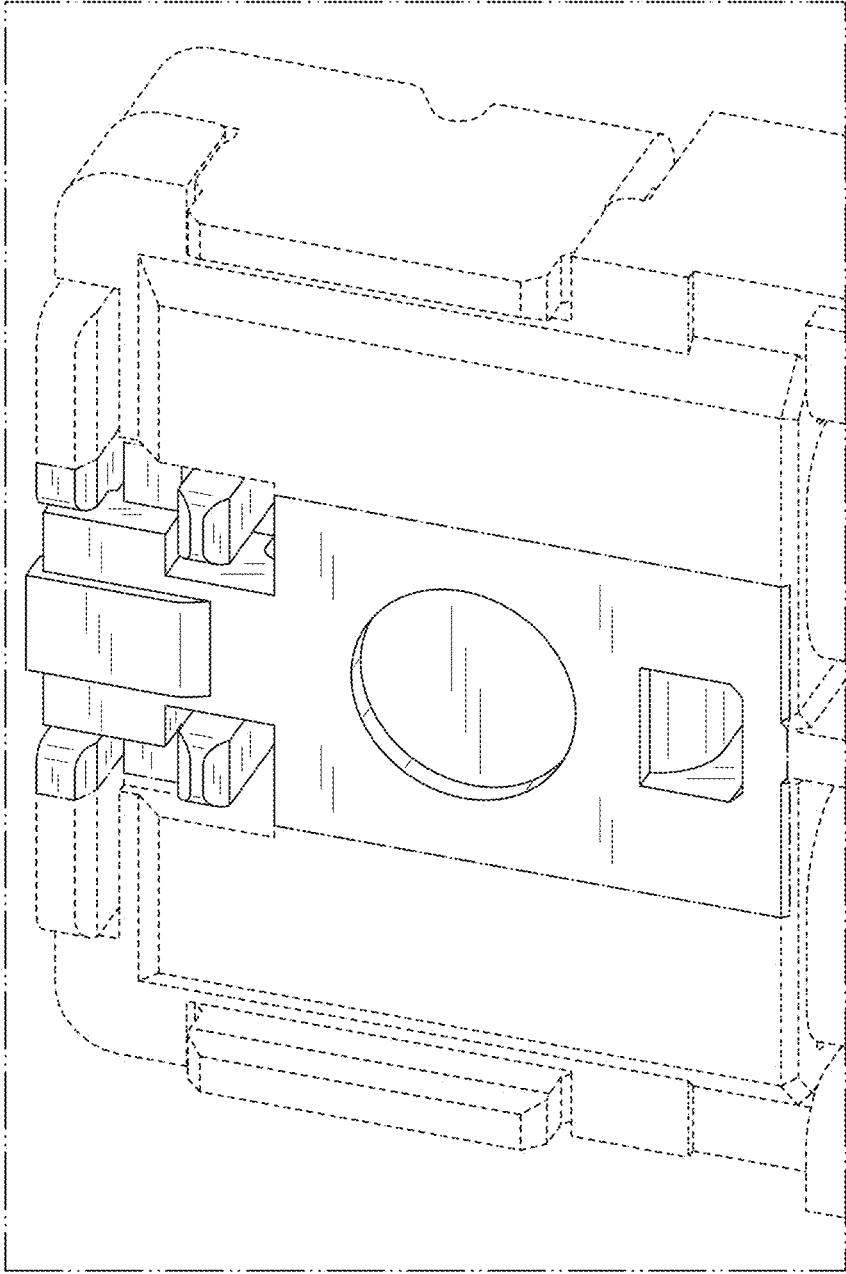

FIG. 13

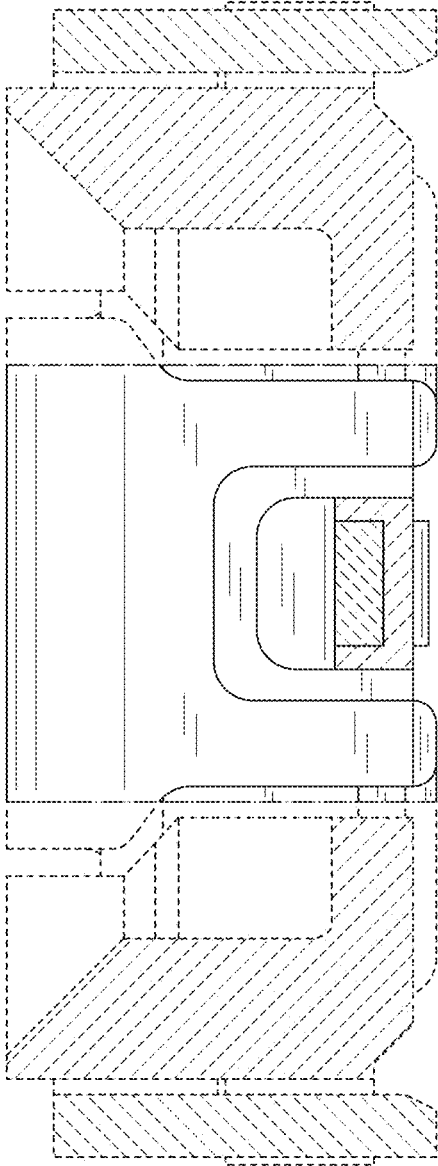

FIG. 14

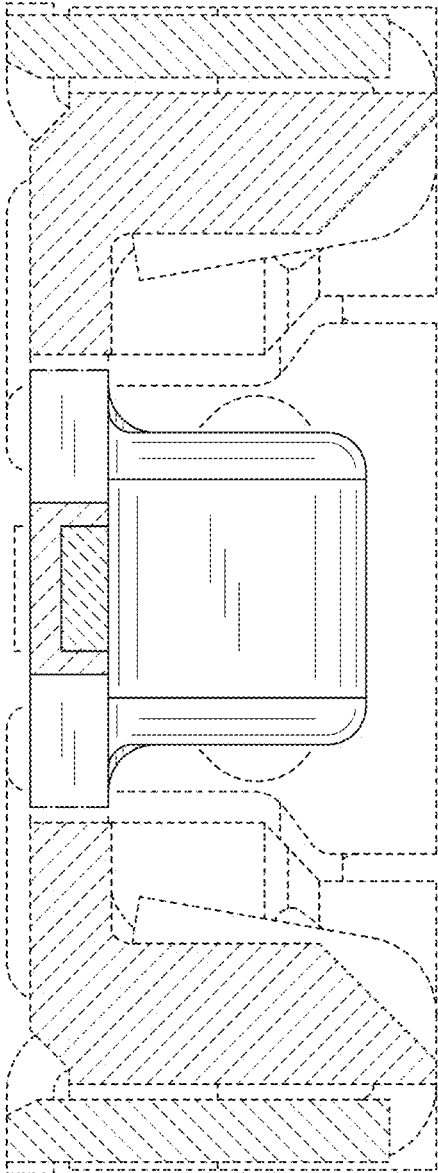

FIG. 15

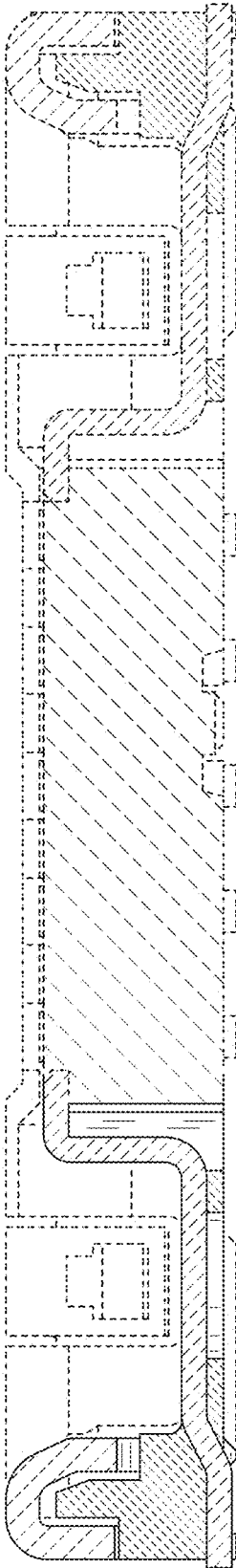

FIG. 16

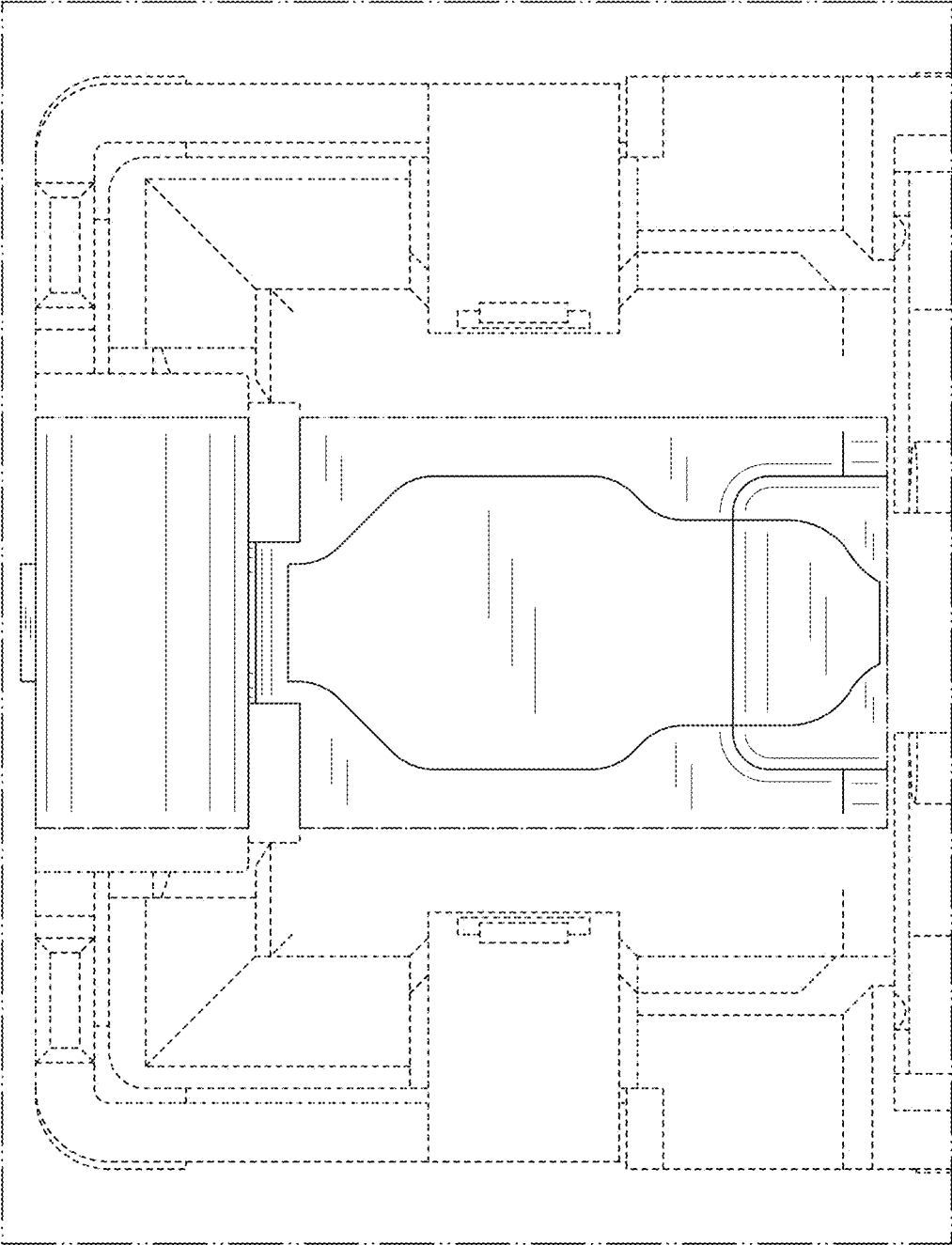

FIG. 17

