



US00D681727S

(12) **United States Design Patent**  
**Van Den Broecke**

(10) **Patent No.:** **US D681,727 S**

(45) **Date of Patent:** **\*\* May 7, 2013**

(54) **CASSETTE**

(75) Inventor: **Stefaan Van Den Broecke**, Ghent (BE)

(73) Assignee: **DYMO**, Sint-Niklaas (BE)

(\*\*) Term: **14 Years**

(21) Appl. No.: **29/377,899**

(22) Filed: **Oct. 27, 2010**

(30) **Foreign Application Priority Data**

Apr. 28, 2010 (EM) ..... 001212104

(51) **LOC (9) Cl.** ..... **18-02**

(52) **U.S. Cl.**  
USPC ..... **D18/56**

(58) **Field of Classification Search** ..... D18/12,  
D18/43, 56; 400/194-196, 207-208, 234,  
400/235.1, 247; 360/132

See application file for complete search history.

(56) **References Cited**

**U.S. PATENT DOCUMENTS**

5,674,017	A *	10/1997	Kitazawa	.....	400/207
D423,566	S *	4/2000	Hosono	.....	D18/56
D435,589	S *	12/2000	Huss	.....	D18/56
6,341,906	B2 *	1/2002	Kobayashi et al.	.....	400/207
6,367,995	B1 *	4/2002	Hashimoto et al.	.....	400/207

\* cited by examiner

*Primary Examiner* — Cathy A MacCormac

(74) *Attorney, Agent, or Firm* — Marshall, Gerstein & Borun LLP

(57) **CLAIM**

The ornamental design for a cassette, as shown and described.

**DESCRIPTION**

FIG. 1 is a front, top and left side perspective view showing my new design for a cassette;

FIG. 2 is a rear, top and left side perspective view of the cassette of FIG. 1;

FIG. 3 is a rear view of the cassette of FIG. 1;

FIG. 4 is a right side view of the cassette of FIG. 1;

FIG. 5 is a top plan view of the cassette of FIG. 1;

FIG. 6 is a bottom plan view of the cassette of FIG. 1;

FIG. 7 is an enlarged partial view of the left side of the cassette of FIG. 1;

FIG. 8 is a front, top and left side perspective view showing a second embodiment of my new design for a cassette;

FIG. 9 is a rear, top and left side perspective view of the cassette of FIG. 8;

FIG. 10 is a front view of the cassette of FIG. 8;

FIG. 11 is a rear view of the cassette of FIG. 8;

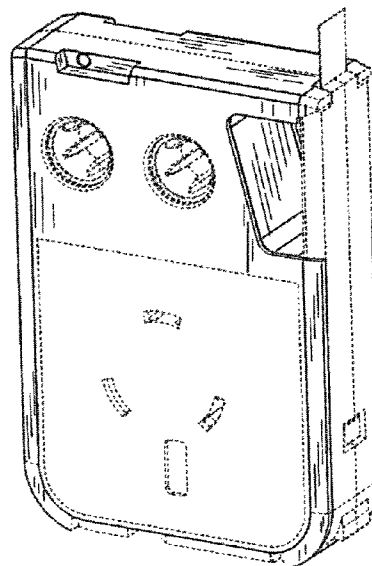
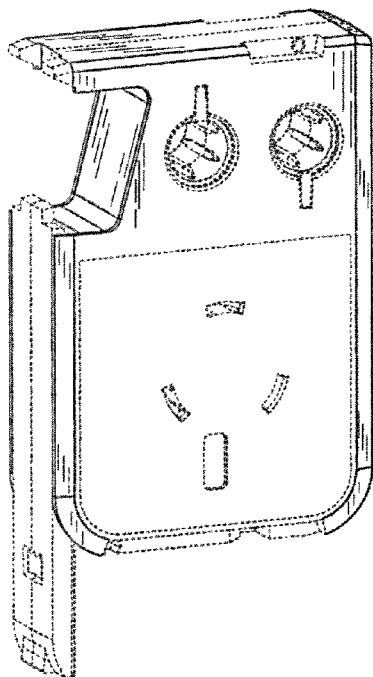
FIG. 12 is a right side view of the cassette of FIG. 8;

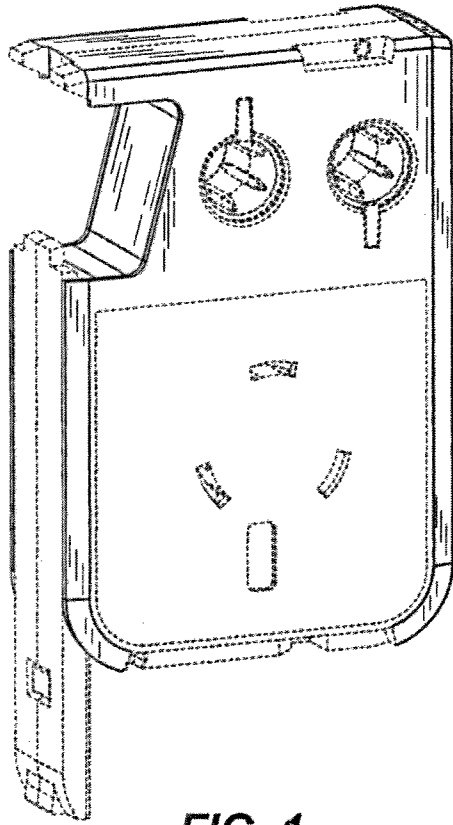
FIG. 13 is a top plan view of the cassette of FIG. 8; and,

FIG. 14 is a bottom plan view of the cassette of FIG. 8.

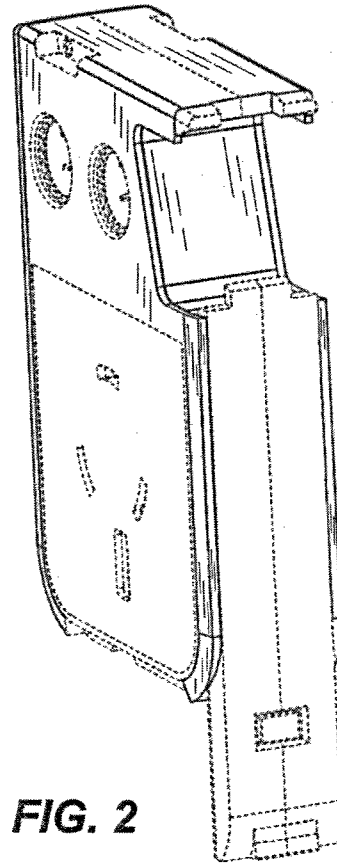
The broken lines showing portions of the cassette are included for the purpose of illustrating environment and form no part of the claimed design.

**1 Claim, 6 Drawing Sheets**

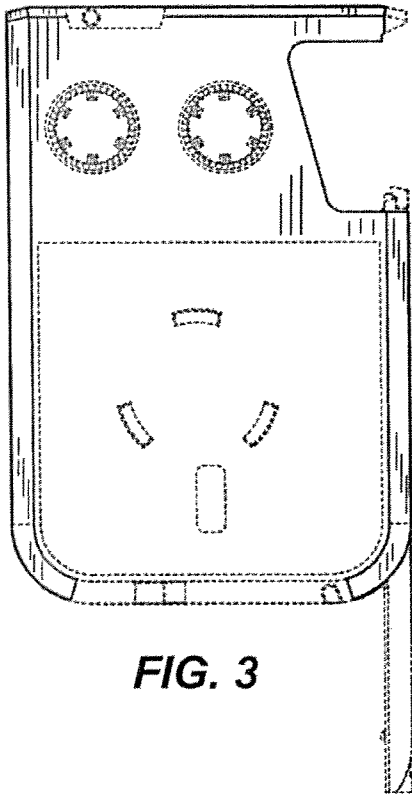




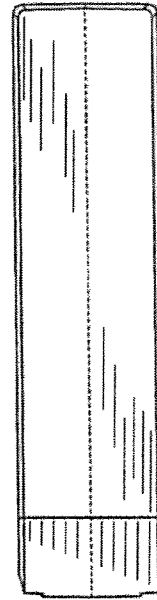
**FIG. 1**



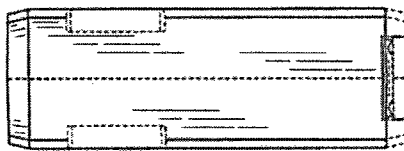
**FIG. 2**



**FIG. 3**



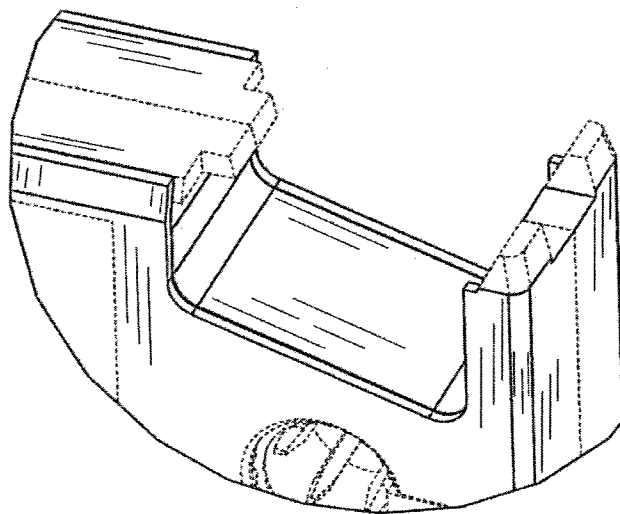
**FIG. 4**



**FIG. 5**



**FIG. 6**



**FIG. 7**

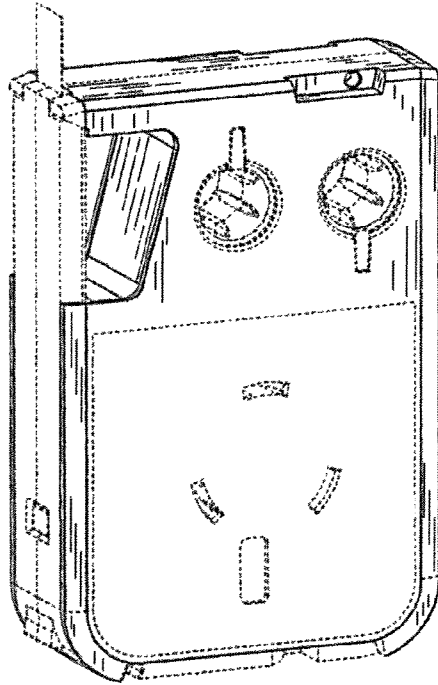


FIG. 8

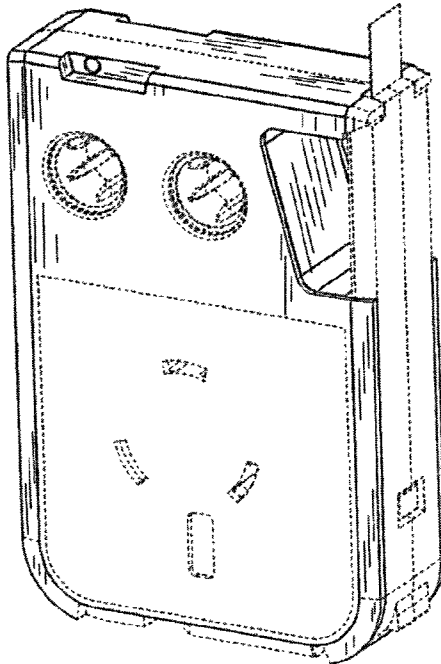
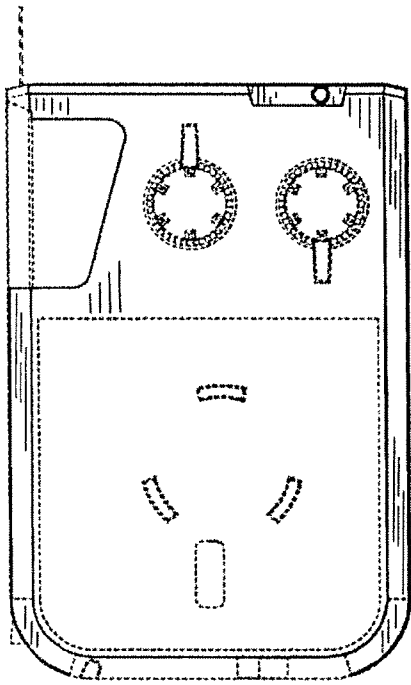
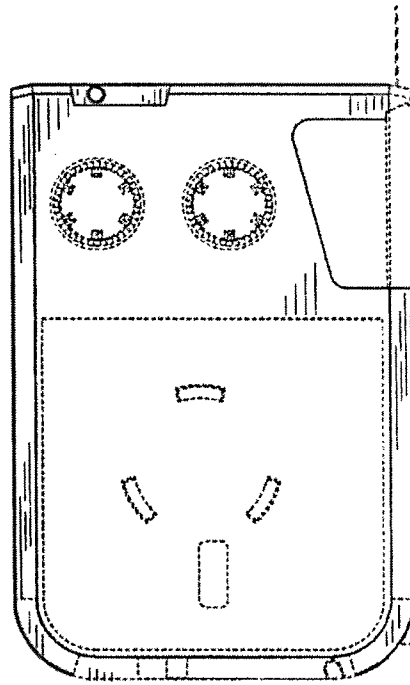


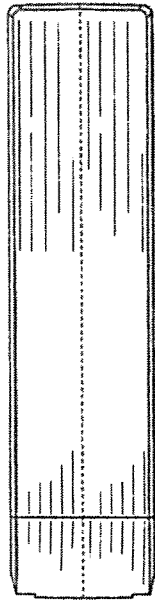
FIG. 9



**FIG. 10**



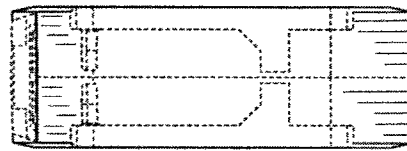
**FIG. 11**



**FIG. 12**



**FIG. 13**



**FIG. 14**