



US00D438418S

(12) **United States Design Patent**
Myszka et al.

(10) **Patent No.:** **US D438,418 S**

(45) **Date of Patent:** **** Mar. 6, 2001**

(54) **STORAGE CONTAINER FOR DISC-SHAPED ITEM OF RECORDED MEDIA**

6,065,593 * 5/2000 Howerton et al. 206/310

* cited by examiner

(75) Inventors: **Kevin E. Myszka**, Kent; **James M. Byrne**, Massillon; **James N. Peterson**, North Canton, all of OH (US)

Primary Examiner—Celia Murphy
(74) *Attorney, Agent, or Firm*—Sand & Sebolt

(73) Assignee: **Nexpak Corporation**, North Canton, OH (US)

(57) **CLAIM**

(**) Term: **14 Years**

We claim the ornamental design for a storage container for disc-shaped item of recorded media, as shown and described.

(21) Appl. No.: **29/124,345**

DESCRIPTION

(22) Filed: **Jun. 2, 2000**

(51) **LOC (7) Cl.** **06-04**

(52) **U.S. Cl.** **D6/634**

(58) **Field of Search** D3/201; D6/407, D6/408, 626-635, 124; D14/26, 27; D19/32, 33, 74, 89; D27/340, 360; 40/626, 771, 775, 307; 150/149; 132/312; 206/307.1, 308.1, 308.3, 309, 311, 312, 313, 387.13, 396, 408, 232; 229/67.1, 68.1, 70-72

FIG. 1 is a perspective view of a storage container for a disc shaped item of recorded media showing our new design; FIG. 2 is a top plan view of the storage container; FIG. 3 is a front view of FIG. 2; FIG. 4 is a right side elevational view of FIG. 2; FIG. 5 is a left side elevational view of FIG. 2; FIG. 6 is a rear elevational view of FIG. 2; FIG. 7 is a bottom plan view of FIG. 2; FIG. 8 is a top plan view of the first embodiment of the storage container in an open condition; FIG. 9 is a perspective view of a second embodiment of the design shown in FIG. 1; FIG. 10 is a top plan view of the second embodiment of the storage container; FIG. 11 is a front elevational view of FIG. 10; FIG. 12 is a right side elevational view of FIG. 10; FIG. 13 is a left side elevational view of FIG. 10; FIG. 14 is a rear elevational view of FIG. 10; FIG. 15 is a bottom plan view of FIG. 10; and, FIG. 16 is a top plan view of the second embodiment of the invention in an open condition.

(56) **References Cited**

U.S. PATENT DOCUMENTS

D. 229,549	*	12/1973	Mascetti	D6/632
D. 385,145	*	10/1997	VerWeyst et al.	D6/632
D. 386,013	*	11/1997	Tell	D6/407
D. 430,444	*	9/2000	Allsop et al.	D6/632
4,149,729	*	4/1979	Peters	206/309
4,387,807	*	6/1983	Rosa	206/312
4,699,291	*	10/1987	Prais et al.	220/319
5,848,687	*	12/1998	Shultz	206/308.1
6,012,574	*	1/2000	Ennis	206/308.1
6,021,894	*	2/2000	Lakoski et al.	206/308.1

1 Claim, 8 Drawing Sheets

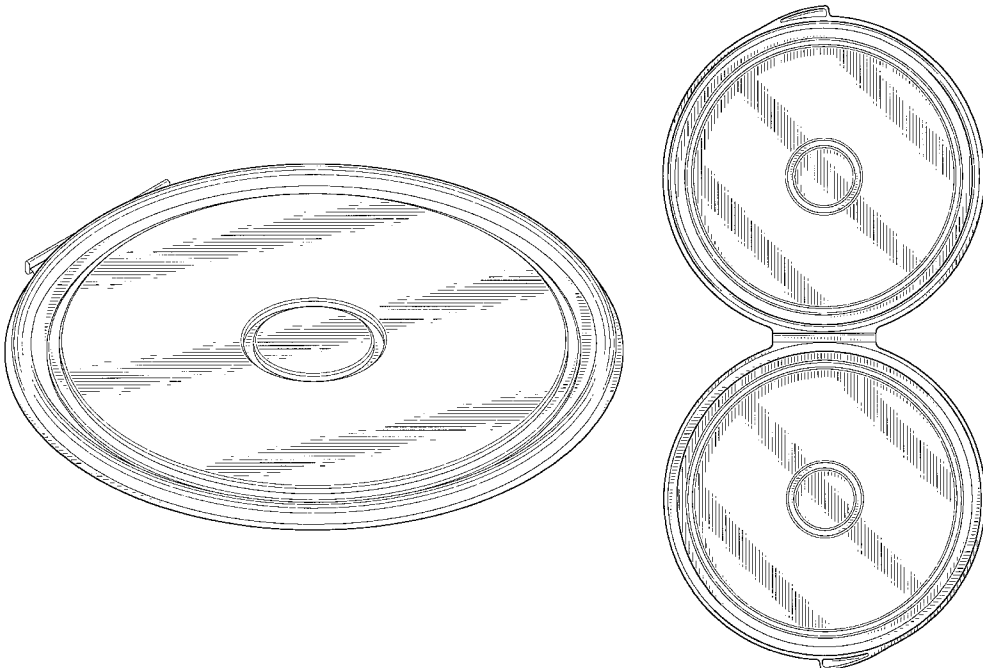

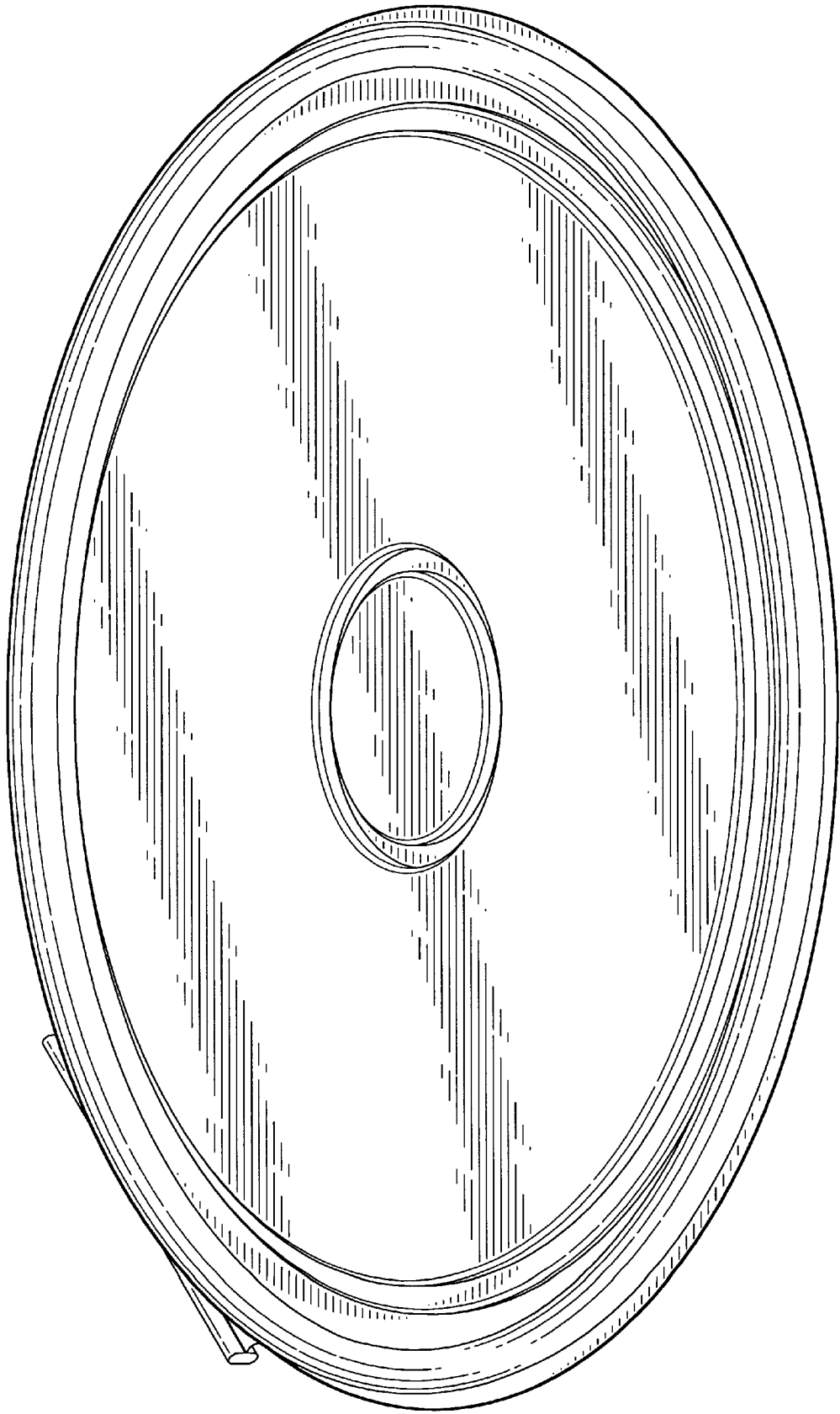

FIG-1

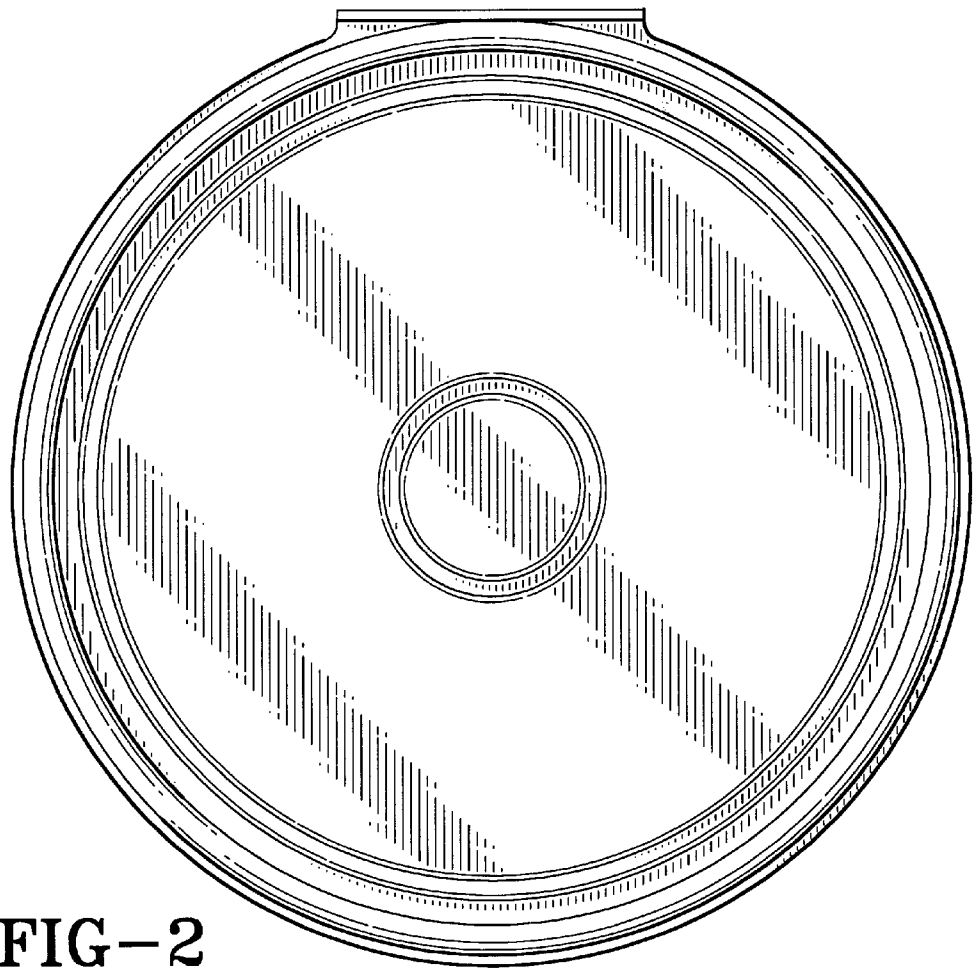

FIG-2

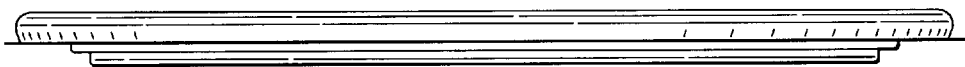

FIG-3

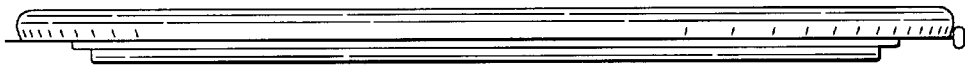

FIG-4



FIG-5



FIG-6

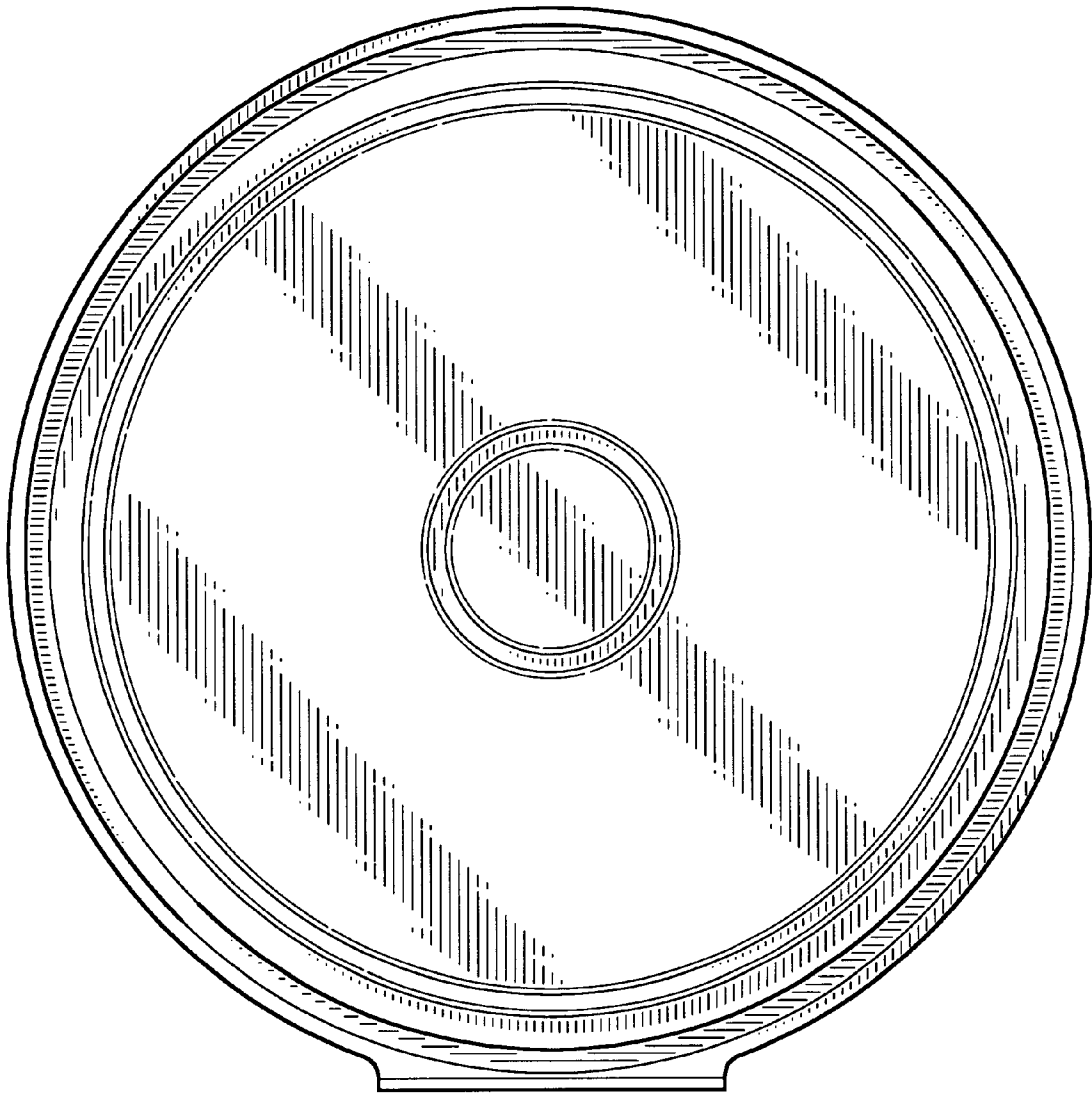

FIG-7

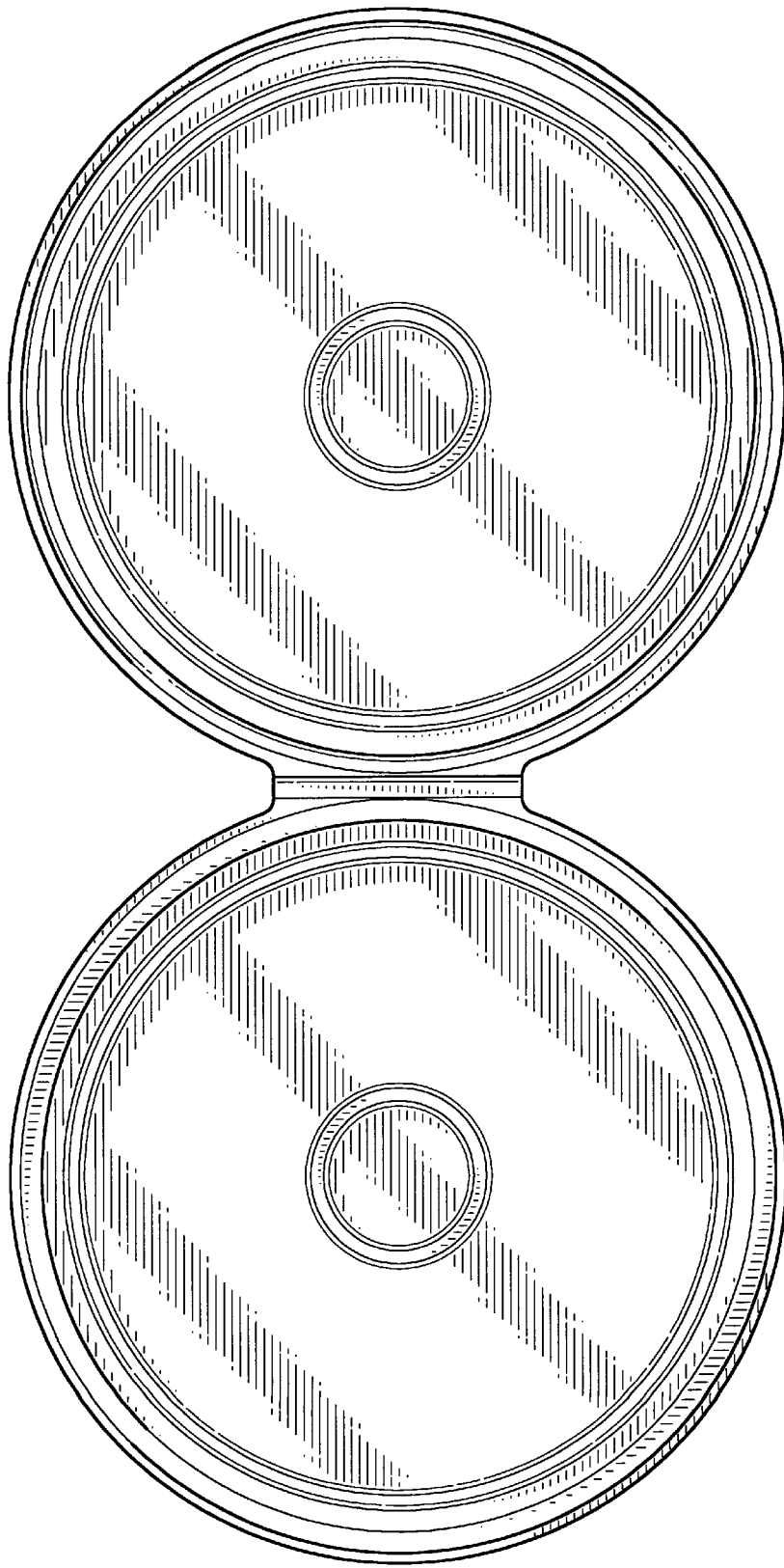

FIG-8

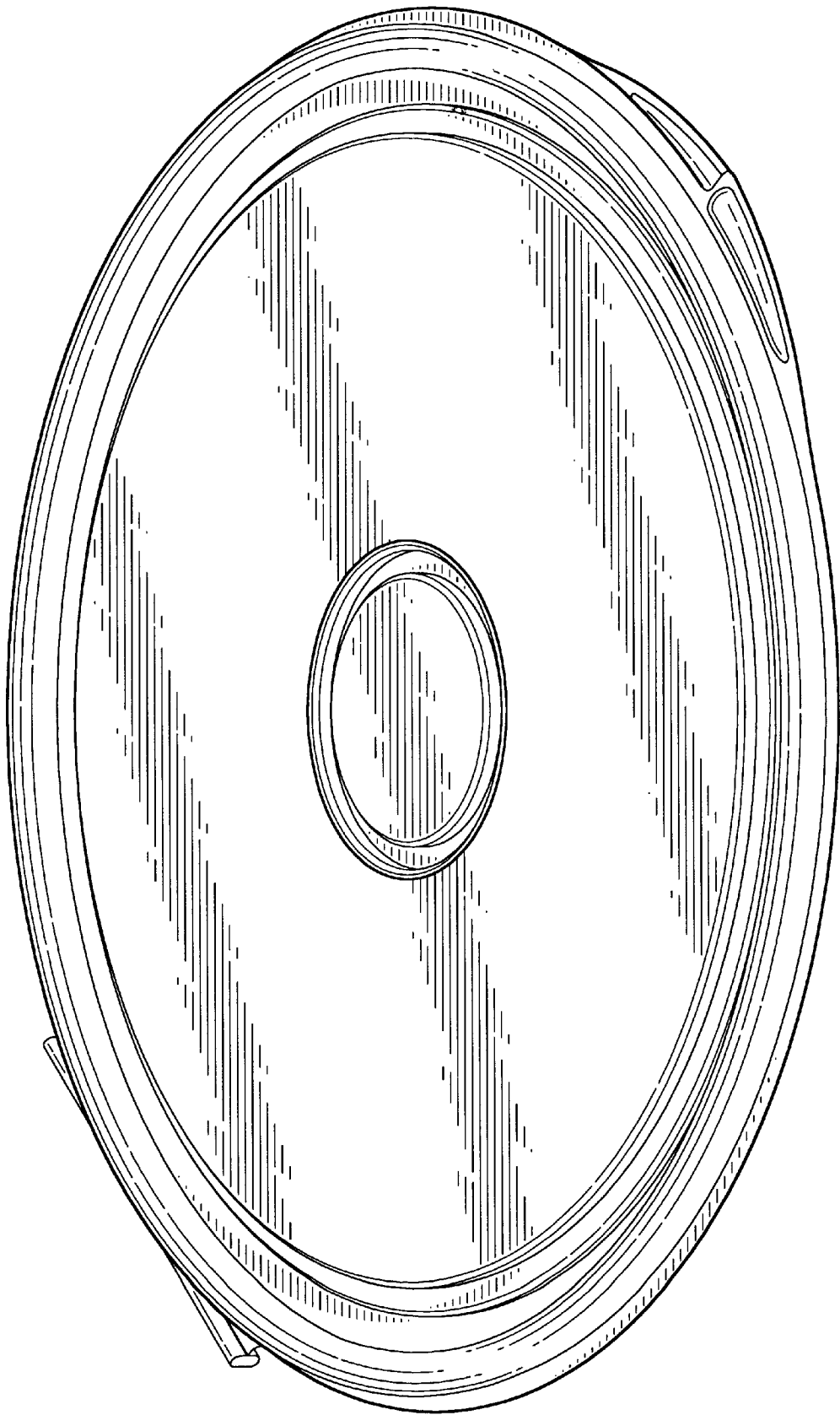

FIG-9

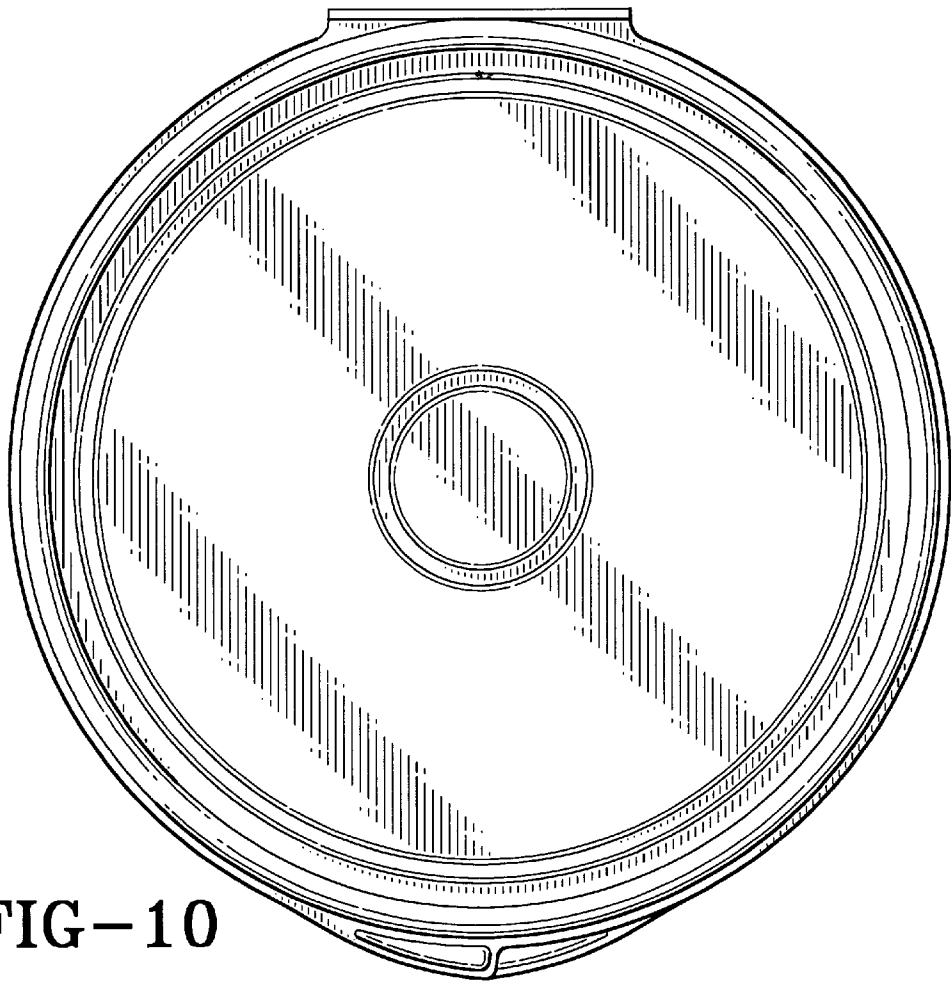

FIG-10

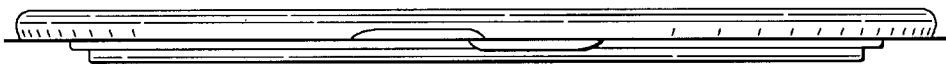

FIG-11



FIG-12

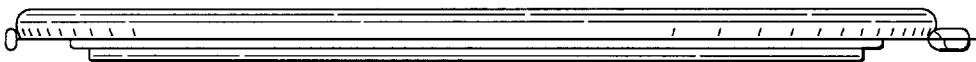

FIG-13

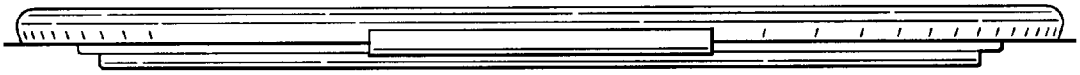

FIG-14

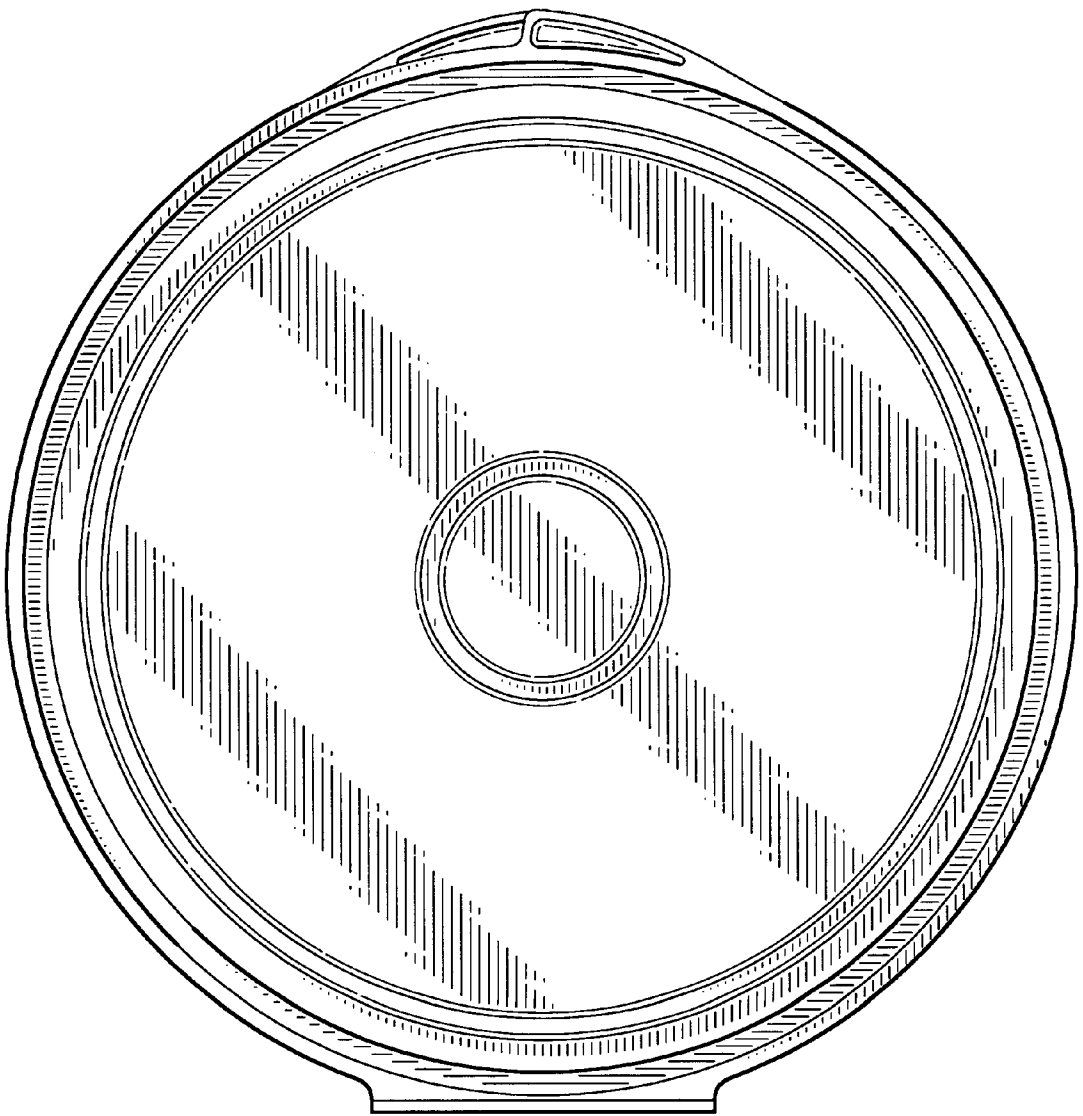

FIG-15

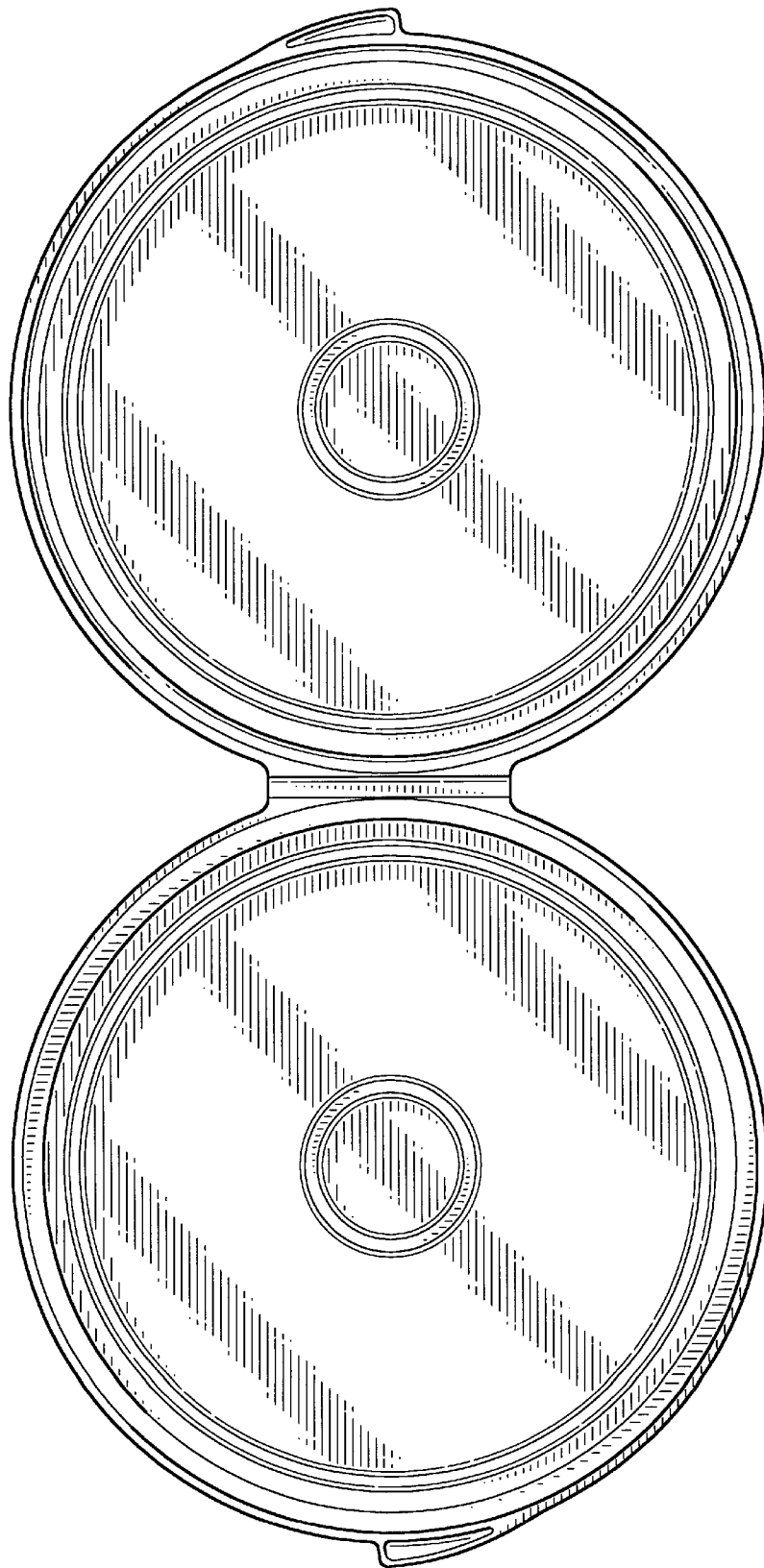

FIG-16