



US00D694357S

(12) **United States Design Patent**
Brodey et al.

(10) **Patent No.:** **US D694,357 S**

(45) **Date of Patent:** **** Nov. 26, 2013**

(54) **SHOWERHEAD**

Primary Examiner — Robin V Webster

(75) Inventors: **Lawrence B. Brodey**, South Orange, NJ (US); **Christopher Pike**, Princeton, NJ (US)

(74) *Attorney, Agent, or Firm* — McCarter & English, LLP

(73) Assignee: **Durst Corporation, Inc.**, Cranford, NJ (US)

(57) **CLAIM**

The ornamental design for a showerhead, as shown and described.

(**) Term: **14 Years**

(21) Appl. No.: **29/415,324**

(22) Filed: **Mar. 9, 2012**

(51) **LOC (9) Cl.** **23-01**

(52) **U.S. Cl.**
USPC **D23/213**

(58) **Field of Classification Search**
USPC D23/213, 229, 230; 239/282, 283
See application file for complete search history.

(56) **References Cited**

U.S. PATENT DOCUMENTS

D87,961 S	8/1932	Ferguson
D328,944 S	8/1992	Robbins
6,042,027 A	3/2000	Sandvik
6,250,572 B1	6/2001	Chen
D461,525 S	8/2002	Lai
D475,433 S	6/2003	Citterio
D487,498 S	3/2004	Blomstrom
D495,778 S	9/2004	Jorgensen et al.
D496,987 S	10/2004	Glunk
D500,121 S	12/2004	Blomstrom
D500,549 S	1/2005	Blomstrom
D500,839 S	1/2005	Blomstrom
D501,242 S	1/2005	Blomstrom

(Continued)

OTHER PUBLICATIONS

“Westbrass Polished Chrome 6” Flat Showerhead D3806-26,” eBay listing, believed to have been posted at least as early as Nov. 18, 2010, at <http://www.ebay.com/itm/Westbrass-Polished-Chrome-6-Flat-Showerhead-D3806-26-/290468831188> (5 pages, including eBay revision summary for listing).

(Continued)

DESCRIPTION

FIG. 1 is a perspective view of a showerhead showing our new design;
 FIGS. 2-7 are a left, right, front, back, top and bottom views thereof;
 FIG. 8 is a perspective view of another embodiment thereof;
 FIGS. 9-14 are a left, right, front, back, top and bottom views thereof;
 FIG. 15 is a perspective view of another embodiment thereof;
 FIGS. 16-21 are a left, right, front, back, top and bottom views thereof;
 FIG. 22 is a perspective of another embodiment thereof;
 FIGS. 22-28 are a left, right, front, back, top and bottom views thereof;
 FIG. 29 is a perspective view of another embodiment thereof;
 FIGS. 30-35 are a left, right, front, back top and bottom views thereof;
 FIG. 36 is a perspective view of another embodiment thereof;
 FIGS. 37-42 are a left, right, front, back, top and bottom views thereof;
 FIG. 43 is a perspective view of another embodiment thereof;
 FIGS. 44-49 are a left, right, front, back, top and bottom views thereof;
 FIG. 50 is a perspective view of another embodiment thereof;
 and,
 FIGS. 51-56 are a left, right, front, back, top and bottom views thereof.
 The broken lines shown herein are for illustrative purposes only, and form no part of the claimed design.

1 Claim, 48 Drawing Sheets

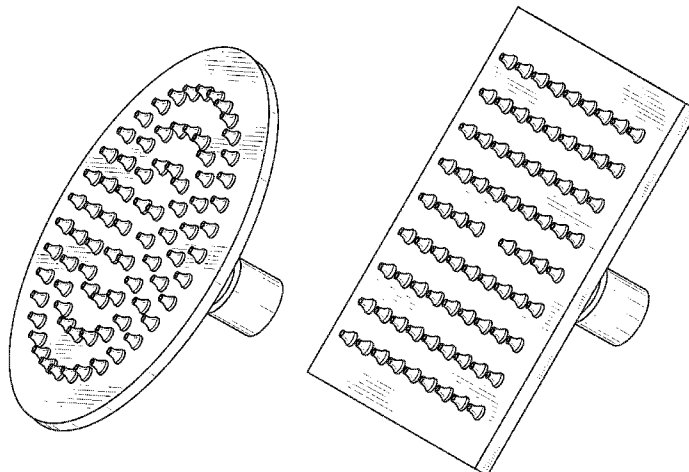

(56)

References Cited

U.S. PATENT DOCUMENTS

D504,936 S * 5/2005 Yeager D23/213
 D512,119 S 11/2005 Haug et al.
 D512,120 S 11/2005 Haug et al.
 D514,197 S 1/2006 Gilbert
 D517,164 S 3/2006 Lee
 D523,520 S 6/2006 Theberge
 D523,925 S 6/2006 Hoernig
 D530,389 S 10/2006 Genslak et al.
 D531,250 S 10/2006 Peterson
 D531,262 S 10/2006 Tse
 D532,076 S 11/2006 Mazzola
 D538,391 S 3/2007 Mazzola
 D540,427 S 4/2007 Bouroullec et al.
 D546,413 S 7/2007 Sedwick
 D552,713 S 10/2007 Rexach
 D556,855 S 12/2007 Mullenmeister et al.
 D557,763 S 12/2007 Schoenherr et al.
 D558,301 S 12/2007 Hoernig
 D559,952 S * 1/2008 Bickler et al. D23/229
 D562,937 S 2/2008 Schoenherr et al.
 D564,071 S 3/2008 Tsai
 D566,228 S 4/2008 Neagoe
 D578,180 S 10/2008 Sieger
 D587,339 S 2/2009 Schoenherr et al.
 D590,046 S 4/2009 Starck
 D593,640 S 6/2009 Schoenherr et al.
 D598,520 S 8/2009 Flowers et al.
 D607,970 S * 1/2010 Schoenherr et al. D23/213
 D612,010 S * 3/2010 Schoenherr et al. D23/213
 D613,370 S 4/2010 Allard et al.

7,721,979 B2 5/2010 Mazzola
 D624,155 S * 9/2010 Yokoyama et al. D23/213
 D626,622 S 11/2010 Gessi
 D626,623 S 11/2010 Gessi
 D627,429 S 11/2010 Gessi
 D627,866 S 11/2010 Hanna
 D634,401 S 3/2011 Flowers et al.
 D637,266 S 5/2011 Flowers et al.
 D639,382 S 6/2011 Flowers
 D639,384 S 6/2011 Flowers et al.
 D639,385 S 6/2011 Flowers et al.
 D641,829 S 7/2011 Angelov et al.
 D643,509 S 8/2011 O'Brien et al.
 D649,623 S 11/2011 Flowers
 D651,281 S * 12/2011 Lobermeier et al. D23/213
 8,109,451 B2 2/2012 Mazzola
 D658,269 S 4/2012 Schoenherr et al.
 D658,270 S 4/2012 O'Brien et al.
 D662,178 S 6/2012 Flowers et al.
 8,240,583 B2 8/2012 Cristina
 D669,963 S 10/2012 O'Brien et al.
 D674,465 S 1/2013 Flowers et al.
 D674,466 S 1/2013 Flowers et al.
 D678,469 S 3/2013 Zhadanov
 D681,781 S 5/2013 Cutler et al.
 2005/0284967 A1 12/2005 Korb et al.
 2007/0200013 A1 8/2007 Hsiao
 2010/0314472 A1 12/2010 Lee

OTHER PUBLICATIONS

Jaclo, The Rain Machine, Dec. 2011 (2 pages).

* cited by examiner

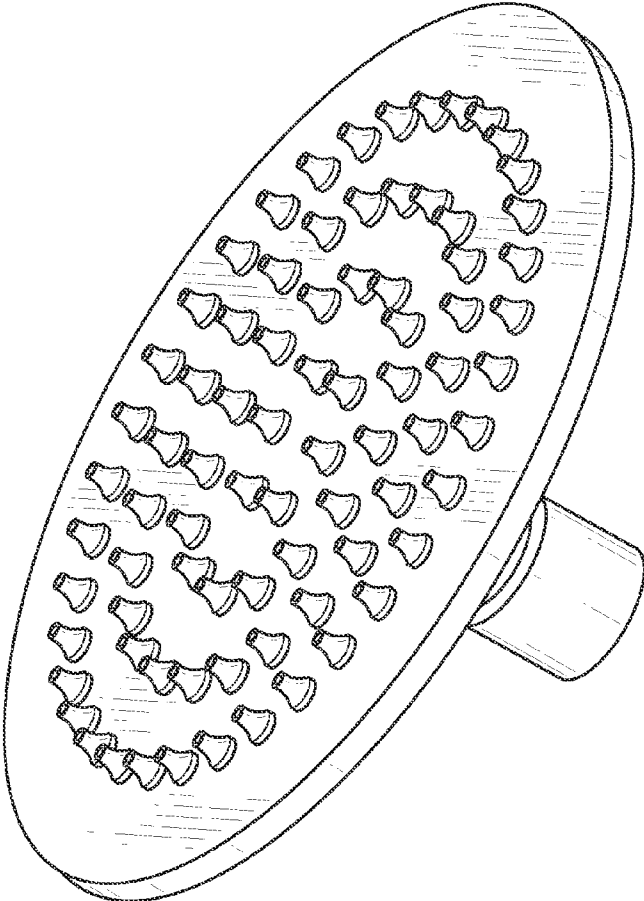

FIG. 1

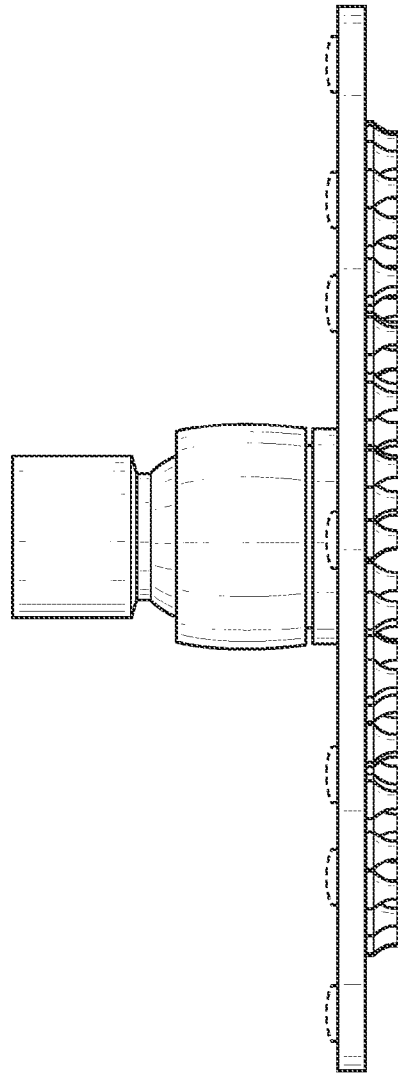

FIG. 2

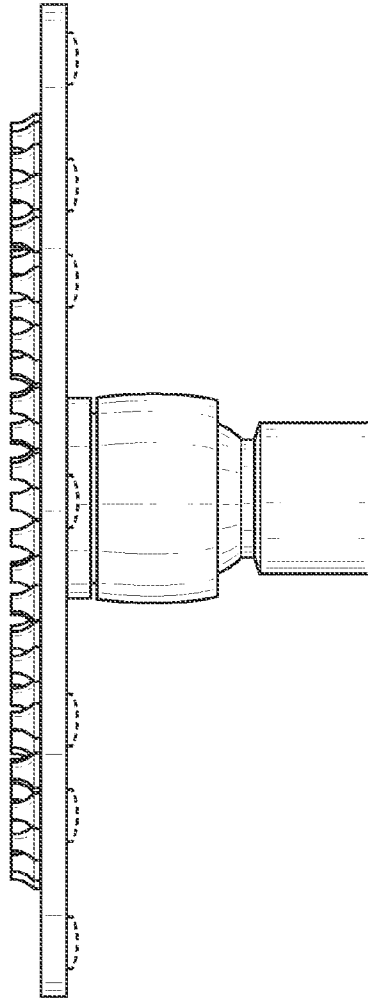

FIG. 3

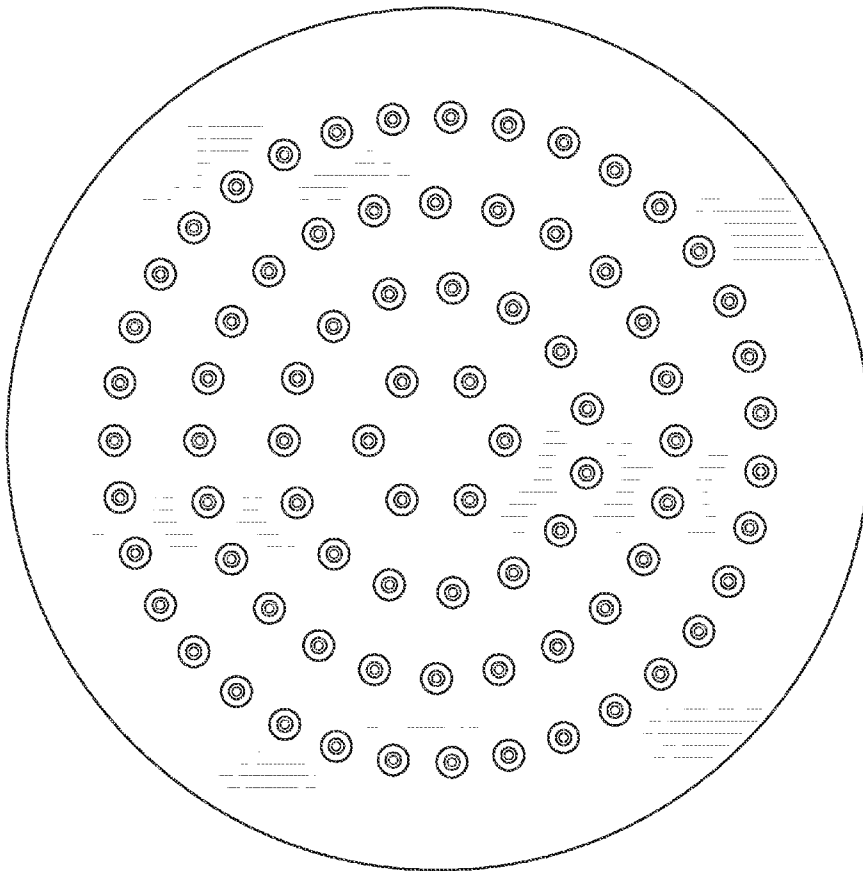

FIG. 4

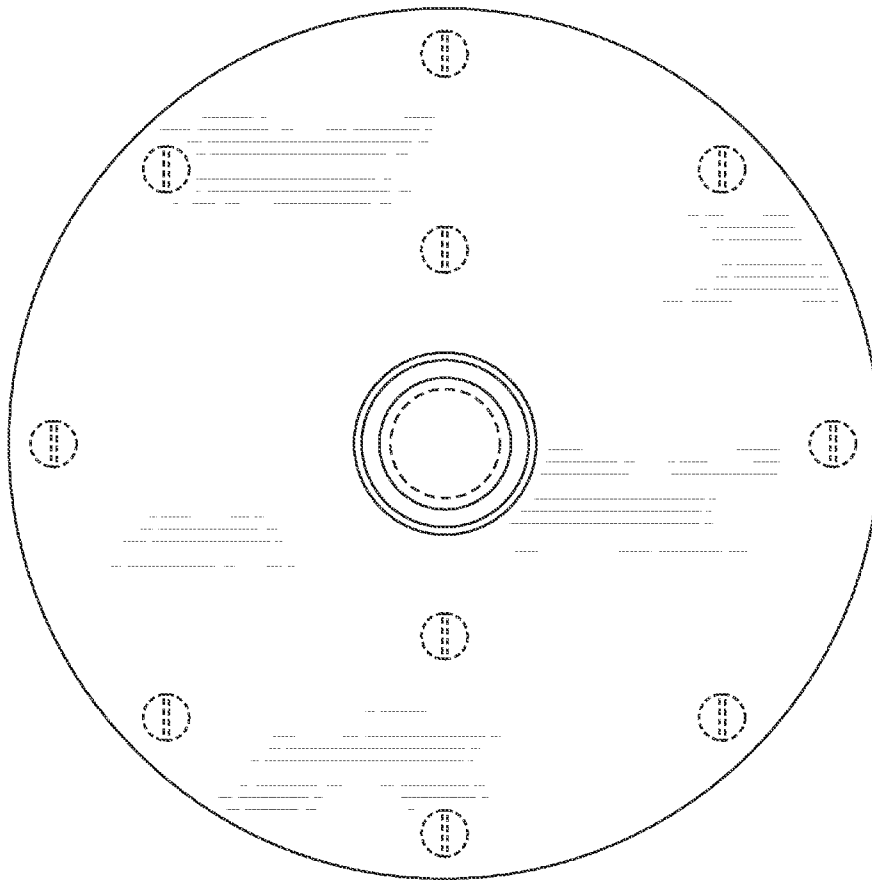

FIG. 5

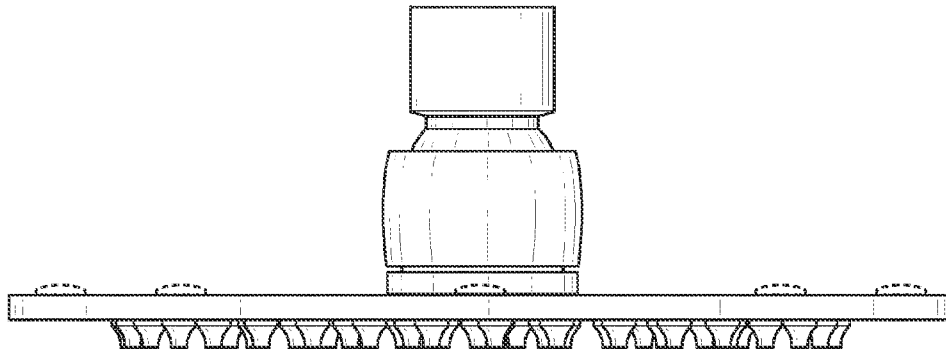

FIG. 6

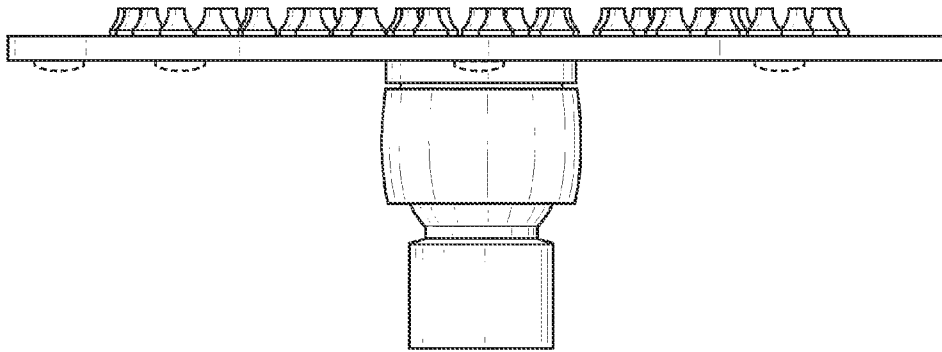

FIG. 7

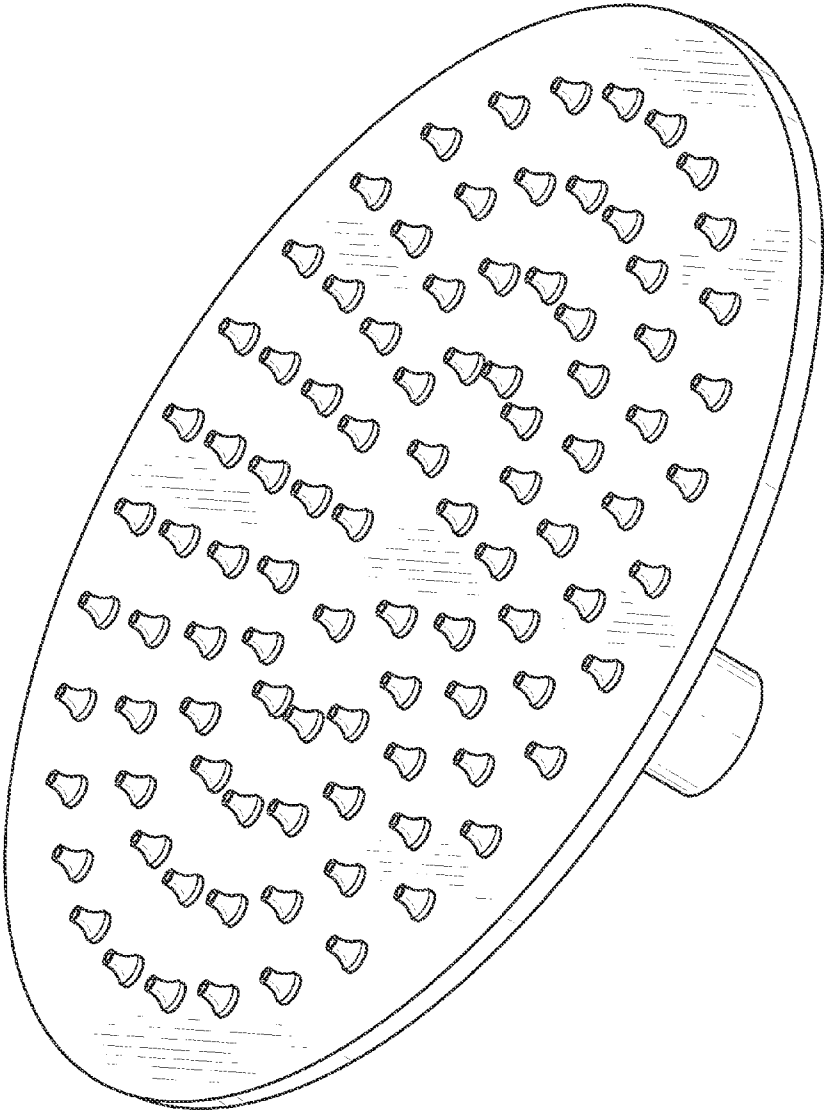

FIG. 8

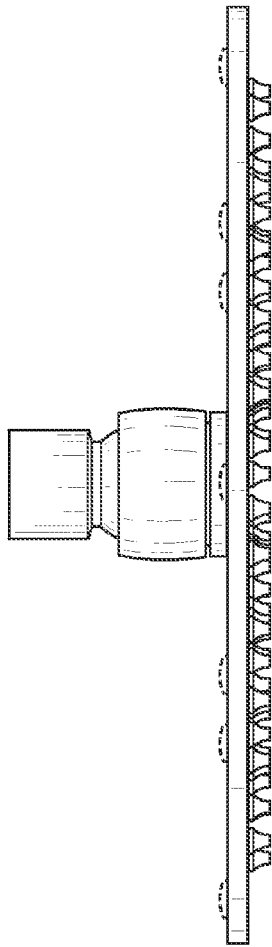

FIG. 9

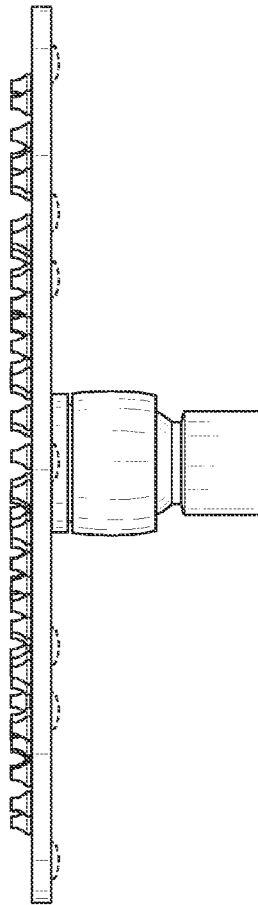

FIG. 10

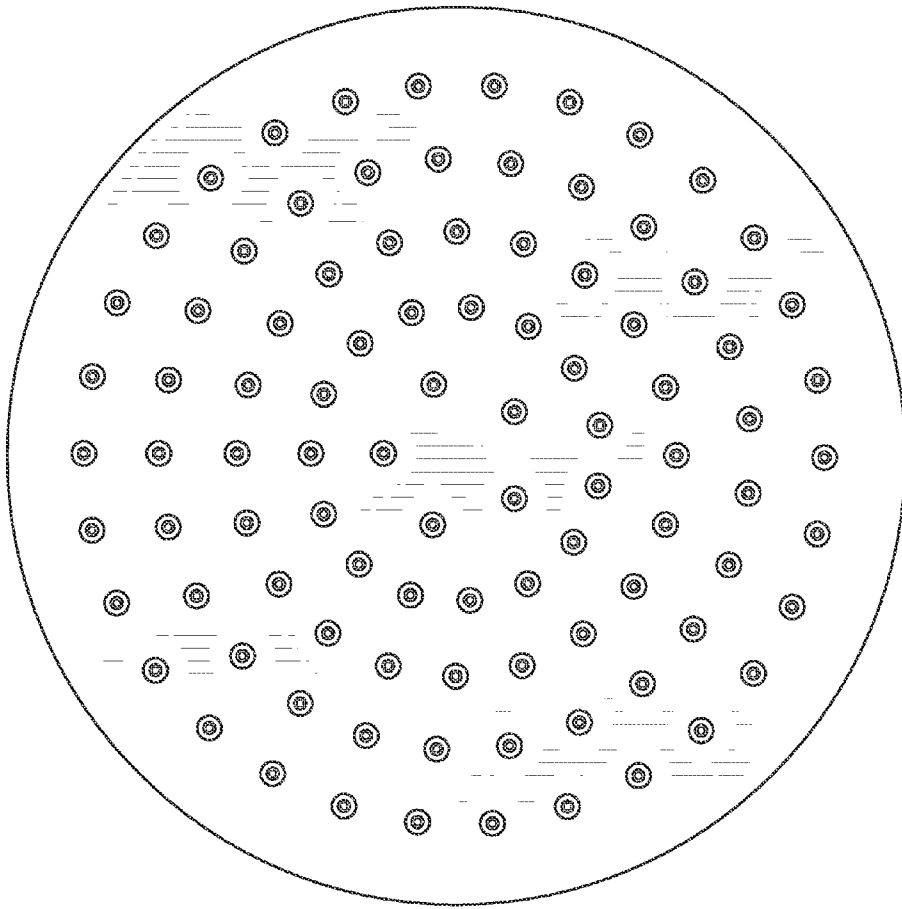

FIG. 11

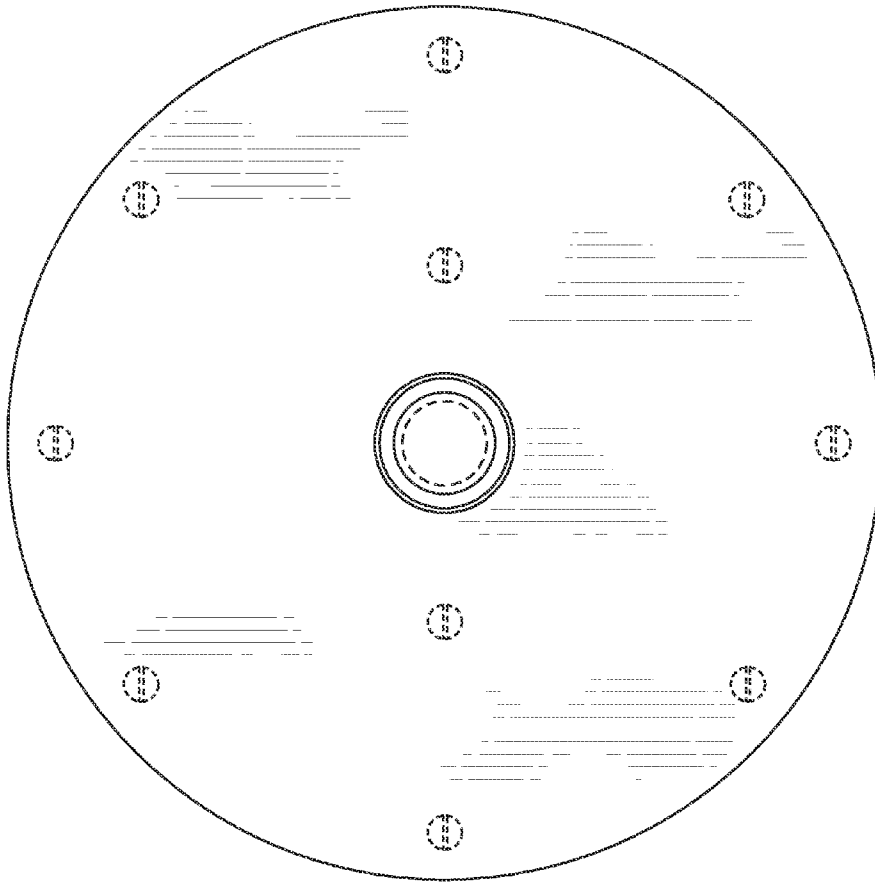

FIG. 12

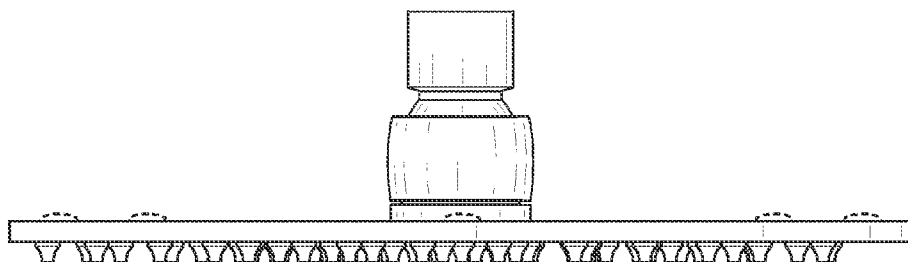

FIG. 13

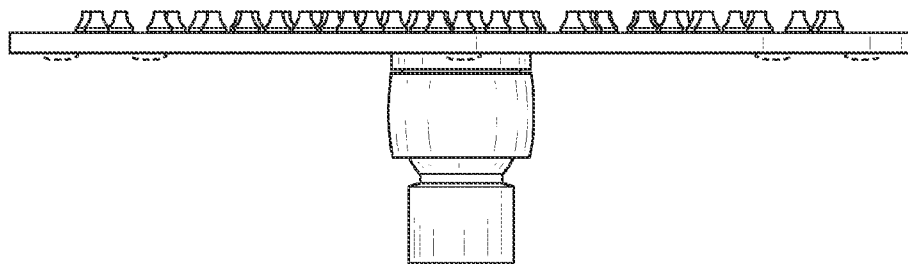

FIG. 14

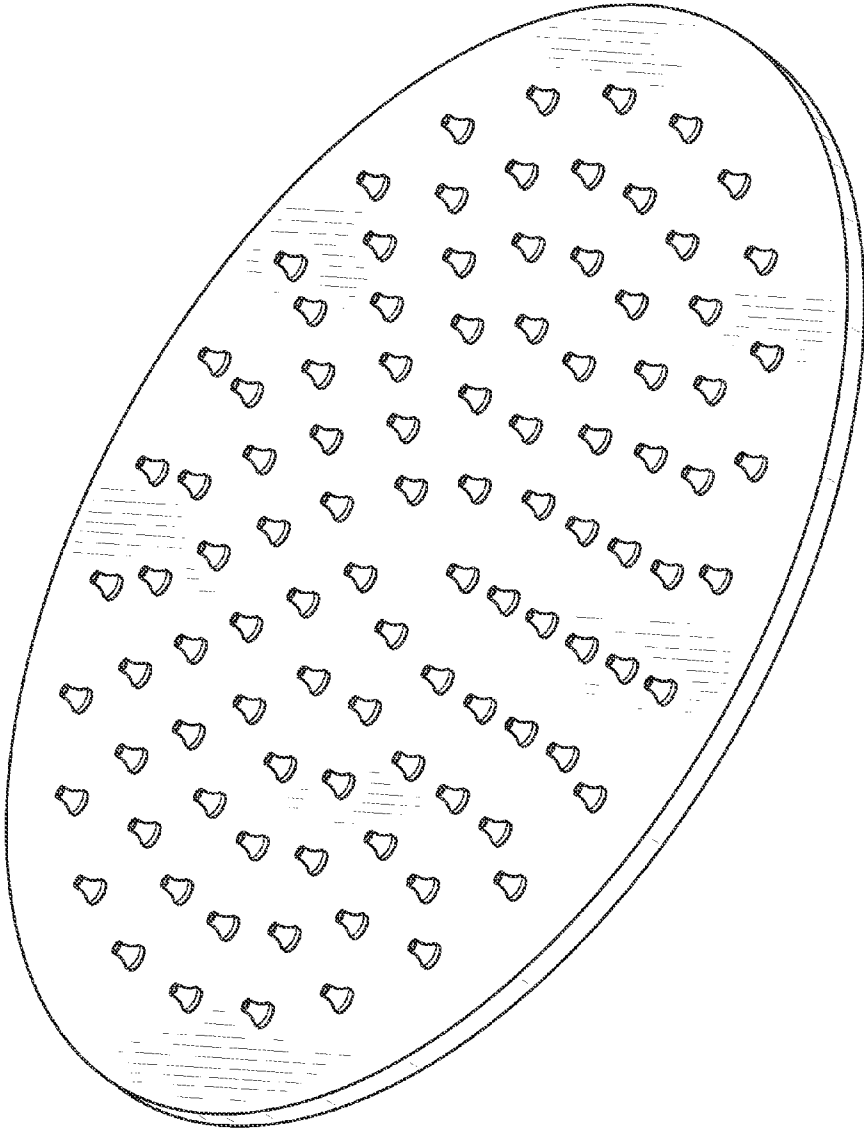

FIG. 15

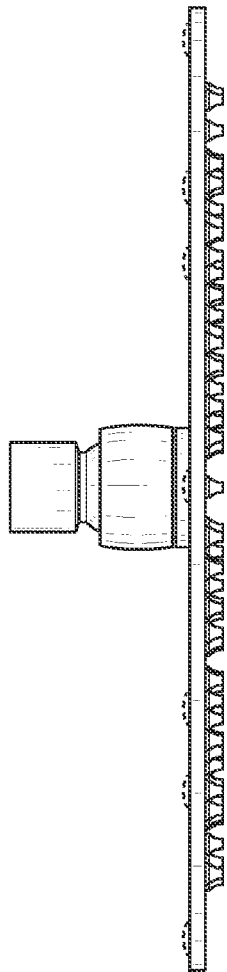

FIG. 16

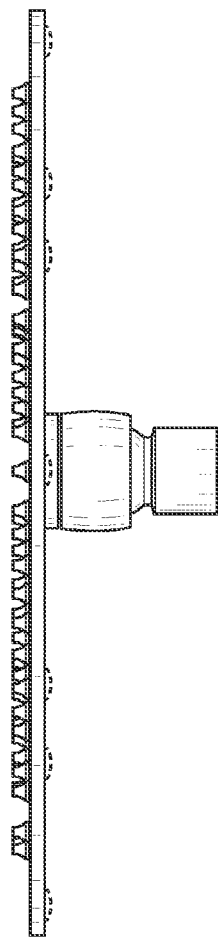

FIG. 17

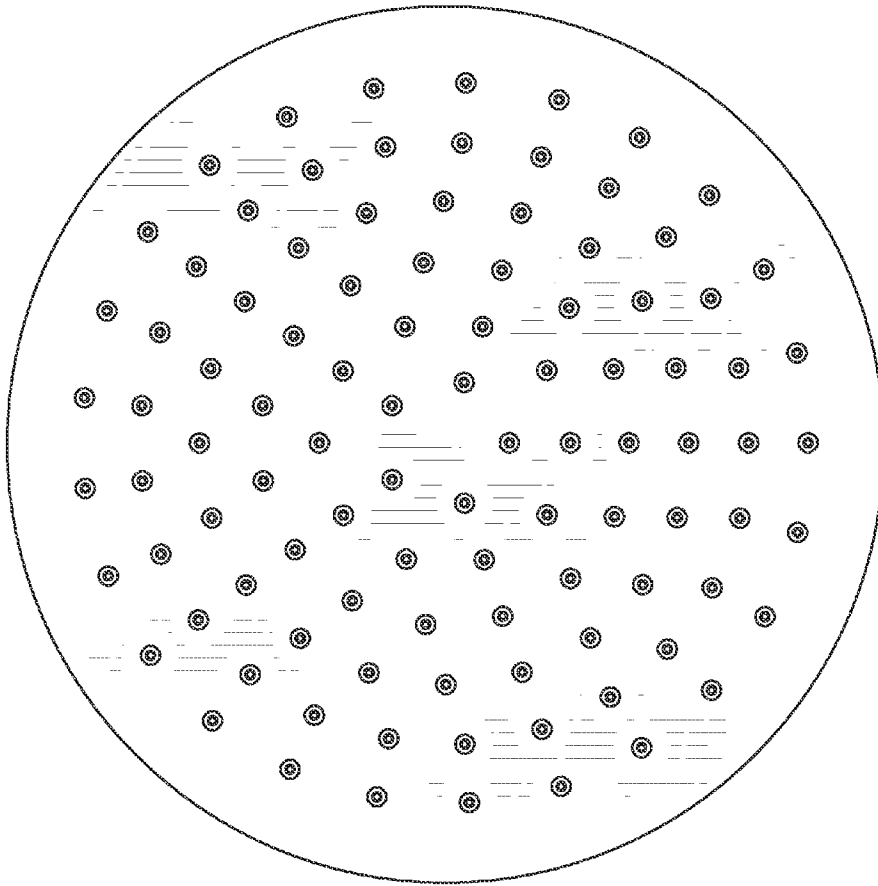

FIG. 18

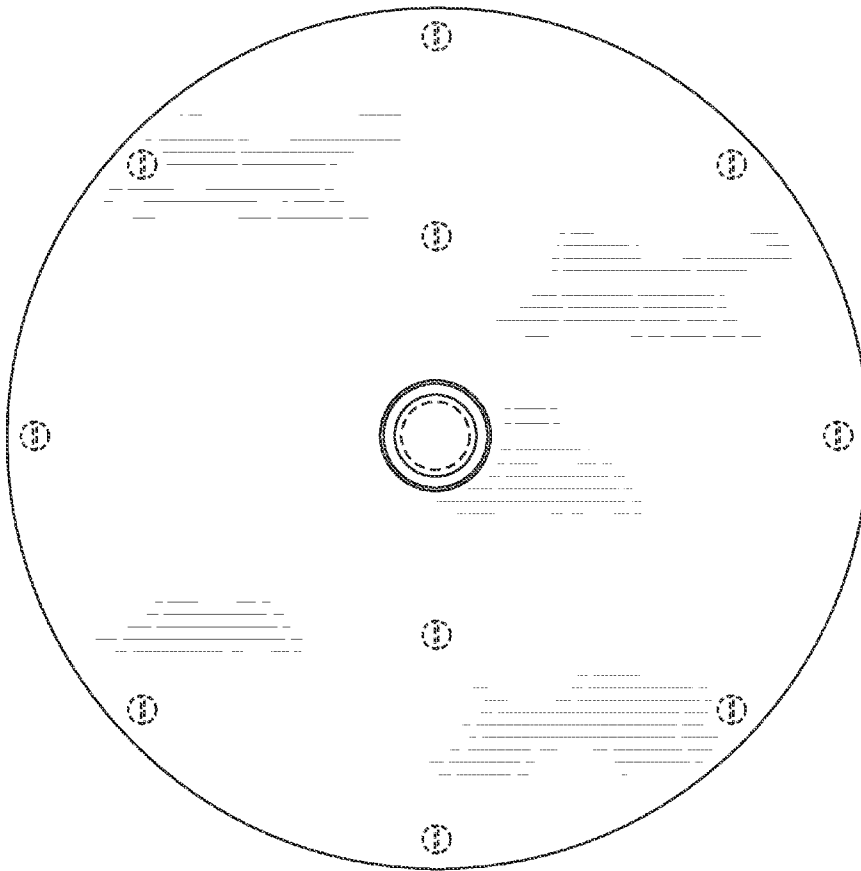

FIG. 19

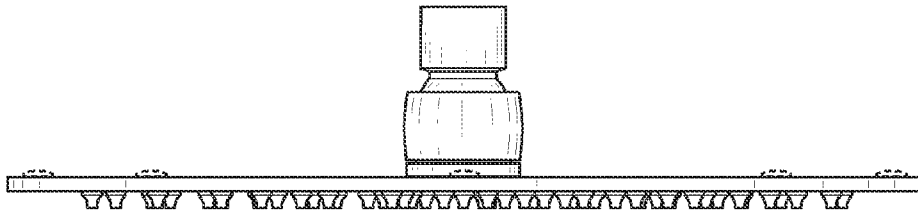

FIG. 20

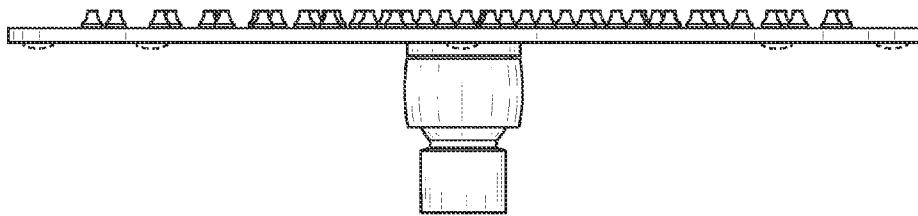

FIG. 21

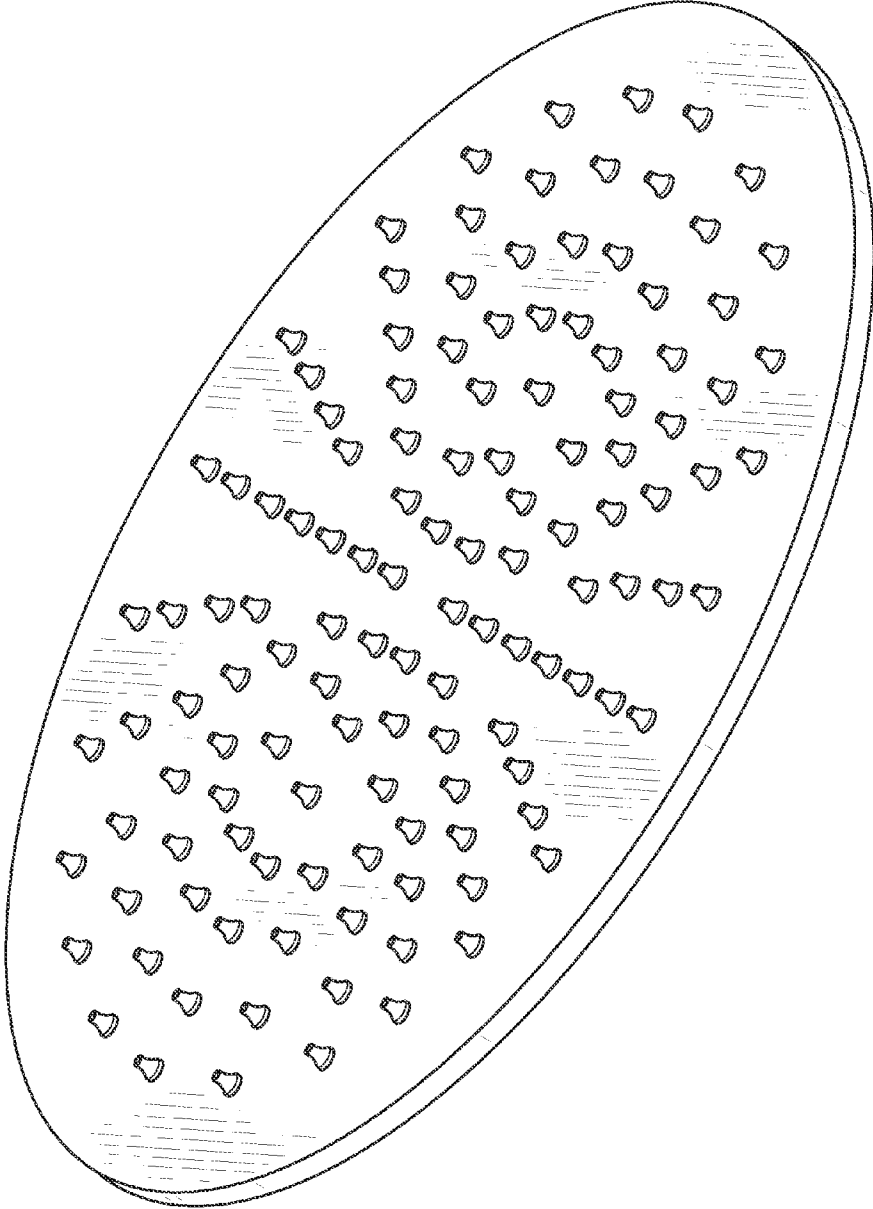

FIG. 22

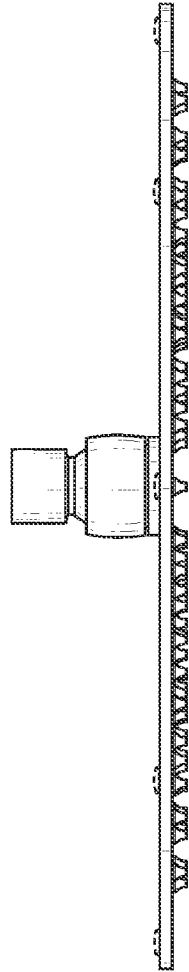

FIG. 23

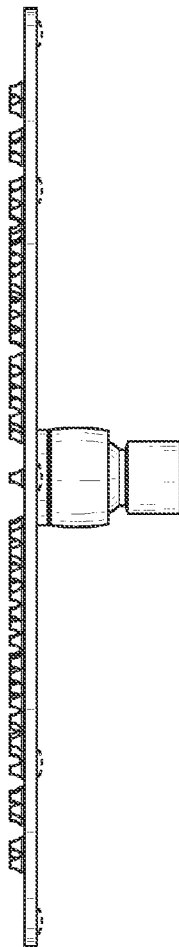

FIG. 24

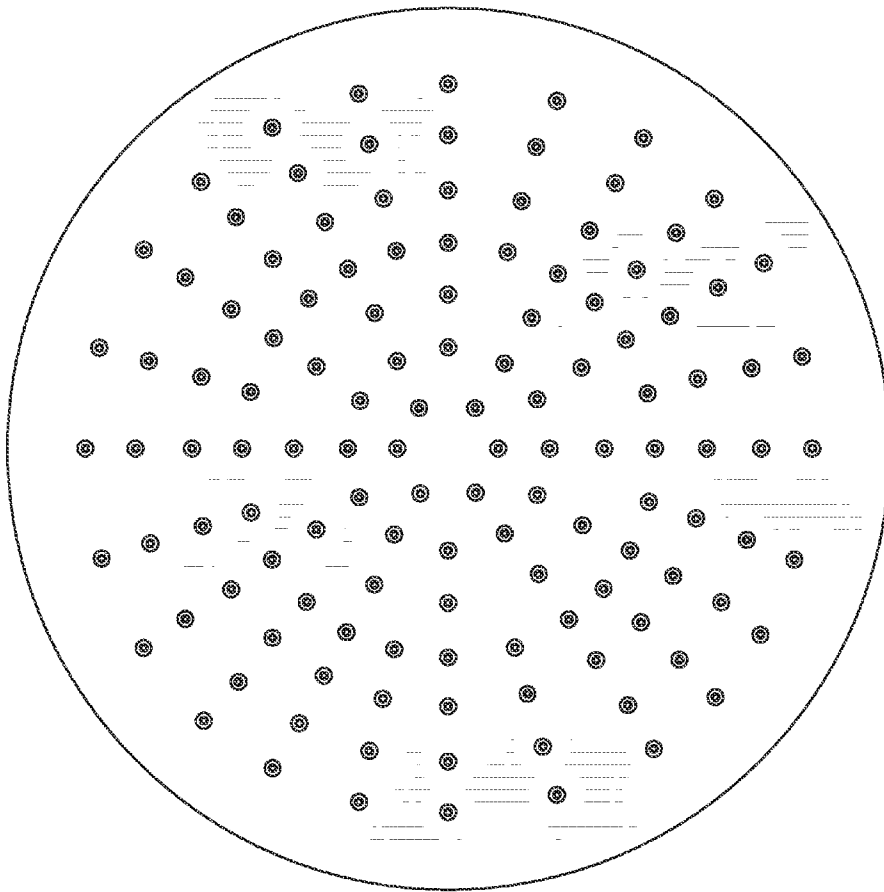

FIG. 25

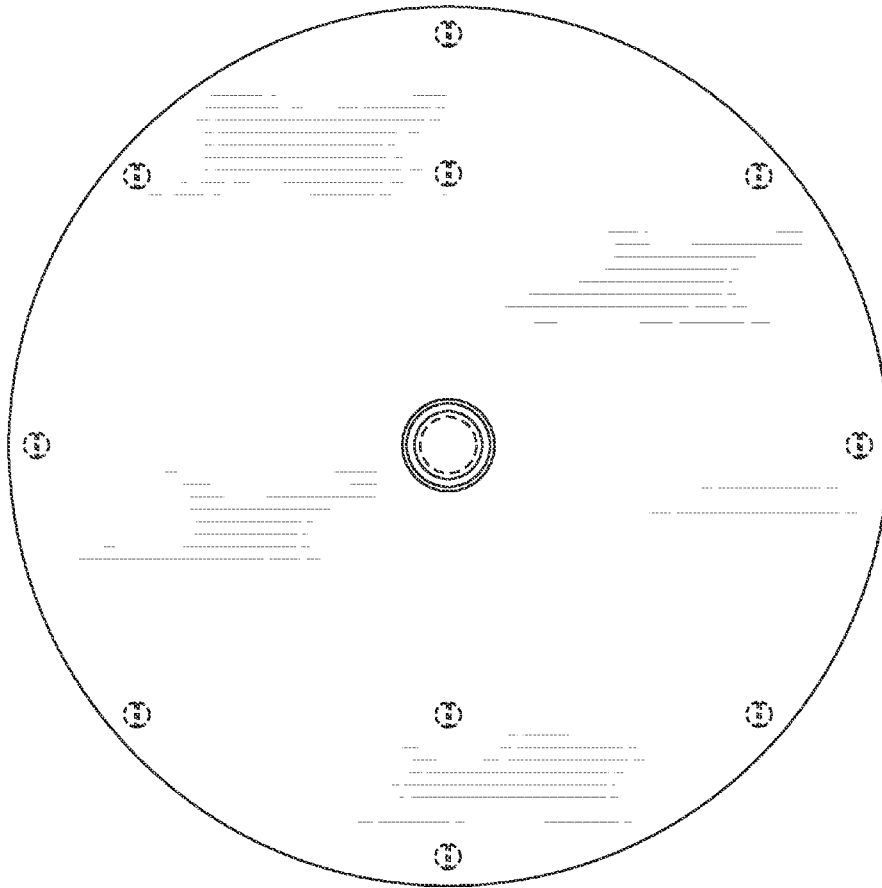

FIG. 26

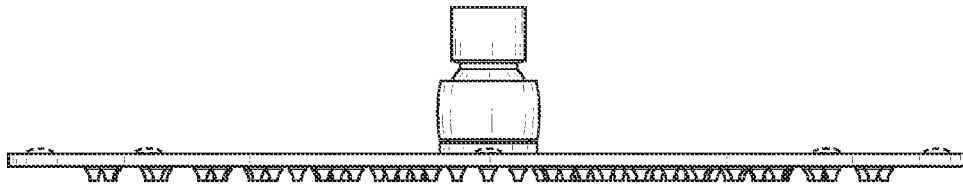

FIG. 27

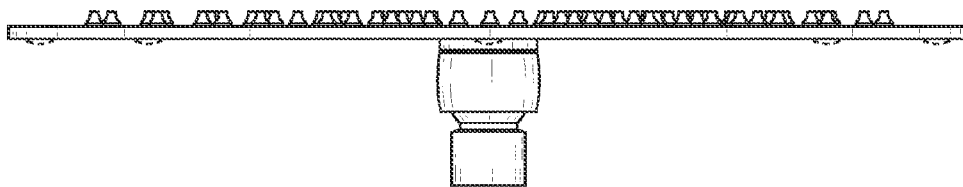

FIG. 28

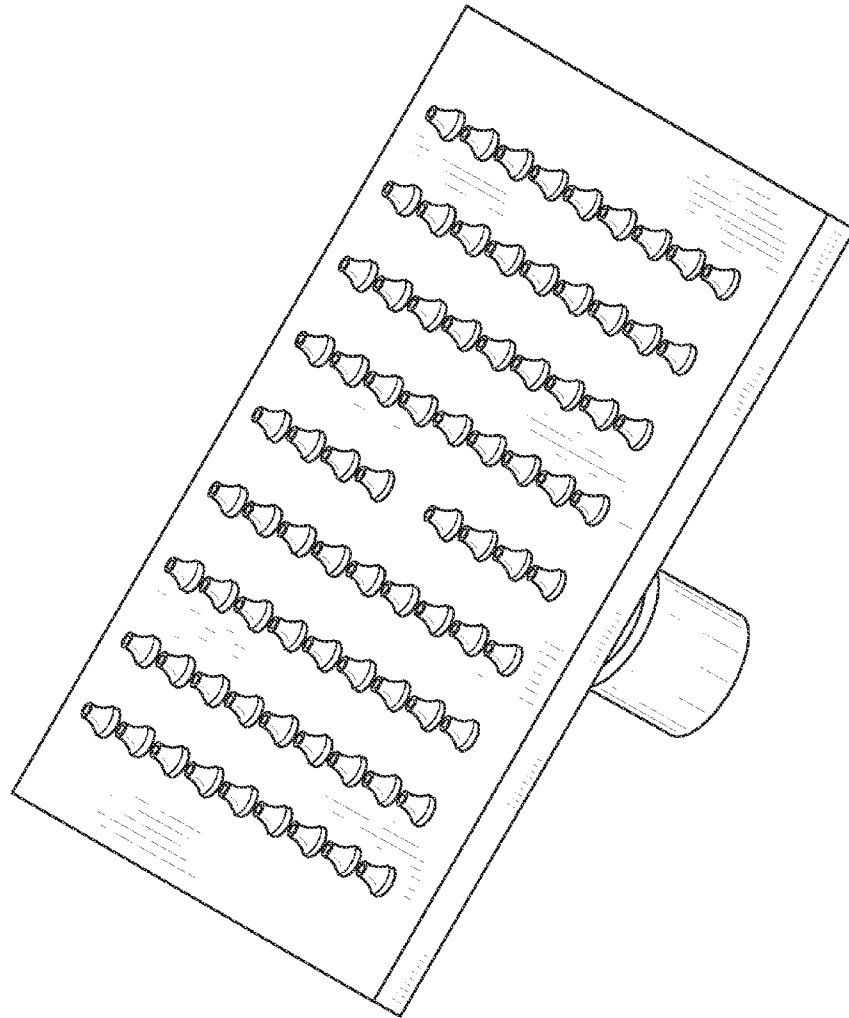

FIG. 29

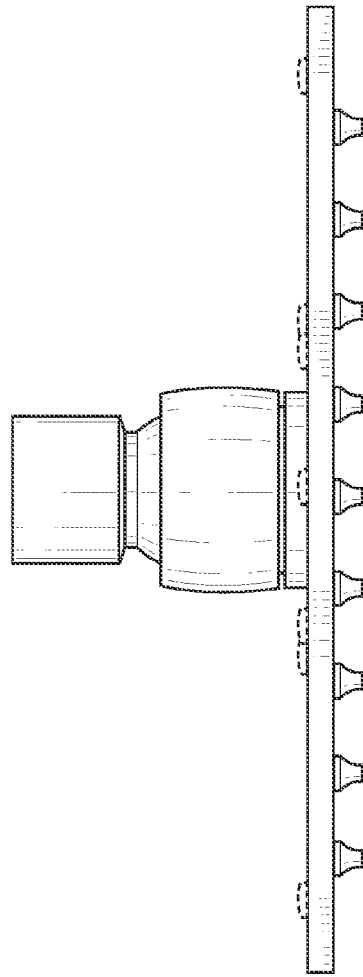

FIG. 30

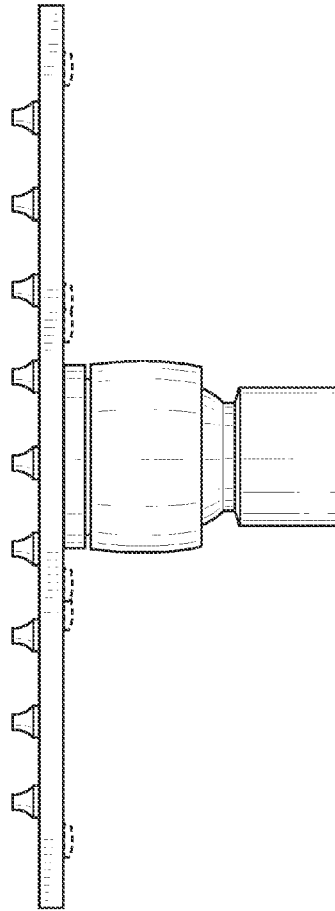

FIG. 31

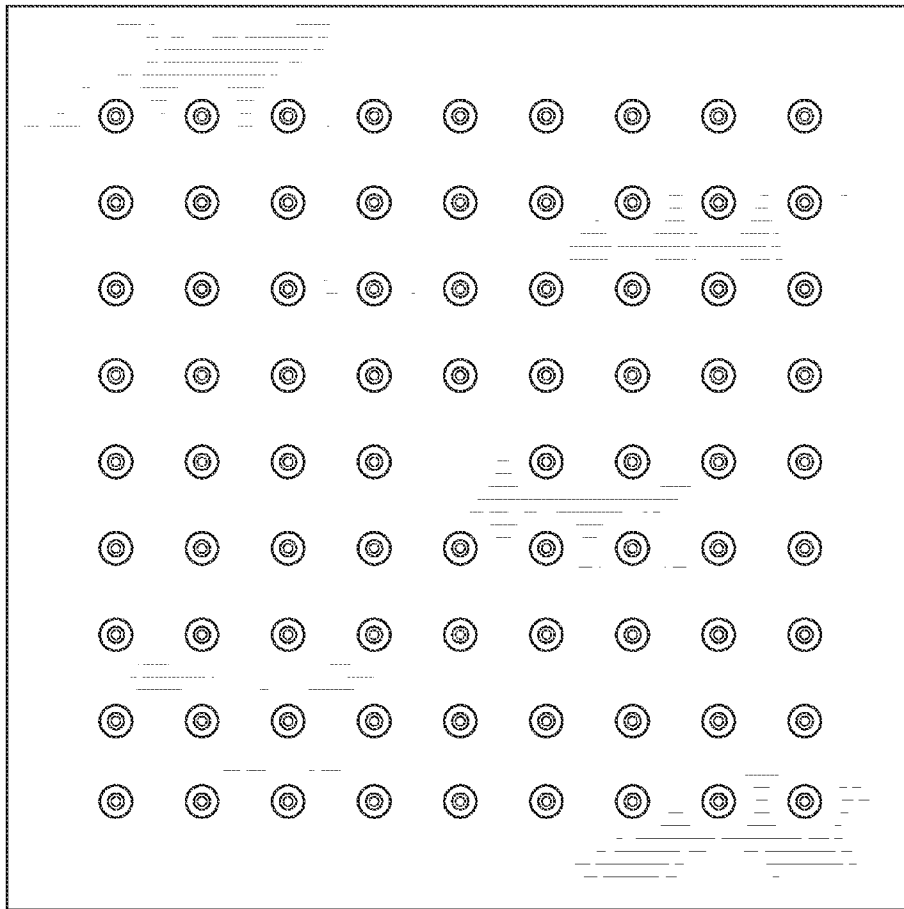

FIG. 32

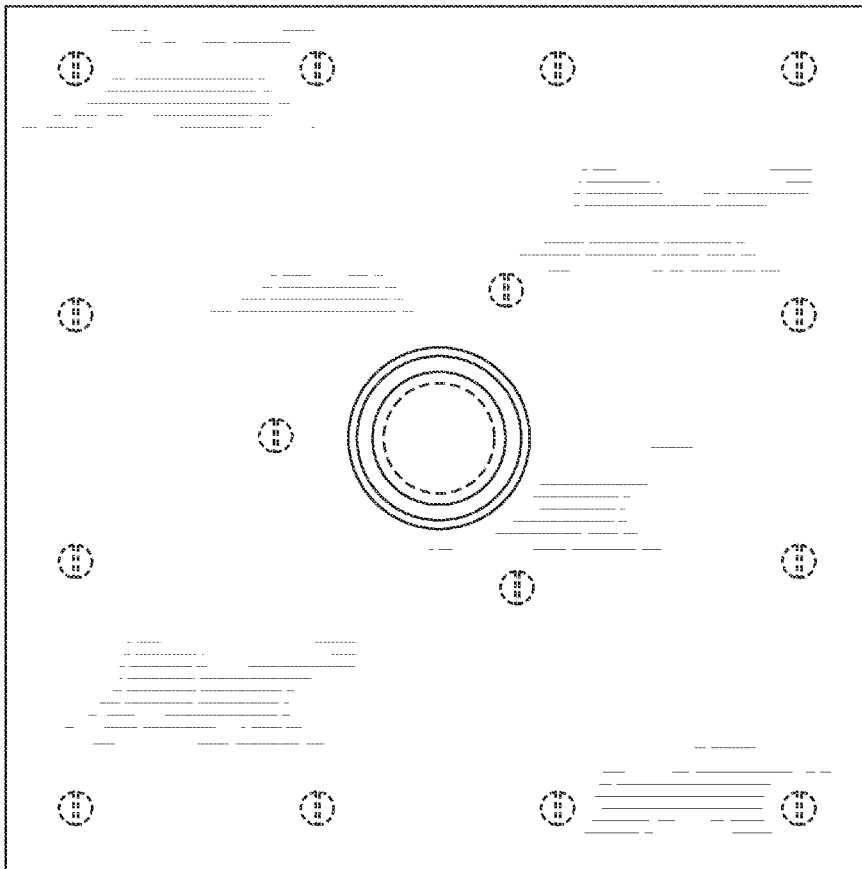

FIG. 33

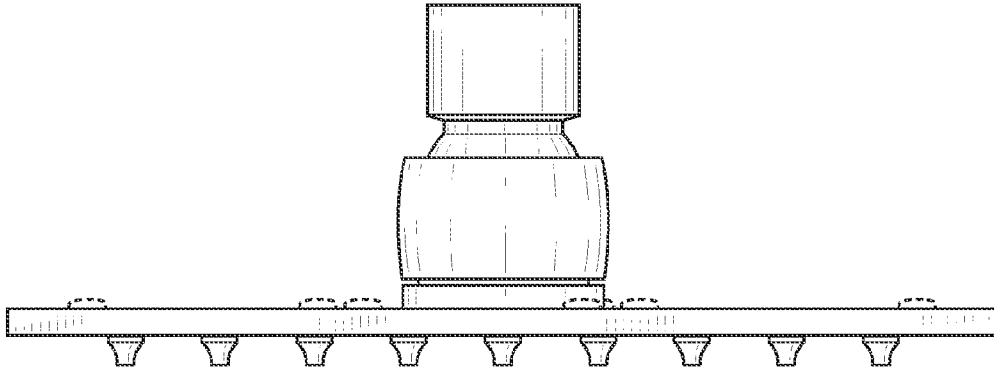

FIG. 34

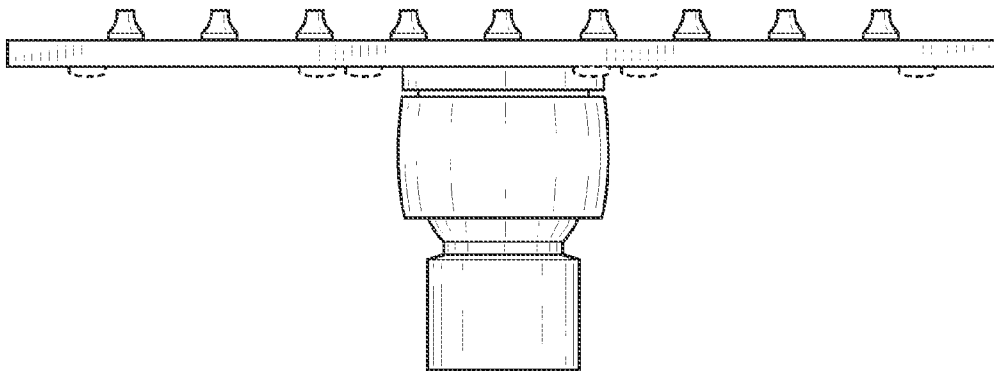

FIG. 35

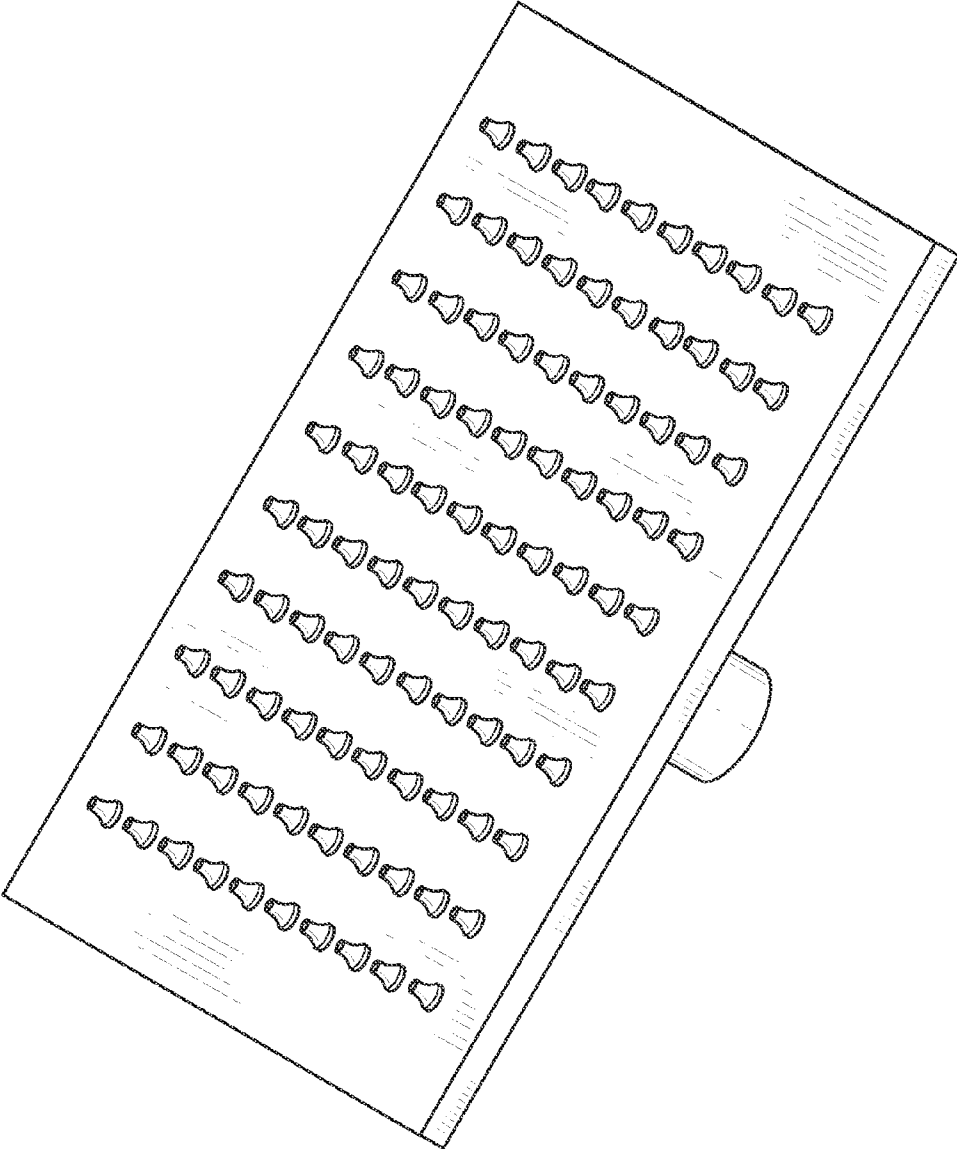

FIG. 36

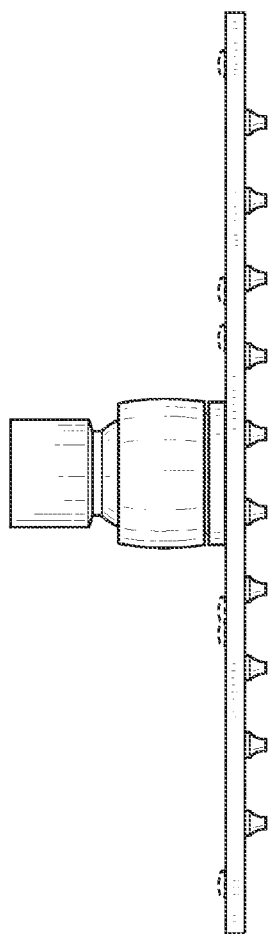

FIG. 37

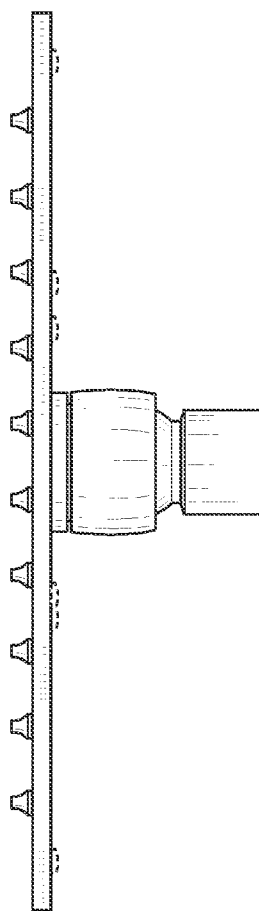

FIG. 38

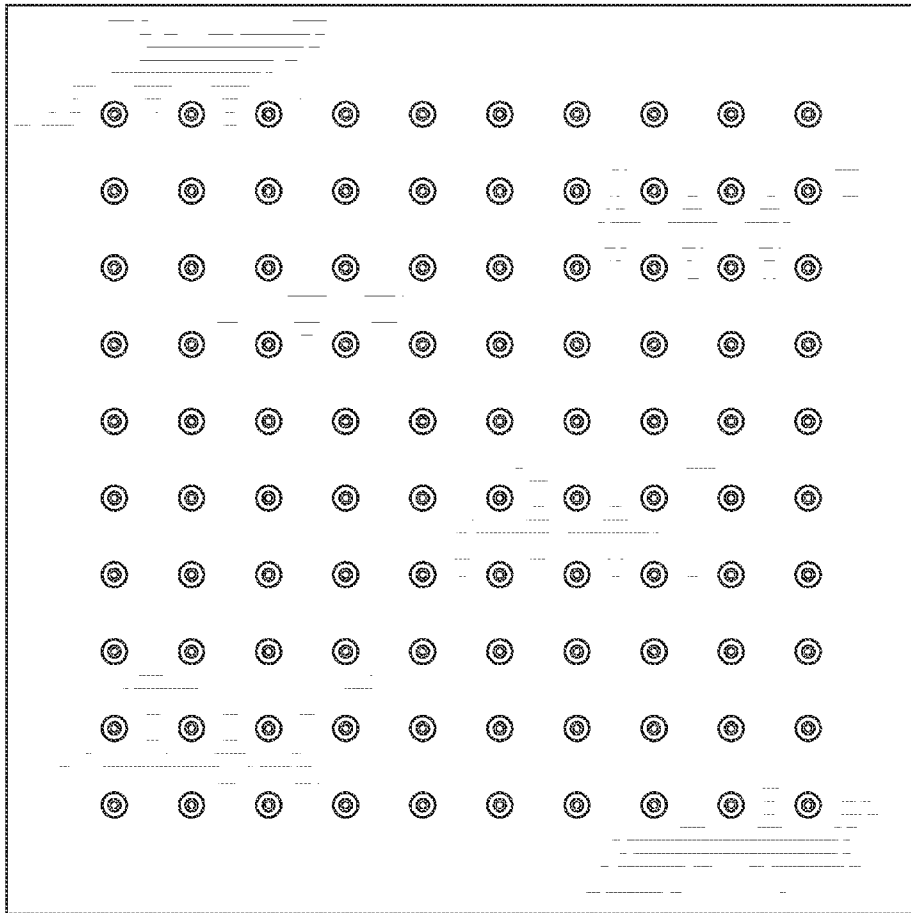

FIG. 39

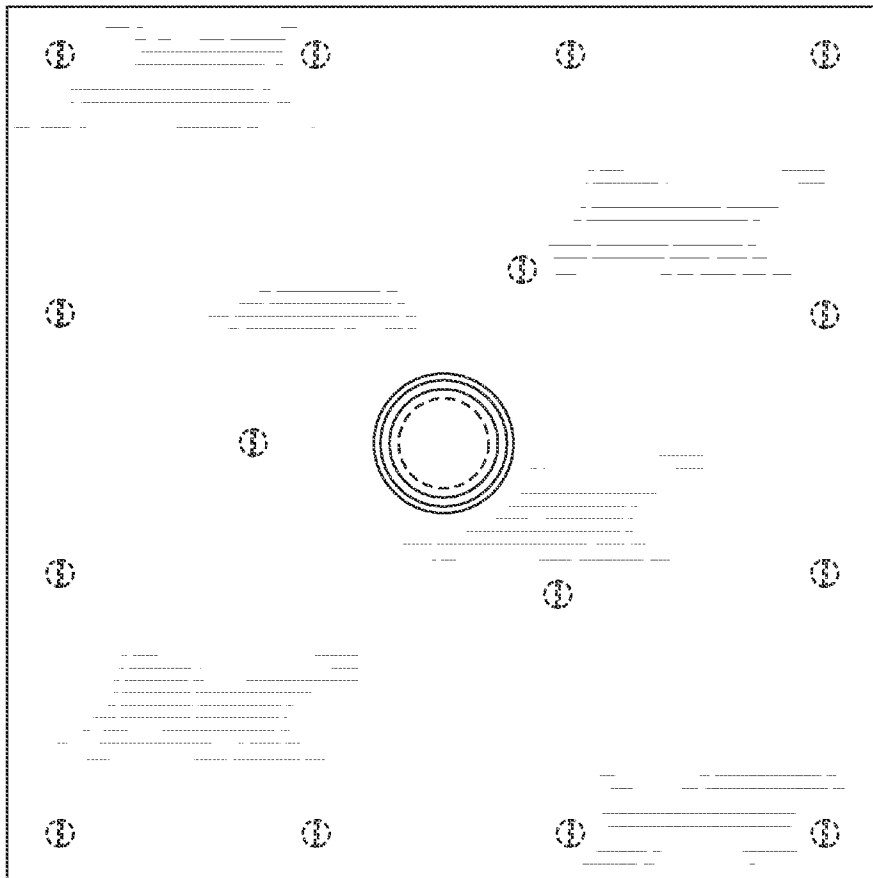

FIG. 40

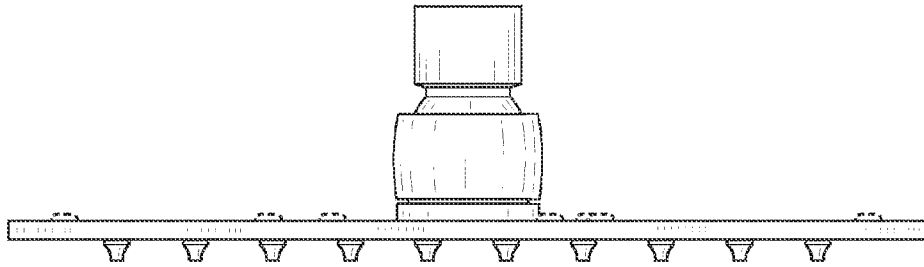

FIG. 41

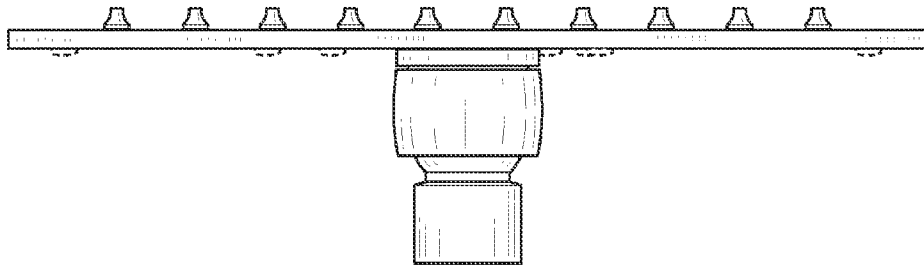

FIG. 42

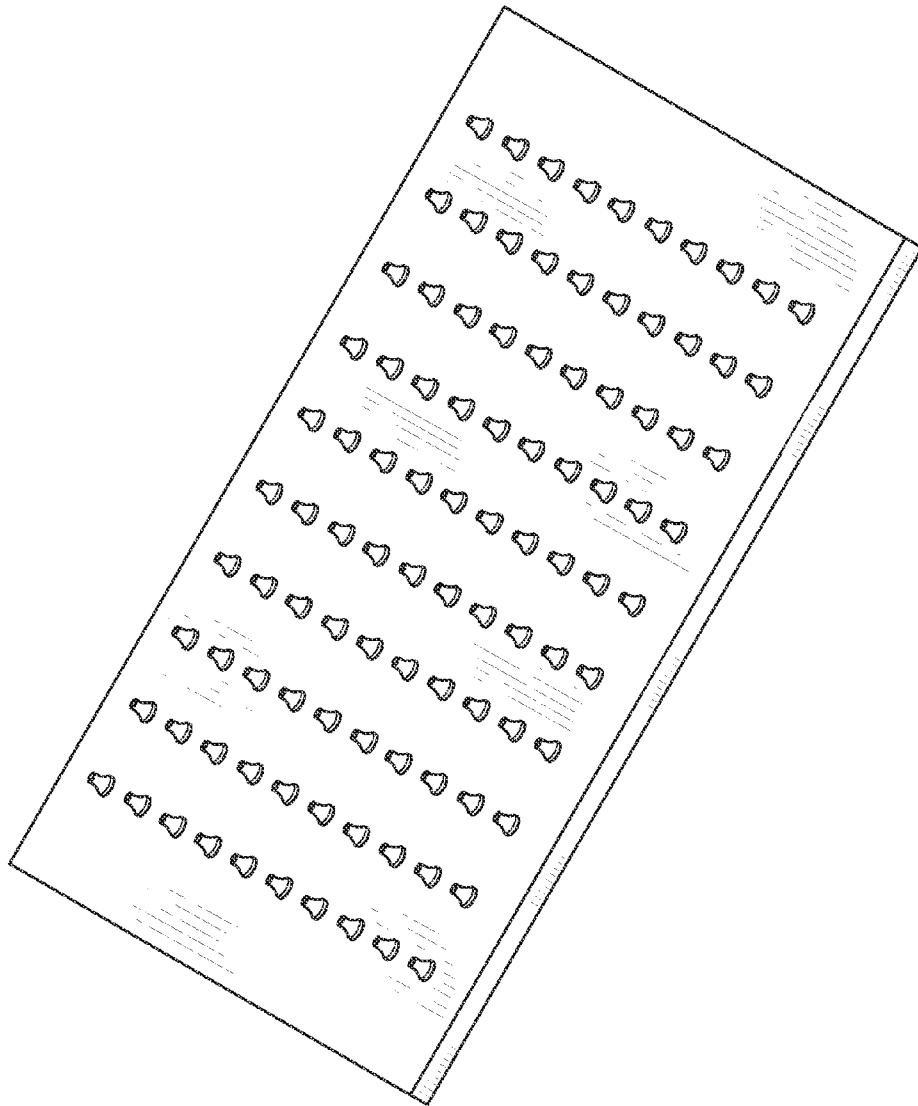

FIG. 43

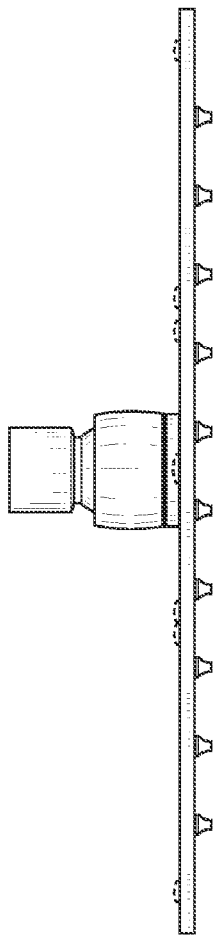

FIG. 44

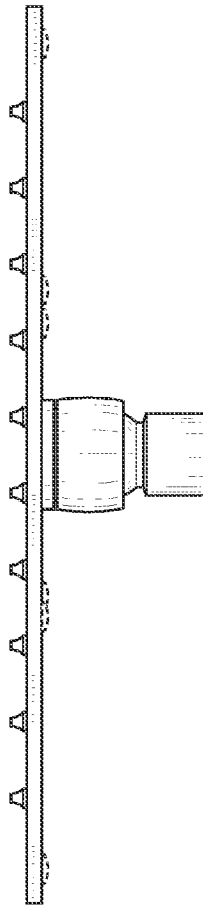

FIG. 45

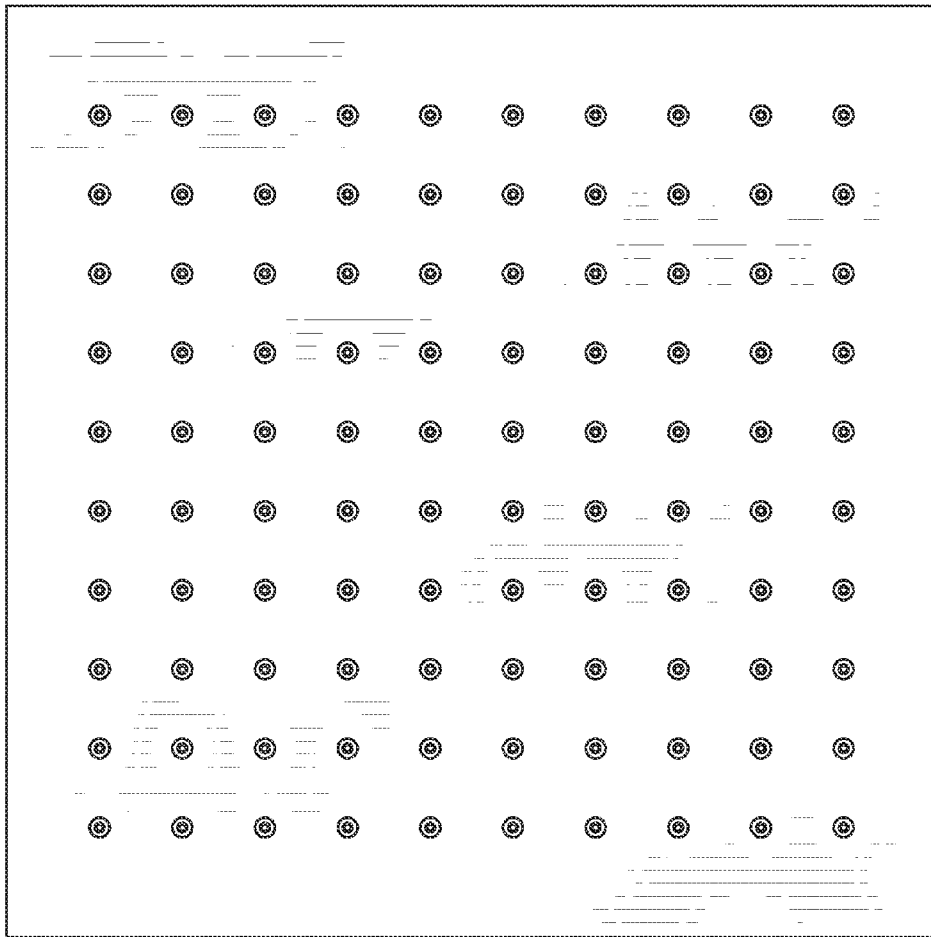

FIG. 46

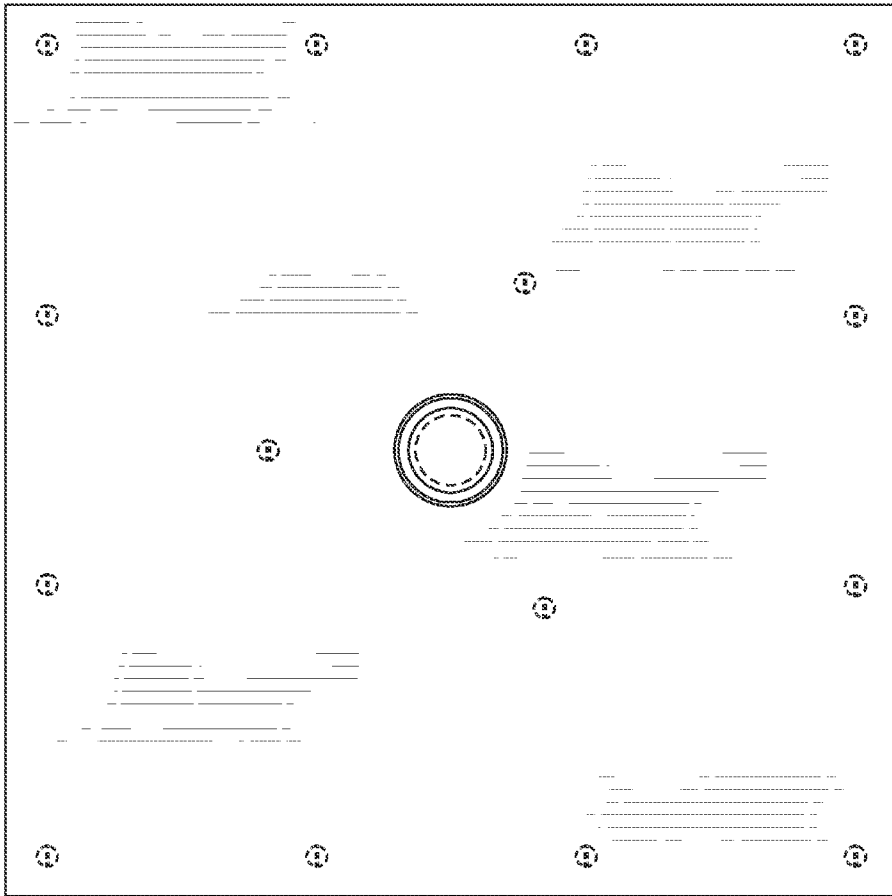

FIG. 47

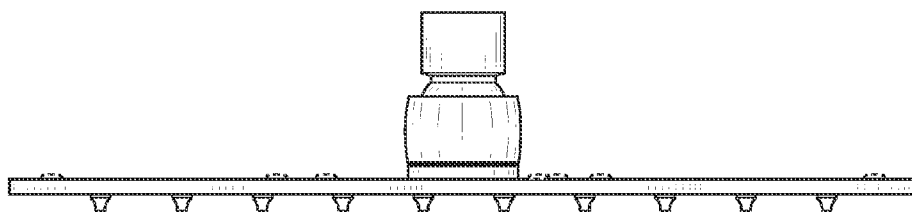

FIG. 48

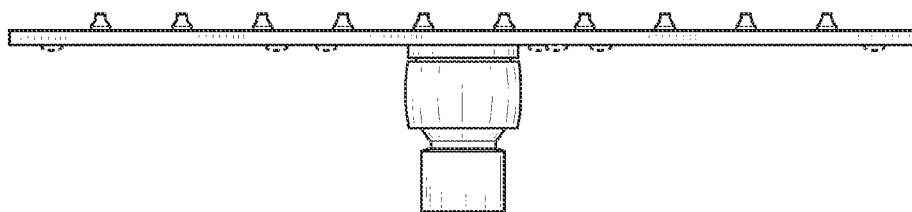

FIG. 49

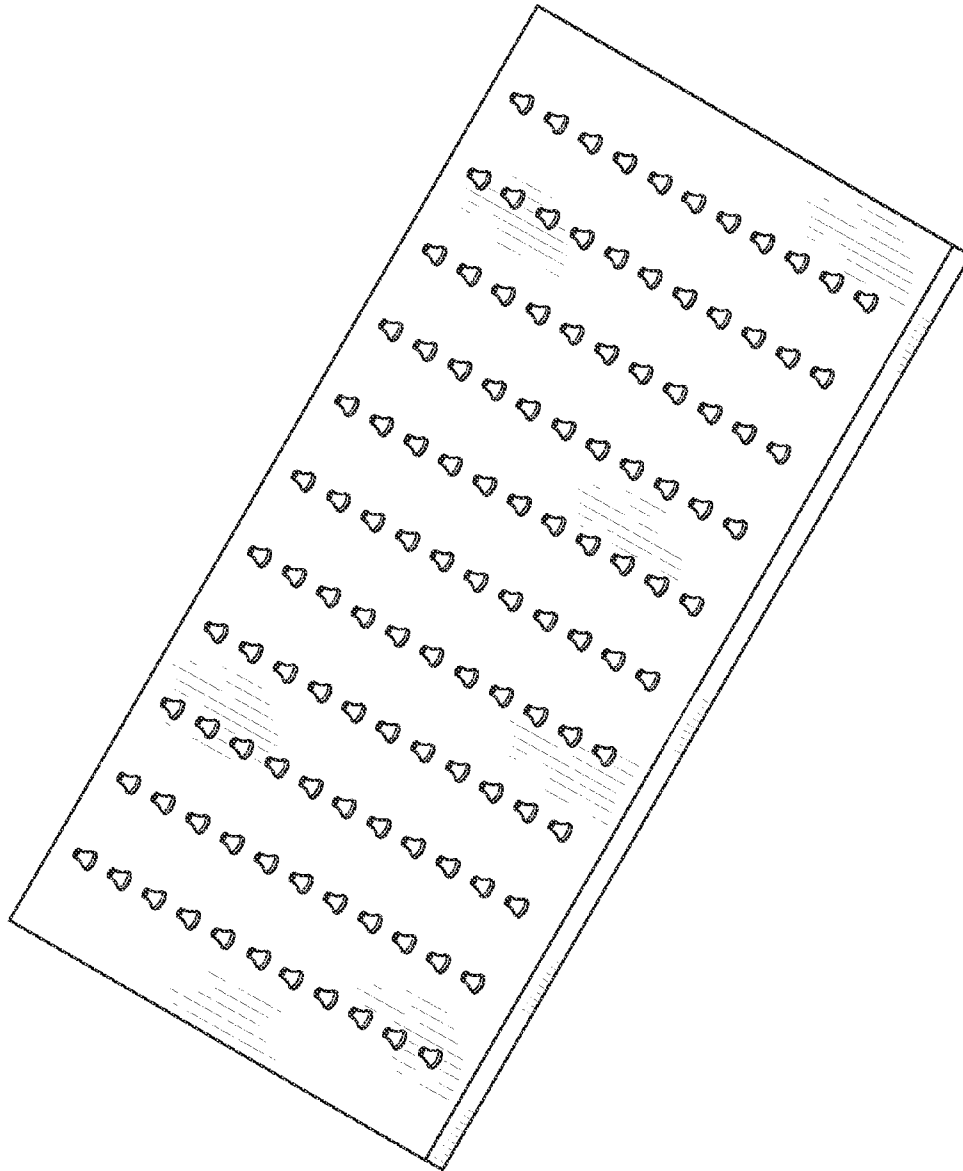

FIG. 50

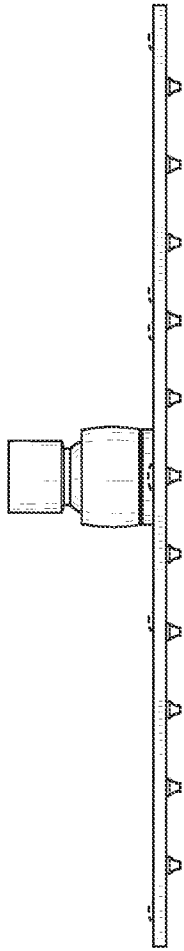

FIG. 51

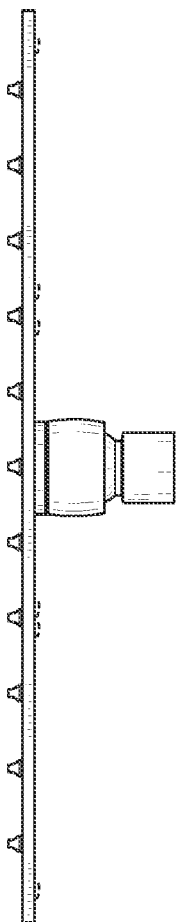

FIG. 52

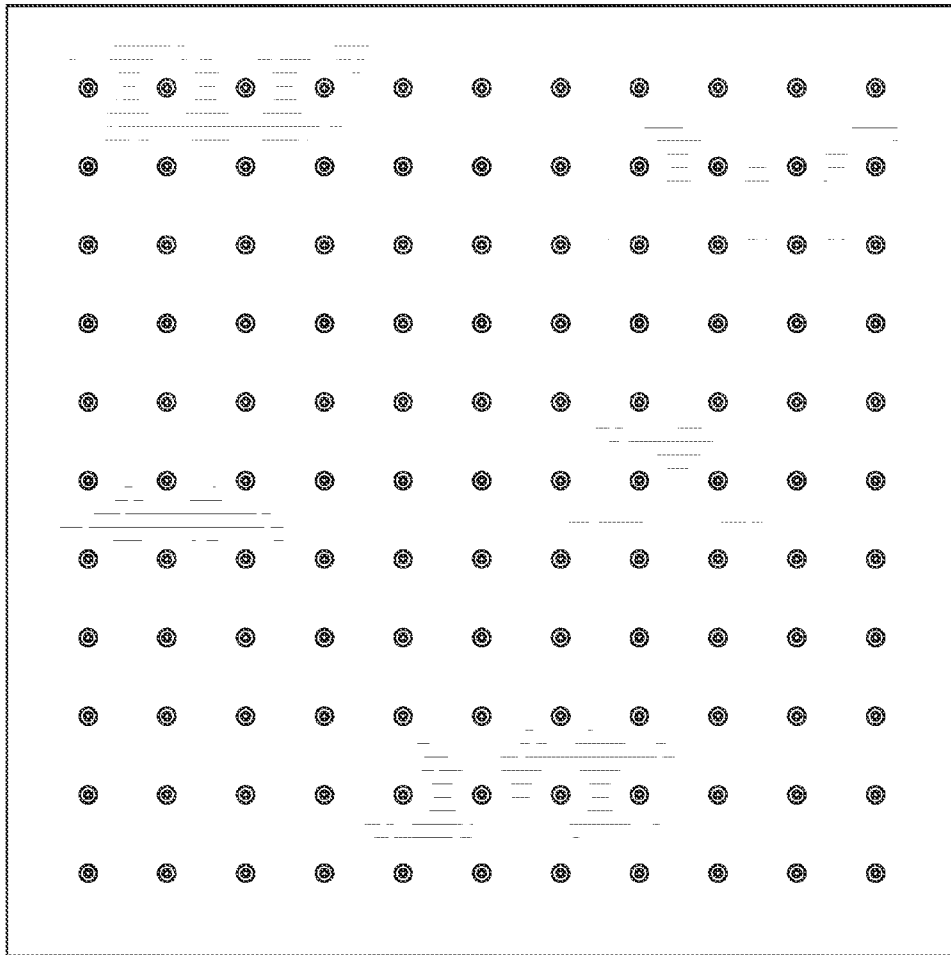

FIG. 53

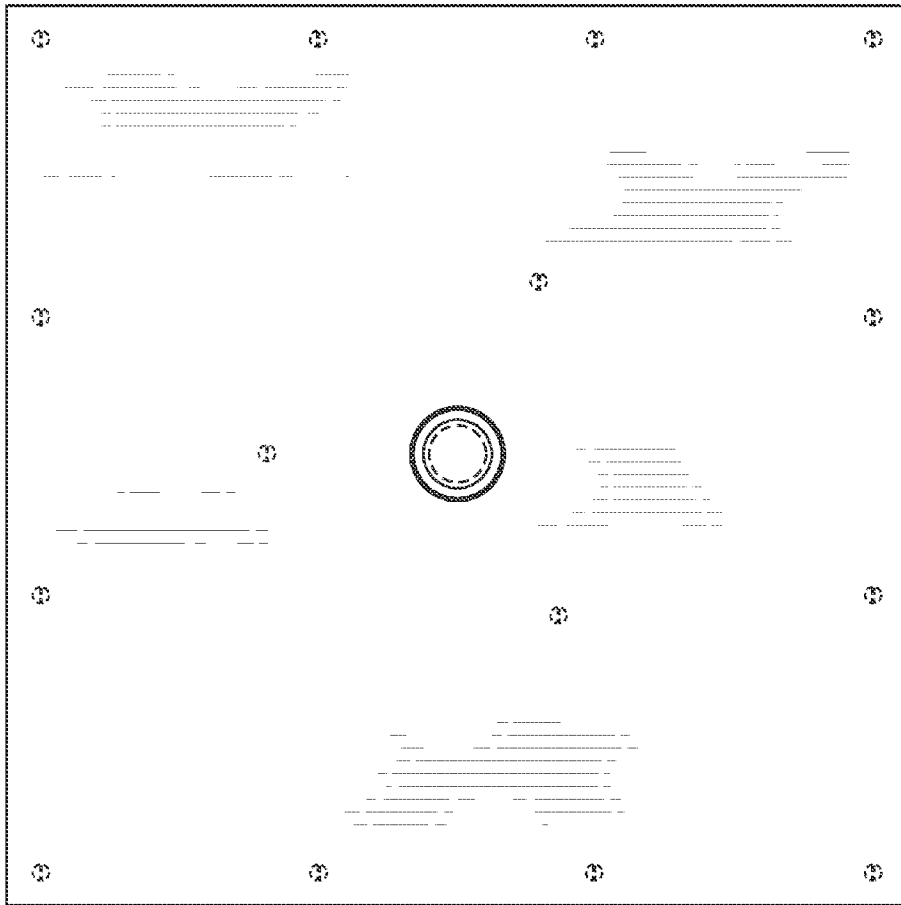

FIG. 54

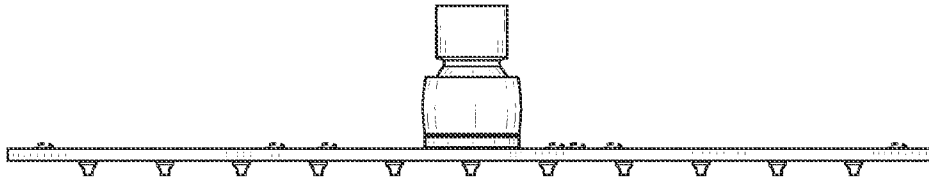

FIG. 55

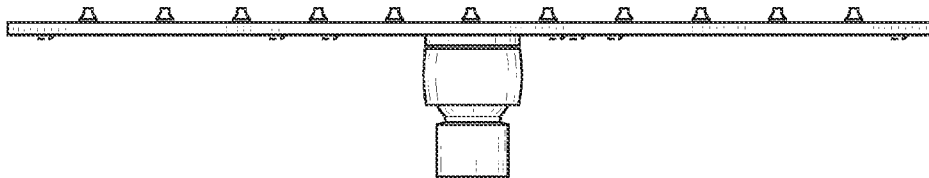

FIG. 56