



US00D803839S

(12) **United States Design Patent**
Lin

(10) **Patent No.:** **US D803,839 S**

(45) **Date of Patent:** **** Nov. 28, 2017**

(54) **CONNECTOR FOR ELECTRONIC DEVICE**

(71) Applicant: **ZEROPLUS TECHNOLOGY CO., LTD.**, New Taipei (TW)

(72) Inventor: **Chih-Ying Lin**, New Taipei (TW)

(73) Assignee: **ZEROPLUS TECHNOLOGY CO., LTD.**, New Taipei (TW)

(**) Term: **15 Years**

(21) Appl. No.: **29/571,241**

(22) Filed: **Jul. 15, 2016**

(51) **LOC (10) Cl.** **14-02**

(52) **U.S. Cl.**
USPC **D14/433**

(58) **Field of Classification Search**
USPC D14/356, 432-434, 453, 454, 511, 203.8,
D14/209.1, 238.1, 240, 125; 439/638,
439/928, 105, 502; 710/303, 304;
361/679.41, 679.55, 679.56; D13/110,
D13/133, 146
CPC G06Q 20/202; G06Q 20/322; G06Q 20/32;
G06Q 20/20; G06Q 20/327
See application file for complete search history.

(56) **References Cited**

U.S. PATENT DOCUMENTS

D482,693 S * 11/2003 Nishio D14/432
D493,175 S * 7/2004 Schmidt D13/110

D575,785 S * 8/2008 Chang D14/432
D688,248 S * 8/2013 Tsuda D14/433
D702,242 S * 4/2014 Tsuda D14/433
D717,803 S * 11/2014 Takano D14/433
D729,807 S * 5/2015 Hsu D14/433
D740,291 S * 10/2015 Turksu D14/433
D745,523 S * 12/2015 Magi D14/433
D786,874 S * 5/2017 Eliyahu D14/433
D789,372 S * 6/2017 Trishaun D14/433

* cited by examiner

Primary Examiner — Austin Murphy

(74) *Attorney, Agent, or Firm* — Tracy Heims; Apex Juris, pllc

(57) **CLAIM**

The ornamental design for a connector for an electronic device, as shown and described herein.

DESCRIPTION

FIG. 1 is a perspective view of the connector;
FIG. 2 is a front view of the connector;
FIG. 3 is a rear view of the connector;
FIG. 4 is a left side view of the connector;
FIG. 5 is a right side view of the connector;
FIG. 6 is a top view of the connector; and,
FIG. 7 is a bottom view of the connector.

1 Claim, 7 Drawing Sheets

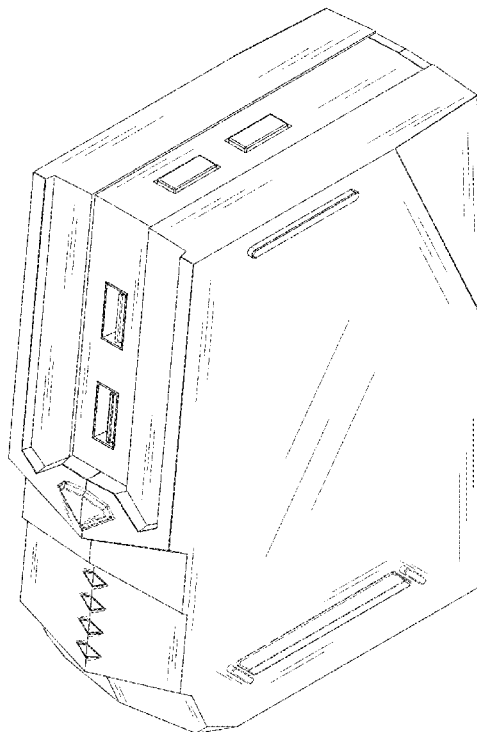

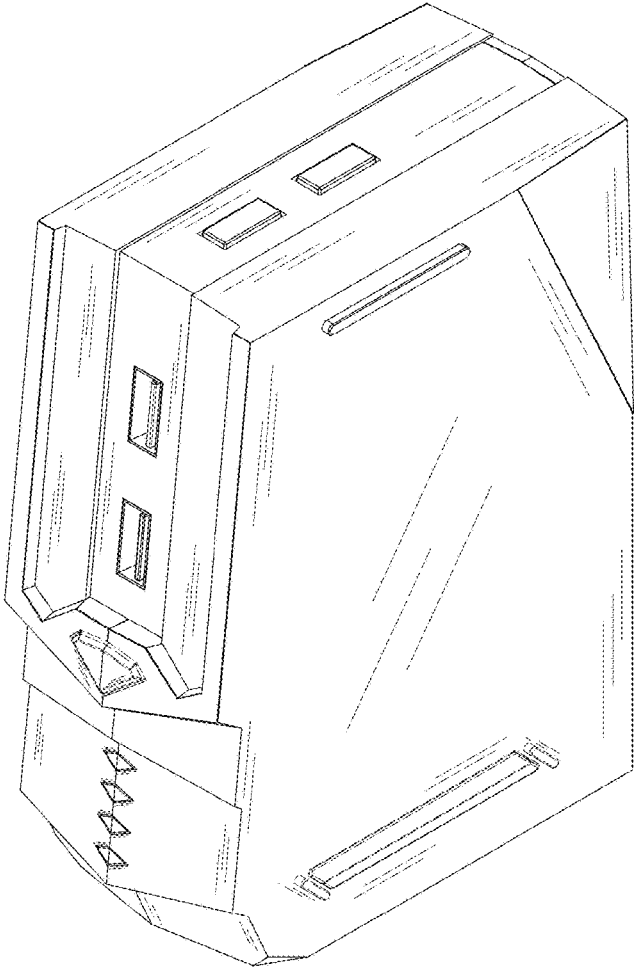

FIG. 1

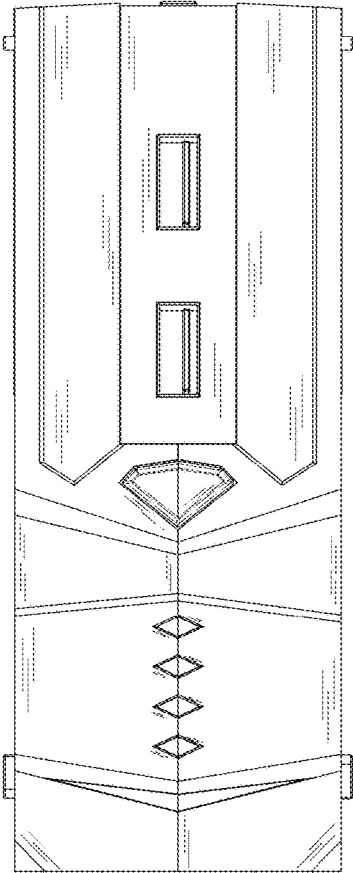

FIG. 2

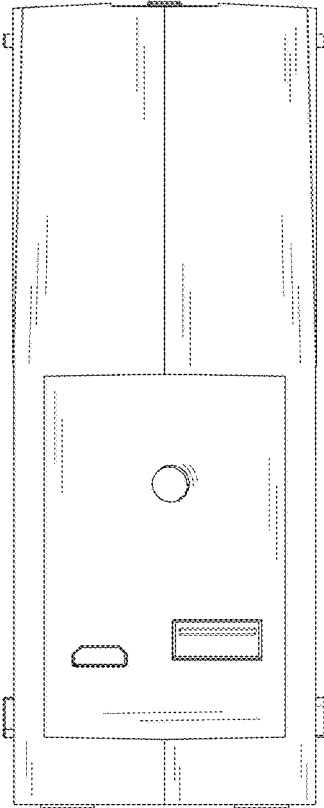

FIG. 3

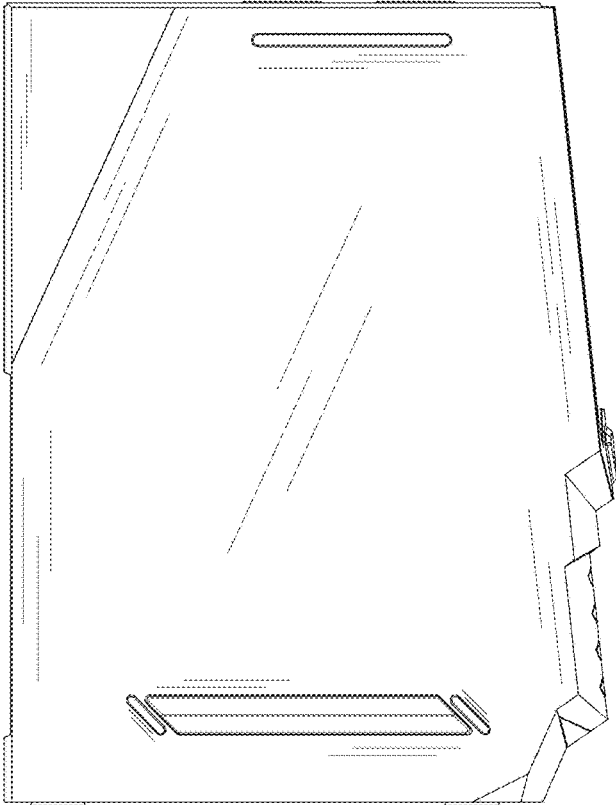

FIG. 4

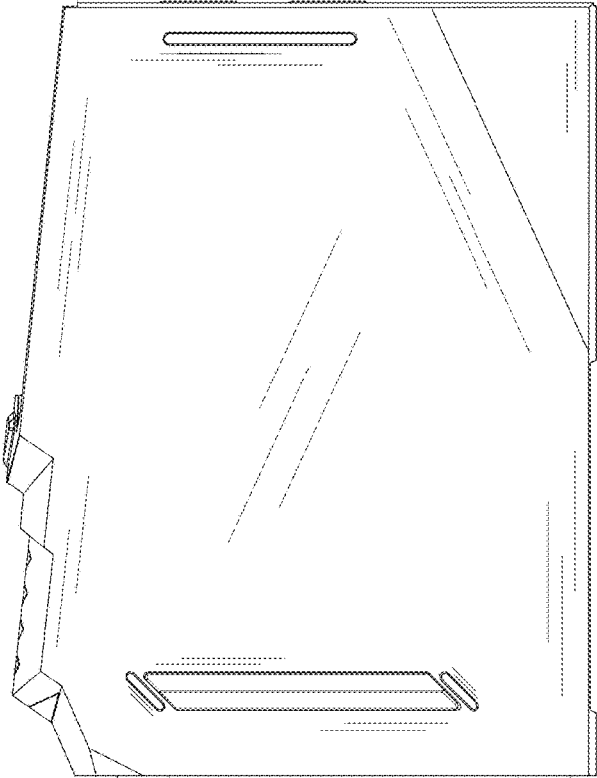

FIG. 5

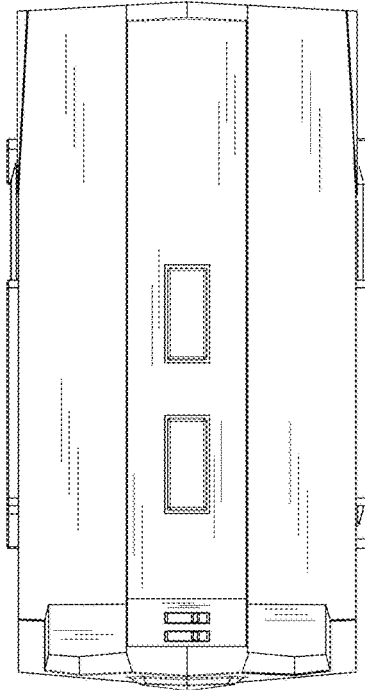

FIG. 6

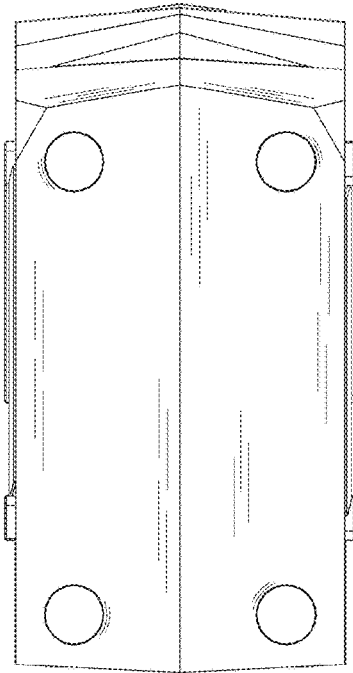

FIG. 7