



US00D847770S

(12) **United States Design Patent** (10) **Patent No.:** **US D847,770 S**
Won et al. (45) **Date of Patent:** **** May 7, 2019**

(54) **TELEVISION**
(71) Applicant: **LG ELECTRONICS INC., Seoul (KR)**
(72) Inventors: **Hyojin Won, Seoul (KR); Hyeyoung Hong, Seoul (KR); Yongho Lee, Seoul (KR); Youngkyoung Kim, Seoul (KR)**
(73) Assignee: **LG ELECTRONICS INC., Seoul (KR)**
(**) Term: **15 Years**
(21) Appl. No.: **35/504,039**
(22) Filed: **May 25, 2017**

D718,730 S * 12/2014 Andresen D14/126
D728,500 S * 5/2015 Park D14/126
D731,994 S * 6/2015 Won D14/126
D733,083 S * 6/2015 Hwangbo D14/126
D738,336 S * 9/2015 Hwangbo D14/126
D741,276 S * 10/2015 Shin D14/126
D768,100 S * 10/2016 Seo D14/126
D772,833 S * 11/2016 Han D14/126
D773,419 S * 12/2016 Han D14/126
D775,094 S * 12/2016 Kim D14/126
D777,697 S * 1/2017 Kim D14/126
D790,493 S * 6/2017 Han D14/126
D791,094 S * 7/2017 Han D14/126
D792,361 S * 7/2017 Han D14/126
D799,440 S * 10/2017 Kim D14/126
D799,441 S * 10/2017 Park D14/126
D799,442 S * 10/2017 Park D14/126
D805,049 S * 12/2017 Lim D14/126

(Continued)

(80) **Hague Agreement Data**
Int. Filing Date: **May 25, 2017**
Int. Reg. No.: **DM/096325**
Int. Reg. Date: **May 25, 2017**
Int. Reg. Pub. Date: **Dec. 1, 2017**

Primary Examiner — Karen E Kearney
Assistant Examiner — Bao-Yen T Nguyen
(74) *Attorney, Agent, or Firm* — Birch, Stewart, Kolasch & Birch, LLP

(30) **Foreign Application Priority Data**
Nov. 25, 2016 (KR) 30-2016-0056914
(51) **LOC (11) Cl.** **14-03**
(52) **U.S. Cl.**
USPC **D14/126**
(58) **Field of Classification Search**
USPC D14/125–134, 136, 159, 239, 336, 342,
D14/371, 374–377, 440, 448, 450;
D21/329, 515, 577, 622
CPC ... G06F 1/1601; G06F 1/1643; H05K 5/0004;
H05K 5/0017; H05K 5/02; H05K 5/0217
See application file for complete search history.

(57) **CLAIM**
The ornamental design for a television, as shown and described.

(56) **References Cited**
U.S. PATENT DOCUMENTS
D701,185 S * 3/2014 McManigal D14/126
D715,756 S * 10/2014 Lim D14/126

DESCRIPTION
1. Television
1.1 : Perspective
1.2 : Front
1.3 : Back
1.4 : Left
1.5 : Right
1.6 : Top
1.7 : Bottom
1.8 : Enlarged
The dash-dot broken lines in 1.8 are included to show a partially enlarged view of 1.1 and form no part of the claimed design.

1 Claim, 8 Drawing Sheets

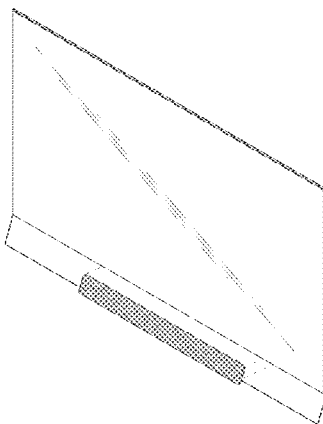

(56)

References Cited

U.S. PATENT DOCUMENTS

D813,831 S *	3/2018	Han	D14/126
D813,832 S *	3/2018	Kim	D14/126
D816,673 S *	5/2018	Lim	D14/374

* cited by examiner

1.1

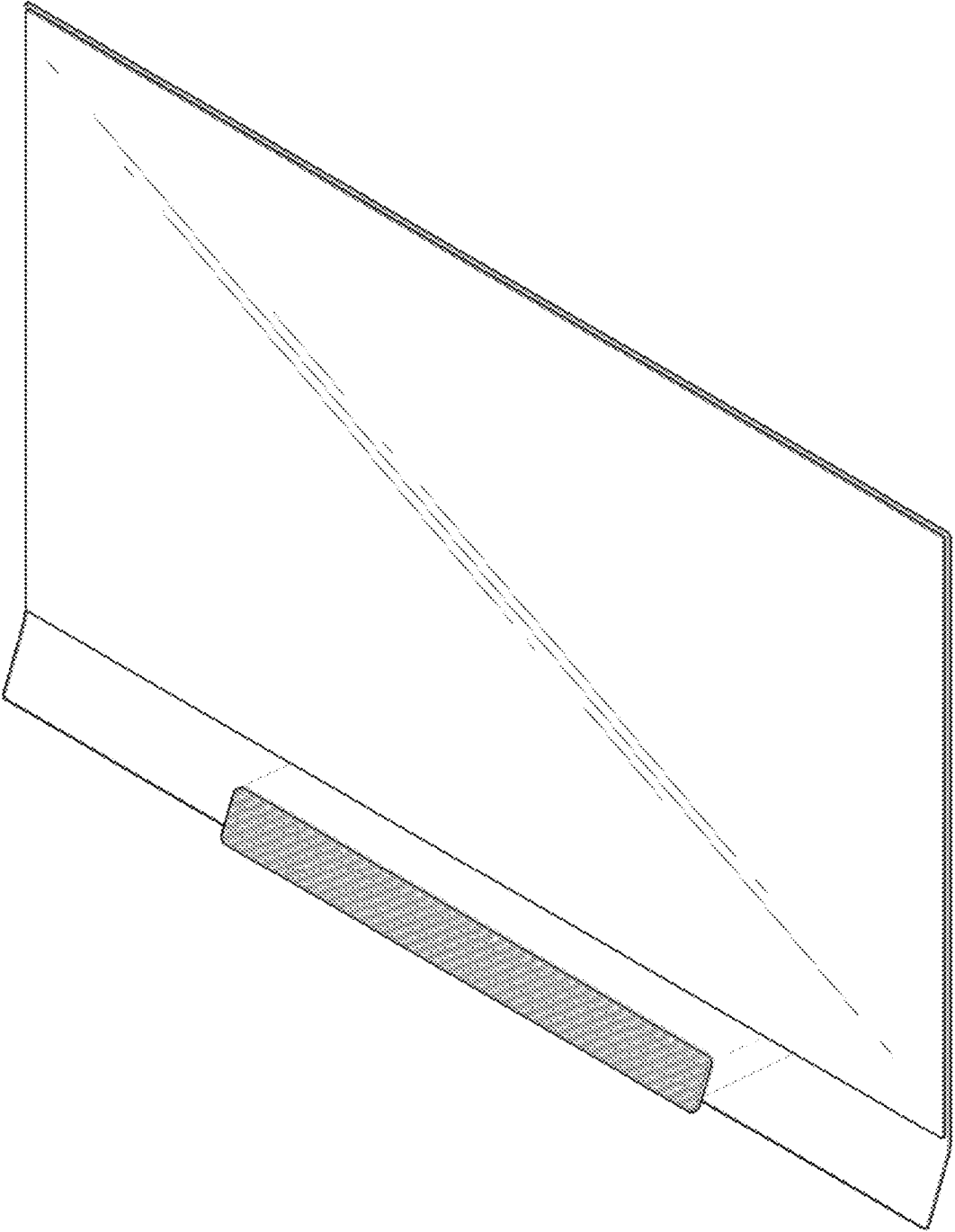

1.2

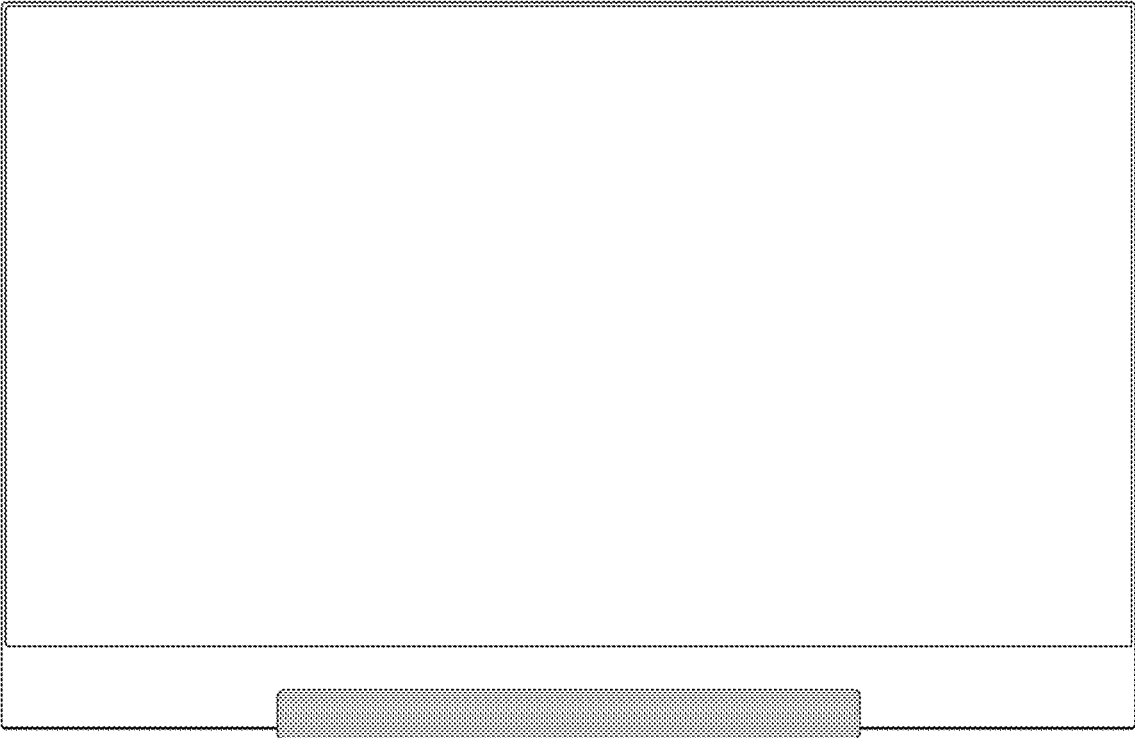

1.3

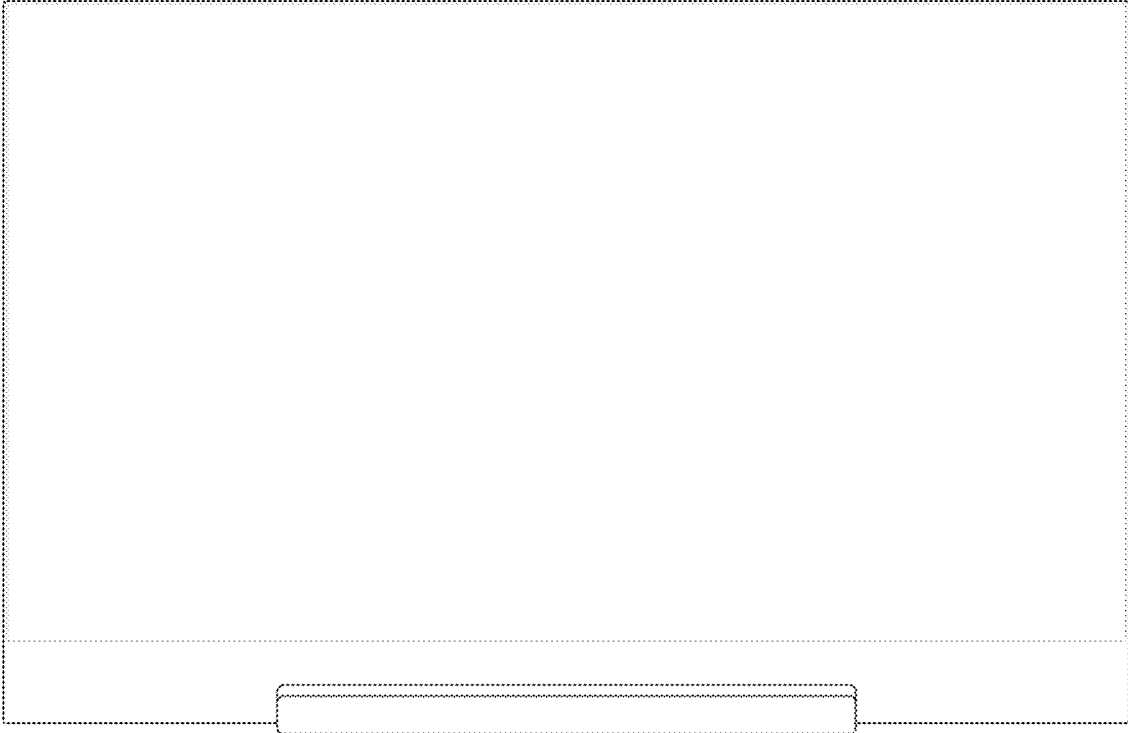

1.4

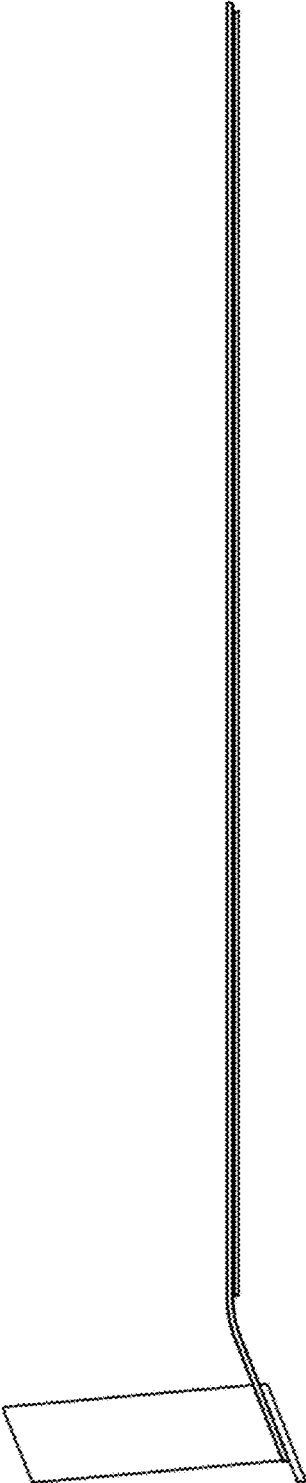

1.5

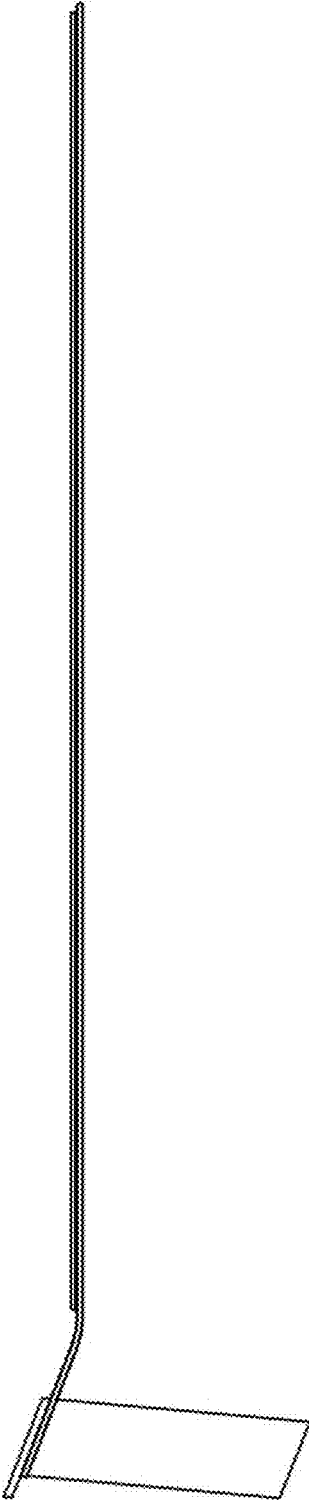

1.6

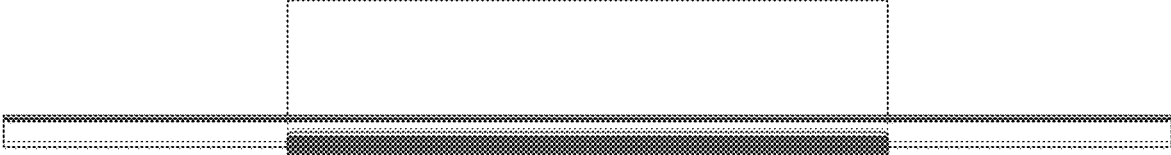

1.7

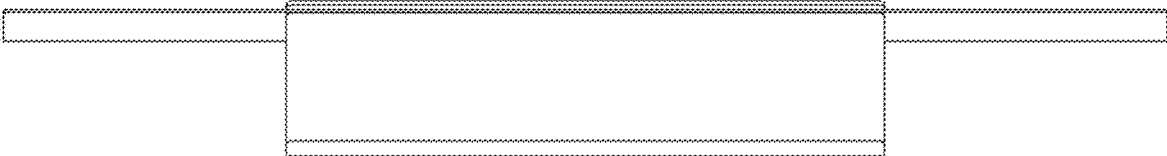

1.8

