



US00D808594S

(12) **United States Design Patent**  
**Tien**

(10) **Patent No.:** **US D808,594 S**

(45) **Date of Patent:** **\*\* Jan. 23, 2018**

- (54) **QUICK RELEASE BODY ARMOR**
- (71) Applicant: **Spencer Tien**, Irwindale, CA (US)
- (72) Inventor: **Spencer Tien**, Irwindale, CA (US)
- (\*\*) Term: **15 Years**
- (21) Appl. No.: **29/587,159**
- (22) Filed: **Dec. 9, 2016**
- (51) **LOC (11) Cl.** ..... **29-02**
- (52) **U.S. Cl.**  
USPC ..... **D29/101.4**
- (58) **Field of Classification Search**  
USPC ..... D29/100, 101, 101.2, 101.3, 101.4, 122,  
D29/124; D2/626, 829, 830, 860;  
362/108; D21/805; 441/88, 106, 108,  
441/111, 117; 182/3; 2/48, 51, 92, 102,  
2/103, 105, 913, 914, 915  
CPC ..... A41D 1/00; A45F 3/00  
See application file for complete search history.

- 8,826,462 B2 \* 9/2014 Storms, Jr. .... A41D 1/04  
2/102
- 8,898,914 B2 \* 12/2014 Bruder ..... F41G 1/467  
124/87
- D766,514 S \* 9/2016 Deng ..... D29/101.4

\* cited by examiner

*Primary Examiner* — Randall H Gholson

(74) *Attorney, Agent, or Firm* — Clement Cheng

(56) **References Cited**

**U.S. PATENT DOCUMENTS**

- 7,424,748 B1 \* 9/2008 McDunn ..... F41H 5/013  
2/102
- 8,353,065 B1 \* 1/2013 Crye ..... F41H 1/02  
2/102

(57) **CLAIM**

The ornamental design for a quick release body armor, as shown and described.

**DESCRIPTION**

FIG. 1 is a perspective view.  
 FIG. 2 is a front view.  
 FIG. 3 is a rear view.  
 FIG. 4 is a left side view.  
 FIG. 5 is a right side view.  
 FIG. 6 is a top view; and,  
 FIG. 7 is a bottom view.

The broken lines in the drawings show unclaimed subject matter only and form no part of the claimed design.

**1 Claim, 6 Drawing Sheets**

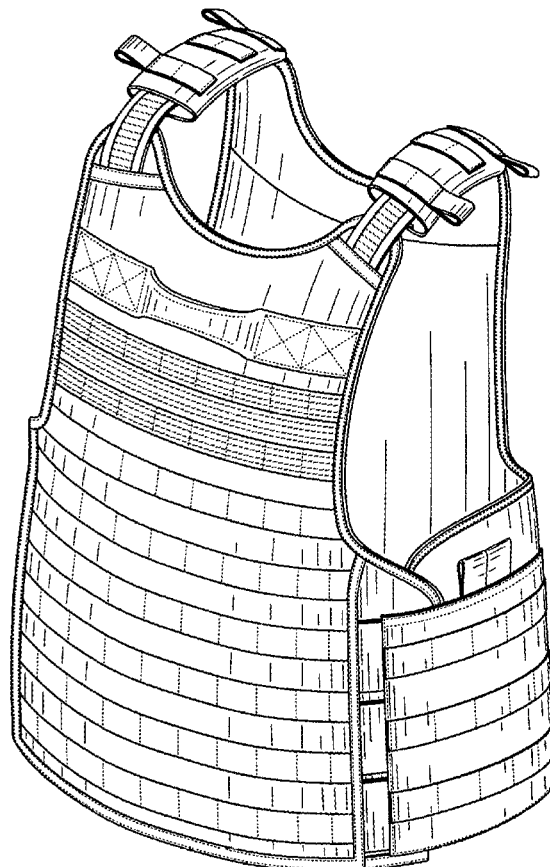

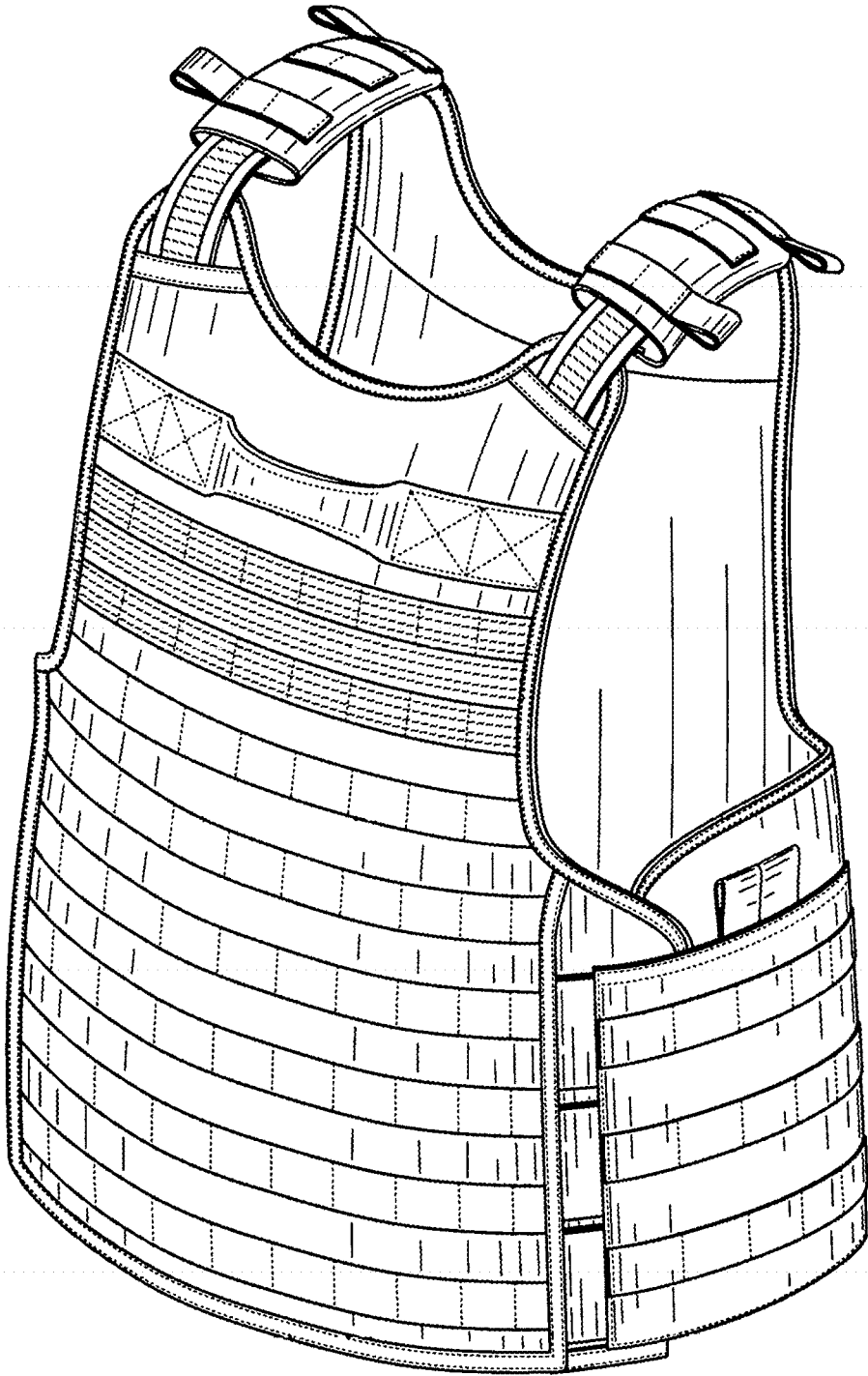

FIG. 1

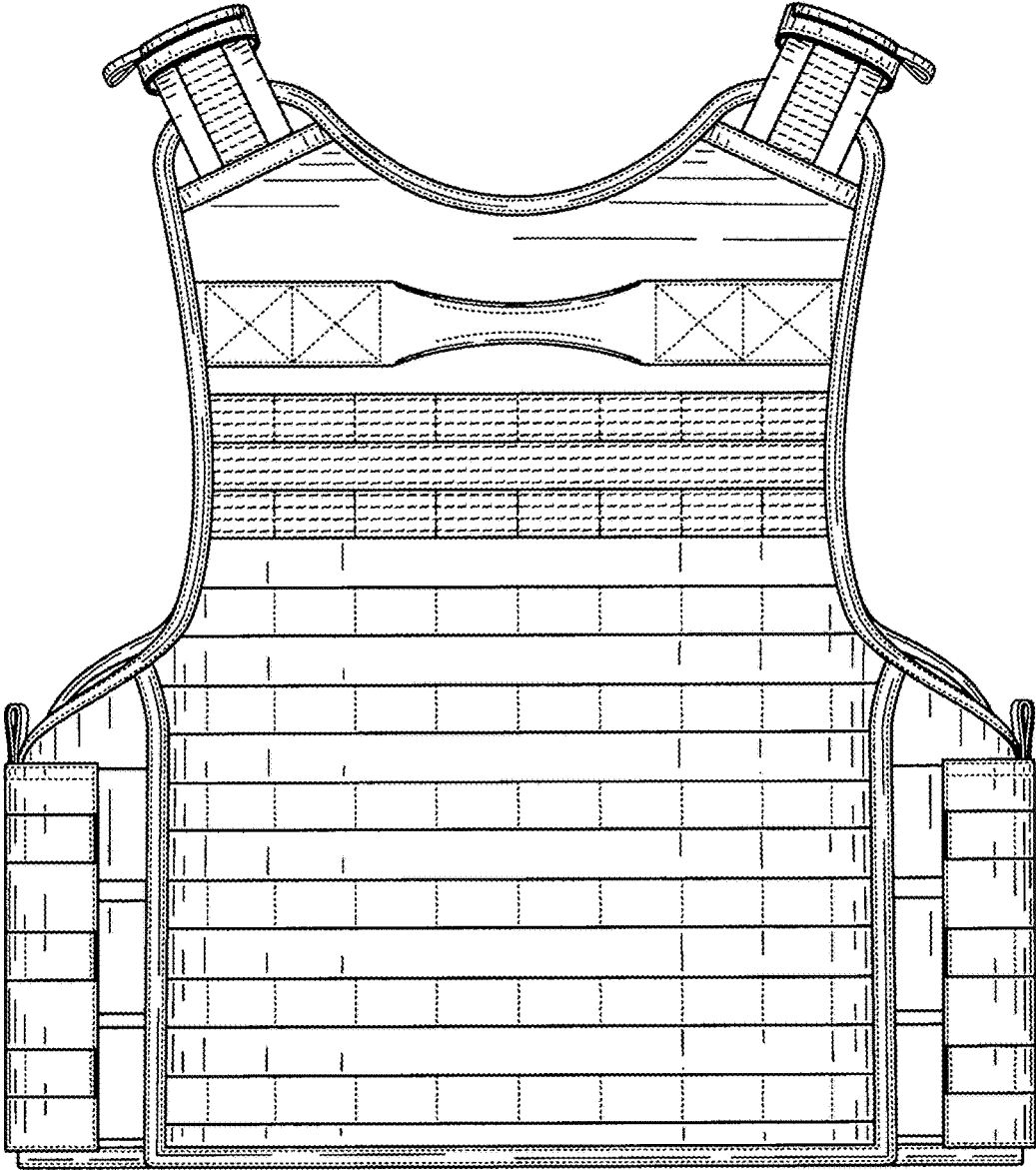

FIG. 2

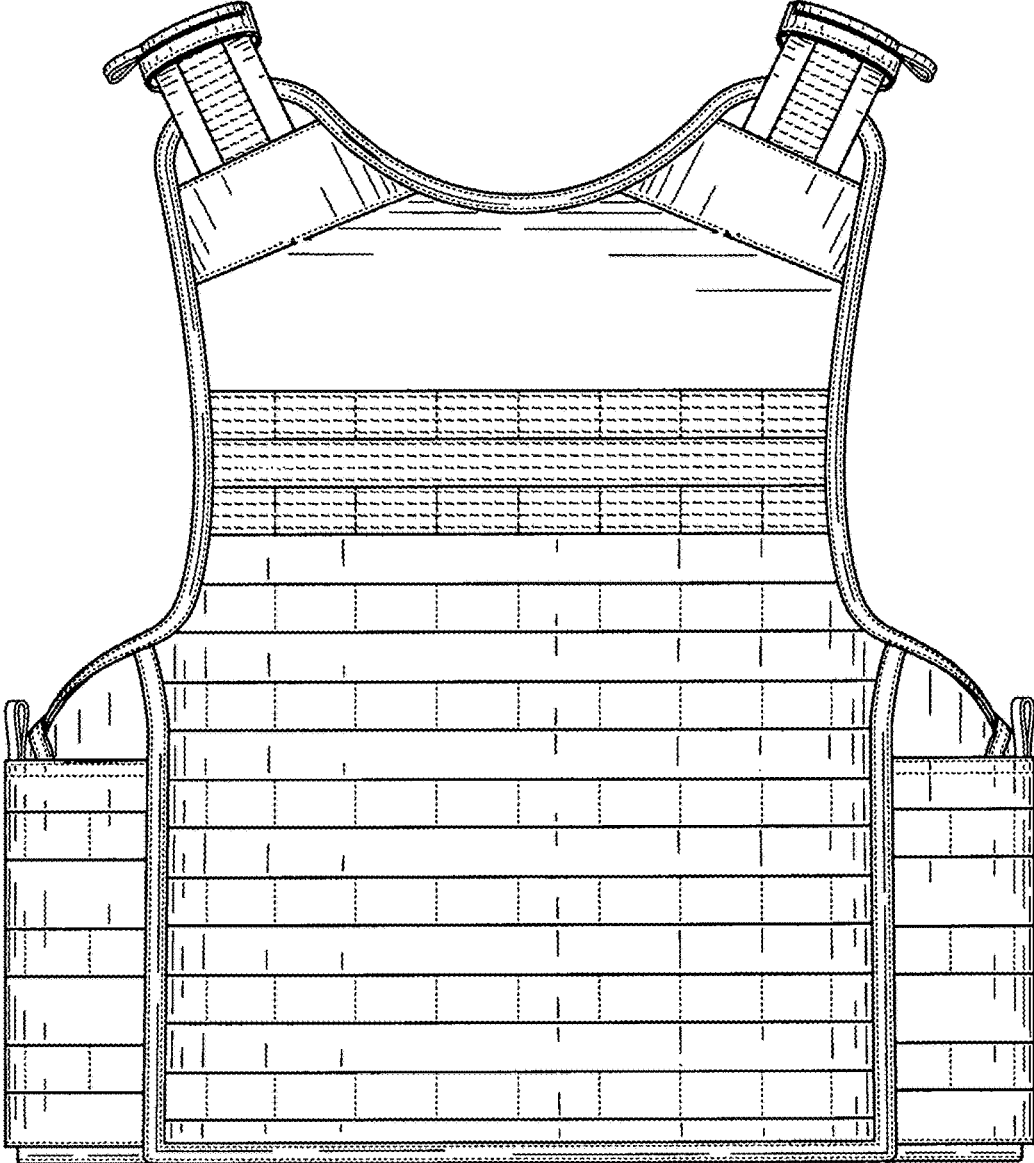

FIG. 3

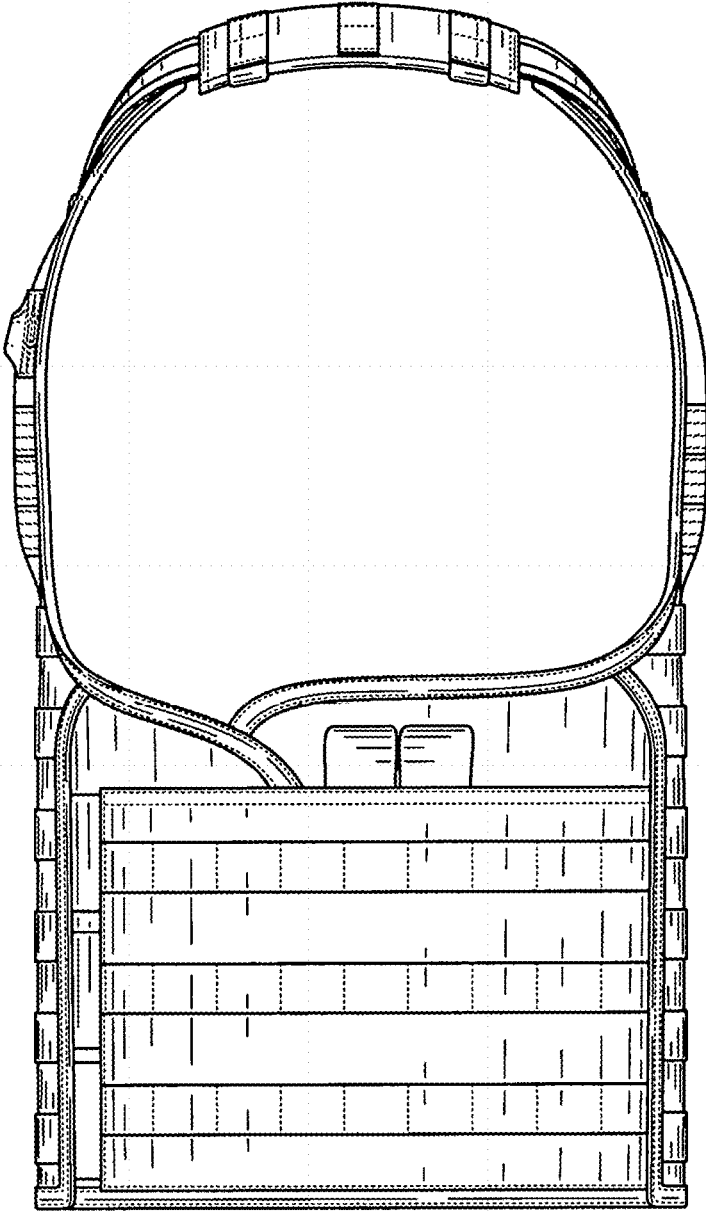

FIG. 4

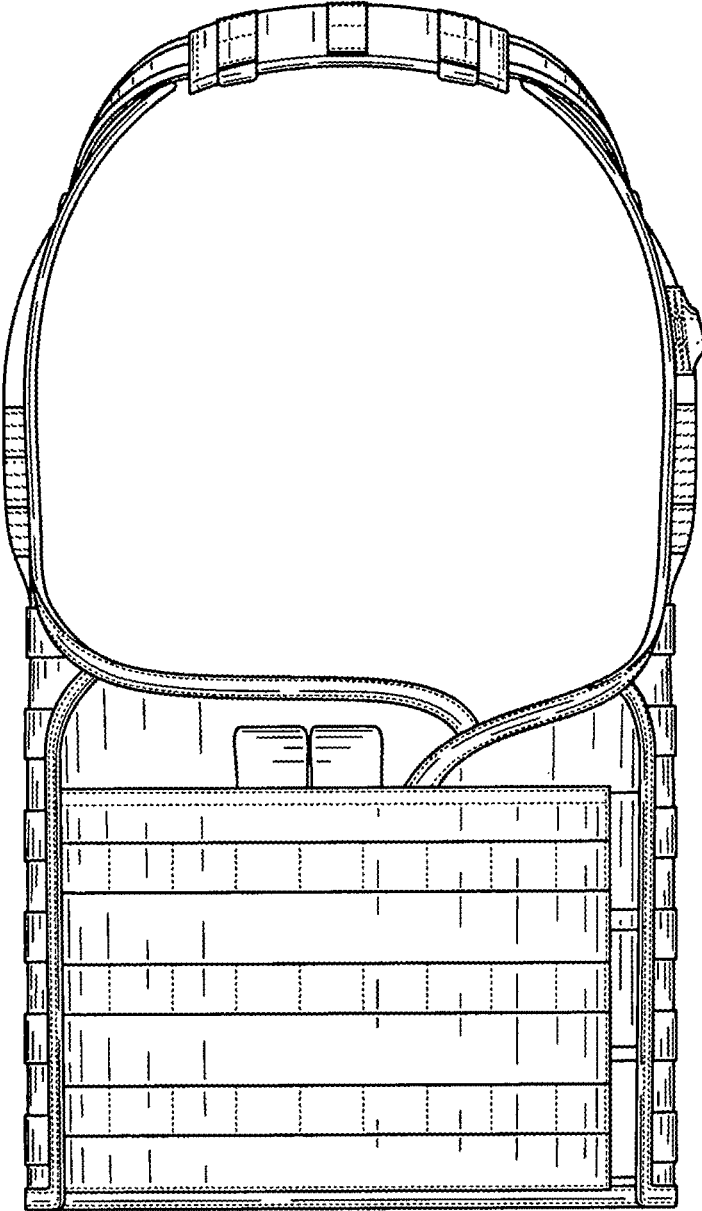

FIG. 5

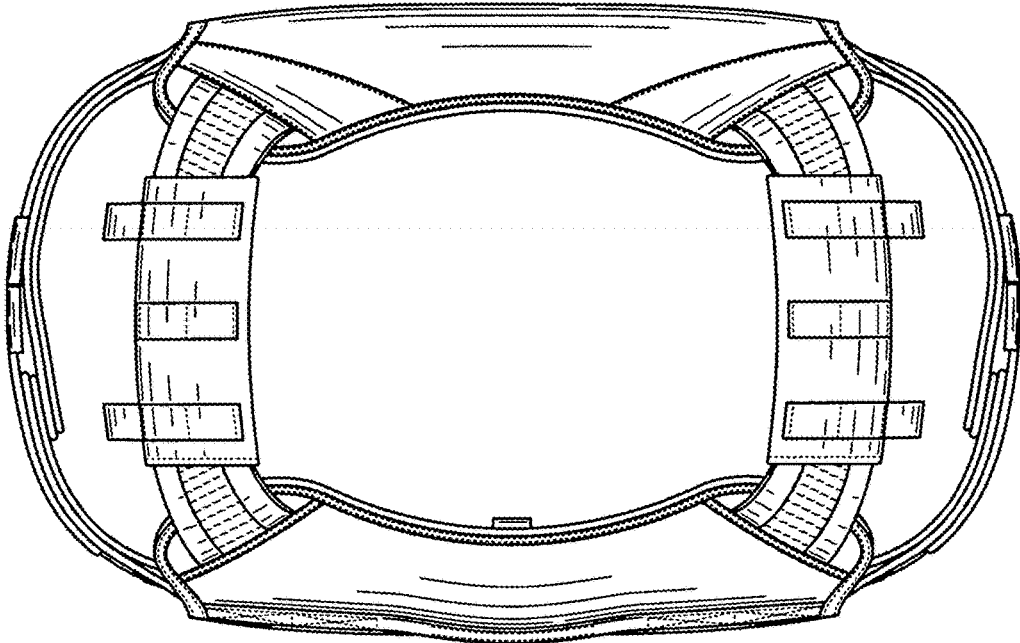

FIG. 6

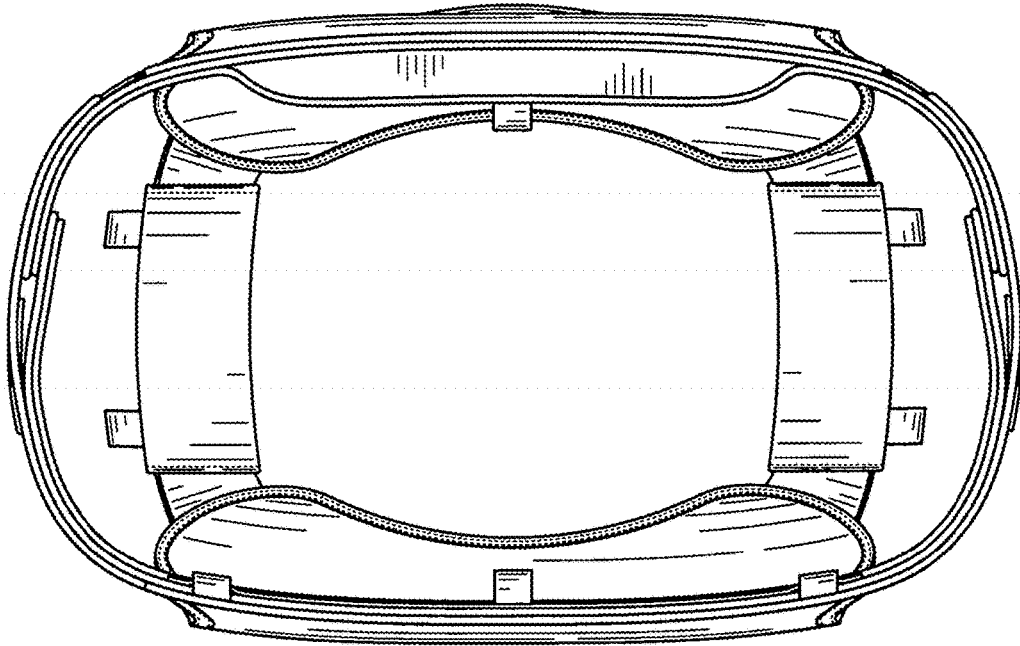

FIG. 7