



US00D898717S

(12) **United States Design Patent**
Seo et al.

(10) **Patent No.:** **US D898,717 S**
(45) **Date of Patent:** **** Oct. 13, 2020**

(54) **ELECTRONIC DEVICE**

Primary Examiner — Bridget L Eland
(74) *Attorney, Agent, or Firm* — NSIP Law

(71) Applicant: **Samsung Electronics Co., Ltd.**,
Suwon-si (KR)

(57) **CLAIM**

We claim the ornamental design for an electronic device, as shown and described.

(72) Inventors: **Joo-Ho Seo**, Seoul (KR); **Dong-Hun Kim**, Seoul (KR); **Han-Gil Song**, Seoul (KR); **Min-Hyounk Lee**, Bundang-gu (KR)

DESCRIPTION

(73) Assignee: **Samsung Electronics Co., Ltd.**,
Suwon-si (KR)

FIG. 1 is a front perspective view of a first embodiment of an electronic device showing our new design; FIG. 2 is a front view thereof; FIG. 3 is a rear view thereof; FIG. 4 is a left-side view thereof; FIG. 5 is a right-side view thereof; FIG. 6 is a top view thereof; FIG. 7 is a bottom view thereof; FIG. 8 is a rear perspective view; FIG. 9 is an enlarged view of the encircled portion in FIG. 6; FIG. 10 is an enlarged view of the encircled portion in FIG. 7; FIG. 11 is an enlarged view of the encircled portion in FIG. 8; FIG. 12 is a front perspective view of a second embodiment of an electronic device showing our new design; FIG. 13 is a front view thereof; FIG. 14 is a rear view thereof; FIG. 15 is a left-side view thereof; FIG. 16 is a right-side view thereof; FIG. 17 is a top view thereof; FIG. 18 is a bottom view thereof; and, FIG. 19 is a rear perspective view thereof. The evenly-spaced broken lines in the figures depict portions of the electronic device which form no part of the claimed design. The dot-dash broken lines in the figures define boundaries of the claimed design and form no part of the claimed design. The dot-dot-dash broken lines encircling portions of the claimed design that are illustrated in enlargements form no part of the embodiment in which they are shown.

(**) Term: **15 Years**

(21) Appl. No.: **29/686,051**

(22) Filed: **Apr. 2, 2019**

(30) **Foreign Application Priority Data**

Oct. 4, 2018 (KR) 30-2018-0045673

(51) **LOC (12) Cl.** **14-03**

(52) **U.S. Cl.**
USPC **D14/248**

(58) **Field of Classification Search**
USPC D14/138 G, 138 AD, 248, 341, 371, 374,
D14/138 R, 138 AA, 138 AB, 138 AC,
D14/138 C, 247

(Continued)

(56) **References Cited**

U.S. PATENT DOCUMENTS

D554,098 S * 10/2007 Lee D14/138 AD
D592,628 S * 5/2009 Kim D14/138 AD
(Continued)

FOREIGN PATENT DOCUMENTS

CN 2015304210998 4/2016
EM 002745273-0003 2/2016
EM 003361401-0001 12/2016

1 Claim, 19 Drawing Sheets

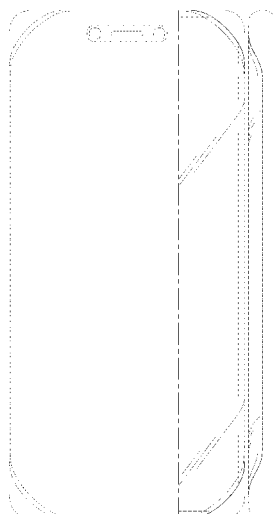

(58) **Field of Classification Search**

CPC H04M 1/0202; H04M 1/0235; H04M
1/0237; H04M 1/0239; H04M 1/0266;
H04M 1/0268; H04M 1/027; H04M
1/0295; H04M 1/02; H04M 1/0279;
H04M 1/0283

See application file for complete search history.

(56) **References Cited**

U.S. PATENT DOCUMENTS

D611,025 S * 3/2010 Yu D14/138 G
D618,646 S * 6/2010 Wykes D14/138 AD
D619,989 S * 7/2010 Huang D14/138 AD
D638,814 S * 5/2011 Sutherland D14/138 G
D656,118 S * 3/2012 Kim D14/138 G
D678,232 S * 3/2013 Harmon D14/138 G
D681,590 S * 5/2013 Han D14/138 G
D691,576 S * 10/2013 Lee D14/138 G
D712,864 S * 9/2014 Hirota D14/138 G
D750,589 S * 3/2016 Kim D14/138 G
D751,051 S * 3/2016 Cho D14/138 G
D763,837 S * 8/2016 Choe D14/248
D768,594 S 10/2016 Szeto

D783,563 S 4/2017 Choo et al.
D785,612 S * 5/2017 Kim D14/248
D786,226 S * 5/2017 Kim D14/248
D797,089 S * 9/2017 Lee D14/248
D797,090 S * 9/2017 Lee D14/248
D797,726 S * 9/2017 Lee D14/341
D800,083 S * 10/2017 Park D14/138 G
D803,822 S * 11/2017 Lee D14/248
D816,649 S * 5/2018 Song D14/248
D845,288 S * 4/2019 Park D14/248
D846,522 S * 4/2019 Lee D14/138 G
D854,523 S * 7/2019 Kim D14/248
D854,525 S * 7/2019 Choi D14/248
D860,178 S * 9/2019 Song D14/248
D864,934 S * 10/2019 Park D14/248
D866,541 S * 11/2019 Park D14/248
D866,542 S * 11/2019 Park D14/248
D867,349 S * 11/2019 Kim D14/248
D868,050 S * 11/2019 Song D14/248
D868,763 S * 12/2019 Kim D14/248
D870,088 S * 12/2019 Kim D14/248
D876,416 S * 2/2020 Park D14/248
D877,129 S * 3/2020 Kim D14/248
D882,541 S * 4/2020 Xu D14/138 G
D882,556 S * 4/2020 Kim D14/248

* cited by examiner

FIG. 1

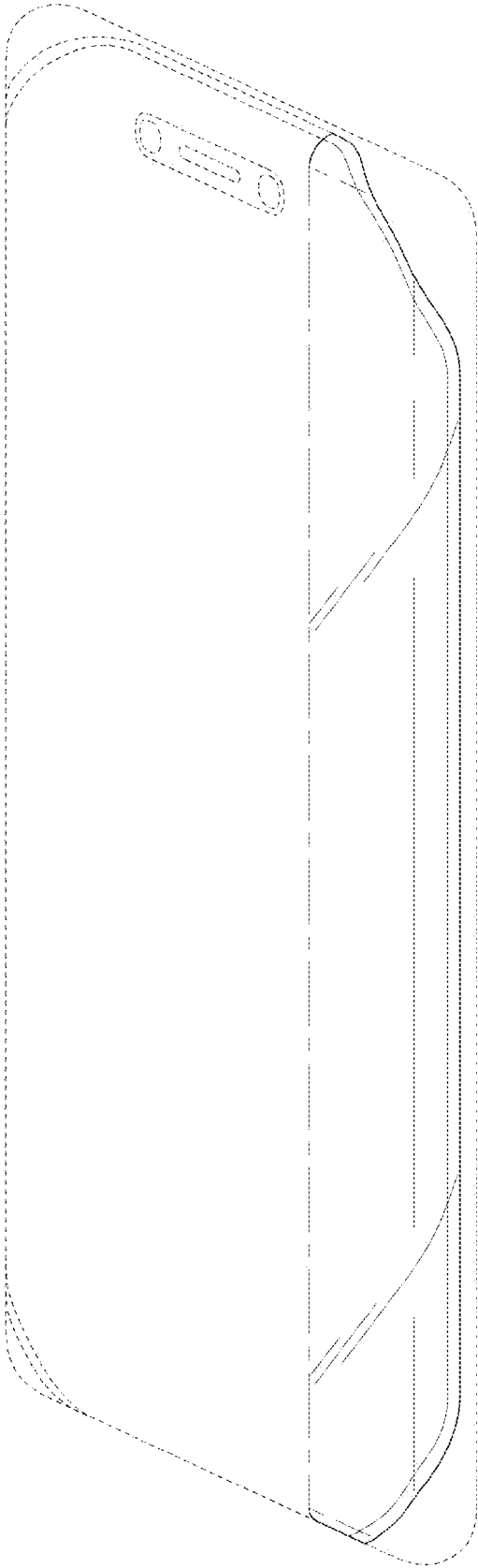

FIG. 2

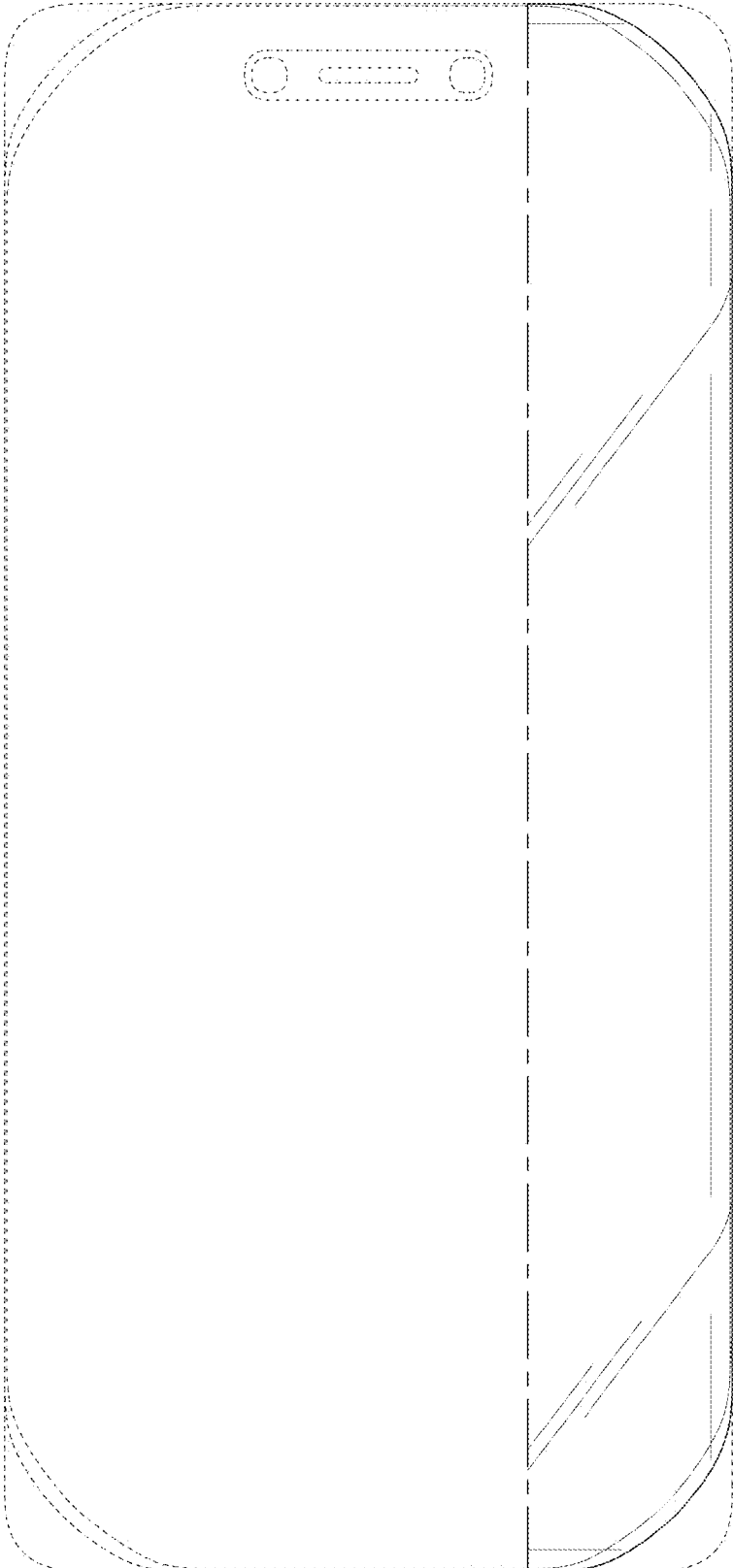

FIG. 3

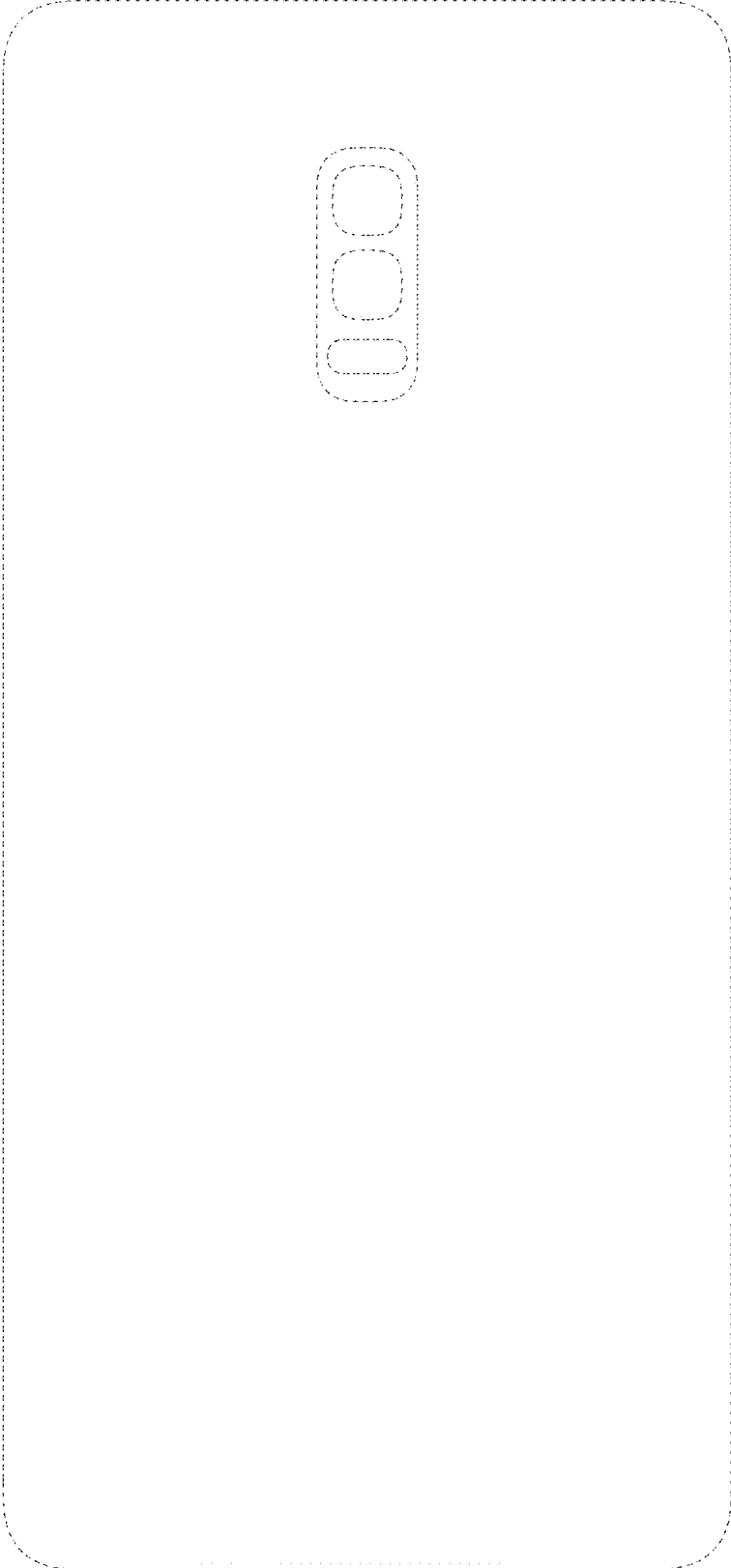

FIG. 4

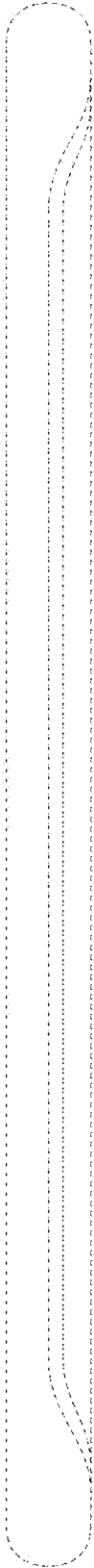

FIG. 5



FIG. 6

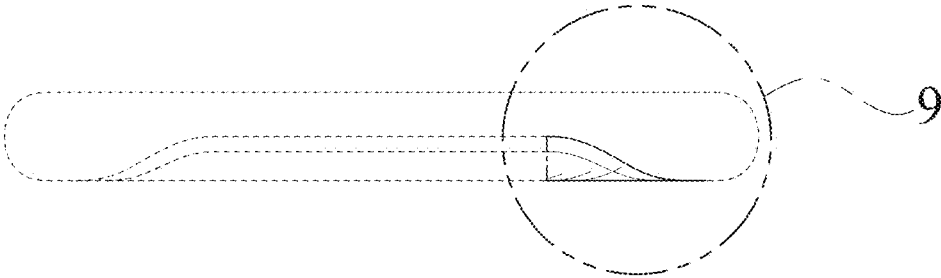

FIG. 7

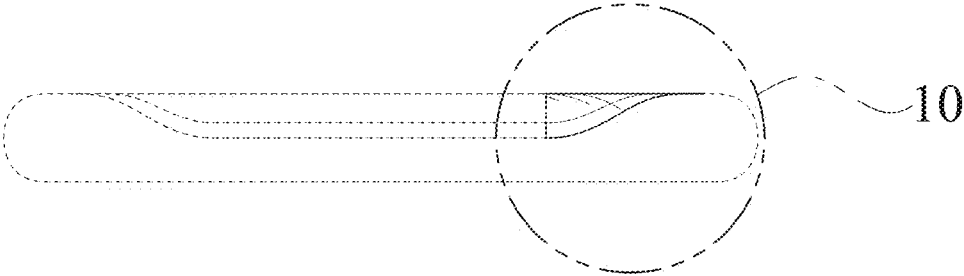

FIG. 8

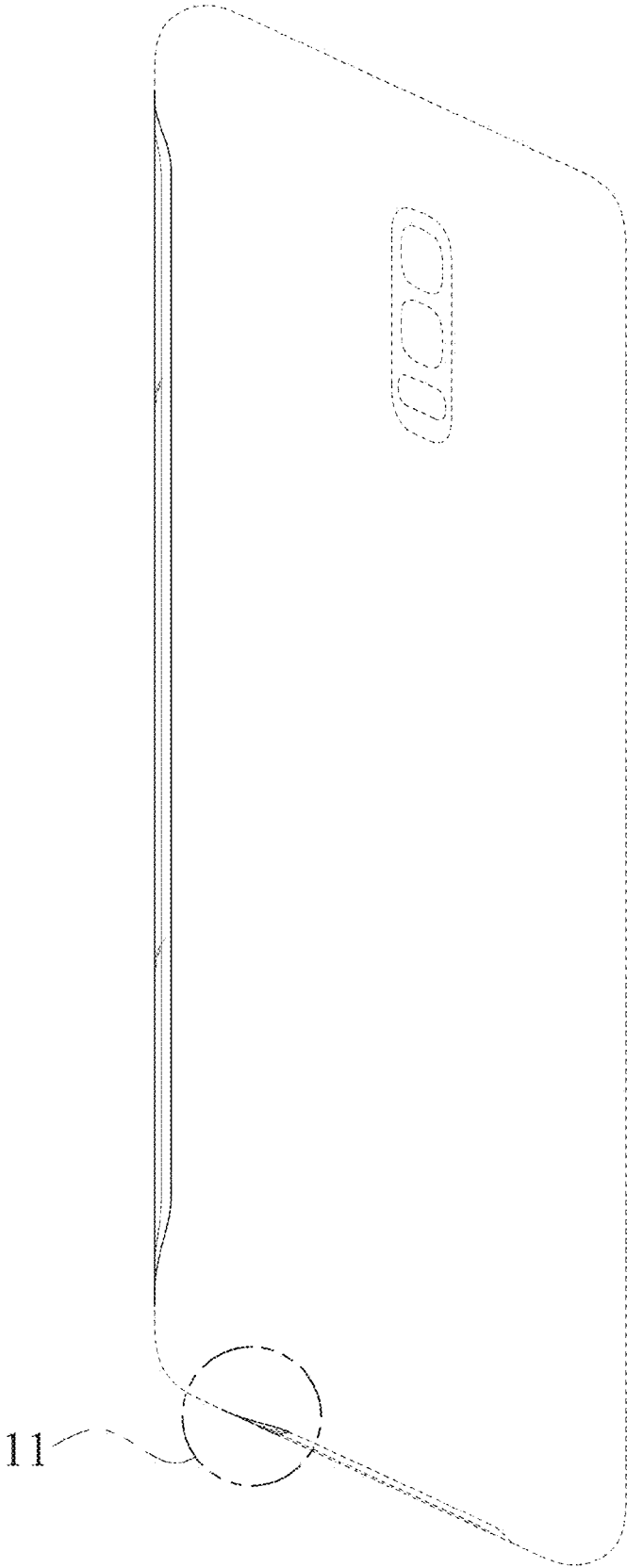

FIG. 9

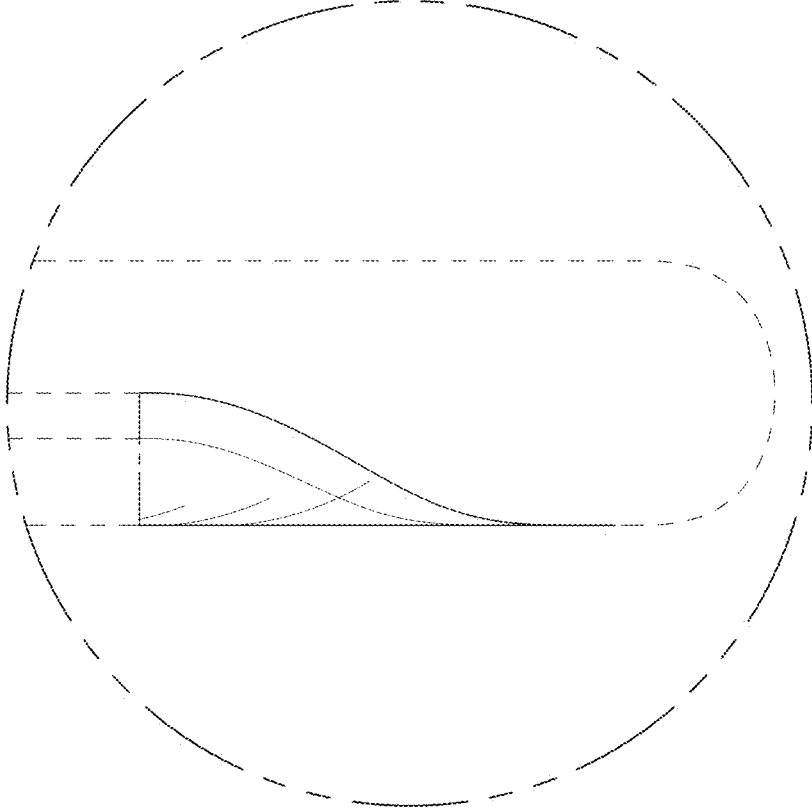

FIG. 10

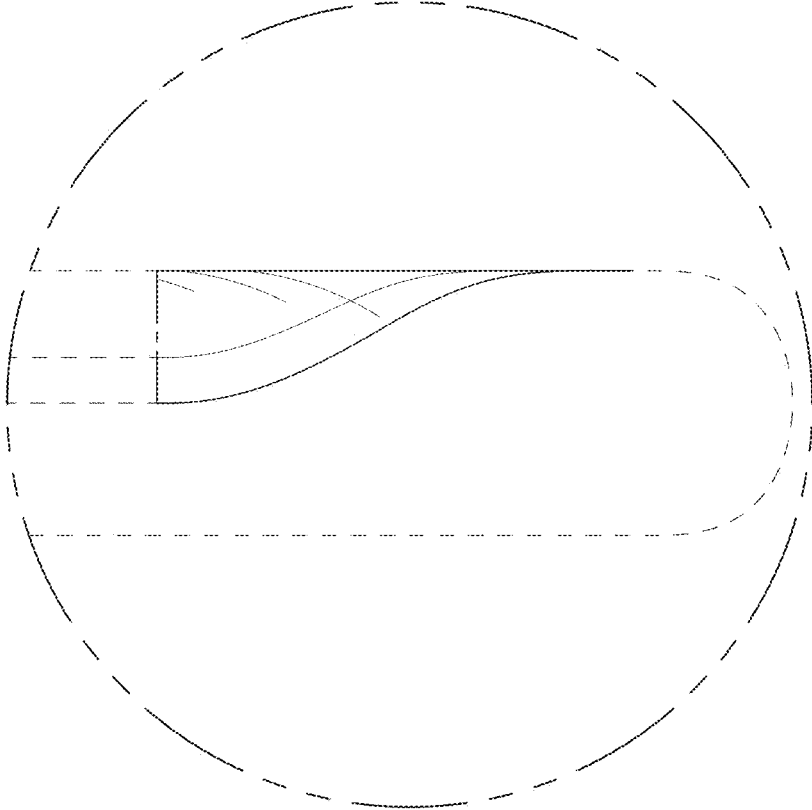

FIG. 11

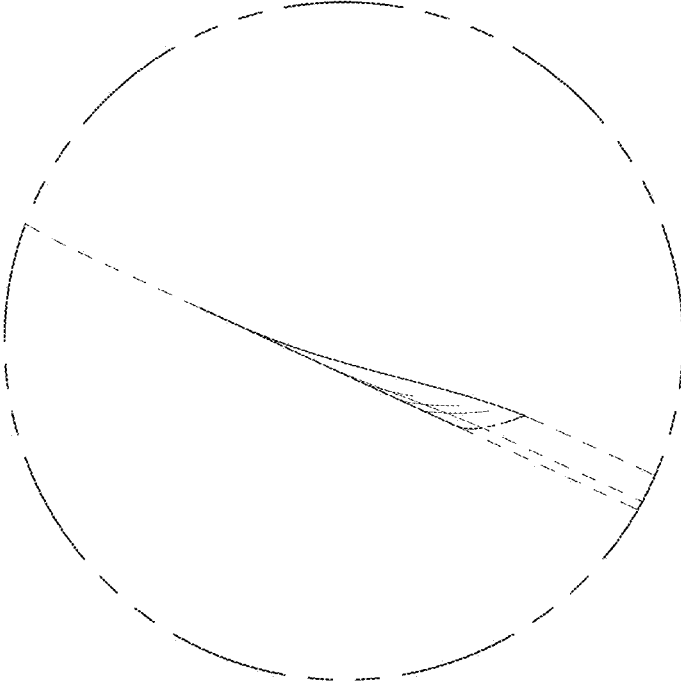

FIG. 12

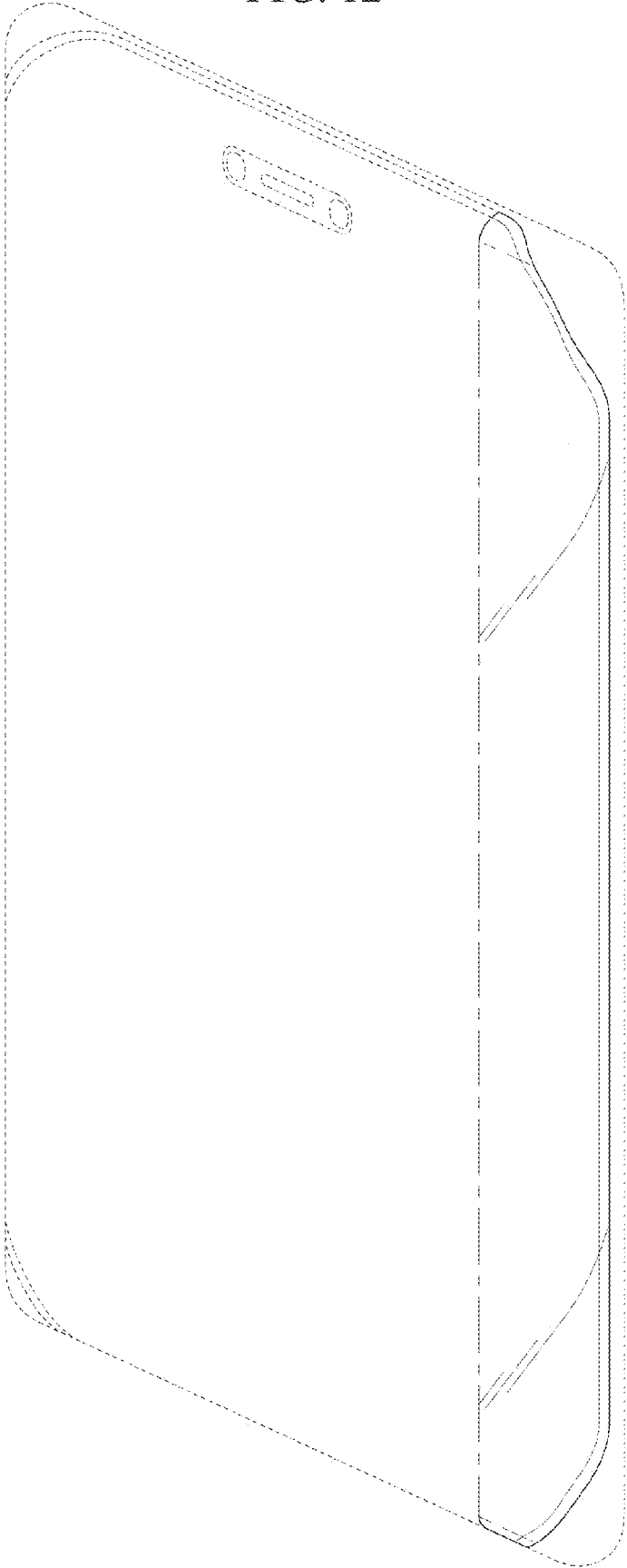

FIG. 13

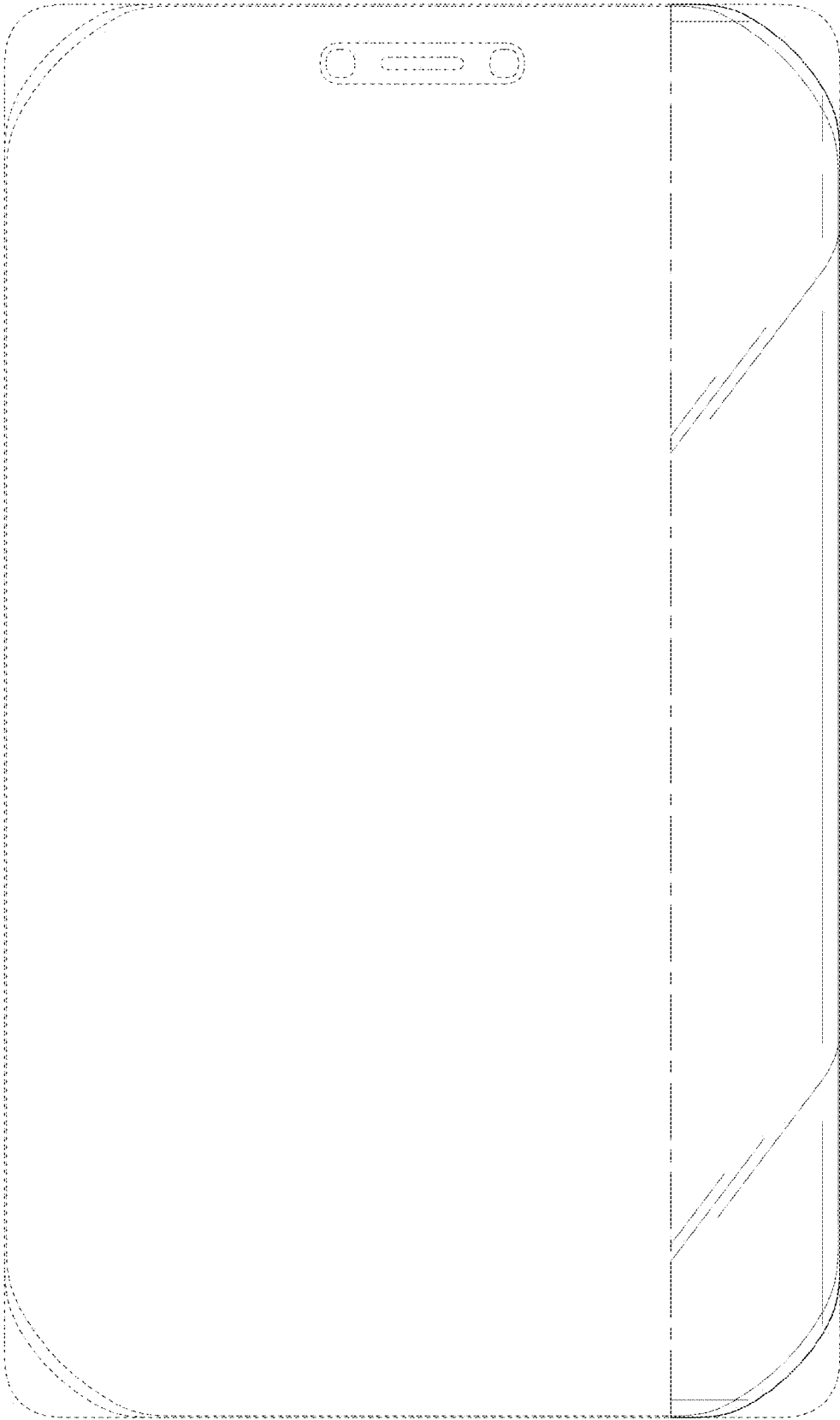

FIG. 14

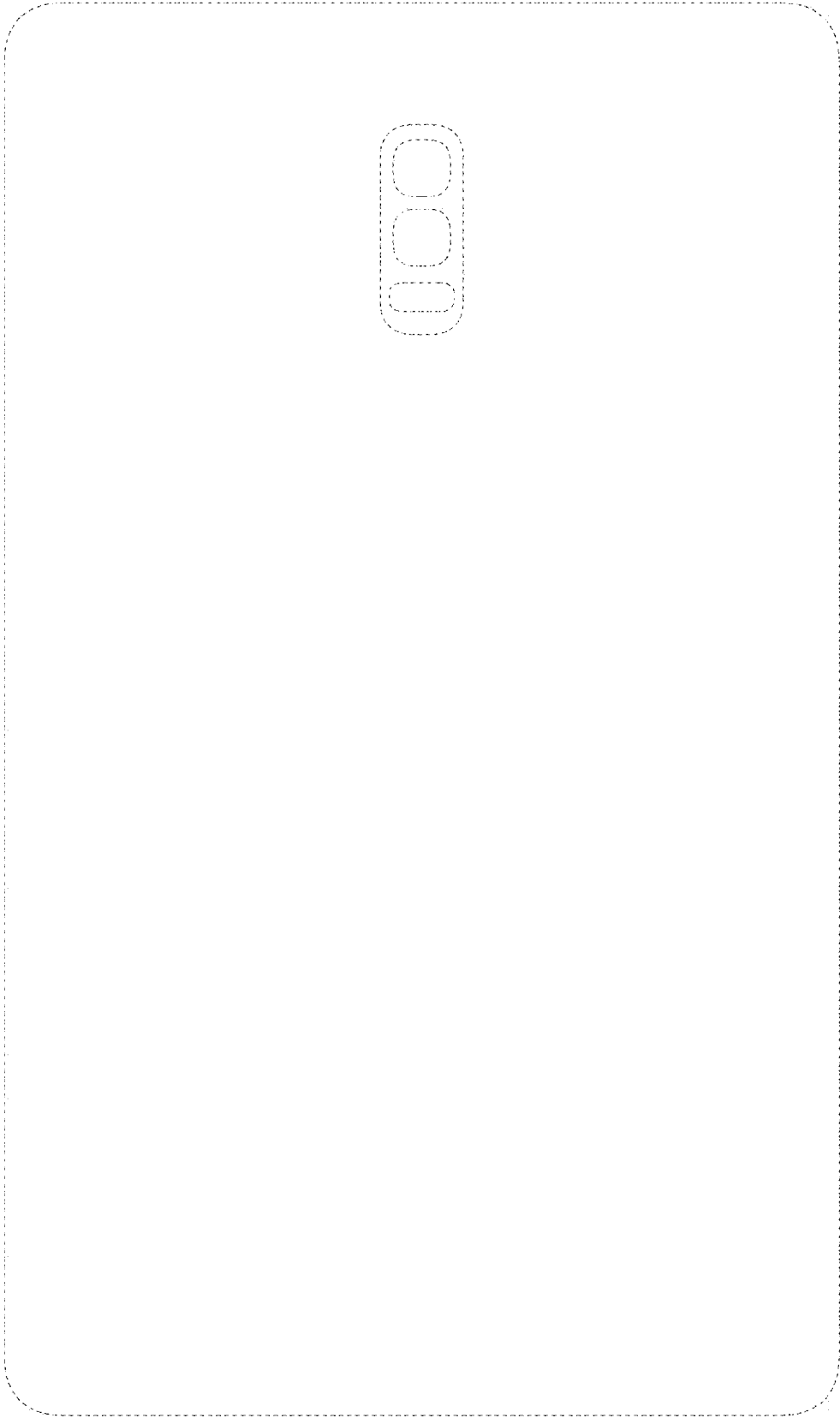

FIG. 15

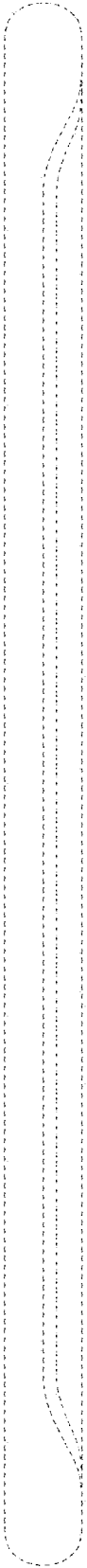

FIG. 16



FIG. 17

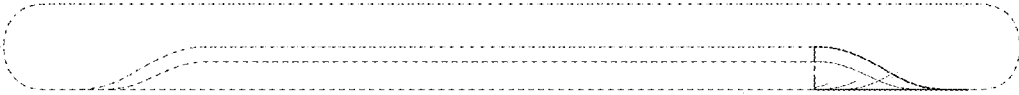

FIG. 18

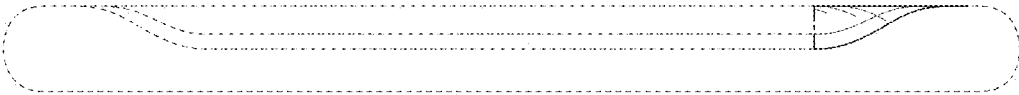

FIG. 19

