



US00D790145S

(12) **United States Design Patent**
Chen

(10) **Patent No.:** **US D790,145 S**

(45) **Date of Patent:** **** *Jun. 20, 2017**

(54) **TRASH CAN**

(56) **References Cited**

(71) Applicant: **EKO Development Limited,**
Guangzhou (CN)

U.S. PATENT DOCUMENTS

(72) Inventor: **Yizhi Chen,** Guangzhou (CN)

D488,902 S *	4/2004	Yang et al.	D34/8
D580,613 S *	11/2008	Yang et al.	D34/7
D615,722 S *	5/2010	Yang et al.	D34/7
D634,911 S *	3/2011	Yang et al.	D34/7
D657,108 S *	4/2012	Yang et al.	D34/7
D675,802 S *	2/2013	Yang et al.	D34/7
D675,803 S *	2/2013	Yang et al.	D34/7
D725,860 S *	3/2015	Spivey et al.	D34/7
D727,583 S *	4/2015	Yang et al.	D34/7

(73) Assignee: **EKO Development Limited,**
Guangzhou (CN)

(*) Notice: This patent is subject to a terminal disclaimer.

* cited by examiner

(**) Term: **14 Years**

Primary Examiner — Cynthia Ramirez

Assistant Examiner — Gino Colan

(21) Appl. No.: **29/501,992**

(74) *Attorney, Agent, or Firm* — William H. Dippert;

Laurence A. Greenberg; Werner H. Stemer

(22) Filed: **Sep. 10, 2014**

(57) **CLAIM**

The ornamental design for a trash can, as shown and described.

(30) **Foreign Application Priority Data**

Jun. 19, 2014 (CN) 2014 3 0191073

DESCRIPTION

(51) **LOC (10) Cl.** **09-09**

FIG. 1 is a top perspective view of a trash can showing my new design;

(52) **U.S. Cl.**

FIG. 2 is a front view of a trash can of FIG. 1;

USPC **D34/7**

FIG. 3 is a rear view of a trash can of FIG. 1;

(58) **Field of Classification Search**

USPC D34/1-11; 220/908-913, 262-264

FIG. 4 is a left view of a trash can of FIG. 1;

CPC .. B65F 1/1638; B65F 1/02; B65F 7/00; B65F

FIG. 5 is a right view of a trash can of FIG. 1; and,

1/1615

FIG. 6 is a top view of a trash can of FIG. 1.

See application file for complete search history.

1 Claim, 6 Drawing Sheets

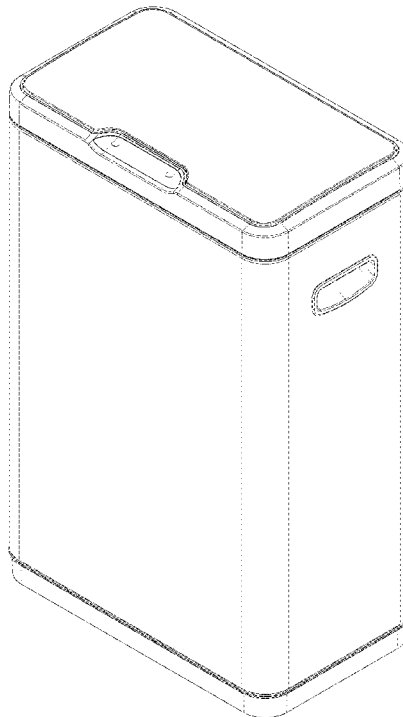

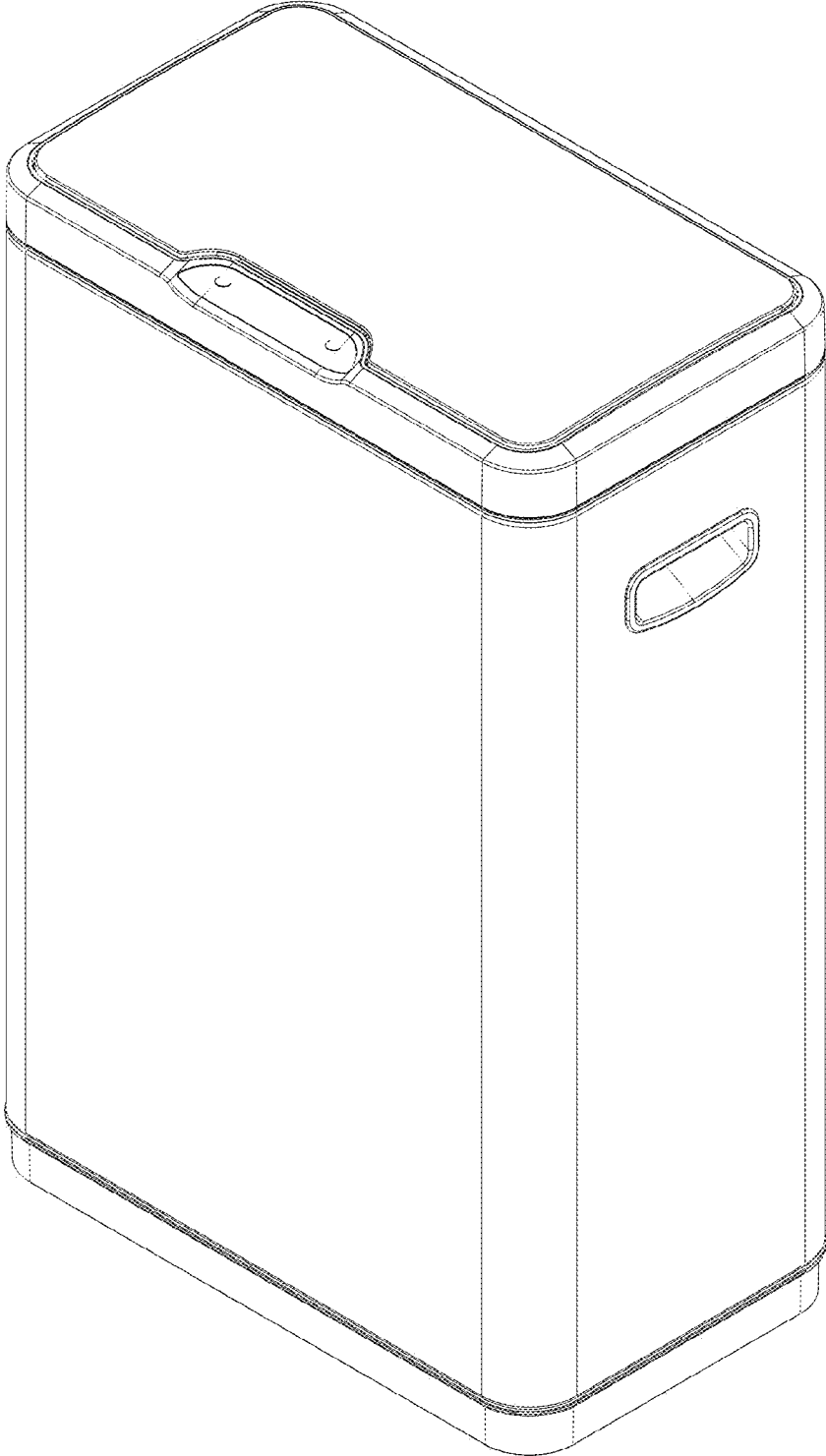

FIG. 1

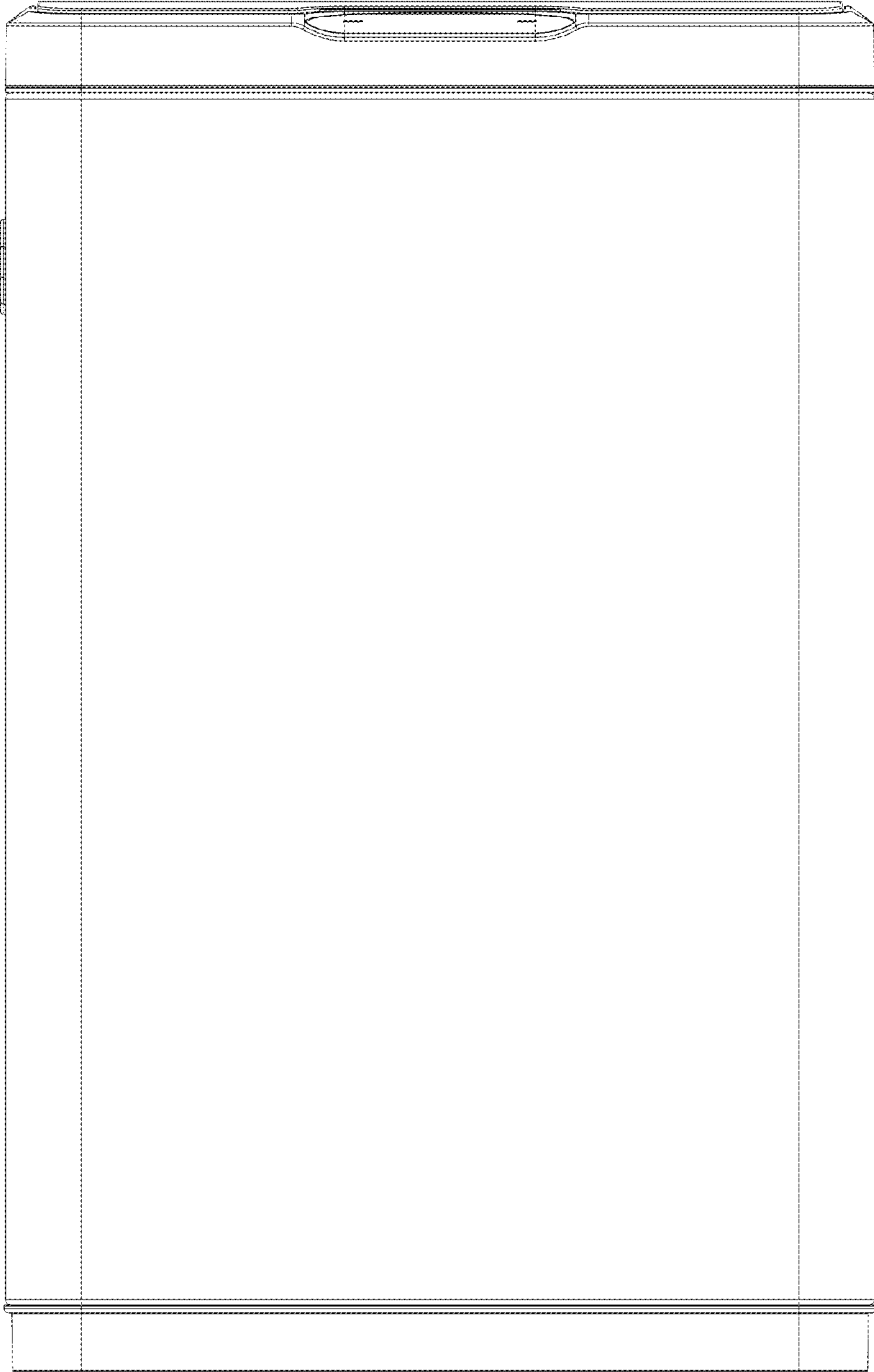

FIG. 2

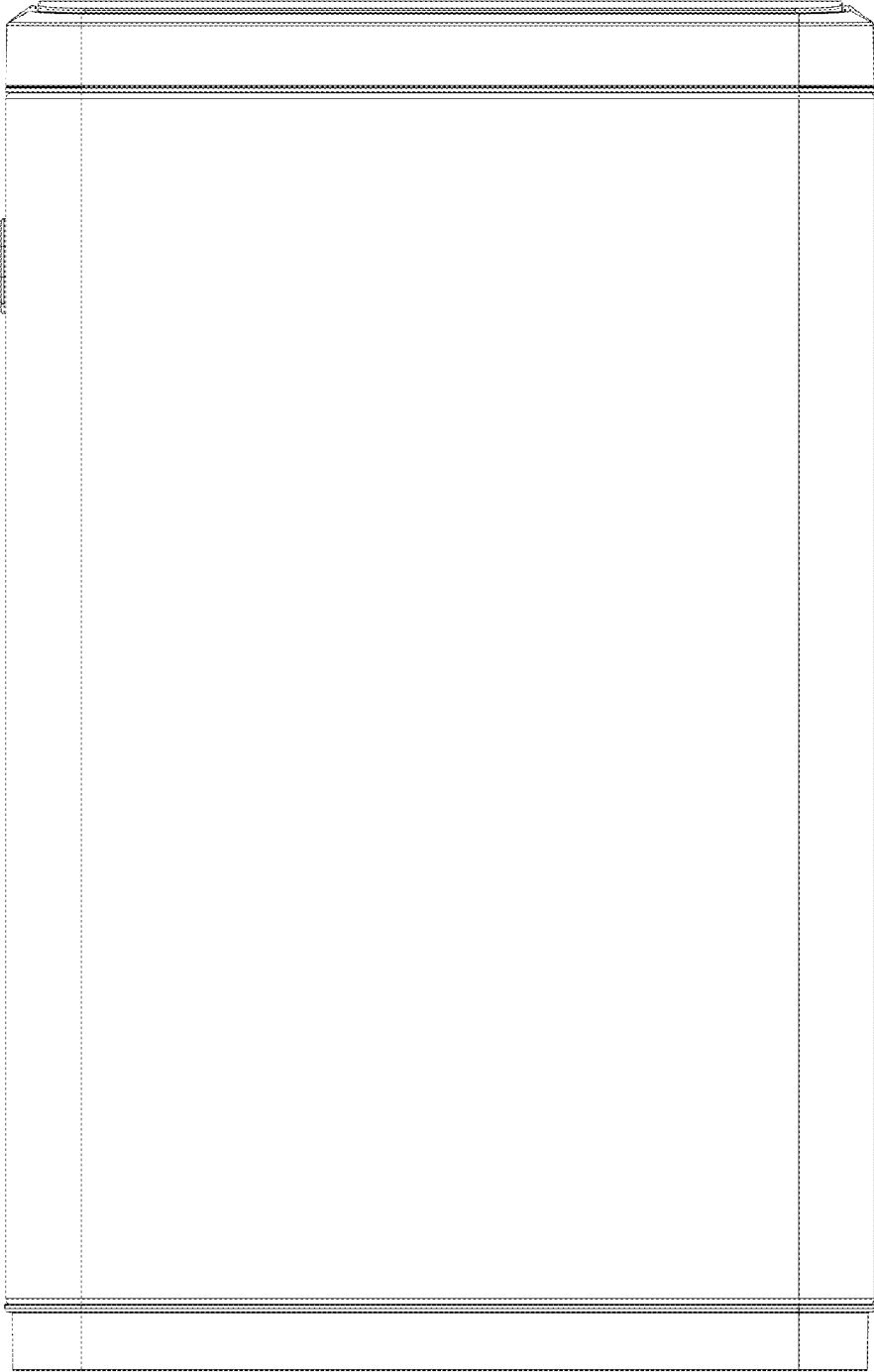

FIG. 3

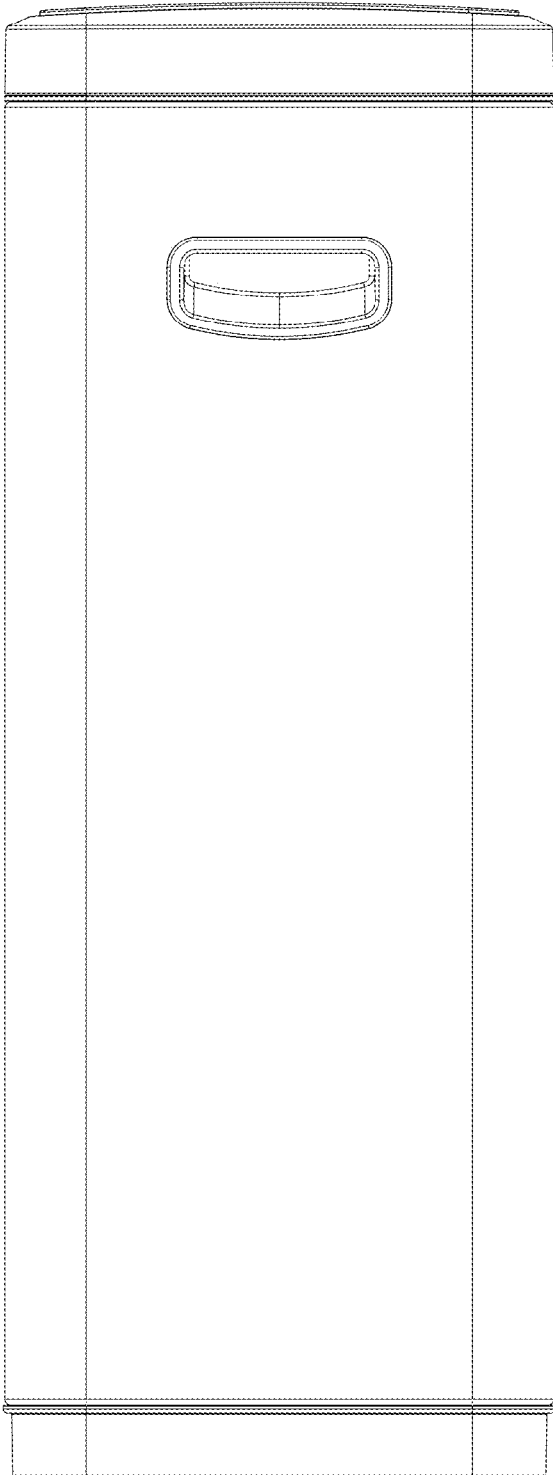

FIG. 4

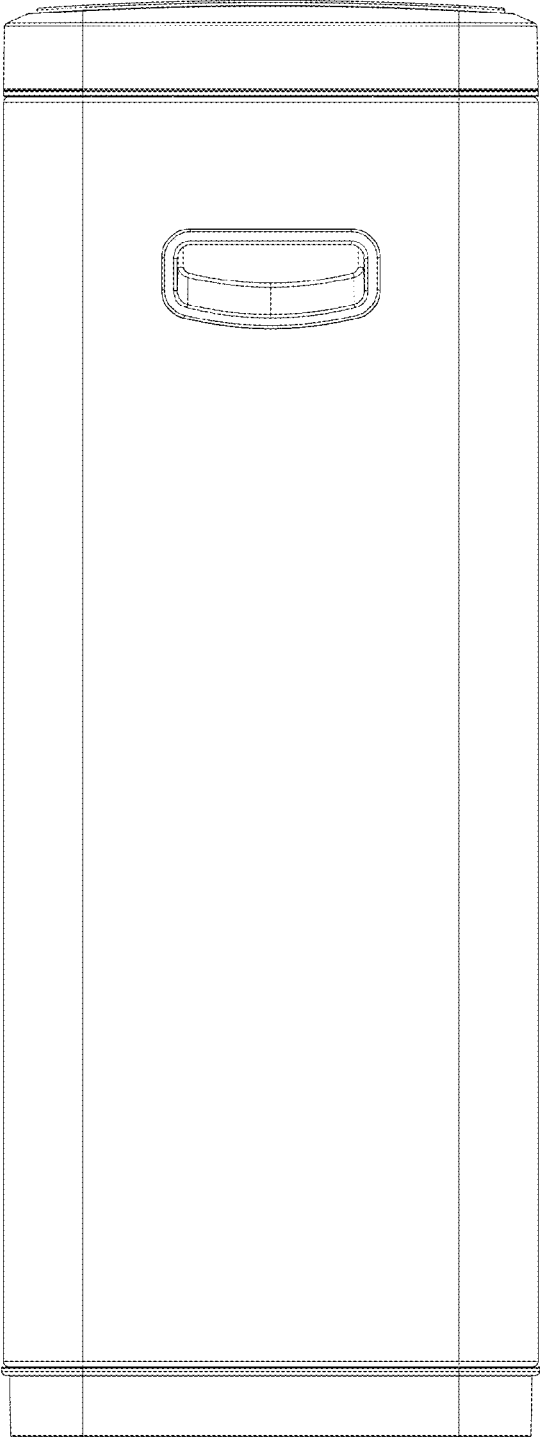

FIG. 5

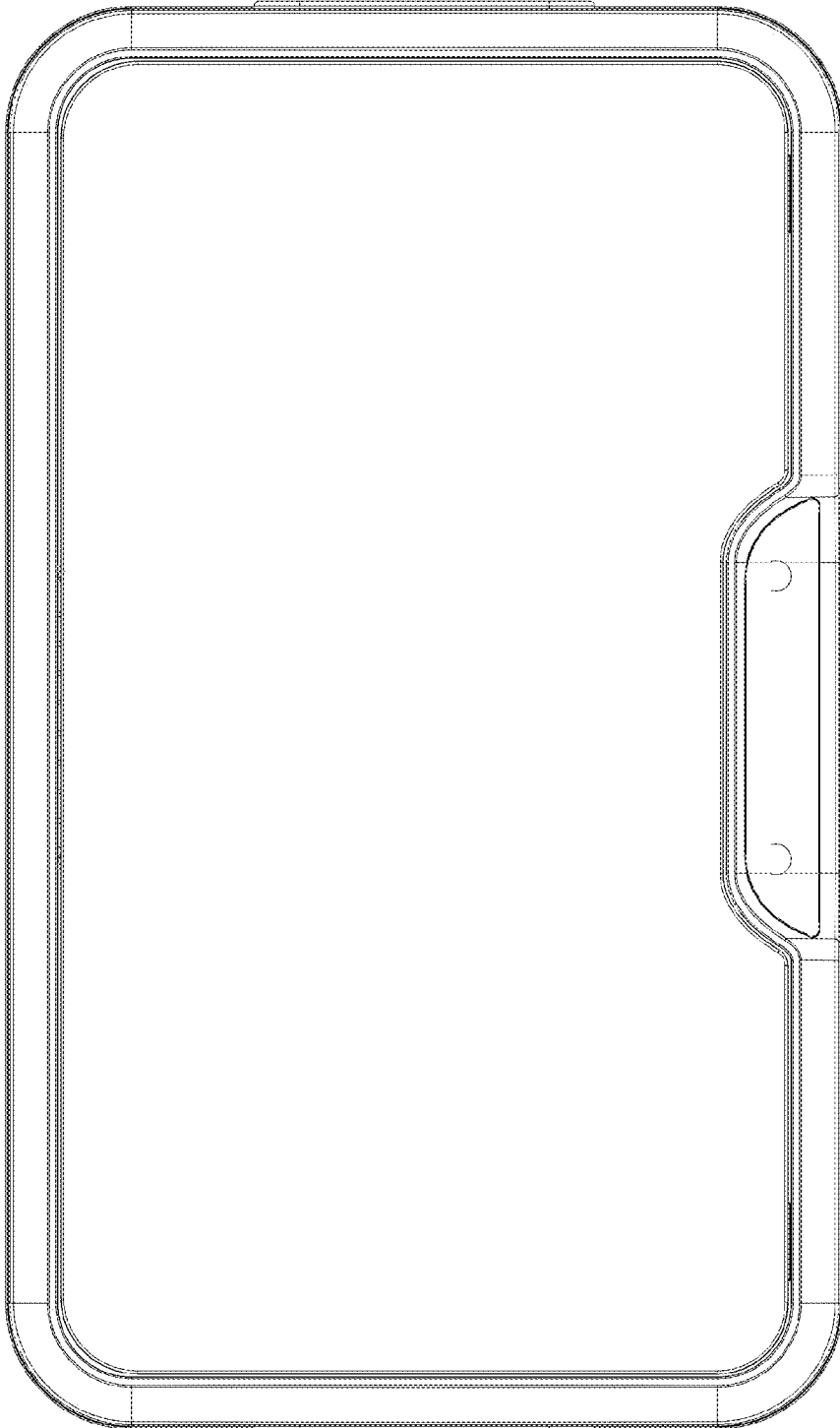

FIG. 6