



US00D563127S

(12) **United States Design Patent**  
**Henry et al.**

(10) **Patent No.:** **US D563,127 S**

(45) **Date of Patent:** **\*\* Mar. 4, 2008**

(54) **GRAVITY FED DISPENSER**

(75) Inventors: **Eric Henry**, East Rutherford, NJ (US);  
**Craig Hockenbury**, Union, NJ (US);  
**Margaret Kime**, Baltimore, MD (US);  
**James E. Brennan**, Phoenix, MD (US)

(73) Assignee: **McCormick & Company, Inc.**, Sparks, MD (US)

(\*\*) Term: **14 Years**

(21) Appl. No.: **29/277,680**

(22) Filed: **Mar. 6, 2007**

(51) **LOC (8) Cl.** ..... **20-02**

(52) **U.S. Cl.** ..... **D6/515**

(58) **Field of Classification Search** ..... D6/515,  
D6/517; D7/705-708; 211/85.5, 59.2, 47;  
206/139; 221/282-284; 222/173

See application file for complete search history.

(56) **References Cited**

**U.S. PATENT DOCUMENTS**

2,852,327	A *	9/1958	Mason	.....	211/59.2
4,228,903	A *	10/1980	Eckert	.....	211/59.2
4,356,923	A *	11/1982	Young et al.	.....	211/59.2
D342,420	S *	12/1993	Ienna	.....	D6/517
D380,113	S *	6/1997	Byrd	.....	D6/515
D381,849	S *	8/1997	Snyder	.....	D6/515
5,788,117	A *	8/1998	Zimmanck	.....	211/59.2
D402,837	S *	12/1998	Boire et al.	.....	D6/515
D499,914	S *	12/2004	Rimback	.....	D6/515

\* cited by examiner

*Primary Examiner*—Brian N Vinson

(74) *Attorney, Agent, or Firm*—Oblon, Spivak, McClelland, Maier & Neustadt, P.C.

(57) **CLAIM**

The ornamental design for a gravity fed dispenser, or the like, as shown and described.

**DESCRIPTION**

FIG. 1 is a front elevational view of a gravity fed dispenser or the like, showing our new design;

FIG. 2 is a rear elevational view thereof;

FIG. 3 is a left side elevational view thereof;

FIG. 4 is a right side elevational view thereof;

FIG. 5 is a top plan view thereof;

FIG. 6 is a bottom plan view thereof;

FIG. 7 is a top and right front perspective view thereof;

FIG. 8 is a front elevational view of second embodiment of the gravity fed dispenser;

FIG. 9 is a rear elevational view thereof;

FIG. 10 is a left side elevational view thereof;

FIG. 11 is a right side elevational view thereof;

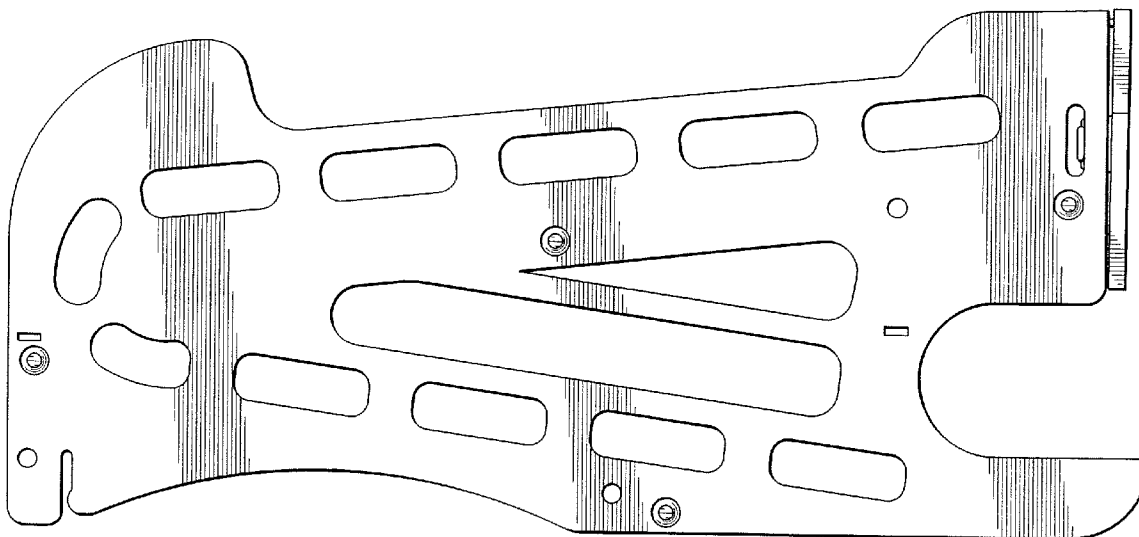
FIG. 12 is a top plan view thereof;

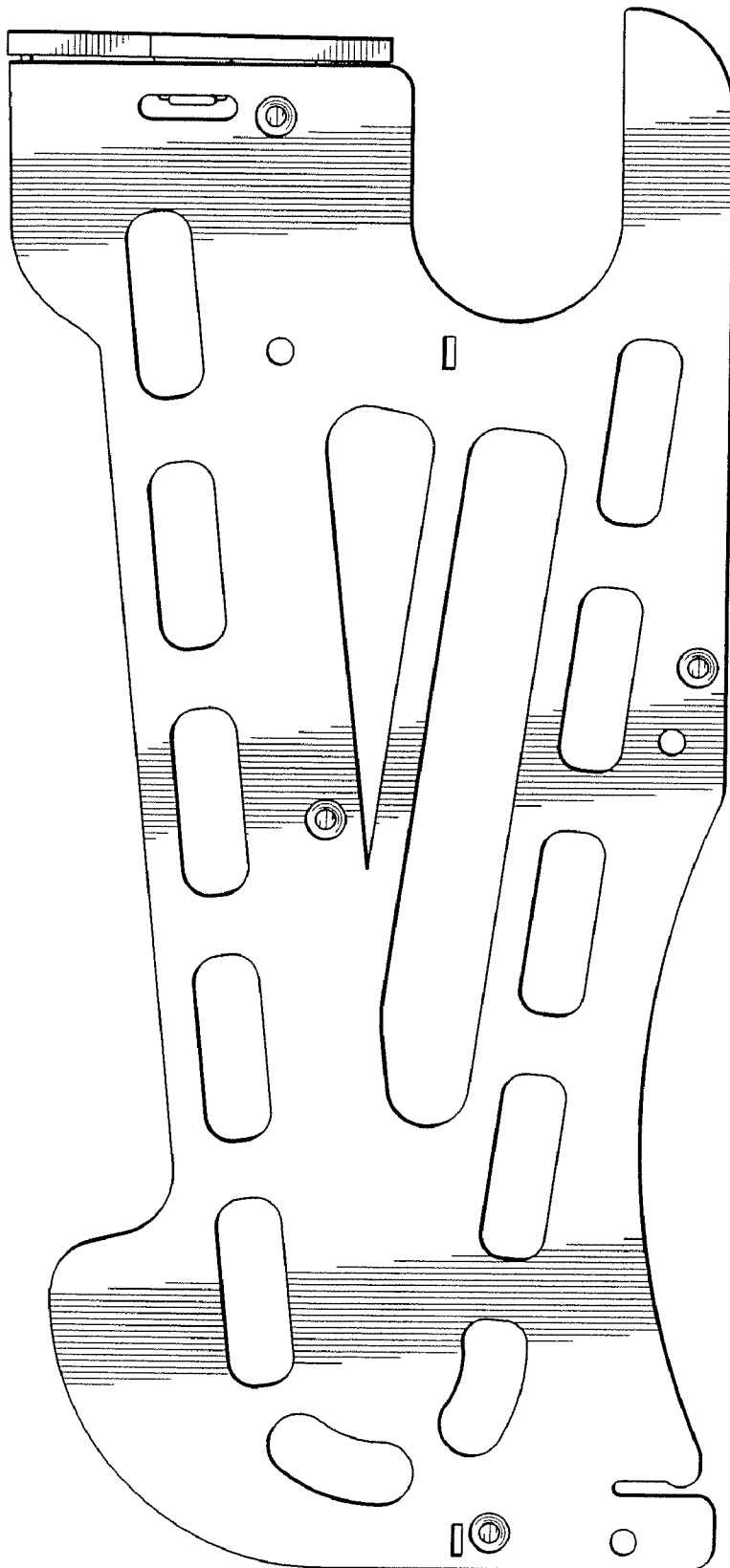
FIG. 13 is a bottom plan view thereof; and,

FIG. 14 is a top and right front side perspective view thereof.

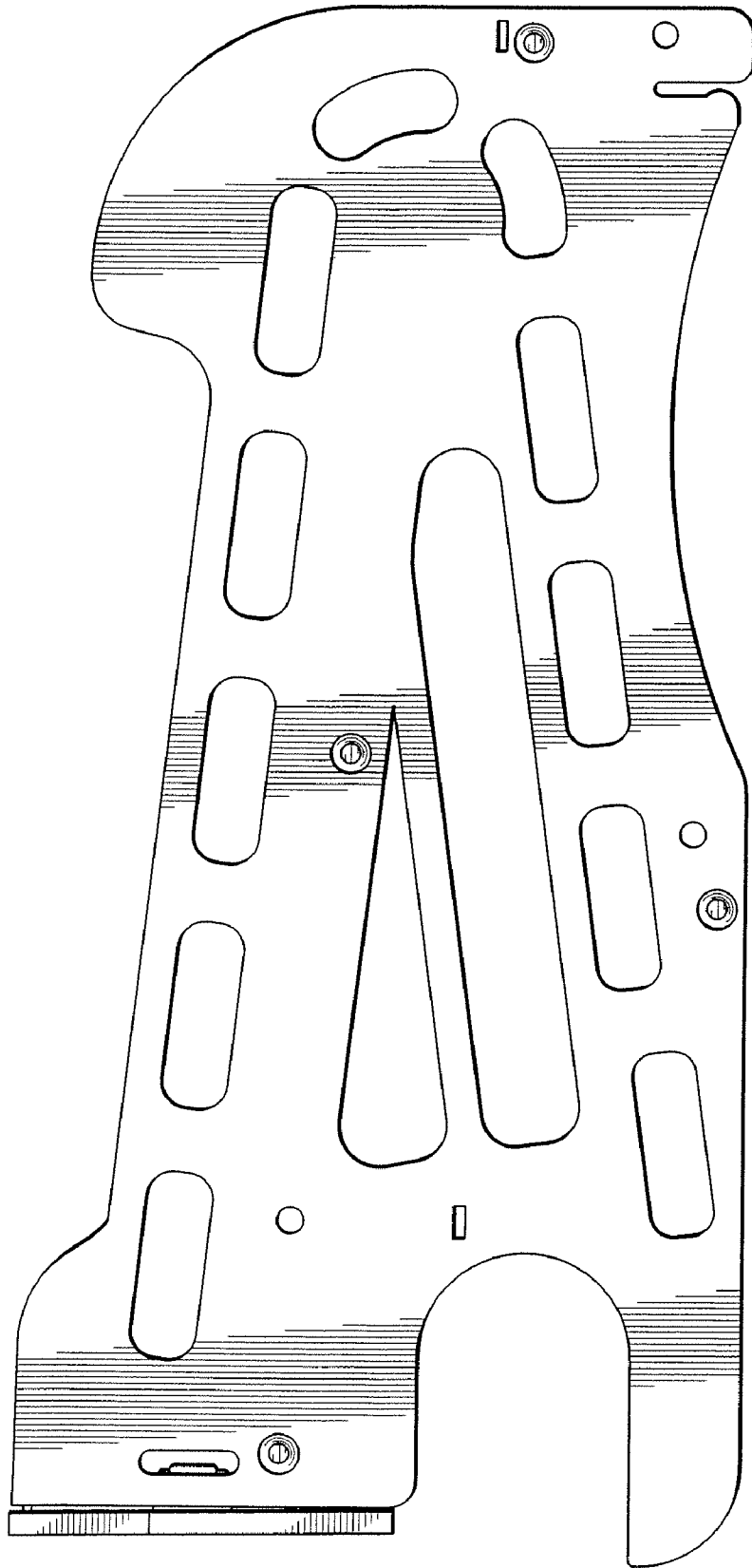
The broken line showing in the figures is for illustrative purposes only and forms no part of the claimed design.

**1 Claim, 12 Drawing Sheets**

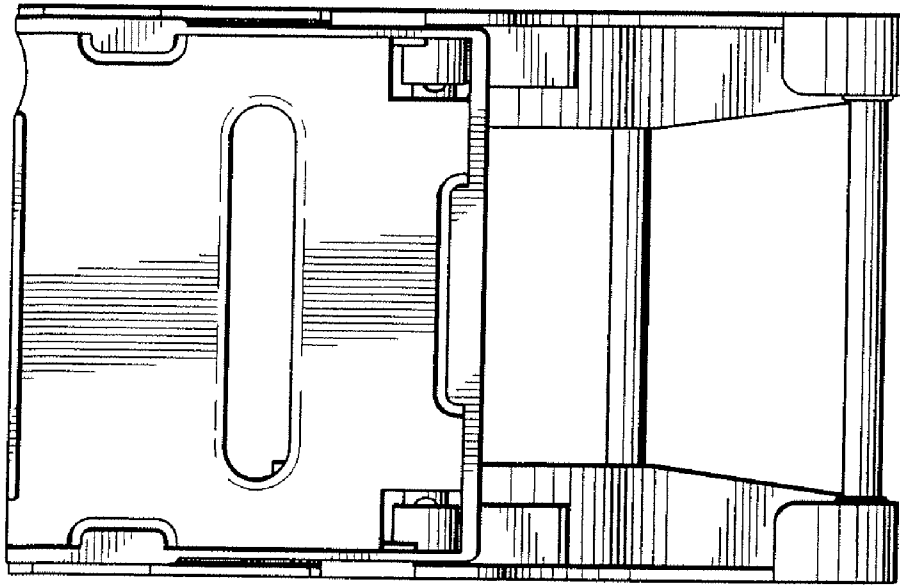




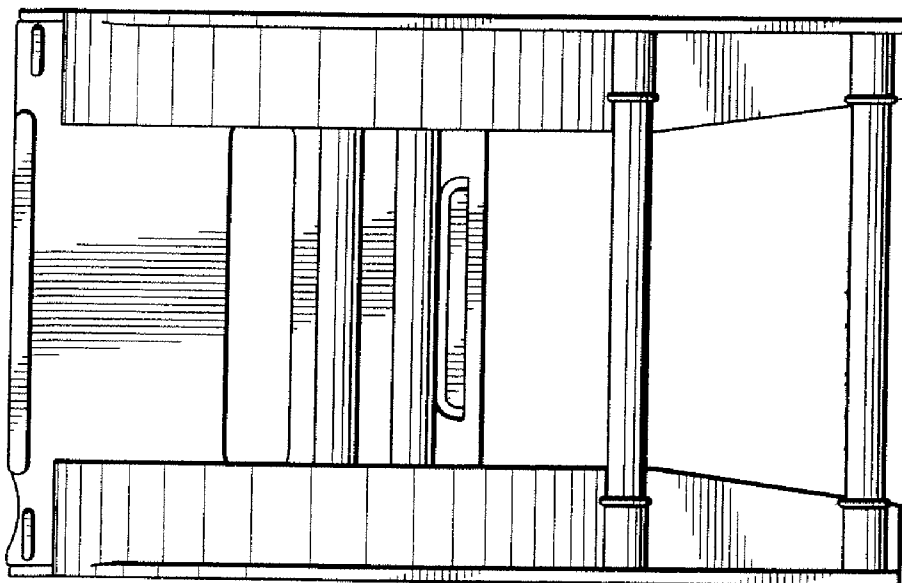
*Fig. 1*



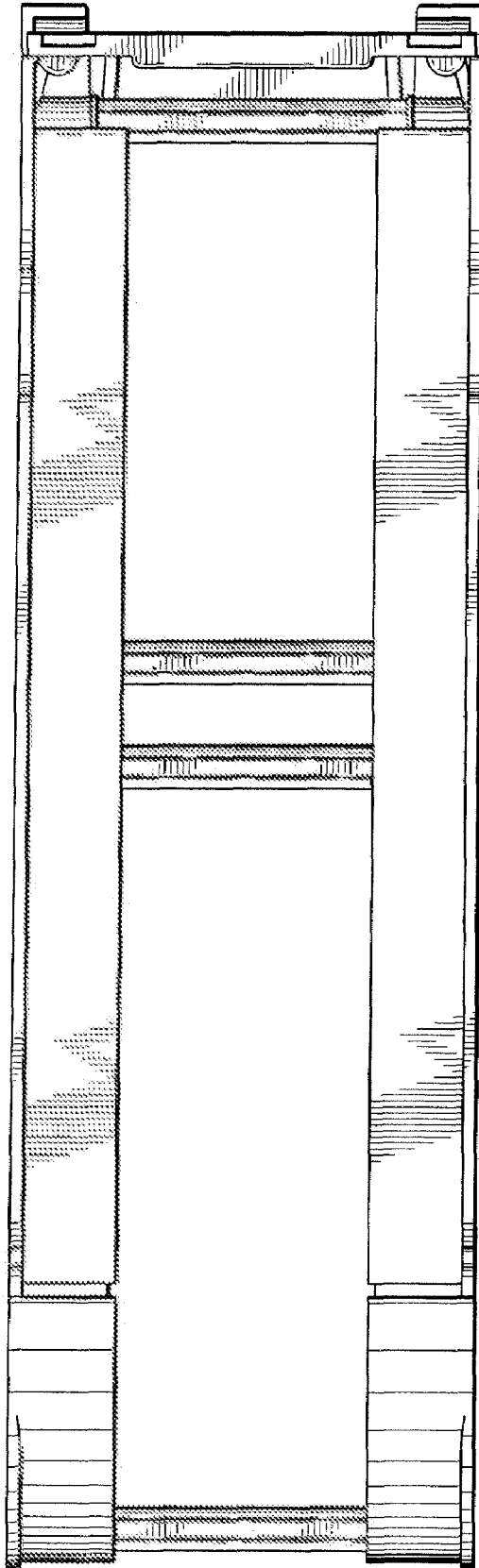
*Fig. 2*



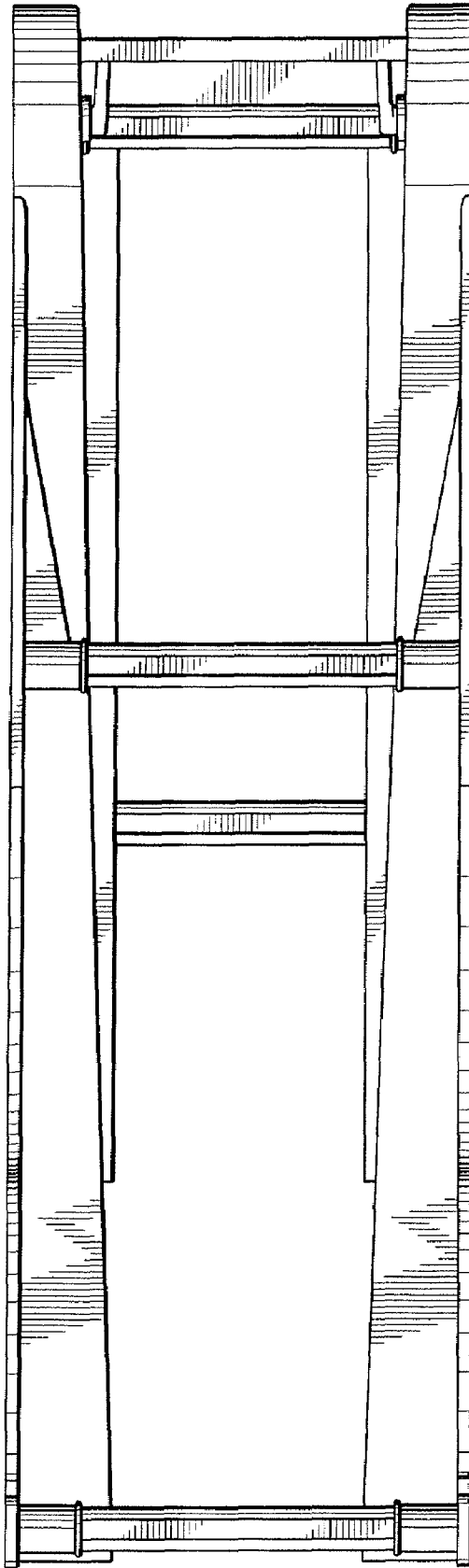
*Fig. 4*



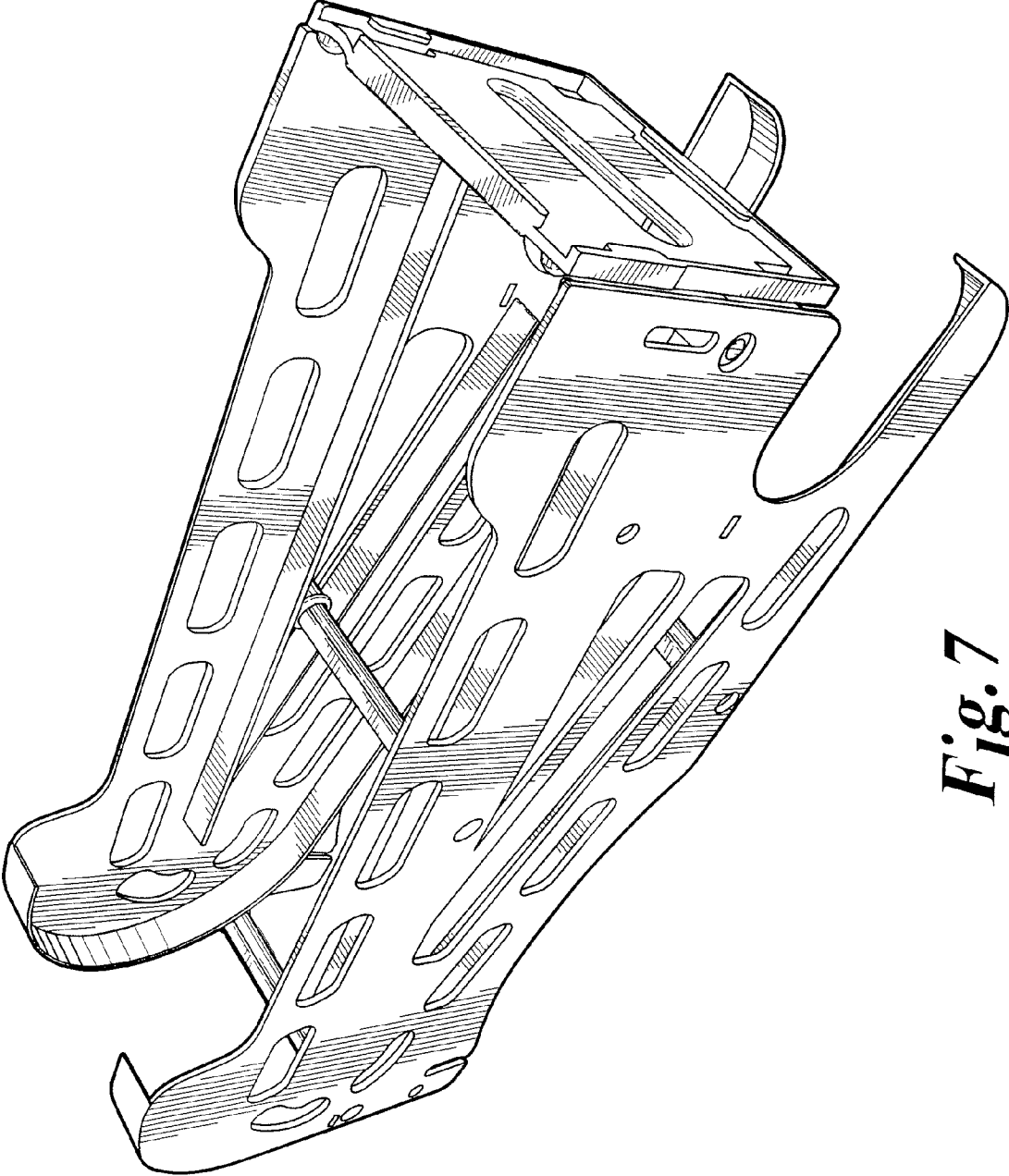
*Fig. 3*



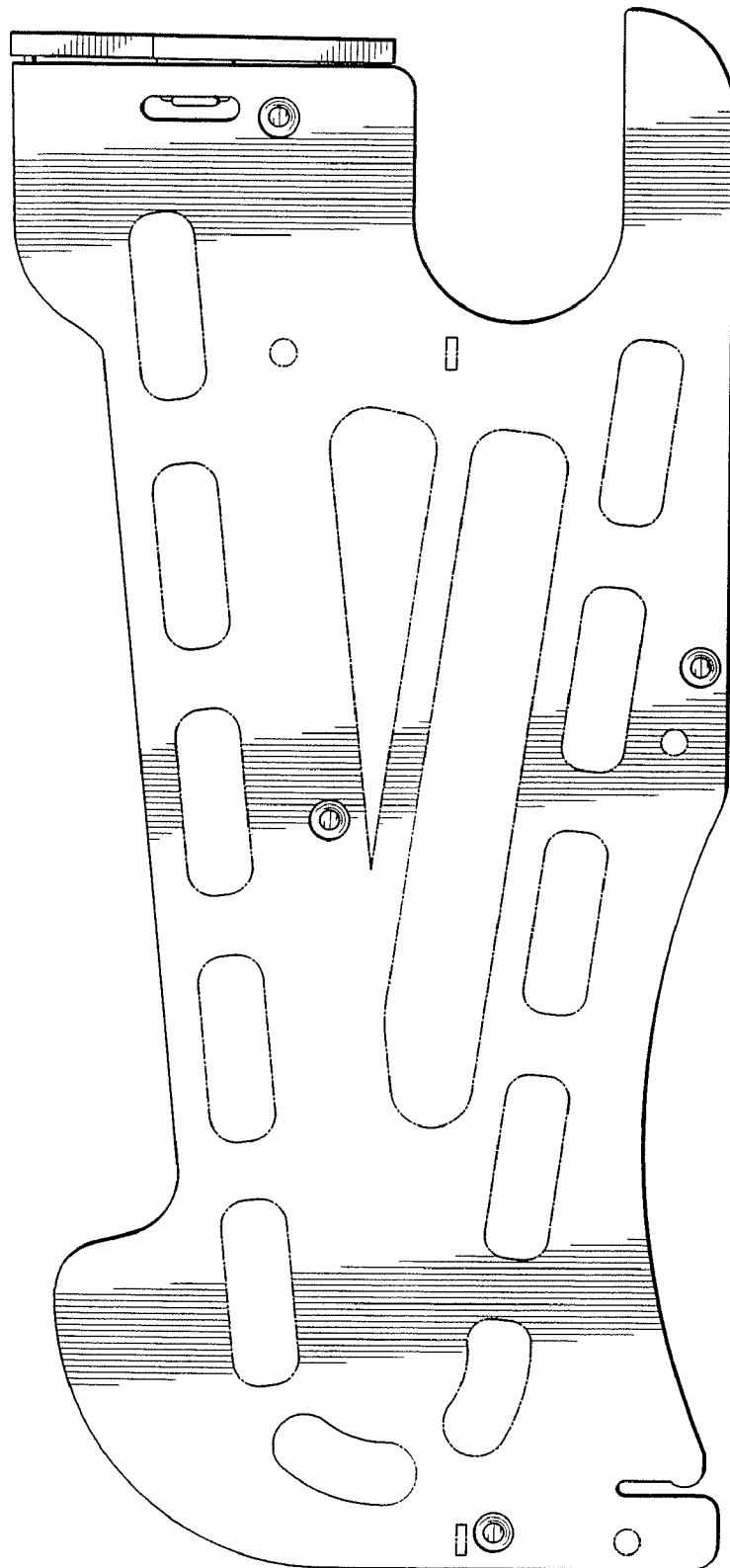
*Fig. 5*



*Fig. 6*

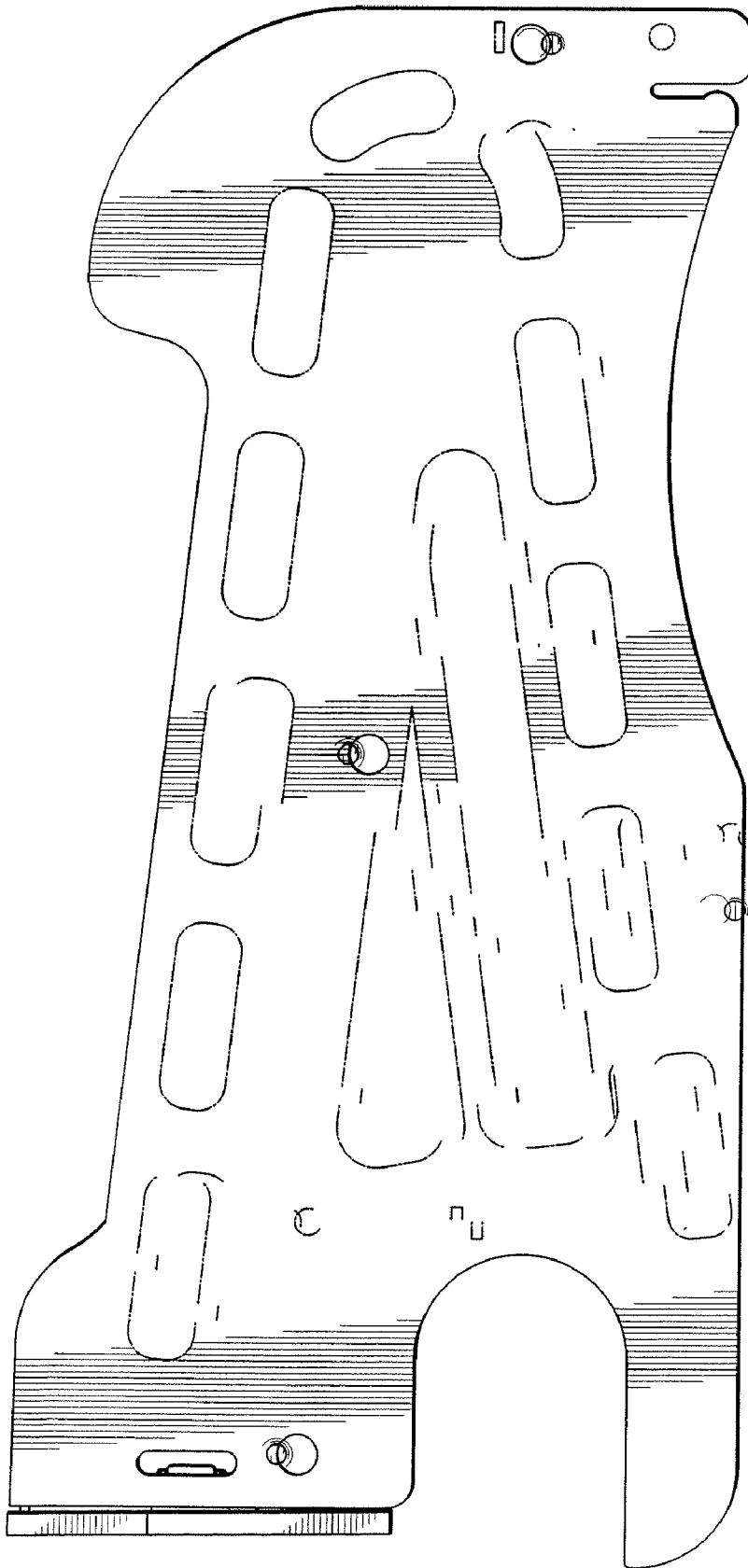


**Fig. 7**

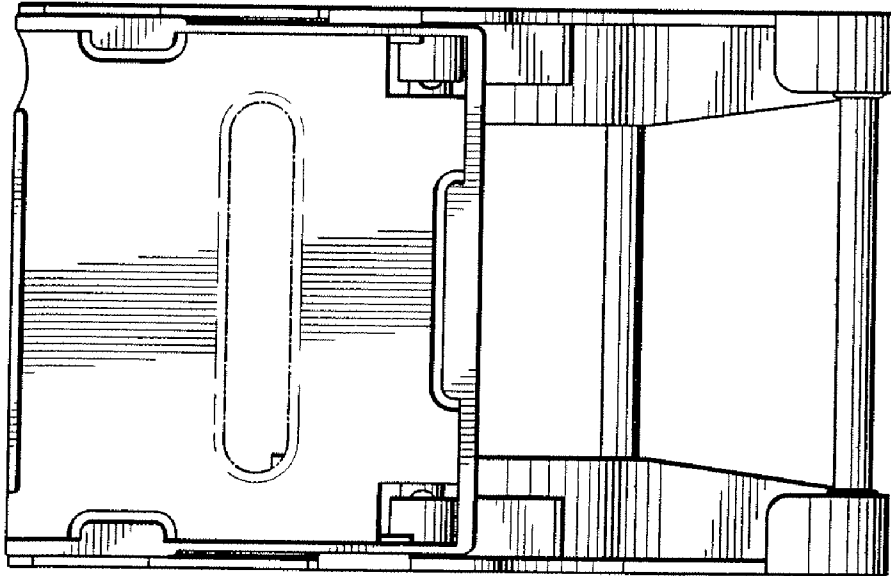


*Fig. 8*

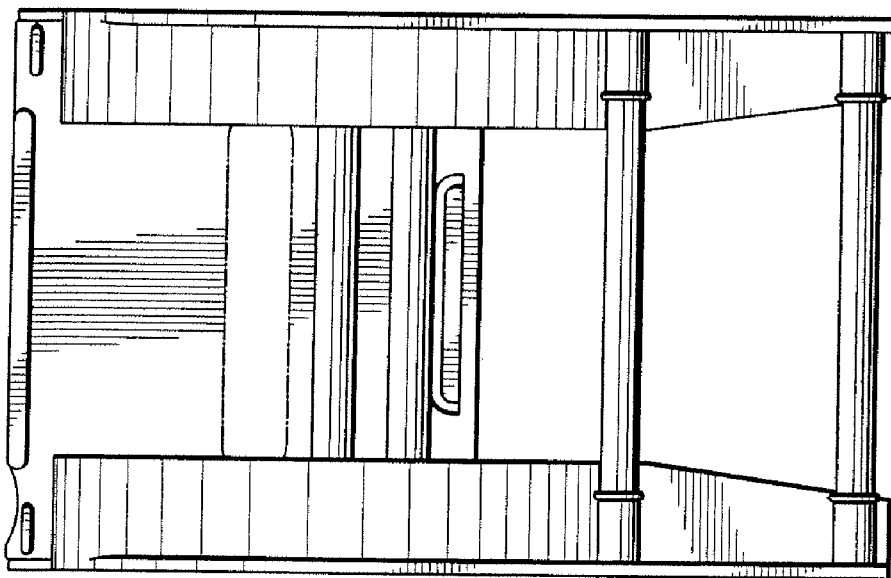




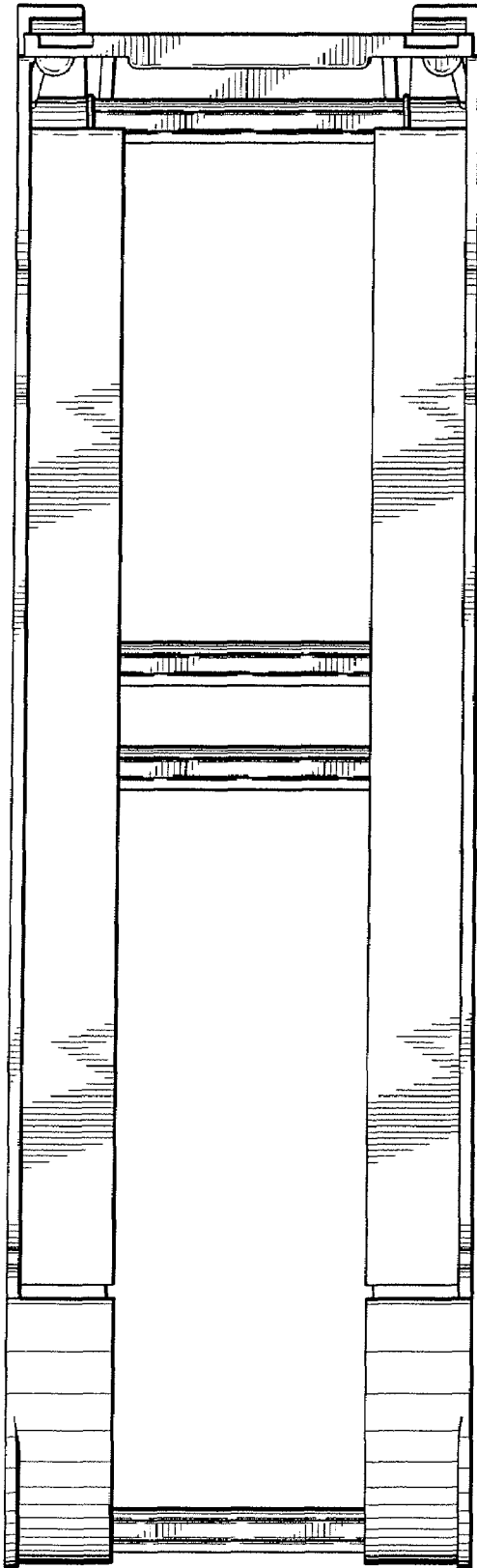
*Fig. 9*



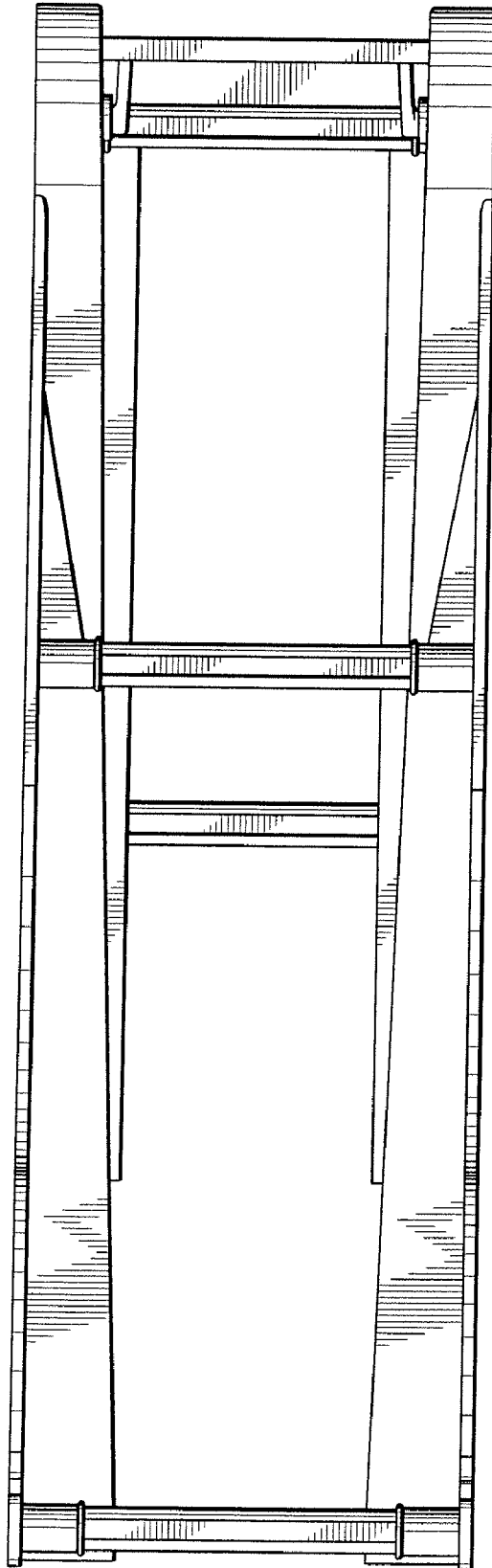
*Fig. 11*



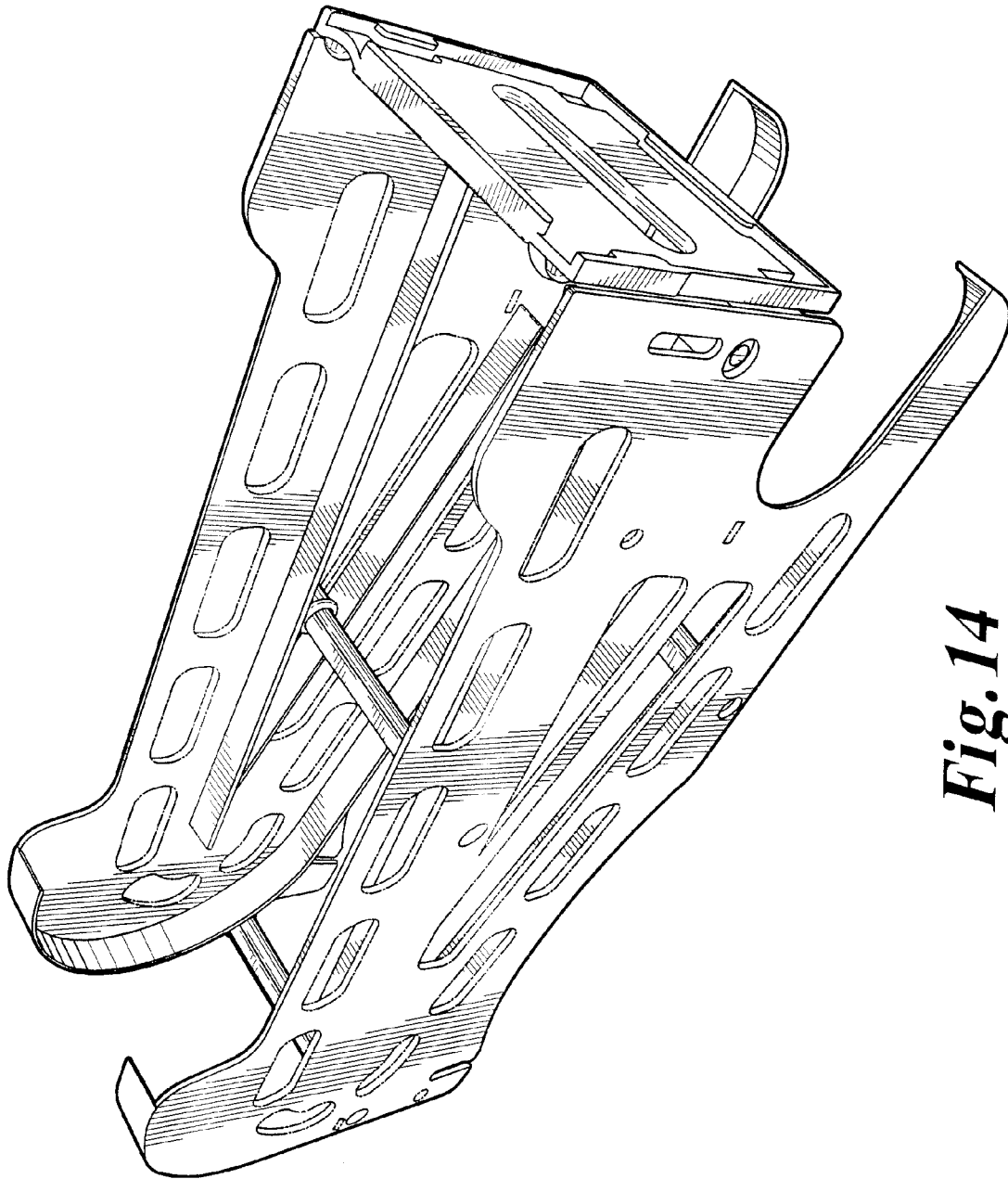
*Fig. 10*



*Fig. 12*



*Fig. 13*



**Fig. 14**