



US00D583551S

(12) **United States Design Patent**
Stulman

(10) **Patent No.:** **US D583,551 S**

(45) **Date of Patent:** **** Dec. 30, 2008**

(54) **BAG**

(75) Inventor: **Nicole Stulman**, Paris (FR)

(73) Assignee: **Hermes Sellier**, Paris (FR)

(**) Term: **14 Years**

(21) Appl. No.: **29/295,610**

(22) Filed: **Oct. 2, 2007**

(30) **Foreign Application Priority Data**

Apr. 3, 2007 (EM) 000700869-0001

(51) **LOC (8) Cl.** **03-01**

(52) **U.S. Cl.** **D3/232**

(58) **Field of Classification Search** D3/232-234,
D3/240-246, 318, 322, 324; 150/100, 103-104,
150/107-110, 114, 118-119
See application file for complete search history.

(56) **References Cited**

U.S. PATENT DOCUMENTS

1,562,408 A * 11/1925 Berkowitz 150/103

D99,436 S * 4/1936 Hawes D3/246
D165,492 S * 12/1951 Stakofsky D3/246
D379,869 S * 6/1997 Formby D3/243
D493,615 S * 8/2004 Peng D3/246

* cited by examiner

Primary Examiner—Holly H Baynham

(74) *Attorney, Agent, or Firm*—Foley & Lardner LLP

(57) **CLAIM**

The ornamental design for a bag, as shown and described.

DESCRIPTION

FIG. 1 is a front perspective view of a bag showing my new design;

FIG. 2 is a front elevation view thereof;

FIG. 3 is a top plan view thereof;

FIG. 4 is a left side elevation view thereof;

FIG. 5 is a right side elevation view thereof;

FIG. 6 is a bottom plan view thereof; and,

FIG. 7 is a rear elevation view thereof.

1 Claim, 3 Drawing Sheets

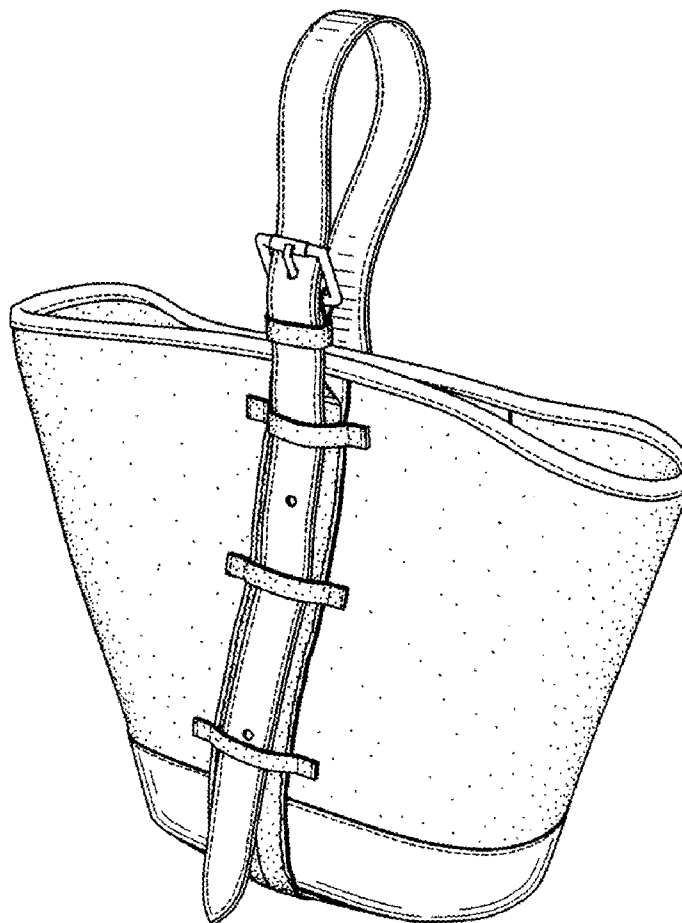

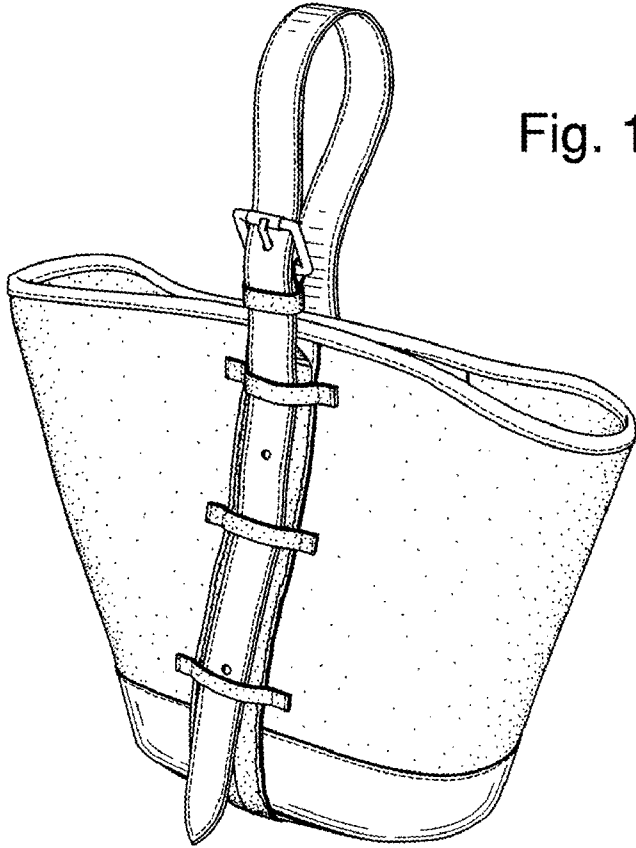

Fig. 1

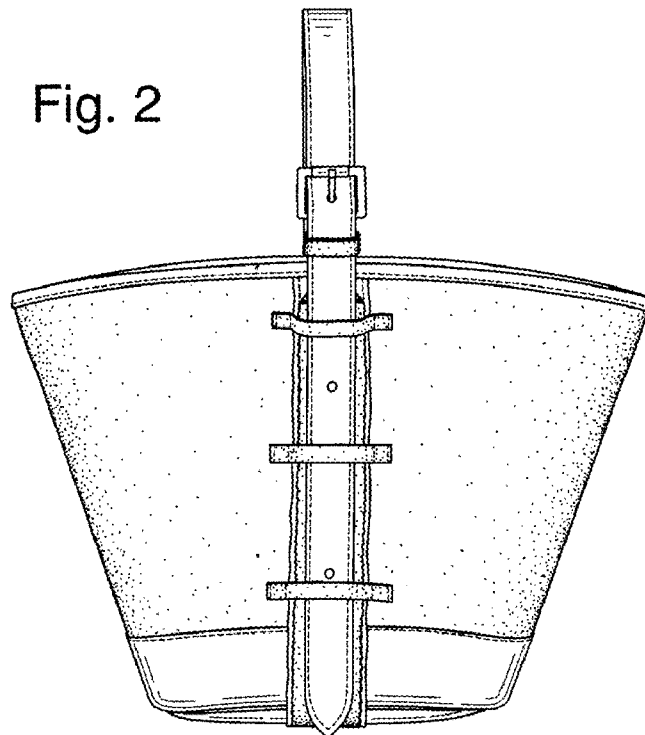

Fig. 2

Fig. 3

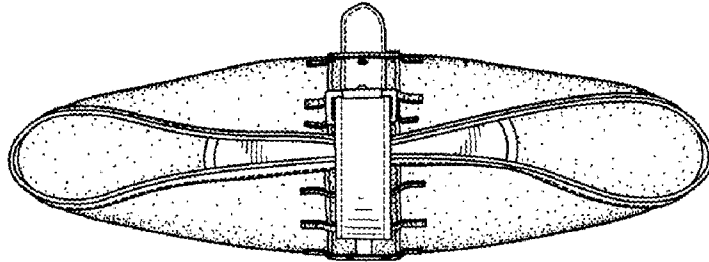

Fig. 4

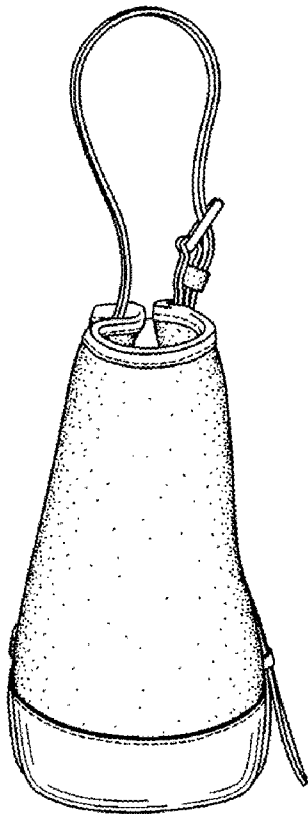

Fig. 5

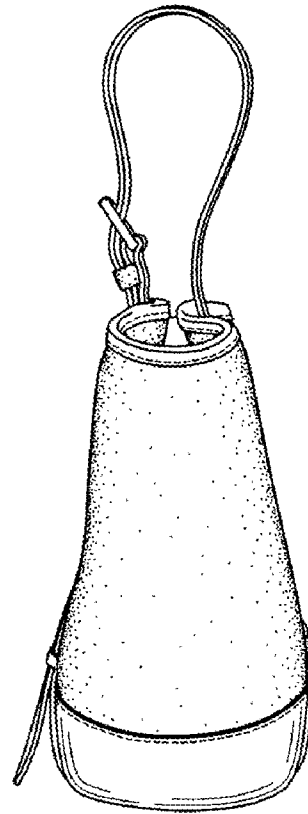

Fig. 6

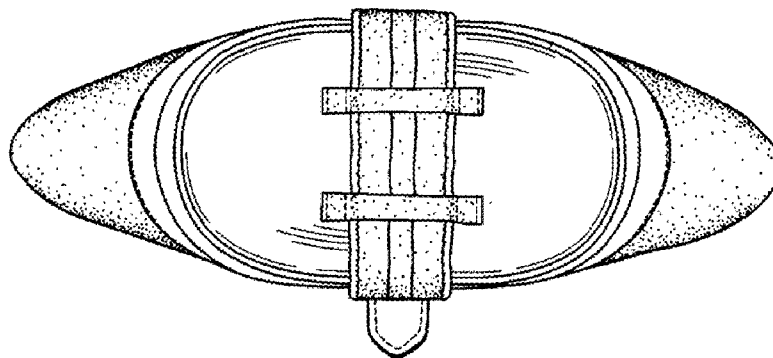

Fig. 7

