



US00D558791S

(12) **United States Design Patent**  
**Toh et al.**

(10) **Patent No.:** **US D558,791 S**  
(45) **Date of Patent:** **\*\* Jan. 1, 2008**

(54) **MEDIA PLAYER**

(75) Inventors: **Boon Keat Eddy Toh**, Singapore (SG);  
**Nicholas Stephen Marchand**,  
Singapore (SG); **Ka-Wei Adrian Wong**,  
Singapore (SG); **Kok Chong Anthony**  
**Oh**, Singapore (SG)

(73) Assignee: **Creative Technology Ltd**, Singapore  
(SG)

(\*\*) Term: **14 Years**

(21) Appl. No.: **29/275,677**

(22) Filed: **Jan. 3, 2007**

(51) **LOC (8) Cl.** ..... **14-03**

(52) **U.S. Cl.** ..... **D14/496**

(58) **Field of Classification Search** ..... D14/496,  
D14/401, 435, 474, 483, 217, 137, 138, 160,  
D14/168; 345/156, 169, 173-179, 905; 715/727-729,  
715/864; 455/11.1, 773, 344-347, 93, 95;  
370/342-344; 369/1, 2, 6, 12; 463/43-47;  
273/148 B

See application file for complete search history.

(56) **References Cited**

**U.S. PATENT DOCUMENTS**

5,556,106	A	*	9/1996	Jurcisin	.....	473/431
5,563,400	A	*	10/1996	Le Roux	.....	235/486
6,238,291	B1	*	5/2001	Fujimoto et al.	.....	463/44
6,671,567	B1	*	12/2003	Dwyer et al.	.....	700/94
D489,731	S	*	5/2004	Huang	.....	D14/496
D492,323	S	*	6/2004	Wang	.....	D14/496

D499,423	S	*	12/2004	Bahroocha et al.	.....	D14/496
D511,528	S	*	11/2005	Yang	.....	D14/496
D523,445	S	*	6/2006	Toh	.....	D14/496

\* cited by examiner

*Primary Examiner*—Prabhakar Deshmukh  
(74) *Attorney, Agent, or Firm*—P. Francois de Villiers

(57) **CLAIM**

The ornamental design for a media player, substantially as shown and described.

**DESCRIPTION**

FIG. 1 is a perspective view of a media player showing our new design.

FIG. 2 is a front view of the media player shown in FIG. 1;

FIG. 3 is a rear view of the media player shown in FIG. 1;

FIG. 4 is a left side view of the media player shown in FIG. 1;

FIG. 5 is a right side view of the media player shown in FIG. 1;

FIG. 6 is a top view of the media player shown in FIG. 1;

FIG. 7 is a bottom view of the media player shown in FIG. 1; and,

FIG. 8 is a perspective back view of the media player shown in FIG. 1.

Features illustrated in phantom using dashed lines (broken lines) are shown for exemplary purposes only and form no part of the claimed design.

**1 Claim, 5 Drawing Sheets**

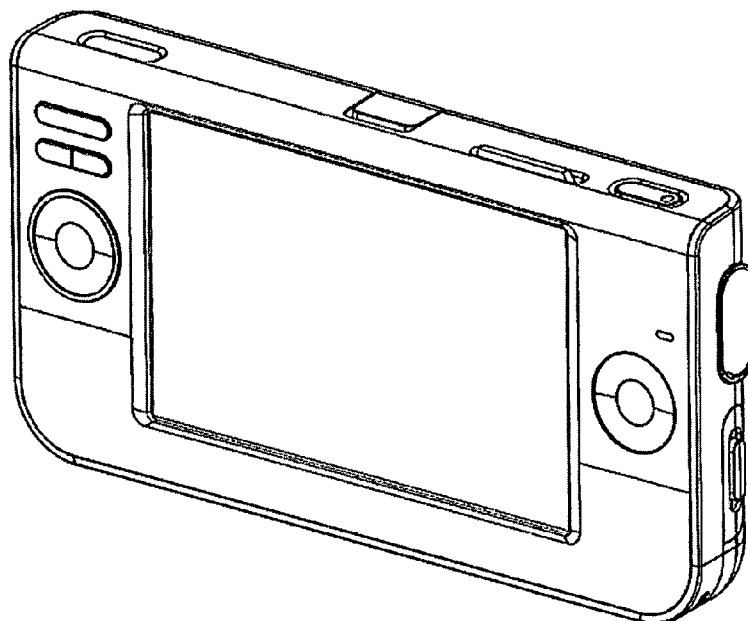

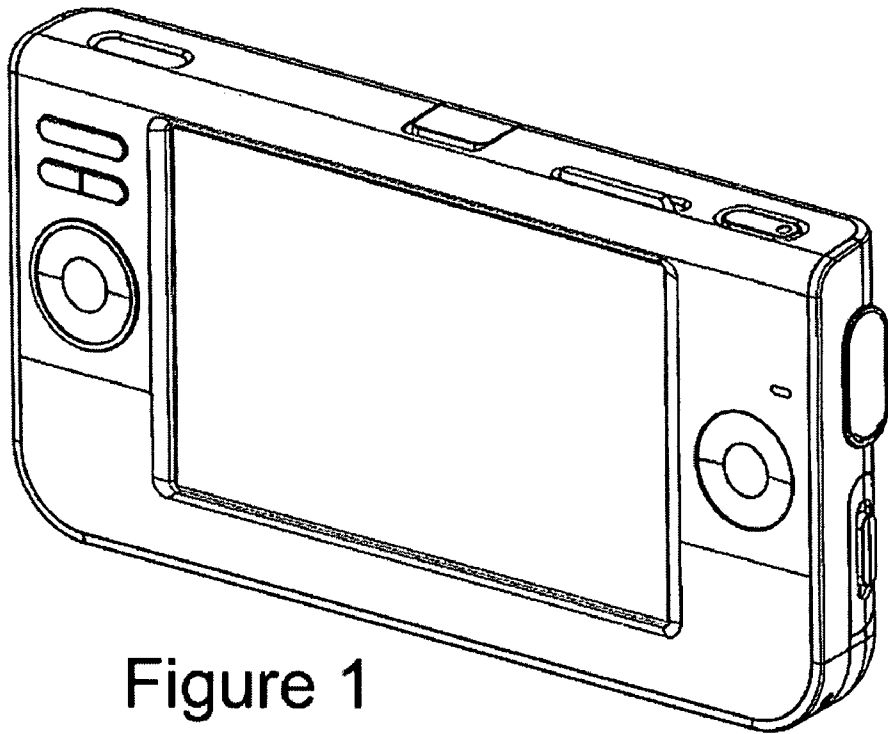

Figure 1

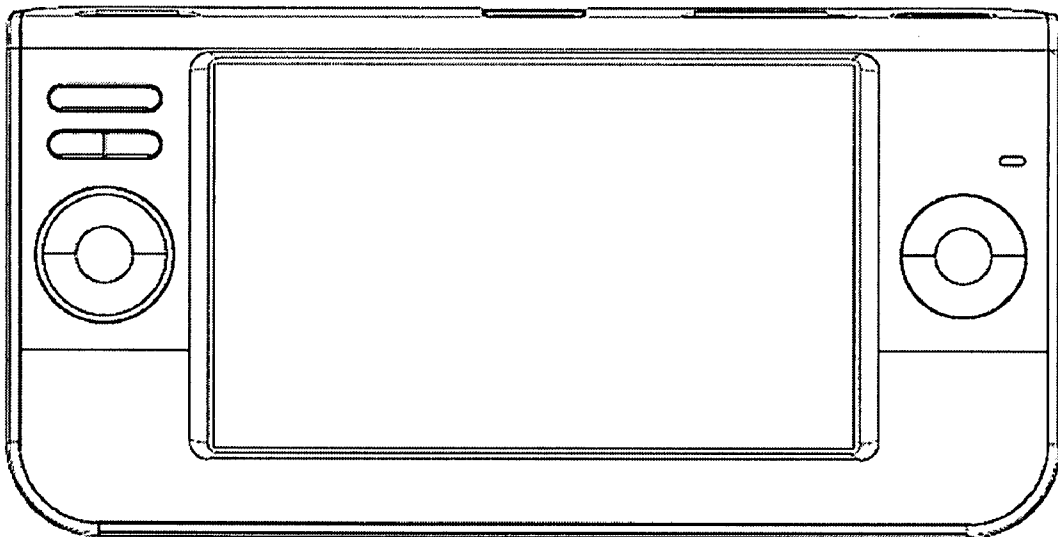

Figure 2

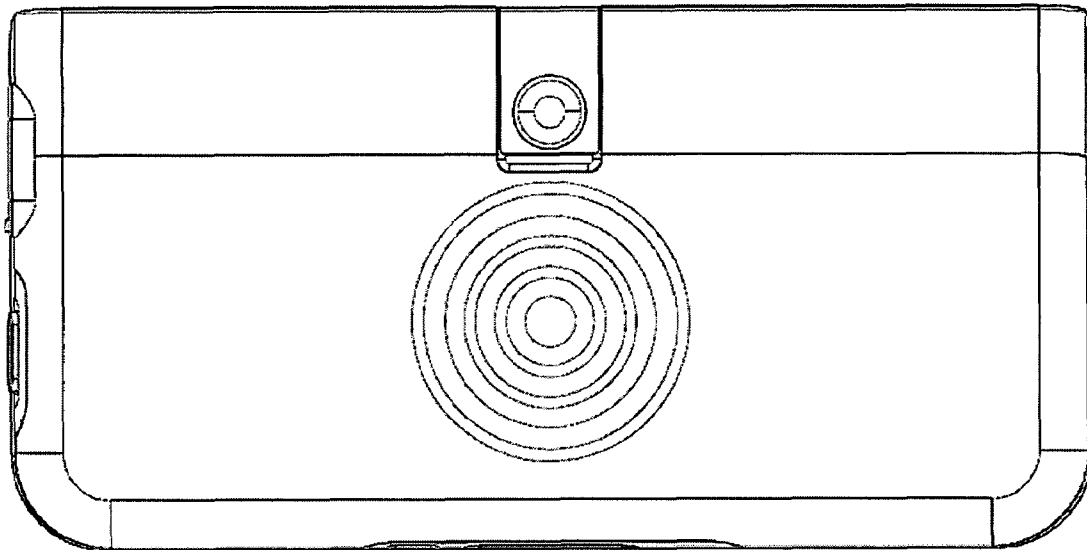

Figure 3

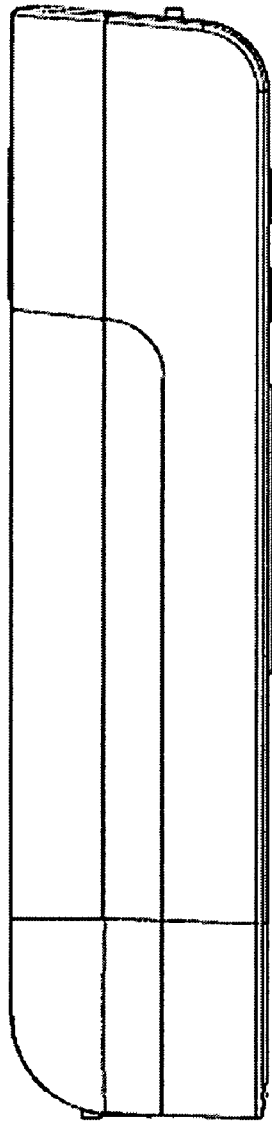

Figure 4

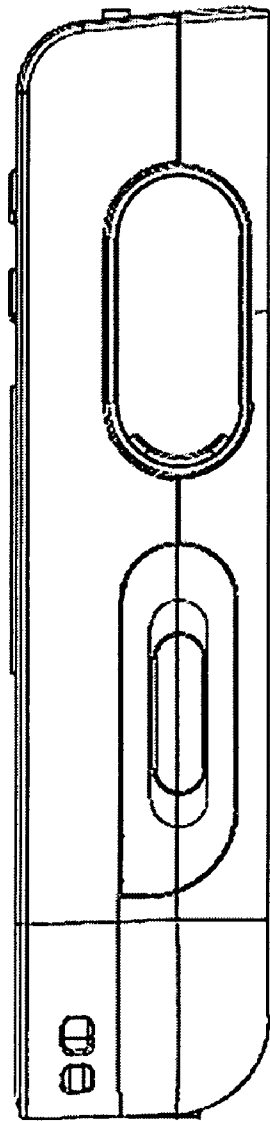

Figure 5

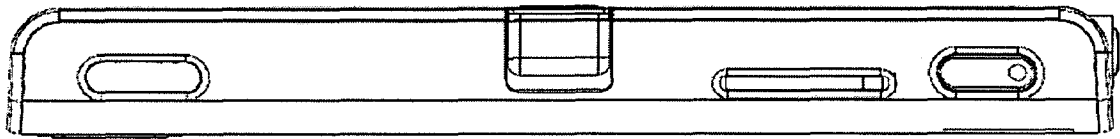

Figure 6

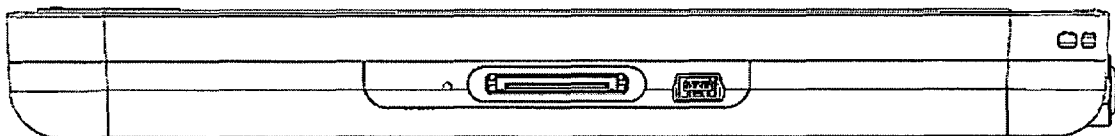

Figure 7

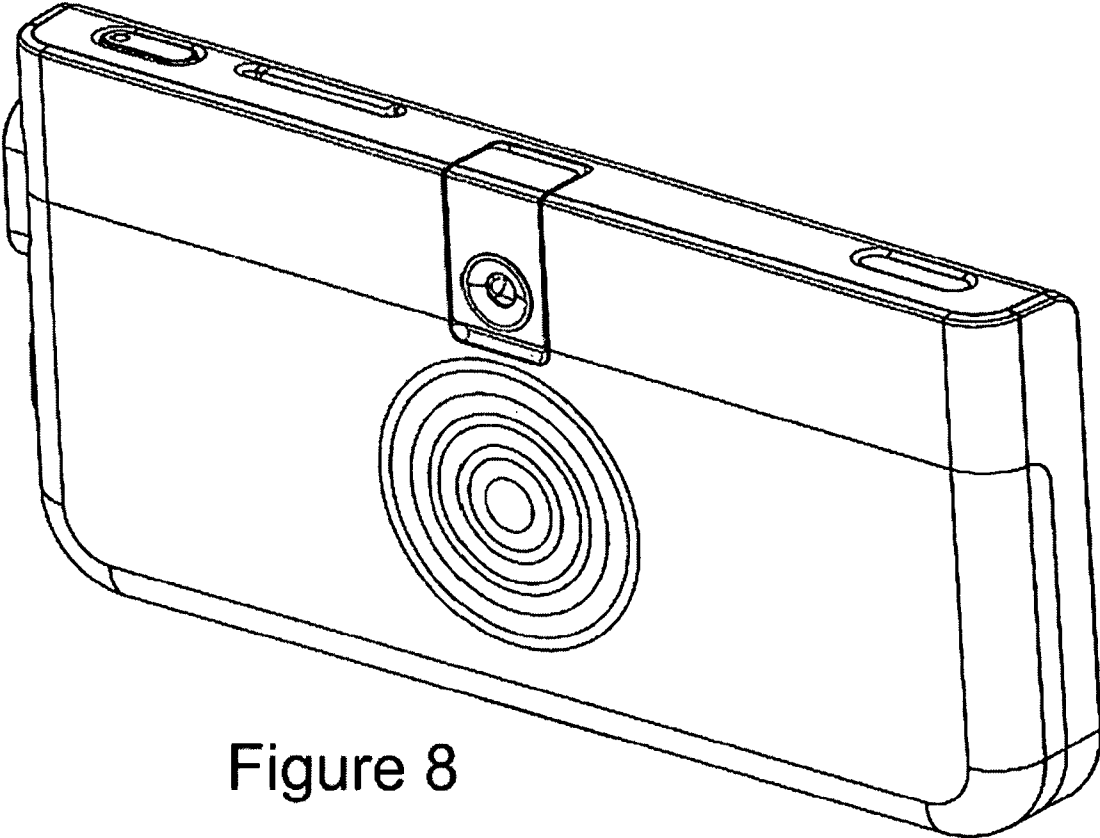

Figure 8