



(86) **Date de dépôt PCT/PCT Filing Date:** 2014/02/20
 (87) **Date publication PCT/PCT Publication Date:** 2014/08/28
 (85) **Entrée phase nationale/National Entry:** 2015/08/17
 (86) **N° demande PCT/PCT Application No.:** CA 2014/050118
 (87) **N° publication PCT/PCT Publication No.:** 2014/127478
 (30) **Priorité/Priority:** 2013/02/21 (US61/767,776)

(51) **Cl.Int./Int.Cl. C12N 7/01** (2006.01),
A61K 35/76 (2015.01), **A61K 39/00** (2006.01),
A61P 35/00 (2006.01), **A61P 37/04** (2006.01),
C07K 14/145 (2006.01), **C07K 14/47** (2006.01),
C07K 19/00 (2006.01), **C12N 15/113** (2010.01),
C12N 15/12 (2006.01), **C12N 15/47** (2006.01),
C12N 15/62 (2006.01), **C12N 15/86** (2006.01)

(71) **Demandeurs/Applicants:**
 CHILDREN'S HOSPITAL OF EASTERN ONTARIO
 RESEARCH INSTITUTE INC., CA;
 OTTAWA HOSPITAL RESEARCH INSTITUTE, CA;
 MCMASTER UNIVERSITY, CA

(72) **Inventeurs/Inventors:**

(54) **Titre : COMPOSITION DE VACCIN**
 (54) **Title: VACCINE COMPOSITION**

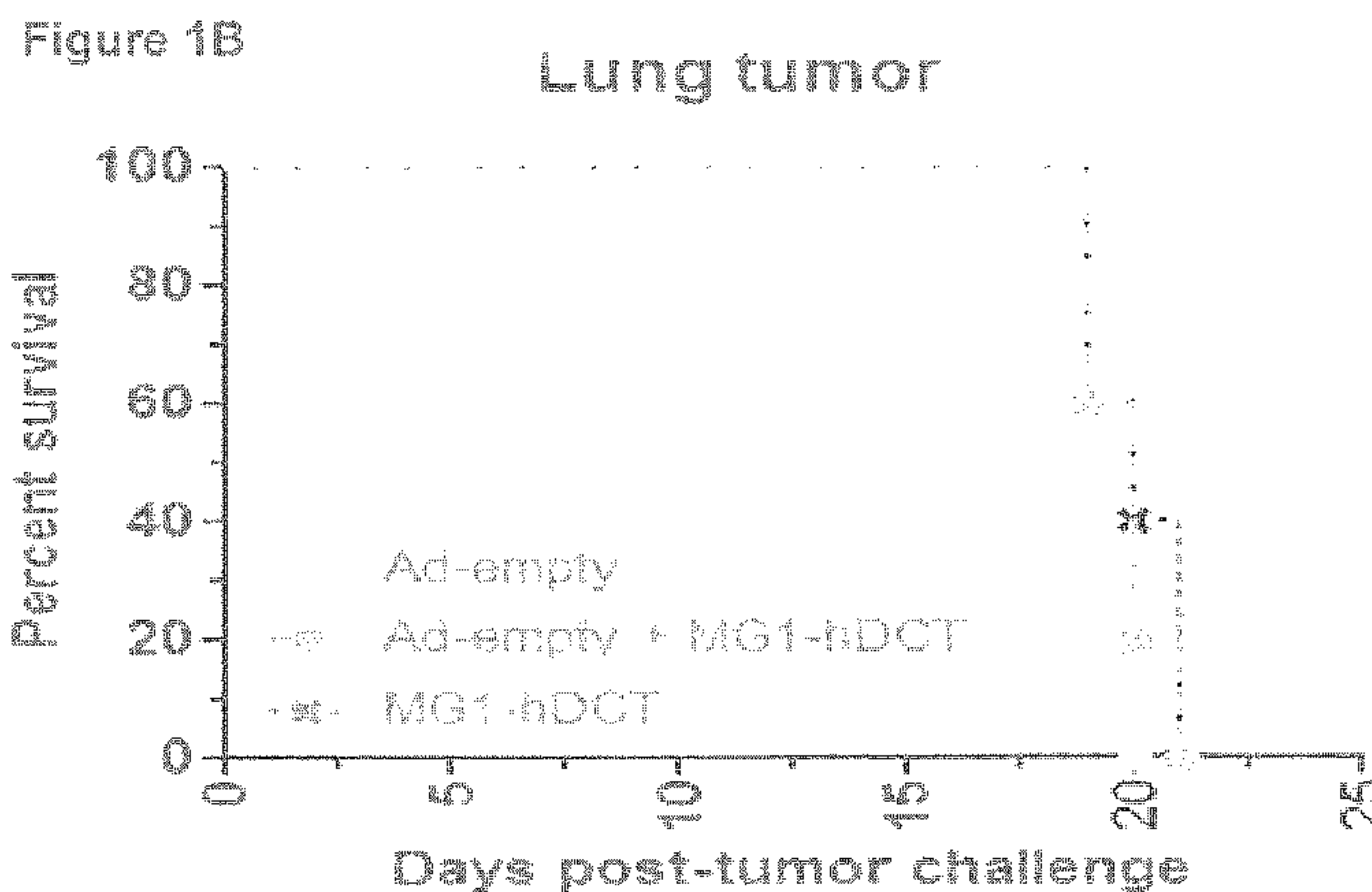
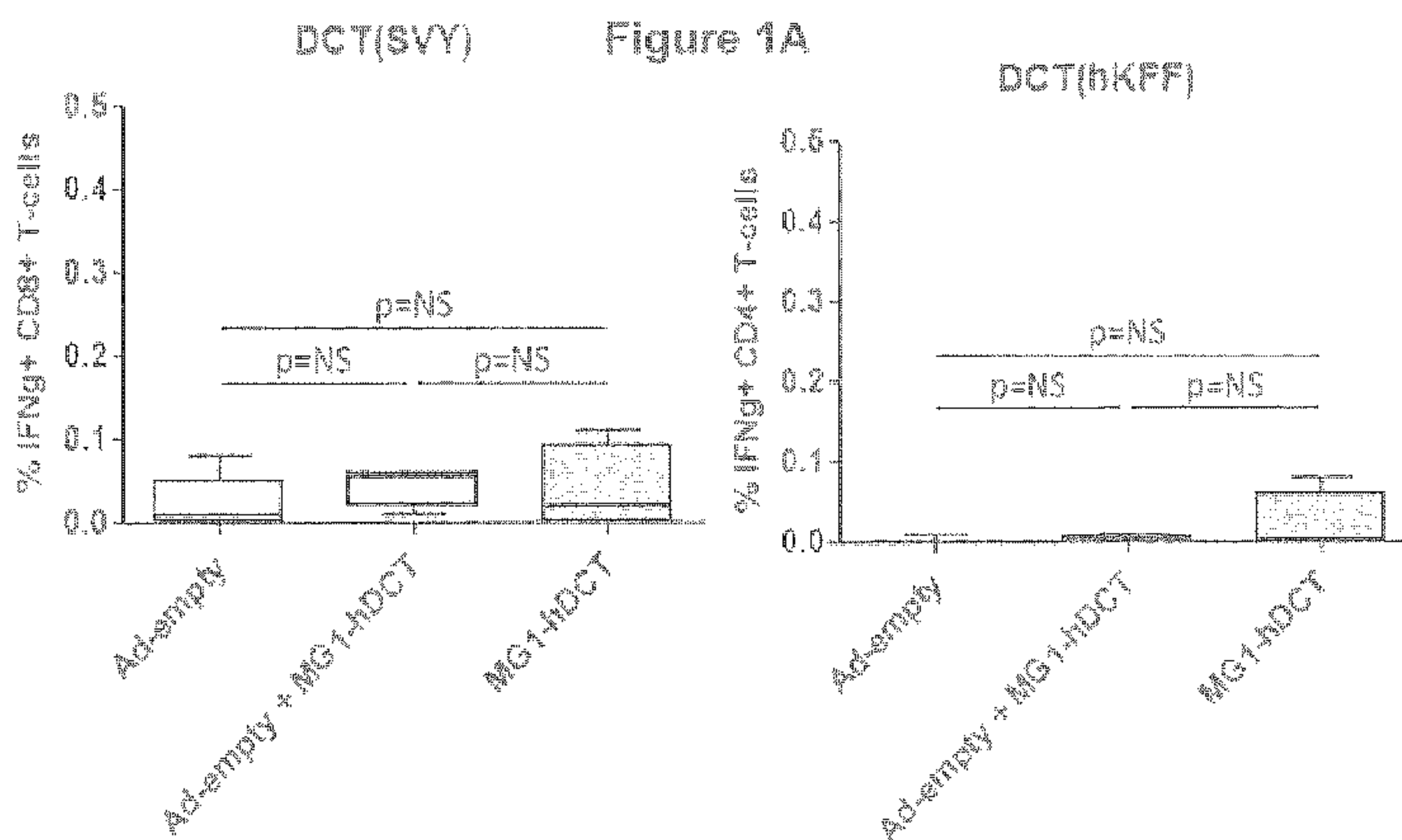

(57) **Abrégé/Abstract:**

There is described a kit for use in inducing an immune response in a mammal, the kit includes: a first virus that expresses MAGEA3, Human Papilloma Virus E6/E7 fusion protein, human Six-Transmembrane Epithelial Antigen of the Prostate protein, or

(72) **Inventeurs(suite)/Inventors(continued):** STOJDL, DAVID F., CA; BELL, JOHN C., CA; LICHTY, BRIAN, CA; POL, JONATHAN, FR

(74) **Agent:** BORDEN LADNER GERVAIS LLP

(57) **Abrégé(suite)/Abstract(continued):**

Cancer Testis Antigen 1, or a variant thereof as an antigenic protein and that is formulated to generate an immunity to the protein or variant thereof in the mammal. The kit also includes a Maraba MG1 virus encoding the same antigen, or a variant of the same antigen. The Maraba MG1 virus is formulated to induce the immune response in the mammal. The first virus is immunologically distinct from the Maraba MG1 virus.

(12) INTERNATIONAL APPLICATION PUBLISHED UNDER THE PATENT COOPERATION TREATY (PCT)

(19) World Intellectual Property
Organization
International Bureau(10) International Publication Number
WO 2014/127478 A1(43) International Publication Date
28 August 2014 (28.08.2014)

(51) International Patent Classification:

C12N 7/01 (2006.01) C07K 19/00 (2006.01)
A61K 35/76 (2006.01) C12N 15/113 (2010.01)
A61K 39/00 (2006.01) C12N 15/12 (2006.01)
A61P 35/00 (2006.01) C12N 15/47 (2006.01)
A61P 37/04 (2006.01) C12N 15/62 (2006.01)
C07K 14/145 (2006.01) C12N 15/86 (2006.01)
C07K 14/47 (2006.01)

501 Smyth Road, Ottawa, Ontario K1H 8L6 (CA). MC-
MASTER UNIVERSITY [CA/CA]; 1280 Main Street
West, Hamilton, Ontario L8S 4L8 (CA).(72) Inventors: STOJDL, David, F.; 17 Great Oak Private, Ot-
tawa, Ontario K1G 6P7 (CA). BELL, John, Cameron;
248 Knox Crescent, Ottawa, Ontario K1G 0K8 (CA).
LICHTY, Brian; 254 Highway 54, Brantford, Ontario
N3T 5L9 (CA).

(21) International Application Number:

PCT/CA2014/050118

(74) Agents: NAUMAN, David A. et al.; BORDEN LADNER
GERVAIS LLP, 1200 Waterfront Centre, 200 Burrard
Street, P.O. Box 48600, Vancouver, British Columbia V7X
1T2 (CA).

(22) International Filing Date:

20 February 2014 (20.02.2014)

(25) Filing Language:

English

(26) Publication Language:

English

(30) Priority Data:

61/767,776 21 February 2013 (21.02.2013) US

(71) Applicants: CHILDREN'S HOSPITAL OF EASTERN
ONTARIO RESEARCH INSTITUTE INC. [CA/CA];
401 Smyth Road, Ottawa, Ontario K1H 8L1 (CA). OTT-
AWA HOSPITAL RESEARCH INSTITUTE [CA/CA];(81) Designated States (unless otherwise indicated, for every
kind of national protection available): AE, AG, AL, AM,
AO, AT, AU, AZ, BA, BB, BG, BH, BN, BR, BW, BY,
BZ, CA, CH, CL, CN, CO, CR, CU, CZ, DE, DK, DM,
DO, DZ, EC, EE, EG, ES, FI, GB, GD, GE, GH, GM, GT,
HN, HR, HU, ID, IL, IN, IR, IS, JP, KE, KG, KN, KP, KR,
KZ, LA, LC, LK, LR, LS, LT, LU, LY, MA, MD, ME,
MG, MK, MN, MW, MX, MY, MZ, NA, NG, NI, NO, NZ,
OM, PA, PE, PG, PH, PL, PT, QA, RO, RS, RU, RW, SA,
SC, SD, SE, SG, SK, SL, SM, ST, SV, SY, TH, TJ, TM,

[Continued on next page]

(54) Title: VACCINE COMPOSITION

(57) Abstract: There is described a kit for use in inducing an
immune response in a mammal, the kit includes: a first virus
that expresses MAGEA3, Human Papilloma Virus E6/E7 fu-
sion protein, human Six-Transmembrane Epithelial Antigen
of the Prostate protein, or Cancer Testis Antigen 1, or a vari-
ant thereof as an antigenic protein and that is formulated to
generate an immunity to the protein or variant thereof in the
mammal. The kit also includes a Maraba MG1 virus encoding
the same antigen, or a variant of the same antigen. The Mara-
ba MG1 virus is formulated to induce the immune response in
the mammal. The first virus is immunologically distinct from
the Maraba MG1 virus.

Figure 1B



WO 2014/127478 A1

TN, TR, TT, TZ, UA, UG, US, UZ, VC, VN, ZA, ZM, ZW.

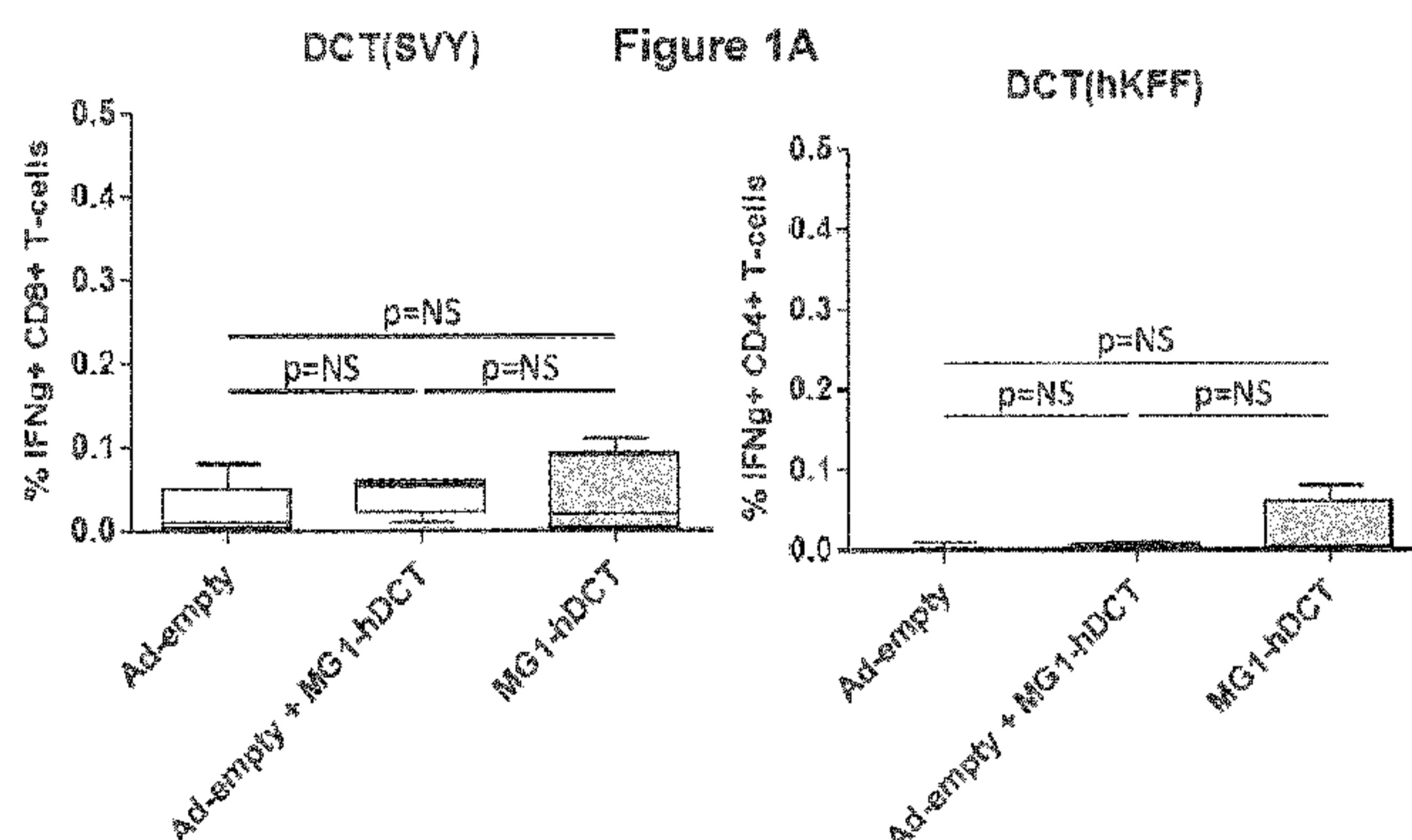
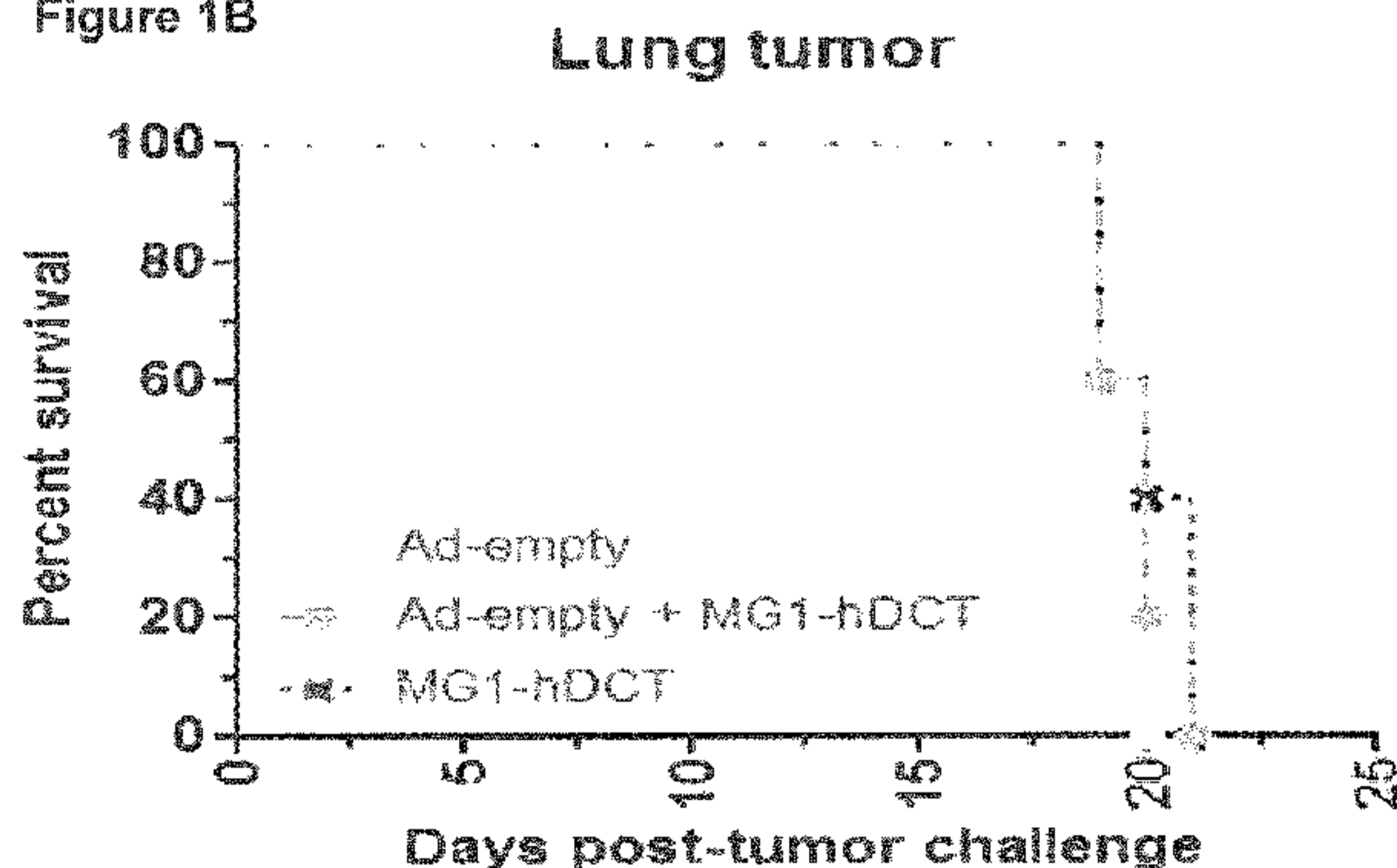
SM, TR), OAPI (BF, BJ, CF, CG, CI, CM, GA, GN, GQ, GW, KM, ML, MR, NE, SN, TD, TG).

(84) Designated States (*unless otherwise indicated, for every kind of regional protection available*): ARIPO (BW, GH, GM, KE, LR, LS, MW, MZ, NA, RW, SD, SL, SZ, TZ, UG, ZM, ZW), Eurasian (AM, AZ, BY, KG, KZ, RU, TJ, TM), European (AL, AT, BE, BG, CH, CY, CZ, DE, DK, EE, ES, FI, FR, GB, GR, HR, HU, IE, IS, IT, LT, LU, LV, MC, MK, MT, NL, NO, PL, PT, RO, RS, SE, SI, SK,

Declarations under Rule 4.17:

— *of inventorship (Rule 4.17(iv))*

Published:

— *with international search report (Art. 21(3))*

— *with sequence listing part of description (Rule 5.2(a))*

VACCINE COMPOSITION

CROSS REFERENCE TO RELATED APPLICATIONS

5 [0001] This application claims the benefit of priority of U.S. Provisional Patent Application No. 61/767,776 filed February 21, 2013, which is hereby incorporated by reference.

FIELD

10 [0002] The present disclosure relates to oncolytic viruses for inducing an immune response.

BACKGROUND

15 [0003] Oncolytic viruses (OVs) specifically infect, replicate in and kill malignant cells, leaving normal tissues unaffected. Several OVs have reached advanced stages of clinical evaluation for the treatment of various neoplasms (Russell SJ. et al., (2012) Nat Biotechnol 30:658-670). Once approved, such viral agents could substitute or combine with standard cancer therapies and allow for reduced toxicity and improved therapeutic efficacy.

20 [0004] In addition to the vesicular stomatitis virus (VSV) (Stojdl DF. et al., (2000) Nat Med 6:821-825; Stojdl DF. et al., (2003) Cancer Cell 4:263-275), other rhabdoviruses displaying oncolytic activity have been described recently (Brun J. et al., (2010) Mol Ther 18:1440-1449; Mahoney DJ. et al., (2011) Cancer Cell 20:443-456). Among them, the non-VSV Maraba virus showed the broadest oncotropism *in vitro* (WO 2009/016433). A mutant Maraba virus with improved tumor selectivity and reduced virulence in normal cells was engineered. The attenuated strain is a double mutant strain containing both G protein
25 (Q242R) and M protein (L123W) mutations. *In vivo*, this attenuated strain, called MG1 or Maraba MG1, demonstrated potent anti-tumor activity in xenograft and syngeneic tumor models in mice, with superior therapeutic efficacy than the attenuated VSV, VSVΔM51 (WO 2011/070440).

30 [0005] Data accumulated over the past several years has revealed that anti-tumor efficacy of oncolytic viruses not only depends on their direct oncolysis but may also depend on their ability to stimulate anti-tumor immunity (Bridle BW. et al., (2010) Mol Ther 18:4269-4275). This immune-mediated tumor control seems to play a critical role in the overall efficacy of OV therapy. Indeed, tumor-specific adaptive immune cells can patrol the tissues

and destroy tumor cells that have been missed by the OV. Moreover, their memory compartment can prevent tumor recurrence.

[0006] Various strategies have been developed to improve OV-induced anti-tumor immunity (Pol J. et al., (2012) Virus Adaptation and Treatment 4:1-21). Some groups have
5 genetically engineered OV expressing immunostimulatory cytokines. A herpes simplex and a vaccinia virus expressing Granulocyte-Macrophage Colony-Stimulating Factor (GM-CSF) have respectively reached phase III and IIB of the clinical evaluation for cancer therapy while a VSV expressing IFN- β has just entered phase I.

[0007] Another strategy, defined as an oncolytic vaccine, consists of expressing a
10 tumor antigen from the OV (Russell SJ. et al., (2012) Nat Biotechnol 30:658-670). Previously, it has been demonstrated that VSV could also be used as a cancer vaccine vector (Bridle BW. et al., (2010) Mol Ther 184:4269-4275). When applied in a heterologous prime-boost setting to treat a murine melanoma model, a VSV-human dopachrome tautomerase (hDCT) oncolytic vaccine not only induced an increased tumor-specific immunity to DCT but also a
15 concomitant reduction in antiviral adaptive immunity. As a result, the therapeutic efficacy was dramatically improved with an increase of both median and long term survivals (WO 2010/105347). Although VSV was shown to be effective using hDCT as a tumor associated antigen, there is no way to predict what tumor associated antigens will be effective in a heterologous prime-boost setting.

[0008] It is desirable to provide a vaccine vector that can be used to activate the
20 patient's immune system to kill tumour cells with reduced toxicity to normal tissues, for example by activating antibodies and/or lymphocytes against a tumor associated antigen on the tumour. It is desirable if such a vaccine vector displays both oncolytic activity and an ability to boost adaptive cell immunity.

SUMMARY

[0009] The following summary is intended to introduce the reader to one or more
inventions described herein but not to define any one of them.

[0010] It is an object of the present disclosure to obviate or mitigate at least one
30 disadvantage of previous anti-cancer vaccines.

[0011] The authors of the present disclosure have surprisingly determined that MAGEA3, Human Papilloma Virus E6/E7 fusion protein, human Six-Transmembrane Epithelial Antigen of the Prostate protein, and Cancer Testis Antigen 1, are all able to be

used in a heterologous prime-boost setting to induce an immune response in a mammal. These results are unexpected and not predictable since not all tumor associated antigens are able to induce an immune response via a heterologous prime-boost. For example, the authors of the present disclosure also determined that Placenta-specific protein 1 (PLAC-1) and Epstein-Barr Nuclear Antigen 1 were unable to stimulate an immune response via a heterologous prime-boost.

5 **[0012]** In a first aspect, there is provided a kit for use in inducing an immune response in a mammal. The kit includes: a first virus that expresses a protein comprising an amino acid sequence of SEQ ID NO: 1, or a variant thereof, as an antigenic protein and that is formulated to generate an immunity to the protein or variant thereof in the mammal. The kit also includes a Maraba MG1 virus encoding a protein comprising an amino acid sequence SEQ ID NO: 1, or a variant thereof, as an antigenic protein, the Maraba MG1 virus formulated to induce the immune response in the mammal; the first virus being immunologically distinct from the Maraba MG1 virus. The antigenic protein expressed by the first virus and the antigenic protein expressed by the Maraba MG1 virus may be identical.

15 **[0013]** The first virus, the Maraba MG1 virus, or both, may be formulated for administration as isolated viruses.

[0014] The Maraba MG1 virus may include a reverse complement and RNA version of a transgene comprising a nucleotide sequence of SEQ ID NO: 2. The Maraba MG1 virus may include a reverse complement and RNA version of a codon optimized transgene comprising a nucleotide sequence of SEQ ID NO: 3.

20 **[0015]** The first virus may include a transgene comprising a nucleotide sequence of SEQ ID NO: 2 or 3, or may include a reverse complement and RNA version of a transgene comprising a nucleotide sequence of SEQ ID NO: 2 or 3, depending on whether the first virus is a positive sense RNA virus, a DNA virus, or a negative sense RNA virus.

25 **[0016]** The two viruses may be capable of expressing different variants of the protein that comprises the sequence of SEQ ID NO: 1. The variant of the protein comprising an amino acid sequence of SEQ ID NO: 1 that is expressed by the first virus, the Maraba MG1 virus, or both, may include at least one tumor associated epitope selected from the group consisting of: FLWGPRALV, KVAELVHFL, EGDCAPEEK, KKLLTQHFVQENYLEY, RKVAELVHFLLLKYR, and KKLLTQHFVQENYLEY, and be at least 70% identical to SEQ ID NO: 1. Preferably, the variant will be at least 80% identical to SEQ ID NO: 1. More

preferably, the variant will be at least 90% identical to SEQ ID NO: 1. Even more preferably, the variant will be at least 95% identical to SEQ ID NO: 1.

[0017] The variant of the protein comprising an amino acid sequence of SEQ ID NO: 1 that is expressed by the first virus, the Maraba MG1 virus, or both, may have an amino acid
5 sequence of SEQ ID NO: 4. The nucleotide sequence that encodes the variant may include a nucleotide sequence of SEQ ID NO: 5.

[0018] The Maraba MG1 virus may include a reverse complement and RNA version of a nucleotide sequence of SEQ ID NO: 5. The first virus may include a transgene comprising a nucleotide sequence of SEQ ID NO: 5, or may include a reverse complement
10 and RNA version of a transgene comprising a nucleotide sequence of SEQ ID NO: 5, depending on whether the first virus is a positive sense RNA virus, a DNA virus, or a negative sense RNA virus.

[0019] If the first virus is a negative sense RNA virus, one of either the Maraba MG1 virus or the first virus may include a reverse complement and RNA version of a nucleotide
15 sequence of SEQ ID NO: 2 or 3, and the other of the Maraba MG1 virus and the first virus may include a reverse complement and RNA version of SEQ ID NO: 5.

[0020] If the first virus is a positive sense RNA virus or a DNA virus, the Maraba MG1 virus may include a reverse complement and RNA version of a nucleotide sequence of SEQ
ID NO: 2 or 3, and the first virus may include a nucleotide sequence of SEQ ID NO: 5.

20 Alternatively, the Maraba MG1 virus may include a reverse complement and RNA version of a nucleotide sequence of SEQ ID NO: 5, and the first virus may include a nucleotide sequence of SEQ ID NO: 2 or 3.

[0021] One of either the Maraba MG1 virus or the first virus may be capable of expressing a protein that comprises the sequence of SEQ ID NO: 1 or 4, and the other of the
25 Maraba MG1 virus and the first virus may be capable of expressing a protein that comprises the other sequence.

[0022] The first virus may be an adenovirus.

[0023] According to another aspect, there is provided an isolated Maraba MG1 viral particle having a genome that encodes a protein comprising an amino acid sequence of SEQ
30 ID NO: 1, or a variant thereof.

[0024] The variant of the protein comprising an amino acid sequence of SEQ ID NO: 1 may have an amino acid sequence of SEQ ID NO: 4.

[0025] The genome may include a reverse complement and RNA version of a nucleotide sequence of SEQ ID NO: 2 or 3.

[0026] The genome may include a reverse complement and RNA version of a nucleotide sequence of SEQ ID NO: 5.

5 **[0027]** The genome may include a reverse complement and RNA version of a nucleotide sequence of SEQ ID NO: 6.

[0028] In another aspect, there is provided a kit for use in inducing an immune response in a mammal. The kit includes: a first virus that expresses a protein comprising an amino acid sequence of SEQ ID NO: 7, or a variant thereof, as an antigenic protein and that
10 is formulated to generate an immunity to the protein or variant thereof in the mammal. The kit also includes a Maraba MG1 virus encoding a protein comprising an amino acid sequence of SEQ ID NO: 7, or a variant thereof, as an antigenic protein, the Maraba MG1 virus formulated to induce the immune response in the mammal; the first virus being immunologically distinct from the Maraba MG1 virus. The antigenic protein expressed by the
15 first virus and the antigenic protein expressed by the Maraba MG1 virus may be identical.

[0029] The first virus, the Maraba MG1 virus, or both, may be formulated for administration as isolated viruses.

[0030] If the first virus is a negative sense RNA virus, the Maraba MG1 virus, the first virus, or both may include a reverse complement and RNA version of a codon optimized
20 transgene comprising a nucleotide sequence of SEQ ID NO: 8. If the first virus is a DNA virus or a positive sense RNA virus, the first virus may include a codon optimized transgene comprising a nucleotide sequence of SEQ ID NO: 8.

[0031] The variant of the protein comprising an amino acid sequence of SEQ ID NO: 7 that is expressed by the first virus, the Maraba MG1 virus, or both, may include at least one
25 tumor associated epitope and be at least 70% identical to SEQ ID NO: 7. Preferably, the variant will be at least 80% identical to SEQ ID NO: 7. More preferably, the variant will be at least 90% identical to SEQ ID NO: 7. Even more preferably, the variant will be at least 95% identical to SEQ ID NO: 7.

[0032] One of either the Maraba MG1 virus or the first virus may be capable of
30 expressing a protein that comprises the sequence of SEQ ID NO: 7, and the other of the Maraba MG1 virus and the first virus may be capable of expressing a variant of a protein that comprises the sequence of SEQ ID NO: 7. The two viruses may be capable of expressing different variants of the protein that comprises the sequence of SEQ ID NO: 7.

[0033] The first virus may be a lentivirus.

[0034] According to another aspect, there is provided an isolated Maraba MG1 viral particle having a genome that encodes encodes a protein comprising an amino acid sequence of SEQ ID NO: 7, or a variant thereof.

5 **[0035]** The genome may include a reverse complement and RNA version of a nucleotide sequence of SEQ ID NO: 8.

[0036] The genome may include a nucleotide sequence that is the reverse complement and RNA version of SEQ ID NO: 9.

[0037] In another aspect, there is provided a kit for use in inducing an immune
10 response in a mammal. The kit includes: a first virus that expresses a protein comprising an amino acid sequence of SEQ ID NO: 10, or a variant thereof, as an antigenic protein and that is formulated to generate an immunity to the protein or variant thereof in the mammal. The kit also includes a Maraba MG1 virus encoding a protein comprising an amino acid sequence of SEQ ID NO: 10, or a variant thereof, as an antigenic protein, the Maraba MG1 virus
15 formulated to induce the immune response in the mammal; the first virus being immunologically distinct from the Maraba MG1 virus. The antigenic protein expressed by the first virus and the antigenic protein expressed by the Maraba MG1 virus may be identical.

[0038] The first virus, the Maraba MG1 virus, or both, may be formulated for administration as isolated viruses.

20 **[0039]** If the first virus is a negative sense RNA virus, the Maraba MG1 virus, the first virus, or both may include a reverse complement and RNA version of a codon optimized transgene comprising a nucleotide sequence of SEQ ID NO: 11. If the first virus is a DNA virus or a positive sense RNA virus, the first virus may include a codon optimized transgene comprising a nucleotide sequence of SEQ ID NO: 11.

25 **[0040]** The variant of the protein comprising an amino acid sequence of SEQ ID NO: 10 that is expressed by the first virus, the Maraba MG1 virus, or both, may include at least one tumor associated epitope and be at least 70% identical to SEQ ID NO: 10. Preferably, the variant will be at least 80% identical to SEQ ID NO: 10. More preferably, the variant will be at least 90% identical to SEQ ID NO: 10. Even more preferably, the variant will be at least
30 95% identical to SEQ ID NO: 10.

[0041] One of either the Maraba MG1 virus or the first virus may be capable of expressing a protein that comprises the sequence of SEQ ID NO: 10, and the other of the Maraba MG1 virus and the first virus may be capable of expressing a variant of a protein that

comprises the sequence of SEQ ID NO: 10. The two viruses may be capable of expressing different variants of the protein that comprises the sequence of SEQ ID NO: 10.

[0042] The first virus may be a lentivirus.

[0043] According to another aspect, there is provided an isolated Maraba MG1 viral particle having a genome that encodes encodes a protein comprising an amino acid sequence of SEQ ID NO: 10, or a variant thereof.

[0044] The genome may include a reverse complement and RNA version of a nucleotide sequence of SEQ ID NO: 11.

[0045] The genome may include a nucleotide sequence that is the reverse complement and RNA version of SEQ ID NO: 12.

[0046] In another aspect, there is provided a kit for use in inducing an immune response in a mammal. The kit includes: a first virus that expresses a protein comprising an amino acid sequence of SEQ ID NO: 13, or a variant thereof, as an antigenic protein and that is formulated to generate an immunity to the protein or variant thereof in the mammal. The kit also includes a Maraba MG1 virus encoding a protein comprising an amino acid sequence of SEQ ID NO: 13, or a variant thereof, as an antigenic protein, the Maraba MG1 virus formulated to induce the immune response in the mammal; the first virus being immunologically distinct from the Maraba MG1 virus. The antigenic protein expressed by the first virus and the antigenic protein expressed by the Maraba MG1 virus may be identical.

[0047] The first virus, the Maraba MG1 virus, or both, may be formulated for administration as isolated viruses.

[0048] If the first virus is a negative sense RNA virus, the Maraba MG1 virus, the first virus, or both may include a reverse complement and RNA version of a codon optimized transgene comprising a nucleotide sequence of SEQ ID NO: 14. If the first virus is a DNA virus or a positive sense RNA virus, the first virus may include a codon optimized transgene comprising a nucleotide sequence of SEQ ID NO: 14.

[0049] The variant of the protein comprising an amino acid sequence of SEQ ID NO: 13 that is expressed by the first virus, the Maraba MG1 virus, or both, may include at least one tumor associated epitope and be at least 70% identical to SEQ ID NO: 13. Preferably, the variant will be at least 80% identical to SEQ ID NO: 13. More preferably, the variant will be at least 90% identical to SEQ ID NO: 13. Even more preferably, the variant will be at least 95% identical to SEQ ID NO: 13.

[0050] One of either the Maraba MG1 virus or the first virus may be capable of expressing a protein that comprises the sequence of SEQ ID NO: 13, and the other of the Maraba MG1 virus and the first virus may be capable of expressing a variant of a protein that comprises the sequence of SEQ ID NO: 13. The two viruses may be capable of expressing
5 different variants of the protein that comprises the sequence of SEQ ID NO: 13.

[0051] The first virus may be a lentivirus.

[0052] According to another aspect, there is provided an isolated Maraba MG1 viral particle having a genome that encodes encodes a protein comprising an amino acid sequence of SEQ ID NO: 13, or a variant thereof.

10 **[0053]** The genome may include a reverse complement and RNA version of a nucleotide sequence of SEQ ID NO: 14.

[0054] The genome may include a nucleotide sequence that is the reverse complement and RNA version of SEQ ID NO: 15.

15 **[0055]** Other aspects and features of the present disclosure will become apparent to those ordinarily skilled in the art upon review of the following description of specific embodiments in conjunction with the accompanying figures.

BRIEF DESCRIPTION OF THE DRAWINGS

20 **[0056]** Embodiments of the present disclosure will now be described, by way of example only, with reference to the attached Figures.

[0057] Fig. 1A shows the CD8⁺ or CD4⁺ T-cell responses in tumor-bearing mice administered with MG1-hDCT.

[0058] Fig. 1B shows the therapeutic efficacy of MG1-hDCT administered as a priming vector only in a metastatic lung cancer mouse model.

25 **[0059]** Fig. 2 shows the comparison of the immune response of a prime-boost vaccination in C57/Bl6 mice with Ad-hDCT as the priming vector and either Maraba MG1-hDCT or VSV-hDCT as the boosting vector.

30 **[0060]** Fig. 3 shows the T-cell response in a metastatic lung cancer mouse model following Ad-empty or Ad-hDCT, as the priming vector only or following prime-boost vaccination with Ad-hDCT, as the priming vector and either Maraba MG1 GFP or Maraba MG1-hDCT, as the boosting vector.

[0061] Fig. 4 shows the survival plot in a metastatic lung cancer mouse model following Ad-empty or Ad-hDCT, as the priming vector only or following prime-boost

vaccination with Ad-hDCT, as the priming vector and either Maraba MG1 GFP or Maraba MG1-hDCT, as the boosting vector.

[0062] Fig. 5 shows the survival plot in a metastatic brain cancer mouse model following Ad-empty or Ad-hDCT, as the priming vector only or following prime-boost vaccination with Ad-hDCT, as the priming vector and Maraba MG1-hDCT, as the boosting vectormm.

[0063] Fig. 6 is a diagram of the priming vector Ad-MAGEA3, the boosting vector Maraba MG1-MAGEA3 and the prime-boost strategy utilized in a primate toxicity/immunogenicity study.

[0064] Fig. 7 shows the average T-cell response in primates given Ad-MAGEA3 as the priming vector and a high or low dose of MG1-MAGEA3 as the boosting vector. The T-cell responses were determined after 5, 13 and 84 days following the boosting vector.

[0065] Fig. 8 shows the T-cell responses in individual primates given Ad-MAGEA3 as the priming vector and MG1-MAGEA3 as the boosting vector after 5 days following the boosting vector. The T-cell responses were stratified in relation to the MAGEA3 peptide pool used to stimulate the response.

[0066] Fig. 9 shows the survival plot in a metastatic lung cancer mouse model following Ad-hDCT versus Ad-hDCT plus Cyclophosphamide, as the priming vector only or following prime-boost vaccination with Ad-hDCT versus Ad-hDCT plus Cyclophosphamide, as the priming vector and VSV-hDCT, as the boosting vector.

DETAILED DESCRIPTION

[0067] The present disclosure provides a kit for use in inducing an immune response in a mammal. The kit includes a first virus that expresses MAGEA3, a Human Papilloma Virus E6/E7 fusion protein, human Six-Transmembrane Epithelial Antigen of the Prostate protein, or Cancer Testis Antigen 1, or a variant thereof, as an antigen and that is formulated to generate an immunity to the antigen in the mammal. The kit also includes a Maraba MG1 virus encoding the same antigen, or a variant of the same antigen, the Maraba MG1 virus formulated to induce the immune response in the mammal. The first virus is immunologically distinct from the Maraba MG1 virus so that it may act as the "prime" in a heterologous prime-boost vaccination.

[0068] Prime:boost immunizations can be given with unmatched vaccine delivery methods while using the same antigen, in a 'heterologous' prime-boost format; or with

matched vaccine delivery methods, in a 'homologous' prime-boost. Heterologous prime-boost methods are preferable when using vectored vaccine platforms as homologous vaccination would lead to boosting of responses to both the vector and the transgene in the secondary response. In contrast, a heterologous system focuses the secondary response (that is, the boosted response) on the antigen as responses against the first and the second vector are primary responses, and are therefore much less robust.

[0069] In the present disclosure, the first virus and the Maraba MG1 virus are used in a heterologous prime-boost format.

[0070] The antigenic proteins listed above are self-antigens already tolerized by the immune system through a tightly controlled process of negative selection in the thymus (Kruisbeek AM and Amsen D, (1996) *Curr Opin Immunol* 8:233-244; Stockinger B (1999) *Adv Immunol* 71:229-265) or peripheral tolerization. The major challenge with developing vaccines to these antigenic proteins, and any other self-antigens, is to induce a strong immune response directed selectively against cancer cells. Although a number of tumor associated antigenic peptides have been discovered, the authors of the present disclosure have determined that is impossible to predict which tumor associated antigenic peptides can be successfully used to develop vaccines.

[0071] Melanoma antigen, family A,3 (MAGEA3) is a "cancer testis antigen". The MAGE family of genes encoding tumor specific antigens is discussed in De Plaen et al., *Immunogenetics* 40:360-369 (1994), MAGEA3 is expressed in a wide variety of tumours including melanoma, colorectal and lung. This protein was used by the authors of the present disclosure as the antigenic protein in both the first virus and the Maraba MG1 virus. The authors also used a variant of the MAGEA3 protein as the antigenic protein in both the first virus and the Maraba MG1 virus.

[0072] Human Papilloma Virus (HPV) oncoproteins E6/E7 are constitutively expressed in cervical cancer (Zur Hausen, H (1996) *Biochem Biophys Acta* 1288:F55-F78). Furthermore, HPV types 16 and 18 are the cause of 75% of cervical cancer (Walboomers JM (1999) *J Pathol* 189:12-19). The authors of the present disclosure used a fusion protein of the E6/E7 oncoproteins of HPV types 16 and 18 as the antigenic protein. The fusion protein was expressed using a nucleotide sequence coexpressing HPV type 16/18 E6/E7 as a fusion protein, which was mutated to remove oncogenic potential. The fusion protein was used by the authors of the present disclosure as the antigenic protein in both the first virus and the Maraba MG1 virus.

[0073] Six-Transmembrane Epithelial Antigen of the Prostate (huSTEAP) is a recently identified protein shown to be overexpressed in prostate cancer and up-regulated in multiple cancer cell lines, including pancreas, colon, breast, testicular, cervical, bladder, ovarian, acute lymphocytic leukemia and Ewing sarcoma (Hubert RS et al., (1999) Proc Natl Acad Sci 96:14523-14528). The STEAP gene encodes a protein with six potential membrane-spanning regions flanked by hydrophilic amino- and carboxyl-terminal domains. This protein was used by the authors of the present disclosure as the antigenic protein in both the first virus and the Maraba MG1 virus.

[0074] Cancer Testis Antigen 1 (NYESO1) is a cancer/testis antigen expressed in normal adult tissues, such as testis and ovary, and in various cancers (Nicholaou T et al., (2006) Immunol Cell Biol 84:303-317). Cancer testis antigens are a unique family of antigens, which have restricted expression to testicular germ cells in a normal adult but are aberrantly expressed on a variety of solid tumours, including soft tissue sarcomas, melanoma and epithelial cancers. This protein was used by the authors of the present disclosure as the antigenic protein in both the first virus and the Maraba MG1 virus.

[0075] In contrast to the successful use of the MAGEA3, HPV E6/E7 fusion, the huSTEAP, and the NYESO1 proteins as antigenic proteins in a heterologous prime-boost vaccine, the authors of the present disclosure determined that Epstein-Barr Nuclear Antigen 1 (EBDNA1, SEQ ID NO: 16, encoded by SEQ ID NO: 17) was unable to generate a similar immune response. EBDNA1 is a multifunctional viral protein associated with Epstein-Barr virus (EBV) (Sibille H et al., (2003) Proc Natl Acad Sci 100:10989-10994) and consistently expressed in EBV-associated tumours (Young LS et al., (2004) Nature Reviews – Cancer 4:757-768). EBNA1 has a glycine–alanine repeat sequence that separates the protein into amino- and carboxy-terminal domains (Young LS (2004) Nature Reviews – Cancer 4:757-768). This sequence also seems to stabilize the protein, preventing proteasomal breakdown, as well as impairing antigen processing and MHC class I-restricted antigen presentation. This thereby inhibits the CD8-restricted cytotoxic T cell response against virus-infected cells (Levitskaya J et al., (1995) Nature 375:685-688).

[0076] Placenta-specific protein 1 (PLAC-1) is another example of a tumor associated antigenic protein that was unable to generate an immune response in a heterologous prime-boost vaccine.

[0077] In the context of the present disclosure, a “variant” of a tumor associated antigenic protein refers to a protein that (a) includes at least one tumor associated antigenic

epitope from the tumor associated antigenic protein and (b) is at least 70% identical to the tumor associated antigenic protein. Preferably, the variant will be at least 80% identical to the tumor associated antigenic protein. More preferably, the variant will be at least 90% identical to the tumor associated antigenic protein. Even more preferably, the variant will be at least 95% identical to the tumor associated antigenic protein. Variants with higher sequence identities have increased likelihood that the epitopes are presented in a similar 3-dimensional manner to the wild type antigenic proteins.

[0078] Generally, a tumor associated antigenic epitope may be identified by breaking up the whole antigenic protein into overlapping series of peptides, or by generating libraries of random peptides, and looking for T cell responses by stimulating PBMCs or splenocytes from animals vaccinated with the protein target using the peptide pools. Pools having a response identify that peptide as a potential antigenic epitope. This approach is discussed by Morris, GE in Encyclopedia of Life Sciences, 2007, page 1-3 (doi: 10.1002/9780470015902.a0002624.pub2).

[0079] A database summarizing well accepted antigenic epitopes is provided by Van der Bruggen P, Stroobant V, Vigneron N, Van den Eynde B in "Database of T cell-defined human tumor antigens: the 2013 update." *Cancer Immun* 2013 13:15 and at <<http://www.cancerimmunity.org/peptide/>>.

[0080] Tumor associated antigenic epitopes have been already identified for MAGEA3. Accordingly, a variant of the MAGEA3 protein may be, for example, an antigenic protein that includes at least one tumor associated antigenic epitope selected from the group consisting of: EVDPIGHLY, FLWGPRALV, KVAELVHFL, TFPDLESEF, VAELVHFL, MEVDPIGHLY, EVDPIGHLY, REPVTKAEM, AELVHFL, MEVDPIGHLY, WQYFFPVIF, EGDCAPEEK, KKLLTQHFVQENYLEY, RKVAELVHFL, KKLLTQHFVQENYLEY, ACYEFLWGPRALVETS, RKVAELVHFL, VIFSKASSSLQL, VIFSKASSSLQL, VFGIELMEVDPIGHL, GDNQIMPKAGLLIIV, TSYVKVLHHMVKISG, RKVAELVHFL, and FLLLKYRAREPVTKAE; and that is at least 70% identical to the MAGEA3 protein.

[0081] It may be desirable for variants of a tumor associated antigenic protein to include only antigenic epitopes that have high allelic frequencies, such as frequencies greater than 40% of the population. Accordingly, preferred examples of variants of MAGEA3 may include proteins that include at least one antigenic epitope selected from the group consisting of: FLWGPRALV, KVAELVHFL, EGDCAPEEK, KKLLTQHFVQENYLEY,

RKVAELVHFLLLKYR, and KKLLTQHFVQENYLEY; and that is at least 70% identical to the MAGEA3 protein.

[0082] The antigen expressed by the first virus does not need to have exactly the same sequence as the antigen expressed by the Maraba MG1 virus. The antigen expressed
5 by Maraba MG1 must only induce an overlapping immune response to the antigen expressed by the first virus. For example, the first virus may express the MAGEA3 and the Maraba MG virus may express a MAGEA3 variant, or vice versa. Since both MAGEA3 and the variant of MAGEA3 induce overlapping immune responses (as they both include at least one identical tumor associated antigenic sequence), the first virus acts as the prime and the
10 Maraba MG1 virus acts as the boost. It is sufficient that the immune response generated in the mammal to the first antigen results in an immune response primarily to the MAGEA3 or MAGEA3 variant when the Maraba MG1 virus is administered.

[0083] In the context of the present disclosure, it should be understood that all discussions of, and references to, a 'protein expressed by a virus' more exactly refer to a
15 protein expressed by a cell infected with the virus since viruses do not themselves have the capability to express proteins. Similarly, all discussions of, and references to, a 'virus that expresses a protein' or 'virus capable of expressing a protein' more exactly refer to a virus that includes the genetic information necessary for the protein to be expressed by a cell infected with the virus.

[0084] The kit may additionally include an immune-potentiating compound, such as cyclophosphamide (CPA), that increases the prime immune response to the tumor associated antigenic protein generated in the mammal by administering the first virus. Cyclophosphamide is a chemotherapeutic agent that may lead to enhanced immune
20 responses against the tumor associated antigenic protein. In a synergistic murine melanoma tumor model, CPA administered prior to the priming vector significantly increased survival, while CPA administered prior to the boosting vector did not.

[0085] The therapeutic approach disclosed herein combines: (1) a viral vaccine, and (2) Maraba MG1 virus as an oncolytic viral vaccine, both expressing MAGEA3, Human Papilloma Virus E6/E7 fusion protein, human Six-Transmembrane Epithelial Antigen of the
30 Prostate protein, or Cancer Testis Antigen 1, or a variant thereof. Boosting with the oncolytic vaccine may lead to both tumour debulking by the oncolytic virus and a large increase in the number of tumour-specific CTL (cytotoxic T-lymphocytes) in animals primed by the viral vaccine. Paradoxically, this methodology actually generates larger anti-tumour responses in

tumour-bearing, as compared to tumour-free, animals since the replication of oncolytic virus is amplified in the tumor-bearing animals, which leads to an increase in the number of antigen-specific Tumour Infiltrating Lymphocytes (TILs), when compared to the replication of oncolytic virus in the tumor-free animals and the associated number of antigen-specific
5 Tumour Infiltrating Lymphocytes (TILs).

[0086] The expression products of these genes are processed into peptides, which, in turn, are expressed on cell surfaces. This can lead to lysis of the tumour cells by specific CTLs. The T cell response to foreign antigens includes both cytolytic T lymphocytes and helper T lymphocytes. CD8⁺ cytotoxic or cytolytic T cells (CTLs) are T cells which, when
10 activated, lyse cells that present the appropriate antigen presented by HLA class I molecules. CD4⁺ T helper cells are T cells which secrete cytokines to stimulate macrophages and antigen-producing B cells which present the appropriate antigen by HLA class II molecules on their surface.

[0087] The protein "MAGEA3" may be also referred to as "MAGE-A3" and stands for
15 melanoma-associated antigen 3. The antigenic MAGEA3 protein according to the present disclosure is a protein that includes the amino acid sequence of SEQ ID NO: 1. This amino acid sequence may be encoded by the nucleotide sequence of SEQ ID NO: 2. Alternatively, the amino acid sequence may be encoded by a codon optimized transgene that includes the nucleotide sequence of SEQ ID NO: 3. A negative sense RNA virus that expresses the
20 protein of SEQ ID NO: 1 may include a reverse complement and RNA version of a polynucleotide of SEQ ID NO: 2 or 3. A positive sense RNA virus or a DNA virus that expresses the protein of SEQ ID NO: 1 may include a sequence that is SEQ ID NO: 2 or 3.

[0088] An example of an antigenic MAGEA3 variant protein according to the present disclosure is a protein that includes the amino acid sequence of SEQ ID NO: 4. This amino
25 acid sequence may be encoded by the nucleotide sequence of SEQ ID NO: 5. A negative sense RNA virus that expresses the protein of SEQ ID NO: 4 may include an RNA polynucleotide which includes a sequence that is a reverse complement and RNA version of SEQ ID NO: 5. A DNA virus or RNA virus that expresses the protein of SEQ ID NO: 4 may include a sequence that is SEQ ID NO: 5.

[0089] One example of such a negative sense RNA virus is a Maraba virus that
30 includes the reverse complement and RNA version of SEQ ID NO: 6.

[0090] The antigenic protein "E6/E7 fusion protein" or "Human Papilloma Virus E6/E7 fusion protein" according to the present disclosure is a protein that includes the amino acid

sequence of SEQ ID NO: 7. This amino acid sequence may be encoded by the nucleotide sequence of SEQ ID NO: 8. A negative sense RNA virus that expresses the protein of SEQ ID NO: 7 may include a reverse complement and RNA version of a polynucleotide of SEQ ID NO: 8. A DNA virus or a positive sense RNA virus that expresses the protein of SEQ ID NO: 7 may include a polynucleotide of SEQ ID NO: 8. One example of such a negative sense RNA virus is a Maraba virus that includes the reverse complement and RNA version of SEQ ID NO: 9.

[0091] The protein "huSTEAP" or "human Six-Transmembrane Epithelial Antigen of the Prostate protein" according to the present disclosure is a protein that includes the amino acid sequence of SEQ ID NO: 10. This amino acid sequence may be encoded by the nucleotide sequence of SEQ ID NO: 11. A negative sense RNA virus that expresses the protein of SEQ ID NO: 10 may include a reverse complement and RNA version of a polynucleotide of SEQ ID NO: 11. A DNA virus or RNA virus that expresses the protein of SEQ ID NO: 10 may include a sequence that is SEQ ID NO: 11. One example of such a negative sense RNA virus is a Maraba virus that includes the reverse complement and RNA version of SEQ ID NO: 12.

[0092] The protein "NYESO1" or "human Cancer Testis Antigen 1" according to the present disclosure is a protein that includes the amino acid sequence of SEQ ID NO: 13. This amino acid sequence may be encoded by the nucleotide sequence of SEQ ID NO: 14. A negative sense RNA virus that expresses the protein of SEQ ID NO: 13 may include a reverse complement and RNA version of a polynucleotide of SEQ ID NO: 14. A DNA virus or RNA virus that expresses the protein of SEQ ID NO: 13 may include a sequence that is SEQ ID NO: 14. One example of such a negative sense RNA virus is a Maraba virus that includes the reverse complement and RNA version of SEQ ID NO: 15.

[0093] The above noted sequences are shown in Appendix A.

[0094] The term "mammal" refers to humans as well as non-human mammals. The term "cancer" is used herein to encompass any cancer that expresses the tumor associated antigenic protein (that is: MAGEA3, Human Papilloma Virus E6/E7 fusion protein, human Six-Transmembrane Epithelial Antigen of the Prostate protein, or Cancer Testis Antigen 1) used in the viruses of interest.

[0095] For example, when considering MAGEA3 as an antigenic protein, the term "cancer" encompasses any cancer that expresses MAGEA3 as an antigen. Examples of such

a cancer include, but are not limited to, melanoma, non-small cell lung cancer, head and neck cancer, colorectal cancer, and bladder cancer.

[0096] When considering E6/E7 fusion protein as an antigenic protein, the term "cancer" encompasses any cancer that expresses E6 and E7 proteins as antigenic proteins.

5 Examples of such a cancer include, but are not limited to, cervical cancer.

[0097] The first virus, the Maraba MG1 virus, or both may be independently administered to the mammal intravenously, intramuscularly, intraperitoneally, or intranasally. Following administration of the viruses, an immune response is generated by the mammal within an immune response interval, e.g. within about 4 days, and extending for months,
10 years, or potentially life.

[0098] The first virus may be any virus that induces an immune response to the tumor associated antigenic protein or variant thereof after the first virus is administered to the patient. Viruses that may be used according to the present disclosure include, for example: adenovirus (Ad), poxvirus, retrovirus, and alpha virus. An example of a poxvirus is vaccinia
15 virus. An example of a retrovirus is lentivirus. An example of an alpha virus is semliki forest virus.

[0099] To establish an immune response to the tumor associated antigenic protein or variant thereof, vaccination using the first virus and the Maraba MG1 virus may be conducted using well-established techniques. As one of skill in the art will appreciate, the amount of
20 virus required to generate an immune response will vary with a number of factors, including, for example, the selected antigen, the viral vector used to deliver the antigen, and the mammal to be treated, e.g. species, age, size, etc. In this regard, for example, intramuscular administration of at least about 10^7 PFU of Adenoviral vector to a mouse is sufficient to generate an immune response. A corresponding amount would be sufficient for
25 administration to a human to generate an immune response.

[00100] Once an immune response has been generated in the mammal by administration of the first virus, Maraba MG1 virus encoding the tumor associated antigenic protein or a variant thereof is administered in an amount suitable for oncolytic viral therapy within a suitable immune response interval. A suitable immune response interval may be, for
30 example, at least about 24 hours, preferably at least about 2-4 days or longer, e.g. at least about 1 week, or at least about 2 weeks. The amount of Maraba MG1 virus suitable for oncolytic viral therapy will vary with the mammal to be treated, as will be appreciated by one of skill in the art. For example, 10^8 PFU of Maraba MG1 virus encoding MAGEA3

administered IV to a mouse is sufficient for oncolytic therapy. A corresponding amount would be sufficient for use in a human.

[00101] Maraba MG1 virus encoding tumor associated antigenic protein or a variant thereof may be prepared by incorporating a reverse complement of a transgene encoding the tumor associated antigenic protein or a variant thereof into the Maraba MG1 virus using standard recombinant technology. For example, the reverse complement of the transgene may be incorporated into the genome of the Maraba MG1 virus, or alternatively, may be incorporated into the virus using a plasmid incorporating the transgene. The transgene encoding the tumor may be a codon optimized transgene.

10

EXAMPLES

[00102] The oncolytic Maraba MG1 is a potent oncolytic vaccine platform. While unable to prime detectable responses against a melanoma-associated antigen, Maraba MG1-vaccine displayed the ability to boost preexisting tumor-specific CD4⁺ and CD8⁺ T-cell immunity. When applied to the treatment of syngeneic murine melanoma tumor models, Maraba-MG1-mediated recall immunization resulted in an extension of the median survival with complete remission in more than 20% of the animals treated.

15

[00103] In a primate toxicity study heterologous prime-boost vaccination with an Ad-MAGEA3 prime followed by a Maraba-MG1-MAGEA3 boost resulted in T-cell responses that were comparable to those obtained in syngeneic murine tumour models demonstrating that in an outbred primate population the prime-boost oncolytic vaccine strategy gives immune responses comparable to animal models where tumours can be engrafted and a dramatic extension of survival is attained.

20

[00104] The authors of the present disclosure also determined that proteins having the sequence SEQ ID NOs: 7, 10, or 13 could be used to stimulate an immune response in a patient using a heterologous prime boost with Maraba MG1. In contrast, the authors of the present disclosure determined that administration of a first virus expressing EBDNA-1 protein or Placenta-specific protein 1 (PLAC-1) followed by administration of Maraba-MG1 expressing EBDNA-1 protein or PLAC-1, respectively, was unable to stimulate an immune response.

25

30

[00105] Example 1: MG1-hDCT is a Weak Priming Vector but a Potent Boosting Vector:

[00106] Ad-empty and Ad-hDCT are replication-deficient adenoviruses (E1/E3-deletion) based on the human serotype 5 (Lane C. et al., (2004) Cancer Research 64:1509-1514; Ng P. et al., (2001) Mol Ther 3:809-815). The replication-deficient adenovirus vector was engineered to express the hDCT transgene, which encodes the full length human melanoma associated antigen DCT (dopachrome tautomerase) while Ad-empty has no transgene. The resulting adenovirus vector is termed "Ad-hDCT".

[00107] The MG1 variant of Maraba virus was engineered to express the human form of the melanoma-associated antigen hDCT transgene. The resulting MG1 virus vector is termed "MG1-hDCT" or "Maraba MG1-hDCT". Other virus vectors are named using a similar convention.

[00108] Recombinant Maraba and VSV were generated by transgene insertion between the G and L viral genes. VSV-hDCT derives from the wild-type Indiana strain of the VSV (Bridle BW. et al. (2009) 17:1814-1821; Lawson ND. et al., (1995) Proc Natl Acad Sci USA 92:4477-4481). MG1-GFP (Green Fluorescent Protein used as a control non-immunogenic transgene insertion) and MG1-hDCT derive from the attenuated strain MG1 of Maraba virus. Prior to in vivo studies, DCT (and GFP) expression from the virus was confirmed by western blot of lysates from infected Vero cells cultured in alpha-MEM containing 10% FBS, 2 mM L-glutamine, 100 U/ml penicillin, and 100mg/ml streptomycin (all from Invitrogen, Grand Island, NY).

[00109] The therapeutic efficacy of MG1-hDCT administered as a monotherapy was evaluated initially. In order to generate lung metastases, C57Bl/6 mice (8-10 weeks old at study initiation) were injected i.v. with 2.5×10^5 B16-F10 cells (murine melanoma cells expressing the murine DCT antigen) in 200 μ l saline water. The oncolytic vaccine was injected systemically 5 or 14 days later and T-cell responses against the melanoma antigen DCT were measured in the blood at day 19. The virus was administered systemically at a high dose (10^9 pfu i.v in 200 μ l PBS). T-cell responses were measured by isolating PBMCs or splenocytes and stimulating them with the SVYDFFVWL (**SVY**) or KFFHRTCKCTGNFA (**KFF**) peptides corresponding to the MHC-I or MHC-II restricted immunodominant epitopes of DCT, respectively. Responding T-cells were detected after intracellular cytokine staining (ICS) for IFN- γ by flow cytometry.

[00110] As shown in Figs. 1A and 1B, MG1-hDCT was unable to prime DCT-specific CD8⁺ or CD4⁺ T-cell responses in tumor-bearing mice (Fig. 1A). Administered alone, the MG1-hDCT vaccine did not improve tumor outcome. Indeed, mice treated 14 days post-tumor challenge reached endpoint in a similar timeframe as untreated mice: after 20 days for the Ad-empty control group versus 21 days for the Ad-empty + MG1-hDCT group (Fig. 1B). Moreover, survival was not extended even when mice were treated with MG1-hDCT as early as 5 days after tumor engraftment (MG1-hDCT group, Fig. 1B). In conclusion, not only did MG1-hDCT fail to induce anti-DCT immunity but its oncolytic activity offered no therapeutic benefit. These results demonstrate that MG1-hDCT is unable to prime significant T-cell responses against the tumor antigen DCT and is thus a weak priming vector.

[00111] It was previously reported that an oncolytic VSV vector serves as a potent booster of pre-existing immunity (Bridle BW. et al., (2010) Mol Ther 184:4269-4275; WO 2010/105347). In the present disclosure, the ability of Maraba MG1 virus to serve as a booster vaccine was examined. Adenoviral vectors were used as priming vectors and administered intramuscularly (i.m.) at a total dose of 2×10^8 pfu (1×10^8 pfu in 50 μ l PBS per thigh). For adenovirus injection, mice were anesthetized in a sealed chamber containing 5% inhalation isoflurane. Using Ad-hDCT as a priming vector, MG1-hDCT was evaluated as a booster of pre-existing DCT-specific responses. To evaluate Maraba virus as a boosting vector, various routes of administration were evaluated. An oncolytic dose of 1×10^9 pfu of virus was administered that is well tolerated in this mouse strain and an interval of 12 days post-Ad priming was selected as this was the longest interval that would be feasible in the tumor model. When this dose of MG1-Maraba-hDCT was administered by intravenous (i.v.), intranasal (i.n.) and intramuscular (i.m.) routes, the i.v. route proved to be far superior as measured by ICS for IFN- γ in peripheral CD8⁺ T-cells: $28.33\% \pm 3.82$ by i.v. versus $4.73\% \pm 1.52$ i.n. versus $13.84\% \pm 1.88$ i.m. The responses were measured at day 5 post-Maraba administration coinciding with the peak of the MG1-hDCT-mediated boost response. In the intravenously boosted animals a significant proportion of DCT-specific CD8⁺ T-cells was also measured in the spleen with a 3-fold increase in mice administered with both vaccine vectors compared to animals primed only: $3.45\% \pm 0.45$ in Ad-hDCT group versus $11.02\% \pm 2.14$ in the Ad-hDCT + MG1-hDCT immunized animals ($p=0.0085^{**}$). While Ad-hDCT was unable to induce a detectable DCT-specific CD4⁺ T-cell population in the blood and a barely detectable population in the spleen, the MG1 Maraba-hDCT booster was able to generate clear systemic CD4⁺ T-cell response but only when administered i.v. ($0.30\% \pm 0.11$). The response

was also detectable in the spleen with $0.14\% \pm 0.03$ of splenic $CD4^+$ T-cells reacting to DCT KFF peptide exposure. Similar to VSV, maximal immune boosting by MG1 Maraba virus is achieved by i.v. administration. In conclusion, systemic delivery of a Maraba-vectored vaccine at a dose of 10^9 pfu appeared to allow for efficient boosting of both antigen-specific $CD8^+$ and $CD4^+$ T-cell populations. For this reason, this route and dose were used for Maraba MG1 administration in subsequent in vivo experiments.

[00112] To show that Maraba MG1-hDCT is a more potent boosting vector than VSV-hDCT, C57/Bl6 mice were primed with Ad-hDCT (Ad-BHG was included as a control vector lacking a transgene) and then boosted with an intravenous dose of either VSV-hDCT or Maraba-hDCT 14 days later. Immune analysis of $CD8^+$ T cell responses were measured in peripheral blood at day 5 post-boosting vector. At an equivalent dose the response induced by Maraba vaccination was 3-8 fold as large as the VSV-induced responses (Fig. 2).

[00113] Example 2: MG1-hDCT Vaccine Strategy in Murine Models of Cancer

[00114] The therapeutic efficacy of MG1-hDCT administered as a boosting vector was subsequently investigated. Five days following B16-F10 engraftment to generate lung metastases in animals, animals received an Ad-hDCT priming vaccine and this was followed 9 days later by a single i.v. dose of MG1 Maraba-hDCT as an oncolytic booster vaccine. Ad-hDCT prime-MG1-hDCT boost vaccination generated a very strong DCT-specific $CD8^+$ T-cell response (mean % $IFN-\gamma^+$ $CD8^+$ T-cells = 27.54 ± 2.17 , Fig. 3) that was 14 times higher than in non-boosted mice ($1.95\% \pm 0.29$ in Ad-hDCT group and $1.91\% \pm 0.59$ in Ad-hDCT + MG1-GFP group, Fig. 3). Similarly, DCT-specific $CD4^+$ T-cell responses were measured in MG1-hDCT boosted animals while rarely detected in primed only mice (mean % $IFN-\gamma^+$ $CD4^+$ T-cells = $0.25\% \pm 0.06$ in Ad-hDCT + MG1-hDCT group versus $<0.05\%$ in Ad-hDCT and Ad-hDCT + MG1-GFP groups, fig. 3).

[00115] Looking at treatment outcome, Ad-hDCT immunization allowed a 10-day extension of the median survival compared to untreated mice: 31 days for Ad-hDCT treatment versus 20.5 days for Ad-empty group (Fig. 4). Ad-hDCT treatment followed by MG1 Maraba-GFP oncolytic treatment did not improve survival (27.5 days median survival for Ad-hDCT + MG1-GFP group, Fig. 4). However, boosting anti-tumor immunity with the Maraba MG1-DCT vaccine dramatically improved tumor outcome with a 20-day extension of the median survival compared to Ad-hDCT primed only animals (51 days for Ad-hDCT +

MG1-hDCT group, Fig. 4). More importantly, the oncolytic MG1-hDCT booster treatment resulted in 23.3% long-term survival (Fig. 4).

[00116] In order to characterize the respective contribution of tumor-specific CD4⁺ and CD8⁺ T-cell responses in the therapeutic efficacy, each T-cell compartment was selectively depleted (data not shown). Depletion of the CD8⁺ T-cell population at the time of the boost abrogated the therapeutic benefit of MG1-hDCT administration. On the contrary, CD4⁺ T-cells depletion appeared not to affect significantly the therapeutic efficacy indicating that Maraba immune boosting of CD8⁺ T cells is CD4⁺-independent. While the critical role of CD8⁺ T-cells in controlling tumor growth is admitted, these results show that boosting tumor-specific CD8⁺ T-cells with Maraba vaccine is a potent way of improving cancer therapy.

[00117] Finally, the efficacy of the prime-boost strategy involving Maraba vaccine was also evaluated in a very challenging intracranial B16-F10 model of metastatic melanoma brain cancer. Ad-hDCT-mediated immunotherapy significantly improved survival of melanoma brain met-bearing mice with a median extended from 15 days for Ad-empty controls to 25.5 days for the Ad-hDCT group (Fig. 5). As previously reported, such therapeutic efficacy demonstrates the ability of the tumor-specific effector T-cells raised to cross the blood-brain barrier and infiltrate the tumor bed (Bridle BW. et al., (2010) Mol Ther 184:4269-4275). The additional administration of a Maraba MG1-hDCT oncolytic booster further improved tumor outcome with a median survival reaching 42 days together with cures observed in 21.4% of treated animals (Ad-hDCT + MG1-hDCT group, Fig. 5).

[00118] Example 3: Failure of Vaccine Strategy to induce an anti-mPLAC1 T Cell Response:

[00119] Although Maraba MG1 and VSV were able to act as boosting vectors using hDCT as a tumor associated antigen, not all tumor associated antigens can be used in a heterologous prime-boost vaccine strategy. The authors of the present disclosure tested a heterologous prime-boost vaccine strategy using huAd5-mPLAC1 as the priming vector and VSV-mPLAC1 as the boosting vector.

[00120] PLAC1 is a recently described tumor associated antigen expressed in the placenta but has also been reported in several tumour cell lines and in tumours of patients breast, lung, liver, gastric and colorectal cancers (Silva, WA et al., (2007) Cancer Immun 7:18).

[00121] Ad-mPLAC1 is a replication-deficient adenoviruses (E1/E3-deletion) based on the human serotype 5 (Lane C. et al., (2004) Cancer Research 64:1509-1514; Ng P. et al., (2001) Mol Ther 3:809-815). The replication-deficient adenovirus vector was engineered to express the mPLAC1 transgene, which encodes the full length murine antigen PLAC1 (placenta-specific 1), the resulting adenovirus vector is termed "Ad-mPLAC1" or "huAd5-mPLAC1".

[00122] VSV virus was engineered to express the human form of the melanoma-associated antigen mPLAC1 transgene. The resulting VSV virus vector is termed "VSV-mPLAC1". Recombinant VSV was generated by transgene insertion between the G and L viral genes. VSV-mPLAC1 derives from the wild-type Indiana strain of the VSV (Bridle BW. et al. (2009) 17:1814-1821; Lawson ND. et al., (1995) Proc Natl Acad Sci USA 92:4477-4481).

[00123] C57Bl/6 mice were primed with Ad-mPLAC1 (2×10^9 PFU IM injection) and then boosted with a single i.v. dose of VSV-mPLAC1 (2×10^9 PFU) 14 days later. T-cell responses were measured by isolating splenocytes and stimulating them with individual 15mer peptides from an overlapping PLAC1 peptide library for a total of 6 hours with golgi plug added 1 hour into the stimulation. Following stimulation the splenocytes were stained for CD4, CD8 and IFN γ and analyzed on FACSCanto and FlowJo. Responding T-cells were detected after intracellular cytokine staining (ICS) for IFN- γ by flow cytometry. None of the mPLAC1 peptides were able to stimulate IFN- γ production in either CD8 or CD4 T cells.

[00124] **Example 4: Construction of Oncolytic Vaccine Vectors with MAGEA3 or a variant thereof:**

[00125] Ad-MAGEA3 is a replication-deficient adenovirus (E1/E3-deletion) based on the human serotype 5 (Lane C. et al., (2004) Cancer Research 64:1509-1514; Ng P. et al., (2001) Mol Ther 3:809-815) containing the full-length human MAGEA3 gene. Maraba MG1-hMAGEA3 has been developed and contains the codon-optimized full length human MAGEA3 gene inserted between the G and L viral genes of the MG1 double mutant of Maraba virus (Brun J. et al., (2010) Mol Ther 18:1440-1449). The MAGEA3 sequence (NCBI Gene ID: 4102 <http://www.ncbi.nlm.nih.gov/gene/4102>) was codon optimized for expression in mammalian cells and then synthesized with a FLAG tag on 3' end and with MluI restriction sites on both 3' and 5' ends. This sequence was ligated into the shuttle vector pMRB-MG1/pNF at its MluI site (between G and L genes) which contains part of the Maraba-MG1 genome from the beginning of G to the end of L genes, flanked by KpnI and NheI sites,

respectively. The entire region from KpnI to NheI, now containing MAGEA3 Flag between G and L was then removed from pMRB-MG1/pNF and ligated back into the pMRB-MG1 genomic plasmid using KpnI and NheI sites. Maraba-MG1-MAGEA3 Flag was then rescued and plaque purified. This is illustrated in Figure 6.

5 **[00126]** A full length human MAGEA3 protein expressed by the adenovirus may include the amino acid sequence of SEQ ID NO: 1. The adenovirus may include a nucleotide sequence of SEQ ID NO: 2. Alternatively, the amino acid sequence may be encoded by a codon optimized transgene that includes the nucleotide sequence of SEQ ID NO: 3. Accordingly, the adenovirus may include the codon-optimized nucleotide sequence of SEQ
10 ID NO: 3.

[00127] The Maraba MG1 virus may include a reverse complement and RNA version of a nucleotide sequence of SEQ ID NO: 2. Alternatively, the amino acid sequence may be encoded by a codon optimized transgene that includes the nucleotide sequence of SEQ ID NO: 3. Accordingly, the Maraba MG1 virus may include the reverse complement and RNA
15 version of the codon-optimized nucleotide sequence of SEQ ID NO: 3.

[00128] One variant of MAGEA3 is a protein that includes the amino acid sequence of SEQ ID NO: 4. This amino acid sequence may be encoded by the nucleotide sequence of SEQ ID NO: 5. The adenovirus may include a nucleotide sequence of SEQ ID NO: 5. The Maraba MG1 virus may include a reverse complement and RNA version of a nucleotide
20 sequence of SEQ ID NO: 5.

[00129] A negative sense RNA virus, such as a Maraba virus, that expresses the protein of SEQ ID NO: 4 may include an RNA polynucleotide which includes a sequence that is a reverse complement and RNA version of SEQ ID NO: 6.

25 **[00130]** **Example 5: MG1-MAGEA3 Vaccine Immune Response in Healthy Primates:**

[00131] Healthy cynomolgous monkeys were used in a study designed to collect toxicity and immunogenicity data for developing the potential MG1-MAGEA3 oncolytic vaccine for human use. The use of the cynomolgous monkeys maximizes the likelihood of
30 identifying responses that are quantitatively and qualitatively similar to those expected in humans. Prior to study start primates were acclimated for 4-6 weeks from the time of animal arrival until the time of vascular access port implantation surgery. After a minimum of 2-3 weeks following surgery, animals were vaccinated with a non-replicating adenovirus Ad-

MAGEA3 priming vector, injected in each leg, 0.5 mL per dose totaling 1×10^{10} pfu by slow IM injection. For the Ad-MAGEA3/MG1-MAGEA3 prime boost study, Ad-MAGEA3 prime occurred at either 2 weeks (-14 days) or 4 weeks (-28 days) prior to MG1-MAGEA3 boost. Therefore Ad-MAGEA3 administration occurred on Day -14 or on Day -28 and MG1-MAGEA3 boost on Days 0 and 3. The rationale for Ad-MAGEA3 dosage level comes from the literature, and from previous experiments demonstrating that a dose of 1×10^{10} pfu in Macaques (and humans) is a safe dose with no observed toxicities (Bett et al. Vaccine, 2010). For animals in the 2 week boosted group, MG1-MAGEA3 virus was injected i.v. at either a low dose 1×10^{10} or a high dose 1×10^{11} at experiment days 0 and 3 (14 and 17 days after Ad-MAGEA3). For animals in the 4 week boosted group, MG1-MAGEA3 virus was injected i.v. at either a low dose 1×10^{10} or a high dose 1×10^{11} at experiment days 0 and 3, (28 and 31 days after the Ad-MAGEA3). Boosting Virus was infused in 30 mL of sterile buffered saline (pH 7.5) over 30 minutes through the vascular access port. The rationale for MG1-MAGEA3 low dosage level comes from pre-clinical studies that demonstrate that the murine maximum tolerable dose is 1×10^9 . The relative body surface area scale-up to Macaques equates this to 3.5×10^{10} total pfu. The rationale for MG1-MAGEA3 high dosage level comes from a pilot Non-Human Primate (NHP) toxicology study, where there was no observed toxicity at a dose level of 2×10^{11} pfu. Animals in the prime boost study were either sacrificed early (Day 14) or late (Day 84). For the Ad-MAGEA3/MG1-MAGEA3 prime boost study, blood samples were taken from all animals at 5 distinct time points. For animals in the 2 week heterologous prime-boost cohort, blood samples were collected prior to any vaccination and on a day prior to Day -14 (Baseline) and on experiment Days 5, 13 and 84. For animals in the 4 week heterologous prime-boost cohort, blood samples were collected prior to any vaccination and on a day prior to Day -28 (Baseline), and on experiment Days 5, 13, and 84.

[00132] To assess immune responses in the primates to the heterologous prime-boost vaccination with Ad-MAGEA3/MG1-MAGEA3, Peripheral Blood Mononuclear Cells (PBMCs) were incubated for 4 hours (last 3 hours in presence of Brefeldin A) with a pool of 10 hMAGE-A3 peptides for T-cell (re-) stimulation (or left unstimulated for evaluation of the background). Peptides were from an overlapping peptide library covering the whole hMAGE-A3 antigen from N to C-termini in 87 peptides (15-mer each). After stimulation, T-cells were stained with fluorescent anti-CD8 and anti-CD4 antibodies for 25 minutes. After this surface staining, cells were permeabilized and fixed with BD Cytotfix/Cytoperm for 20 minutes. Then,

hMAGE-A3-specific T-cells were detected by looking at cytokine expression by intracellular staining with fluorescent anti-IFN γ and anti-TNF α antibodies for 25 minutes. Cell analysis was performed on BD Canto flow cytometer.

[00133] Figure 7 shows the average CD8⁺ T-cell immune responses of monkeys given high and low dose MG1-MAGEA3 as a boosting vector following an Ad-MAGEA3 prime. In the low dose MG1-MAGEA3 animals there is a significant increase in CD8⁺ T-cell response 5 days following the boost, which drops off over time while in the high dose MG1-MAGEA3 animals there is a similar significant increase in CD8⁺ T-cell response 5 days following the boost, which is sustained at a higher level over time. Figure 8 shows that all of the animals in the study exhibited a significant increase in CD8⁺ T-cell response 5 days following the boost with MG1-MAGEA3 irrespective of high or low dose. These peak T-cell responses in Primates demonstrate that in an outbred population the prime-boost oncolytic vaccine strategy gives immune responses comparable to animal models where tumours can be engrafted and a dramatic extension of survival is attained.

15

[00134] Example 6: Construction and Immune Testing of Lentiviral Priming Vectors and Oncolytic Vaccine Vectors expressing Human Papilloma Virus E6/E7 fusion protein:

[00135] The HPV transgene is a fusion of HPV serotype 16 full-length wild-type E6 (gi/4927720/gb/AAD33252.1/AF125673_1 E6 Human papillomavirus type 16) and E7 (gi/4927721/gb/AAD33253.1/AF125673_2 E7 Human papillomavirus type 16) sequences and HPV serotype 18 full-length wild-type E6 (gi/137758/sp/P06463.1/VE6_HP18 RecName: Full=Protein E6) and E7 (gi/137792/sp/P06788.2/VE7_HP18 RecName: Full=Protein E7) sequences with deletions in all 4 nucleotide sequences to remove zinc fingers required for Rb or p53 binding (removing oncogenic potential of the proteins). The resulting fusion protein has a flexible glycine linker plus AAY sequence (which serves as a proteasomal cleavage site to ensure that each antigen is proteolytically degraded to the peptides normally generated for antigen presentation). This codon-optimized fusion nucleotide sequence gives rise to a 527 amino acid HPV16/18 E6/E7 fusion protein (SEQ ID NO: 7).

30

[00136] Lentiviruses expressing Human Papilloma Virus E6/E7 fusion transgene were made using the pDY.EG.WS lentivirus vector. The modified HPV transgene was PCR amplified using primers containing the EcoRI restriction site (forward primer

ACTGGAATTCATGCATCAGAAGCGAACTGC, SEQ ID NO: 18) and the BamHI restriction site (reverse primer ACTGGGATCCTCACTGCTGGGAGGCACAC, SEQ ID NO: 19). The HPV transgene PCR product was agarose gel purified. The pDY.EG.WS lentivirus vector was cut at the EcoRI and BamHI sites to remove eGFP, was agarose gel purified, and was
5 subjected to dephosphorylation using CIAP (Invitrogen Catalogue 18009-019). The cut vector was then subjected to additional agarose gel purification. The HPV transgene PCR product was then ligated into the EcoRI/BamHI cut vector using T4 DNA ligase (Invitrogen). The ligation reaction was subjected to a transformation using competent cells, and plasmid DNA from positive colonies was subjected to mini-prep amplification. The pDY.EG.WS
10 lentivirus vector expressing the modified HPV transgene was then subjected to maxi-prep amplification. The lentivirus expressing Human Papilloma Virus E6/E7 fusion transgene were rescued on 293T cells after transfection of 6.4 µg of each of three plasmids: the pDY.EG.WS lentivirus vector expressing the modified HPV transgene, the packaging pCMV-8.84 plasmid, and the envelope pMD2G plasmid. Virus supernatants were pooled, and filtered through a
15 0.45 µM filter and centrifuged for 120 minutes at 50,000 x g at 16°C. The lentivirus expressing Human Papilloma Virus E6/E7 fusion transgene was resuspended in PBS, and stored at -80°C.

[00137] Maraba MG1 was engineered to contain a Papilloma Virus E6/E7 fusion transgene inserted between the G and L viral genes of the MG1 double mutant of Maraba
20 virus (Brun J. et al., (2010) Mol Ther 18:1440-1449). The transgene sequence (SEQ ID NO: 8) was codon optimized for expression in mammalian cells. The resulting Maraba MG1 containing the HPV E6/E7 is designated, generally, "Maraba-MG1- HPV E6/E7". A modified Maraba MG1 backbone was used to facilitate cloning. A silent mutation was introduced into the L gene of the Maraba MG1 genome backbone to remove one of the Mlul sites. The
25 second Mlul site was replaced with a BsiWI site at the cloning region between G and L. These modifications to the Maraba MG1 genome backbone allowed for a more direct cloning system than that described in the Brun et al. paper as it avoids using the shuttle plasmid pMRB-MG1/pNF. The HPV E6/E7 fused transgene sequence was ligated into the modified Maraba MG1 genome backbone at its Mlul site and BsiWI site (at cloning region between G
30 and L) The Maraba-MG1-HPV E6/E7 was then rescued (as previously described in Brun et al., (2010) Mol Ther 18:1440-1449), plaque purified once, and subjected to opti-prep

purification.). The Maraba-MG1-HPV E6/E7 has a genomic sequence that is the reverse complement and RNA version of SEQ ID NO: 9.

[00138] Generally, animals were immunized by administration of the priming vector (lentivirus-HPV E6/E7 + poly I:C as an adjuvant) at day 0 and by administration of 1e9 PFU of the boosting vector (Maraba-MG1-HPV E6/E7) at day 14. Control animals were prime-boosted with viral vectors encoding GFP instead of the HPV E6/E7 transgene as a control non-immunogenic transgene insertion. Analysis of the prime response was conducted at day 14 and of the boost response at day 19. Each lentivirus-HPVE6/E7 preparation was made with 250 ug poly I:C added as an adjuvant to the priming virus and then split between 5 animals for each virus. Mice were anesthetized with isoflurane and 30uL of lentivirus-HPV E6/E7/poly I:C was injected into each hind foot pad. The remaining virus was injected subcutaneously near the left inguinal lymph node. 14 days after prime, blood was collected and analyzed by flow cytometry. Mice were then boosted with 1×10^9 PFU MG1-HPV E6/E7 intravenously. 5 days following the boost, blood was drawn and immune responses were assessed by flow cytometry.

[00139] Immune analysis was performed as follows: Blood was collected via retro-orbital bleeding using heparinized capillary tube and blood was collected into heparin. Red blood cells were then lysed using ACK lysis buffer and the resulting PBMCs were analyzed for immune responses to the tumour antigens. PBMCs were either incubated in the absence of peptide or stimulated with 2 ug/mL peptides (RAHYNIVTF) for a total of 5 hours with golgi plug added 1 hour into the stimulation. Following stimulation the PBMCs were stained for CD4, CD8 and IFN γ and analyzed on FACSCanto and FlowJo. Responding T-cells were detected after intracellular cytokine staining (ICS) for IFN- γ by flow cytometry. Values from unstimulated PBMCs were considered background and subtracted from values obtained from stimulated PBMCs. Data represents mean +/- SEM. In Table 1 it is demonstrated that the HPV E6/E7 peptides were able to stimulate IFN- γ production in CD8 cells indicating the existence of an immune response.

Table 1. IMMUNE RESPONSE to HPV E6/E7 PRIME-BOOST

Stimulatory Peptide Epitope	Percentage of CD8 T Cells Secreting Interferon (IFN) γ			
	Control Group Lentivirus-GFP Prime MG1-GFP Boost		Immune Group Lentivirus- HPV E6/E7 Prime MG1- HPV E6/E7 Boost (N=5)	
RAHYNIVTF	0.0033 \pm 0.0033 (after prime)	0.03 \pm 0.025 (after boost)	0.036 \pm 0.012 (after prime)	5.9 \pm 2.7 (after boost)

[00140] Example 7: Construction and Immune Testing of Lentiviral Priming Vectors and Oncolytic Vaccine Vectors expressing Cancer Testis Antigen 1:

5 **[00141]** The NYESO1 transgene is full-length wild-type sequence (SEQ ID NO: 14) codon-optimized for expression in human and mouse to give rise to a 180 amino acid protein (SEQ ID NO: 13).

[00142] Lentiviruses expressing Cancer Testis Antigen 1 transgene were made using the pDY.EG.WS lentivirus vector. The NYESO1 transgene was PCR amplified using primers
10 containing the BamHI restriction site (forward primer ACTGGGATCCATGCAGGCCGAGGGCAGAG, SEQ ID NO: 20) and the BamHI restriction site (reverse primer ACTGGGATCCTCATCTTCTCTGGCCGCTGG, SEQ ID NO: 21). The NYESO1 transgene PCR product was agarose gel purified. The pDY.EG.WS lentivirus vector was cut at the BamHI site to remove eGFP, was agarose gel purified, and was
15 subjected to dephosphorylation using CIAP (Invitrogen Catalogue 18009-019). The cut vector was then subjected to additional agarose gel purification. The NYESO1 transgene PCR product was then ligated into the BamHI cut vector using T4 DNA ligase (Invitrogen). The ligation reaction was subjected to a transformation using competent cells, and plasmid DNA from positive colonies was subjected to mini-prep amplification. The pDY.EG.WS
20 lentivirus vector expressing the modified HPV transgene was then subjected to maxi-prep amplification. The lentivirus expressing NYESO1 transgene were rescued on 293T cells after transfection of 6.4 μ g of each of three plasmids: the pDY.EG.WS lentivirus vector expressing the NYESO1 transgene, the packaging pCMV-8.84 plasmid, and the envelope pMD2G plasmid. Virus supernatants were pooled, and filtered through a 0.45 μ M filter and

centrifuged for 120 minutes at 50,000 x g at 16°C. The lentivirus expressing NYESO1 transgene was resuspended in PBS, and stored at -80°C.

[00143] Maraba MG1 was engineered to contain Cancer Testis Antigen 1 transgene inserted between the G and L viral genes of the MG1 double mutant of Maraba virus (Brun J. et al., (2010) Mol Ther 18:1440-1449). The transgene sequence was codon optimized for expression in mammalian cells. The resulting Maraba MG1 containing the NYESO1 protein is designated as "Maraba-MG1-NYESO1" or "MG1-NYESO1".

[00144] The NYESO1 transgene was ligated into the shuttle vector pMRB-MG1/pNF at its MluI site (between G and L genes) which contains part of the Maraba-MG1 genome from the beginning of G to the end of L genes, flanked by KpnI and NheI sites, respectively. The entire region from KpnI to NheI, now containing the NYESO1 transgene inserted between G and L was then removed from pMRB-MG1/pNF and ligated back into the pMRB-MG1 genomic plasmid using KpnI and NheI sites. The Maraba-MG1-NYESO1 was then rescued (as previously described Brun J. et al., (2010) Mol Ther 18:1440-1449). The Maraba-MG1-NYESO1 was plaque purified 3 times, and purified via sucrose cushion purification. The Maraba-MG1-NYESO1 virus has a genomic sequence that is the reverse complement and RNA version of SEQ ID NO: 15.

[00145] Generally, animals were immunized by administration of the priming vector (lentivirus-NYESO1 + poly I:C as an adjuvant) at day 0 and by administration of 1e9 PFU of the boosting vector (Maraba-MG1-NYESO1) at day 14. Control animals were prime-boosted with viral vectors encoding GFP instead of the NYESO1 transgene as a control non-immunogenic transgene insertion. Analysis of the prime response was conducted at day 14 and day 19. Each lentivirus-NYESO1 preparation was made with 250 ug poly I:C added as an adjuvant to the priming virus and then split between 5 animals for each virus. Mice were anesthetized with isoflurane and 30uL of lentivirus-NYESO1/poly I:C was injected into each hind foot pad. The remaining virus was injected subcutaneously near the left inguinal lymph node. 14 days after prime, blood was collected and analyzed by flow cytometry. Mice were then boosted with 1x10⁹ PFU MG1-NYESO1 intravenously. Five days following the boost, blood was drawn and immune responses were assessed by flow cytometry.

[00146] Immune analysis was performed as follows: Blood was collected via retro-orbital bleeding using heparinized capillary tube and blood was collected into heparin. Red blood cells were then lysed using ACK lysis buffer and the resulting PBMCs were analyzed

for immune responses to the tumour antigens. PBMCs were either incubated in the absence of peptide or stimulated with 2 ug/mL peptides (RGPESRLL) for a total of 5 hours with golgi plug added 1 hour into the stimulation. Following stimulation the PBMCs were stained for CD4, CD8 and IFN γ and analyzed on FACSCanto and FlowJo. Responding T-cells were

5 detected after intracellular cytokine staining (ICS) for IFN- γ by flow cytometry. Values from unstimulated PBMCs were considered background and subtracted from values obtained from stimulated PBMCs. Data represents mean +/- SEM. In Table 2 it is demonstrated that the NYESO1 peptides were able to stimulate IFN- γ production in CD8 cells indicating the

existence of an immune response.

10

Table 2. IMMUNE RESPONSE to NYESO1 PRIME-BOOST

Stimulatory Peptide Epitope	Percentage of CD8 T Cells Secreting Interferon (IFN) γ			
	Control Group Lentivirus-GFP Prime MG1-GFP Boost		Immune Group Lentivirus- NYESO1 Prime MG1- NYESO1 Boost (N=5)	
RGPESRLL	0 \pm 0 (after prime)	0.013 \pm 0.0088 (after boost)	0.027 \pm 0.015 (after prime)	12.33 (after boost)

[00147] Example 8: Construction and Immune Testing of Lentiviral Priming Vectors and Oncolytic Vaccine Vectors expressing human Six-Transmembrane Epithelial Antigen of the Prostate protein:

15 **[00148]** The huSTEAP transgene is full-length wild-type sequence (SEQ ID NO: 11) codon-optimized for expression in human and mouse to give rise to a 341 amino acid protein (SEQ ID NO: 10).

[00149] Lentiviruses expressing human Six-Transmembrane Epithelial Antigen of the Prostate protein were made using the pDY.EG.WS lentivirus vector. The huSTEAP

20 transgene was PCR amplified using primers containing the EcoRI restriction site (forward primer ACTGGAATTCATGGAATCACGGAAGGACATC, SEQ ID NO: 22) and the BamHI restriction site (reverse primer ACTGGGATCCTTAAAGCTTCAGCTGGCTACAG, SEQ ID NO: 23). The huSTEAP transgene PCR product was agarose gel purified. The pDY.EG.WS lentivirus vector was cut at the EcoRI/BamHI site to remove eGFP, was agarose gel purified,

and was subjected to dephosphorylation using CIAP (Invitrogen Catalogue 18009-019). The cut vector was then subjected to additional agarose gel purification. The huSTEAP transgene PCR product was then ligated into the EcoRI/BamHI cut vector using T4 DNA ligase (Invitrogen). The ligation reaction was subjected to a transformation using competent cells, and plasmid DNA from positive colonies was subjected to mini-prep amplification. The pDY.EG.WS lentivirus vector expressing the modified huSTEAP transgene was then subjected to maxi-prep amplification. The lentivirus expressing huSTEAP transgene were rescued on 293T cells after transfection of 6.4 µg of each of three plasmids: the pDY.EG.WS lentivirus vector expressing the huSTEAP transgene, the packaging pCMV-8.84 plasmid, and the envelope pMD2G plasmid. Virus supernatants were pooled, and filtered through a 0.45 µM filter and centrifuged for 120 minutes at 50,000 x g at 16°C. The lentivirus expressing huSTEAP transgene was resuspended in PBS, and stored at -80°C.

[00150] Maraba MG1 was engineered to contain human Six-Transmembrane Epithelial Antigen of the Prostate transgene inserted between the G and L viral genes of the MG1 double mutant of Maraba virus (Brun J. et al., (2010) Mol Ther 18:1440-1449). The transgene sequence was codon optimized for expression in mammalian cells. The resulting Maraba MG1 containing the huSTEAP protein is designated as “Maraba-MG1-huSTEAP” or “MG1-huSTEAP”. A modified Maraba MG1 backbone was used to facilitate cloning. A silent mutation was introduced into the L gene of the Maraba MG1 genome backbone to remove one of the Mlul sites. The second Mlul site was replaced with a BsiWI site at the cloning region between G and L. These modifications to the Maraba MG1 genome backbone allowed for a more direct cloning system than that described in the Brun et al. paper as it avoids using the shuttle plasmid pMRB-MG1/pNF. The huSTEAP transgene sequence was ligated into the modified Maraba MG1 genome backbone at its Mlul and BsiWI site (at cloning region between G and L). The Maraba-MG1-huSTEAP was then rescued (as previously described in Brun J. et al., (2010) Mol Ther 18:1440-1449), plaque purified once, and subjected to opti-prep purification. The Maraba-MG1-huSTEAP has a genomic sequence that is the reverse complement and RNA version of SEQ ID NO: 12.

[00151] Generally, animals were immunized by administration of the priming vector (lentivirus-huSTEAP + poly I:C as an adjuvant) at day 0 and by administration of 1e9 PFU of the boosting vector (Maraba-MG1-huSTEAP) at day 14. Control animals were prime-boosted with viral vectors encoding GFP instead of the huSTEAP transgene as a control non-

immunogenic transgene insertion. Analysis of the prime response was conducted at day 14 and day 19. Each lentivirus-huSTEAP preparation was made with 250 ug poly I:C added as an adjuvant to the priming virus and then split between 5 animals for each virus. Mice were anesthetized with isoflurane and 30uL of lentivirus-huSTEAP/poly I:C was injected into each hind foot pad. The remaining virus was injected subcutaneously near the left inguinal lymph node. 14 days after prime, blood was collected and analyzed by flow cytometry. Mice were then boosted with 1×10^9 PFU MG1-huSTEAP intravenously. Five days following the boost, blood was drawn and immune responses were assessed by flow cytometry.

[00152] Immune analysis was performed as follows: Blood was collected via retro-orbital bleeding using heparinized capillary tube and blood was collected into heparin. Red blood cells were then lysed using ACK lysis buffer and the resulting PBMCs were analyzed for immune responses to the tumour antigens. PBMCs were either incubated in the absence of peptide or stimulated with peptides for a total of 5 hours with golgi plug added 1 hour into the stimulation. PBMCs were either incubated in the absence of peptide or stimulated with 2 ug/mL peptides (RSRYKLL) for a total of 5 hours with golgi plug added 1 hour into the stimulation. Following stimulation the PBMCs were stained for CD4, CD8 and IFN γ and analyzed on FACSCanto and FlowJo. Responding T-cells were detected after intracellular cytokine staining (ICS) for IFN- γ by flow cytometry. Values from unstimulated PBMCs were considered background and subtracted from values obtained from stimulated PBMCs. Data represents mean +/- SEM. In Table 3 it is demonstrated that the huSTEAP peptides were able to stimulate IFN- γ production in CD8 cells indicating the existence of an immune response.

Table 3. IMMUNE RESPONSE to huSTEAP PRIME-BOOST

Stimulatory Peptide Epitope	Percentage of CD8 T Cells Secreting Interferon (IFN) γ			
	Control Group Lentivirus-GFP Prime MG1-GFP Boost		Immune Group Lentivirus- huSTEAP Prime MG1- huSTEAP Boost (N=5)	
RSYRYKLL	0.0033 \pm 0.0033 (after prime)	0.0033 \pm 0.0033 (after boost)	0.008 \pm 0.0508 (after prime)	0.406 \pm 0.11 (after boost)

[00153] Example 9: Construction and Immune Testing of Lentiviral Priming Vectors and Oncolytic Vaccine Vectors expressing Epstein-Barr Nuclear Antigen 1:

[00154] The EBDNA1 transgene is a partial nucleotide sequence of full-length wild-type EBDNA1 (<http://www.ncbi.nlm.nih.gov/protein/Q1HVF7.1>) with the Glycine-Alanine

5 generating repetitive sequence deleted (which separates the protein into amino- and carboxy-terminal domains). This sequence seems to stabilize the protein, preventing proteasomal breakdown, as well as impairing antigen processing and MHC class I-restricted antigen presentation (Levitskaya J et al., (1995) Nature 375:685-688). The truncated EBDNA1 nucleotide sequence (SEQ ID NO: 17) was codon-optimized for expression in

10 human and mouse to give rise to a 238 amino acid protein (SEQ ID NO: 16).

[00155] Lentiviruses expressing Epstein-Barr Nuclear Antigen 1 protein were made using the pDY.EG.WS lentivirus vector. The modified EBDNA1 transgene was PCR amplified using primers containing the EcoRI restriction site (forward primer

15 ACTGGAATTCATGCCAGTCGGCCAGGCTG, SEQ ID NO: 24) and the BamHI restriction site (reverse primer ACTGGGATCCTTATTCTGCCCTCTTCTCC, SEQ ID NO: 25). The EBDNA1 transgene PCR product was agarose gel purified. The pDY.EG.WS lentivirus vector was cut at the EcoRI and BamHI sites to remove eGFP, was agarose gel purified, and was subjected to dephosphorylation using CIAP (Invitrogen Catalogue 18009-019). The cut vector was then subjected to additional agarose gel purification. The EBDNA1 transgene

20 PCR product was then ligated into the EcoRI/BamHI cut vector using T4 DNA ligase (Invitrogen). The ligation reaction was subjected to a transformation using competent cells, and plasmid DNA from positive colonies was subjected to mini-prep amplification. The pDY.EG.WS lentivirus vector expressing the EBDNA1 transgene was then subjected to maxi-prep amplification. The lentivirus expressing EBDNA1 transgene was rescued on 293T

25 cells after transfection of 6.4 µg of each of three plasmids: the pDY.EG.WS lentivirus vector expressing the EBDNA1 transgene, the packaging pCMV-8.84 plasmid, and the envelope pMD2G plasmid. Virus supernatants were pooled, and filtered through a 0.45 µM filter and centrifuged for 120 minutes at 50,000 x g at 16°C. The lentivirus expressing EBDNA1 transgene was resuspended in PBS, and stored at -80°C.

30 **[00156]** Maraba MG1 was engineered to contain Epstein-Barr Nuclear Antigen 1 transgene inserted between the G and L viral genes of the MG1 double mutant of Maraba virus (Brun J. et al., (2010) Mol Ther 18:1440-1449). The transgene sequence was codon

optimized for expression in mammalian cells. The resulting Maraba MG1 containing the EBVDNA1 protein is designated as “Maraba-MG1-EBVDNA1” or “MG1-EDVDNA1”. A modified Maraba MG1 backbone was used to facilitate cloning. A silent mutation was introduced into the L gene of the Maraba MG1 genome backbone to remove one of the MluI sites. The second MluI site was replaced with a BsiWI site at the cloning region between G and L. These modifications to the Maraba MG1 genome backbone allowed for a more direct cloning system than that described in the Brun et al. paper as it avoids using the shuttle plasmid pMRB-MG1/pNF. The EBDNA1 transgene sequence was ligated into the modified Maraba MG1 genome backbone at its MluI and BsiWI site (at cloning region between G and L). The Maraba-MG1-EBDNA1 transgene was then rescued (as previously described in Brun J. et al., (2010) Mol Ther 18:1440-1449), plaque purified once, and subjected to opti-prep purification.

[00157] Generally, animals were immunized by administration of the priming vector (lentivirus-EBDNA1 + poly I:C as an adjuvant) at day 0 and by administration of 1e9 PFU of the boosting vector (Maraba-MG1-EBDNA1) at day 14. Control animals were prime-boosted with viral vectors encoding GFP instead of the TAA transgene as a control non-immunogenic transgene insertion. Analysis of the prime response was conducted at day 14 and day 19. Each lentivirus-EBDNA1 preparation was made with 250 ug poly I:C added as an adjuvant to the priming virus and then split between 5 animals for each virus. Mice were anesthetized with isoflurane and 30uL of lentivirus-EBDNA1/poly I:C was injected into each hind foot pad. The remaining virus was injected subcutaneously near the left inguinal lymph node. 14 days after prime, blood was collected and analyzed by flow cytometry. Mice were then boosted with 1×10^9 PFU MG1-EBVDNA1 intravenously. Five days following the boost, blood was drawn and immune responses were assessed by flow cytometry.

[00158] Immune analysis was performed as follows: Blood was collected via retro-orbital bleeding using heparinized capillary tube and blood was collected into heparin. Red blood cells were then lysed using ACK lysis buffer and the resulting PBMCs were analyzed for immune responses to the tumour antigens. PBMCs were either incubated in the absence of peptide or stimulated with 2 ug/mL peptides (VYGGSKTSL) for a total of 5 hours with golgi plug added 1 hour into the stimulation. Following stimulation the PBMCs were stained for CD4, CD8 and IFN γ and analyzed on FACSCanto and FlowJo. Responding T-cells were detected after intracellular cytokine staining (ICS) for IFN- γ by flow cytometry. Values from

unstimulated PBMCs were considered background and subtracted from values obtained from stimulated PBMCs. Data represents mean +/- SEM. The EBVDNA1 peptides were unable to stimulate IFN- γ production in either CD8 T cells indicating a lack of an immune response, as shown in Table 4.

5

Table 4. IMMUNE RESPONSE to EBVDNA1 PRIME-BOOST

Stimulatory Peptide Epitope	Percentage of CD8 T Cells Secreting Interferon (IFN) γ			
	Control Group Lentivirus-GFP Prime MG1-GFP Boost		Immune Group Lentivirus- EBVDNA1 Prime MG1- EBVDNA1 Boost (N=5)	
VYGGSKTSL	0.055 \pm 0.015 (after prime)	0.01 \pm 0.0058 (after boost)	0.008 \pm 0.0049 (after prime)	0.09 \pm 0.05 (after boost)

[00159] Example 10: Effect of Cyclophosphamide on Adenovirus-OV Vaccine Prime-Boost Strategy:

10 **[00160]** Cyclophosphamide (CPA) is a chemotherapeutic agent used to treat various types of cancer. High doses of this drug are required for effective chemotherapy. High doses of CPA are thought to lead to immunosuppression while low doses of the drug can lead to enhanced immune responses against a variety of antigens. Surprisingly, in the heterologous prime-boost strategy of the current disclosure, CPA only results in an increase in immune response when administered prior to the priming of the immune system by the first virus.

15 **[00161]** In order to generate lung metastases, C57Bl/6 mice (8-10 weeks old at study initiation) were injected with 2.5×10^5 B16-F10 cells (murine melanoma cells expressing the murine DCT antigen) in 200 μ l saline water i.v. at day 0. Five days following B16-F10 engraftment, mice received an Ad-hDCT priming vaccine (2×10^8 pfu in 200 μ l PBS i.m.) and this was followed 14 days later by a single i.v. dose of VSV-hDCT (2×10^9 pfu in 200 μ l PBS
20 i.v.) as an oncolytic booster vaccine. Additionally, mice either received vehicle or CPA (1mg/20g mouse, i.p.) at day (-1) prior to the prime and/or day 13 prior to the boost. In Figure 9 it can be seen that CPA given prior to the priming vector significantly increases survival while CPA administered prior to the boosting vector does not extend survival (data not shown).

[00162] In the preceding description, for purposes of explanation, numerous details are set forth in order to provide a thorough understanding of the examples. The above-described examples are intended to be exemplary only. Alterations, modifications and variations can be effected to the particular examples by those of skill in the art without departing from the scope, which is defined solely by the claims appended hereto.

Appendix A – Protein and Nucleotide Sequences

Protein sequence of full length, wild type, human MAGEA3 (SEQ ID NO: 1):

MPLEQRSQHCKPEEGLEARGEALGLVGAQAPATEEQEAASSSSTLVEVTLGEVPAESP
 5 PPQSPQGASSLPTTMNYPLWSQSYEDSSNQEEEGPSTFPDLESEFQAALSRKVAELVHFL
 LKYRAREPVTKAEMLGSVVGNWQYFFPVIFSKASSLQLVFGIELMEVDPIGHLYIFATCLGL
 SYDGLLDGNQIMPKAGLLIIVLAIAREGDCAPEEKIWEELSVLEVFEGREDSILGDPKLLTQ
 HFVQENYLEYRQVPGSDPACYEFLWGPRALVETSYVKVLHMHMVKISGGPHISYPPLHEWVL
 REGEE*

10

DNA sequence encoding full length, wild type, human MAGEA3 (SEQ ID NO: 2):

ATGCCTCTTGAGCAGAGGAGTCAGCACTGCAAGCCTGAAGAAGGCCTTGAGGCCCGAG
 GAGAGGCCCTGGGCCTGGTGGGTGCGCAGGCTCCTGCTACTGAGGAGCAGGAGGCTG
 CCTCCTCCTCTTCTACTCTAGTTGAAGTCACCCTGGGGGAGGTGCCTGCTGCCGAGTCA
 15 CCAGATCCTCCCCAGAGTCCTCAGGGAGCCTCCAGCCTCCCCACTACCATGAACTACC
 CTCTCTGGAGCCAATCCTATGAGGACTCCAGCAACCAAGAAGAGGAGGGGCCAAGCAC
 CTTCCCTGACCTGGAGTCCGAGTTCCAAGCAGCACTCAGTAGGAAGGTGGCCGAGTTG
 GTTCATTTTCTGCTCCTCAAGTATCGAGCCAGGGAGCCGGTCACAAAGGCAGAAATGCT
 GGGGAGTGTCGTCGGAAATTGGCAGTATTTCTTTCCTGTGATCTTCAGCAAAGCTTCCA
 20 GTTCCTTGCAGCTGGTCTTTGGCATCGAGCTGATGGAAGTGGACCCCATCGGCCACTT
 GTACATCTTTGCCACCTGCCTGGGCCTCTCCTACGATGGCCTGCTGGGTGACAATCAGA
 TCATGCCCAAGGCAGGCCTCCTGATAATCGTCCTGGCCATAATCGCAAGAGAGGGCGA
 CTGTGCCCTGAGGAGAAAATCTGGGAGGAGCTGAGTGTGTTAGAGGTGTTTGAGGGG
 AGGGAAGACAGTATCTTGGGGGATCCCAAGAAGCTGCTCACCCAACATTTTCGTGCAGG
 25 AAAACTACCTGGAGTACCGGCAGGTCCCCGGCAGTGATCCTGCATGTTATGAATTCCTG
 TGGGGTCCAAGGGCCCTCGTTGAAACCAGCTATGTGAAAGTCCTGCACCATATGGTAAA
 GATCAGTGGAGGACCTCACATTTCTACCCACCCCTGCATGAGTGGGTTTTGAGAGAG
 GGGGAAGAGTGA

30 Codon optimized DNA sequence encoding full length, wild type, human MAGEA3 protein (SEQ ID NO: 3):

ATGCCCTGGAGCAGCGGTCTCAGCATTGCAAGCCAGAGGAGGGCCTCGAGGCGAGG
 GGCGAGGCCCTCGGCTTGGTGGGGGCGCAGGCTCCTGCAACCGAGGAGCAAGAGGC

CGCATCCAGTTCCTCTACCCTGGTTGAGGTGACCTTGGGTGAGGTGCCCGCCGCGGAG
AGCCCCGACCCGCCTCAAAGCCCCCAGGGTGCCAGCTCCCTGCCACACAACATGAACT
ACCCACTCTGGAGTCAGTCTTACGAGGACAGTAGTAACCAAGAGGAGGAGGGACCCTC
CACATTCCCAGACCTGGAGTCTGAATTCCAGGCAGCATTGTCTAGAAAAGTGGCCGAAT
5 TGGTGCACTTCCTGCTGCTGAAGTATCGCGCCCCGCGAGCCAGTCACAAAAGCTGAAAT
GCTGGGTTCTGTCTGCTGGGAAATTGGCAGTACTTCTTCCCCGTGATCTTCAGTAAAGCGT
CCAGCTCCTTGCAGCTGGTCTTTGGTATCGAGCTGATGGAGGTGGATCCCATCGGCCA
TCTGTATATCTTTGCCACATGCCTGGGCCTGAGCTACGATGGCCTGCTGGGCGACAAC
CAGATCATGCCAAAAGCTGGCCTGCTGATCATCGTTCTGGCTATCATCGCTAGAGAAGG
10 AGATTGCGCCCCTGAAGAAAAGATCTGGGAGGAACTGAGCGTCCTGGAAGTCTTTGAG
GGTCGTGAAGACAGCATTCTCGGGGATCCCAAGAAGCTGCTGACCCAGCACTTCGTGC
AGGAGAACTATCTGGAGTACCGCCAGGTTCCCGGCAGCGACCCCGCTTGCTACGAGTT
CCTGTGGGGCCCCAGGGCCCTGGTCGAGACATCCTACGTGAAGGTCCTGCACCATATG
GTTAAAATCAGCGGCGGCCCCCATATCTCTTATCCGCCGCTCCACGAGTGGGTGCTCC
15 GGGAGGGAGAGGAG

Protein sequence of a variant of full length, wild type, human MAGEA3 (SEQ ID NO: 4):

MPLEQRSQHCKPEEGLEARGEALGLVGAQAPATEEQEAASSSSTLVEVTLGEVPAESP
PPQSPQGASSLPTTMNYPLWSQSYEDSSNQEEEGPSTFPDLESEFQAALSRKVAELVHFL
20 LKYRAREPVTKAEMLGSVVGNWQYFFPVIFSKASSSLQLVFGIELMEVDPIGHLYIFATCLGL
SYDGLLGDNQIMPKAGLLIIVLAIAREGDCAPEEKIWEELSVLEVFEGREDSILGDPKLLTQ
HFVQENYLEYRQVPGSDPACYEFLWGPRALVETSYVKVLHMHMVKISGGPHISYPPLHEWVL
REGEDDYKDDDDK*

25 DNA sequence encoding a variant of full length, wild type, human MAGEA3 (SEQ ID NO: 5):

ATGCCCTGGAACAGCGGAGCCAGCACTGCAAGCCCGAGGAAGGCCTGGAAGCCAGA
GGCGAAGCCCTGGGACTGGTGGGAGCCCAGGCCCTGCCACAGAAGAACAGGAAGCC
GCCAGCAGCAGCTCCACCCTGGTGGAAAGTGACCCTGGGCGAAGTGCCTGCCGCCGAG
30 AGCCCTGATCCCCCTCAGTCTCCTCAGGGCGCCAGCAGCCTGCCACCACCATGAACT
ACCCCTGTGGTCCCAGAGCTACGAGGACAGCAGCAACCAGGAAGAGGAAGGCCCCA
GCACCTTCCCCGACCTGGAAAGCGAGTTCCAGGCCGCCCTGAGCCGGAAGGTGGCAG
AGCTGGTGCCTTCCTGCTGCTGAAGTACAGAGCCCGCGAGCCCGTGACCAAGGCCGA

GATGCTGGGCAGCGTGGTGGGAAACTGGCAGTACTTCTTCCCCGTGATCTTCTCCAAG
 GCCAGCAGCTCCCTGCAGCTGGTGTTCGGCATCGAGCTGATGGAAGTGGACCCCATCG
 GCCACCTGTACATCTTCGCCACCTGTCTGGGCCTGAGCTACGACGGCCTGCTGGGCGA
 CAACCAGATCATGCCCAAGGCCGGCCTGCTGATCATCGTGCTGGCCATCATTGCCCGC
 5 GAGGGCGACTGCGCCCCTGAGGAAAAGATCTGGGAGGAACTGAGCGTGCTGGAAGTG
 TTCGAGGGCAGAGAGGACAGCATCCTGGGCGACCCCAAGAAGCTGCTGACCCAGCAC
 TTCGTGCAGGAAAACCTGGAATACCGCCAGGTGCCCGGCAGCGACCCCGCCTGTT
 ACGAGTTCCTGTGGGGCCCCAGGGCTCTGGTGGAAACCAGCTACGTGAAGGTGCTGCA
 CCACATGGTGAAAATCAGCGGCGGACCCACATCAGCTACCCCCCACTGCACGAGTGG
 10 GTGCTGAGAGAGGGCGAAGAGGACTACAAGGACGACGACGACAAATGA

Protein sequence of HPV E6/E7 fusion protein (SEQ ID NO: 7):

MHQKRTAMFQDPQERPRKLPQLCTELQTTIHDIILECVYCKQQLLRREYDFAFRDLCIVYR
 DGNPYAVDKLKFYSKISEYRHYCYSVYGTTLEQQYNKPLCDLLIRINQKPLCPEEKQRHLDK
 15 KQRFHNIRGRWTGRCMSCCRSSRTRRETQLGGGGGAAYMARFEDPTRRPYKLPDLCTEL
 NTSLQDIEITCVYCKTVLELFEVFAFKDLFVVYRDSIPHAAHKIDFYSRIRELRHYSDSVYG
 DTLEKLTNTGLYNLLIRLRQKPLNPAEKLRHLNEKRRFHNIAGHYRGQCHSCCNRARQERL
 QRRRETQVGGGGGAAYMHGDTPTLHEYMLDLQPETTDLYQLNDSSEEEDEIDGPAGQAEP
 DRAHYNIVTFCKCDSTLRLCVQSTHVDIRTLEDLLMGTLGIVPICSQKPGGGGGGAAYMHGP
 20 KATLQDIVLHLEPQNEIPVDLLQLSDSEEENDEIDGVNHQHLPARRAEPQRHTMLCMCKCE
 ARIKLVVRESSADDLRAFQQLFLNLSFVPWCASQQ*

DNA sequence of HPV E6/E7 fusion protein (SEQ ID NO: 8):

ATGCATCAGAAGCGAACTGCTATGTTTCAGGACCCTCAGGAGCGGCCACGCAAACACTGC
 25 CTCAGCTGTGCACCGAACTGCAGACAACACTATCCACGACATCATTCTGGAATGCGTGAC
 TGTAAGCAGCAGCTGCTGAGGAGAGAGGTCTATGACTTCGCTTTTCGCGATCTGTGCAT
 CGTGTACCGAGACGGAAACCCATATGCAGTCGATAAGCTGAAGTTCTACAGCAAGATCT
 CCGAATACAGGCATTACTGTTACAGCGTGTACGGGACCACACTGGAGCAGCAGTATAAC
 AAGCCCCTGTGCGACCTGCTGATCAGAATTAATCAGAAGCCCCTGTGCCCTGAGGAAAA
 30 ACAGAGGCACCTGGATAAGAAACAGAGATTTTCATAACATCCGAGGACGATGGACCGGG
 CGGTGCATGTCCTGCTGTAGAAGCTCCCGGACTCGACGAGAGACCCAGCTGGGCGGA
 GGAGGAGGAGCAGCTTACATGGCACGATTCGAGGACCCTACCCGAAGGCCATATAAGC
 TGCCCGACCTGTGCACAGAACTGAATACTTCTCTGCAGGACATCGAGATTACATGCGTG

TACTGTAAAACCGTCCTGGAGCTGACAGAAGTGTTTCGAGTTTGCTTTCAAGGACCTGTT
 TGTGGTCTACCGGGATTCAATCCCTCACGCAGCCCATAAAATCGACTTCTACAGCAGGA
 TCAGGGAACTGCGCCACTACTCCGACAGCGTGTACGGGGATACACTGGAGAAGCTGAC
 AAACACTGGCCTGTACAATCTGCTGATCCGACTGCGACAGAAGCCACTGAACCCAGCC
 5 GAAAACTGAGACACCTGAACGAGAAGAGACGGTTTCACAATATTGCAGGCCATTATAG
 GGGACAGTGCCATAGTTGCTGTAATCGAGCCAGGCAGGAAAGACTGCAGCGCCGAAG
 GGAGACTCAAGTCGGCGGAGGAGGAGGAGCTGCATACATGCACGGCGACACCCCCAC
 ACTGCATGAATATATGCTGGATCTGCAGCCTGAGACTACCGACCTGTACCAGCTGAACG
 ATTCTAGTGAGGAAGAGGACGAAATCGACGGACCAGCAGGACAGGCAGAGCCTGACC
 10 GGGCCCACTATAATATTGTGACATTCTGCTGTAAGTGCGATTCTACTCTGCGGCTGTGC
 GTGCAGAGTACTCATGTGACATCCGCACCCTGGAGGATCTGCTGATGGGGACTCTGG
 GCATCGTCCCAATTTGTAGCCAGAAACCAGGCGGCGGCGGCGGAGCAGCTTACATGCA
 CGGACCCAAGGCTACCCTGCAGGACATCGTGCTGCATCTGGAACCTCAGAATGAGATT
 CCAGTCGACCTGCTGCAGCTGAGTGATTCAGAAGAGGAAAACGACGAGATCGACGGCG
 15 TGAATCACCAGCATCTGCCTGCTAGACGGGCAGAGCCACAGCGACACACAATGCTGTG
 CATGTGCTGTAAGTGTGAAGCCAGGATCAAGCTGGTGGTCGAGTCAAGCGCCGACGAT
 CTGCGCGCCTTCCAGCAGCTGTTCCCTGAATACTCTGTCATTTGTCCCTTGGTGTGCCTC
 CCAGCAGTGA

20 **Protein sequence of huSTEAP protein (SEQ ID NO: 10):**

MESRKDITNQEELWKMKPRRNLEEDDYLHKDTGETSMLKRPVLLHLHQTAHADEFDCPSEL
 QHTQELFPQWHLPIKIAAIIASLTFLYTLREVIHPLATSHQQYFYKIPILVINKVLPMSITLLAL
 VYLPGVIAAIVQLHNGTKYKKFPHWLDKWMLTRKQFGLLSFFFAVLHAIYSLSYPMRRSYRY
 KLLNWAYQQVQQNKEDAWIEHDVWRMEIYVSLGIVGLAILALLAVTSIPSVSDSLTWREFHYI
 25 QSKLGIVSLLLGTIHALIFAWNKWIDIKQFVWYTPPTFMIAVFLPIVVLIFKSILFLPCLRKKILKIR
 HGWEDVTKINKTEICSQLKL*

DNA sequence of huSTEAP protein (SEQ ID NO: 11):

ATGGAATCACGGAAGGACATCACTAATCAGGAGGAACTGTGGAAAATGAAGCCAAGAA
 30 GGAATCTGGAAGAGGACGACTATCTGCACAAGGACACCGGCGAAACAAGTATGCTGAA
 ACGACCAGTGCTGCTGCACCTGCATCAGACTGCTCACGCAGACGAGTTTGATTGCCCC
 TCTGAACTGCAGCACACCCAGGAGCTGTTCCACAGTGGCATCTGCCCATCAAGATTGC
 CGCTATCATTGCTTCACTGACATTTCTGTACACTCTGCTGAGAGAAGTGATCCACCCCCT

GGCCACCAGCCATCAGCAGTACTTCTATAAGATCCCTATCCTGGTCATCAACAAGGTCC
TGCCAATGGTGAGCATCACACTGCTGGCCCTGGTCTACCTGCCTGGAGTGATCGCAGC
CATTGTCCAGCTGCACAATGGGACAAAGTATAAGAAATTTCCACATTGGCTGGATAAGT
GGATGCTGACTAGGAAACAGTTCGGACTGCTGTCCTTCTTTTTTCGCCGTGCTGCACGCT
5 ATCTACAGCCTGTCCTATCCCATGAGGAGGAGCTACCGGTATAAGCTGCTGAACTGGG
CTTACCAGCAGGTGCAGCAGAACAAGGAGGACGCATGGATTGAACATGACGTGTGGCG
CATGGAAATCTACGTGAGCCTGGGCATTGTCGGACTGGCCATCCTGGCTCTGCTGGCA
GTGACCAGTATCCCTTCTGTCAGTGACTIONACTGACATGGAGAGAGTTTTCACTACATTCA
GAGCAAGCTGGGGATCGTGTCCCTGCTGCTGGGCACCATCCATGCACTGATTTTTTGCC
10 TGGAACAAGTGGATCGATATCAAGCAGTTCGTGTGGTATACTCCCCCTACCTTTATGATT
GCCGTCTTCCTGCCCATCGTGGTCCTGATCTTCAAGTCCATCCTGTTCTGCCTTGTCT
GCGGAAGAAAATCCTGAAAATTCGGCACGGATGGGAGGATGTCACCAAATCAATAAGA
CTGAAATCTGTAGCCAGCTGAAGCTTTAA

15 **Protein sequence of NYESO1 MAR protein (SEQ ID NO: 13):**

MQAEGRGTGGSTGDADGPGGPGIPDGPGGNAGGPGEAGATGGRGPRGAGAARASGPG
GGAPRGPHGGAASGLNGCCRCGARGPESRLLEFYLAMPFATPMEAEELARRSLAQDAPPLP
VPGVLLKEFTVSGNILTIRLTAADHRQLQLSISCLQQLSLLMWITQCFLPVFLAQPPSGQRR*

20 **DNA sequence of NYESO1 MAR (SEQ ID NO: 14):**

ATGCAGGCCGAGGGCAGAGGCACAGGCGGATCTACAGGCGACGCCGATGGCCCTGGC
GGCCCTGGAATTCCTGACGGACCTGGCGGCAATGCCGGCGGACCCGGAGAAGCTGGC
GCCACAGGCGGAAGAGGACCTAGAGGCGCTGGCGCCGCTAGAGCTTCTGGACCAGGC
GGAGGCGCCCCTAGAGGACCTCATGGCGGAGCCGCCTCCGGCCTGAACGGCTGTTGC
25 AGATGTGGAGCCAGAGGCCCCGAGAGCCGGCTGCTGGAATTCTACCTGGCCATGCCCT
TCGCCACCCCATGGAAGCCGAGCTGGCCAGACGGTCCCTGGCCCAGGATGCTCCTC
CTCTGCCTGTGCCCGGCGTGCTGCTGAAAGAATTCACCGTGTCCGGCAACATCCTGAC
CATCCGGCTGACTGCCGCCGACCACAGACAGCTCCAGCTGTCTATCAGCTCCTGCCTG
CAGCAGCTGAGCCTGCTGATGTGGATCACCCAGTGCTTTCTGCCCGTGTTCTGGCTC
30 AGCCCCCAGCGGCCAGAGAAGATGA

Protein sequence of EBDNA1 (SEQ ID NO: 16):

MPVGQADYFEYHQEGGPDGEPDMPPGAIEQGPADDPGEGPSTGPRGQGDGGRRKKGG
WFGKHRGQGGSNQKFENIADGLRTLARCHVERTTDEGTWVAGVFVYGGSKTSLYNLRR
GISLAIPQCRLTPLSRLPFGMAPGPGPQPGLRESIVCYFIVFLQTHIFAEGLKDAIKDLVMPK
5 PAPTCHIKATVCSFDDGVDLPPWFPPMVEGAAAEGDDGDDGDDGDEGGDGDEGEEGQE*

DNA sequence of EBDNA1 (SEQ ID NO: 17):

ATGCCAGTCGGCCAGGCTGATTACTTTGAATACCACCAGGAGGGGGGACCAGACGGAG
AACCAGACATGCCACCAGGAGCCATTGAACAGGGACCAGCAGACGATCCTGGAGAGG
10 GACCATCAACTGGACCCCGAGGACAGGGGGACGGCGGAAGGAGAAAGAAAGGGGGAT
GGTTCGGAAAGCACCGAGGACAGGGAGGGAGCAACCAGAAATTTGAAAATATCGCTGA
CGGCCTGCGAACACTGCTGGCAAGGTGCCATGTGGAGAGAACCACAGATGAAGGCACA
TGGGTCGCCGGAGTGTTCTGTCTACGGCGGAAGCAAGACTTCCCTGTATAACCTGCGGC
GCGGCATCTCTCTGGCCATTCCACAGTGCCGGCTGACCCCTCTGAGTCGCCTGCCATT
15 CGGGATGGCTCCTGGACCAGGACCACAGCCTGGACCACTGAGGGAGTCCATCGTGTG
CTACTTCATTGTCTTTCTGCAGACACACATCTTTGCCGAAGGCCTGAAGGACGCCATCA
AGGACCTGGTCATGCCCAAGCCTGCACCAACTTGCAATATCAAGGCCACCGTGTGCAG
TTTCGACGATGGCGTGGACCTGCCCCCTTGGTTTCCACCTATGGTGGAGGGAGCCGCT
GCAGAAGGGGACGATGGCGATGACGGGGACGATGGGGATGAAGGCGGGGACGGCGA
20 TGAGGGAGAAGAGGGGGCAGGAATAA

WHAT IS CLAIMED IS:

1. A kit for use in inducing an immune response in a mammal, the kit comprising:
a first virus that expresses a protein comprising an amino acid sequence of SEQ ID
5 NO: 1, or a variant thereof, as an antigenic protein and that is formulated to generate an
immunity to the protein or variant thereof in the mammal; and
a Maraba MG1 virus encoding a protein comprising an amino acid sequence SEQ ID
NO: 1, or a variant thereof, as an antigenic protein, the Maraba MG1 virus formulated to
induce the immune response in the mammal;
10 the first virus being immunologically distinct from the Maraba MG1 virus.
2. The kit according to claim 1, wherein the antigenic protein expressed by the first virus
and the antigenic protein expressed by the Maraba MG1 virus are identical.
- 15 3. The kit according to claim 1 or 2, wherein the first virus, the Maraba MG1 virus, or
both, are formulated for administration as isolated viruses.
4. The kit according to any one of claims 1-3, wherein
the Maraba MG1 virus includes a reverse complement and RNA version of a
20 transgene comprising a nucleotide sequence of SEQ ID NO: 2;
the first virus is a negative strand RNA virus and includes a reverse complement and
RNA version of a transgene comprising a nucleotide sequence of SEQ ID NO: 2;
the first virus is a DNA virus or a positive sense RNA virus and includes a transgene
comprising a nucleotide sequence of SEQ ID NO: 2; or
25 the Maraba MG1 virus includes a reverse complement and RNA version of a
transgene comprising a nucleotide sequence of SEQ ID NO: 2, and
 - a) the first virus is a negative strand RNA virus and includes a reverse
complement and RNA version of a transgene comprising a nucleotide sequence of
SEQ ID NO: 2, or
 - 30 b) the first virus is a DNA virus or a positive sense RNA virus and includes a
transgene comprising a nucleotide sequence of SEQ ID NO: 2.

5. The kit according to any one of claims 1-3, wherein the Maraba MG1 virus includes a reverse complement and RNA version of a transgene comprising a nucleotide sequence of SEQ ID NO: 3;

the first virus is a negative strand RNA virus and includes a reverse complement and RNA version of a transgene comprising a nucleotide sequence of SEQ ID NO: 3; or

the first virus is a DNA virus or a positive sense RNA virus and includes a transgene comprising a nucleotide sequence of SEQ ID NO: 3; or

the Maraba MG1 virus includes a reverse complement and RNA version of a transgene comprising a nucleotide sequence of SEQ ID NO: 3, and

10 a) the first virus is a negative strand RNA virus and includes a reverse complement and RNA version of a transgene comprising a nucleotide sequence of SEQ ID NO: 3, or

b) the first virus is a DNA virus or a positive sense RNA virus and includes a transgene comprising a nucleotide sequence of SEQ ID NO: 3.

15

6. The kit according to any one of claims 1-3, wherein the protein variant that is expressed by the first virus, the Maraba MG1 virus, or both, includes at least one tumor associated epitope selected from the group consisting of: FLWGPRALV, KVAELVHFL, EGDCAPEEK, KKLLTQHFVQENYLEY, RKVAELVHFLLLKYR, and KKLLTQHFVQENYLEY, and is at least 70% identical to SEQ ID NO: 1.

20

7. The kit according to claim 6, wherein the variant is at least 80% identical to SEQ ID NO: 1.

25 8. The kit according to claim 6, wherein the variant is at least 90% identical to SEQ ID NO: 1.

9. The kit according to claim 6, wherein the variant is at least 95% identical to SEQ ID NO: 1.

30

10. The kit according to claim 6, wherein the protein variant that is expressed by the first virus, the Maraba MG1 virus, or both, has an amino acid sequence of SEQ ID NO: 4.

11. The kit according to claim 6, wherein the protein variant is encoded by a nucleotide sequence of SEQ ID NO: 5.

12. The kit according to any one of claims 1-3 and 6-11, wherein the Maraba MG1 virus and the first virus express different variants of the protein that comprises the sequence of SEQ ID NO: 1.

13. The kit according to claim 12, wherein
the Maraba MG1 virus includes a reverse complement and RNA version of a nucleotide sequence of SEQ ID NO: 2 or 3, and the first virus is a negative sense RNA virus and includes a reverse complement and RNA version of SEQ ID NO: 5;

the Maraba MG1 virus includes a reverse complement and RNA version of a nucleotide sequence of SEQ ID NO: 5, and the first virus is a negative sense RNA virus and includes a reverse complement and RNA version of SEQ ID NO: 2 or 3;

15 the Maraba MG1 virus includes a reverse complement and RNA version of a nucleotide sequence of SEQ ID NO: 2 or 3, and the first virus is a DNA or RNA virus and includes a sequence which is SEQ ID NO: 5; or

the Maraba MG1 virus includes a reverse complement and RNA version of a nucleotide sequence of SEQ ID NO: 5, and the first virus is a DNA or RNA virus and includes a sequence which is SEQ ID NO: 2 or 3.

14. The kit according to claim 12, wherein one of either the Maraba MG1 virus or the first virus are capable of expressing a protein that comprises the sequence of SEQ ID NO: 1 or 4, and the other of the Maraba MG1 virus and the first virus are capable of expressing a protein that comprises the other sequence.

15. The kit according to any one of claims 1-14, wherein the first virus is an adenovirus.

16. An isolated Maraba MG1 viral particle having a genome that encodes a protein comprising an amino acid sequence of SEQ ID NO: 1, or a variant thereof.

17. The isolated Maraba MG1 viral particle according to claim 16, wherein the variant the protein comprising an amino acid sequence of SEQ ID NO: 1 has at least one tumor

associated epitope selected from the group consisting of: FLWGPRALV, KVAELVHFL, EGDCAPEEK, KKLLTQHFVQENYLEY, RKVAELVHFLLLKYR, and KKLLTQHFVQENYLEY, and is at least 70% identical to SEQ ID NO: 1.

5 18. The isolated Maraba MG1 viral particle according to claim 17, wherein the variant is at least 80% identical to SEQ ID NO: 1.

19. The isolated Maraba MG1 viral particle according to claim 17, wherein the variant is at least 90% identical to SEQ ID NO: 1.

10

20. The isolated Maraba MG1 viral particle according to claim 17, wherein the variant is at least 95% identical to SEQ ID NO: 1.

15 21. The isolated Maraba MG1 viral particle according to claim 16, wherein the variant of the protein comprising an amino acid sequence of SEQ ID NO: 1 has an amino acid sequence of SEQ ID NO: 4.

20 22. The isolated Maraba MG1 viral particle according to claim 16, where the genome includes a reverse complement and RNA version of a nucleotide sequence of SEQ ID NO: 2, 3 or 5.

23. The isolated Maraba MG1 viral particle according to claim 16, where the genome includes a reverse complement and RNA version of a nucleotide sequence of SEQ ID NO: 6.

25 24. A kit for use in inducing an immune response in a mammal, the kit comprising:
a first virus that expresses a protein comprising an amino acid sequence of SEQ ID NO: 7, or a variant thereof, as an antigenic protein and that is formulated to generate an immunity to the protein or variant thereof in the mammal; and
a Maraba MG1 virus encoding a protein comprising an amino acid sequence of SEQ
30 ID NO: 7, or a variant thereof, as an antigenic protein, the Maraba MG1 virus formulated to induce the immune response in the mammal;
the first virus being immunologically distinct from the Maraba MG1 virus.

25. The kit according to claim 24, wherein the antigenic protein expressed by the first virus and the antigenic protein expressed by the Maraba MG1 virus are identical.

26. The kit according to claim 24 or 25, wherein the first virus, the Maraba MG1 virus, or both, are formulated for administration as isolated viruses.

27. The kit according to any one of claims 24-26, wherein the Maraba MG1 virus includes a codon optimized transgene comprising a reverse complement and RNA version of a nucleotide sequence of SEQ ID NO: 8;

10 the first virus is a negative sense RNA virus and includes a codon optimized transgene comprising a reverse complement and RNA version of a nucleotide sequence of SEQ ID NO: 8;

the first virus is a DNA virus or a positive sense RNA virus and includes a codon optimized transgene comprising a nucleotide sequence of SEQ ID NO: 8; or

15 the Maraba MG1 virus includes a codon optimized transgene comprising a reverse complement and RNA version of a nucleotide sequence of SEQ ID NO: 8, and

a) the first virus is a negative sense RNA virus and includes a codon optimized transgene comprising a reverse complement and RNA version of a nucleotide sequence of SEQ ID NO: 8, or

20 b) the first virus is a DNA virus or a positive sense RNA virus and includes a codon optimized transgene comprising a nucleotide sequence of SEQ ID NO: 8.

28. The kit according to any of of claims 24-26, wherein the protein variant that is expressed by the first virus, the Maraba MG1 virus, or both, includes at least one tumor associated epitope of SEQ ID NO: 7 and is at least 70% identical to SEQ ID NO: 7.

29. The kit according to claim 28, wherein the variant is at least 80% identical to SEQ ID NO: 7.

30 30. The kit according to claim 28, wherein the variant is at least 90% identical to SEQ ID NO: 7.

31. The kit according to claim 28, wherein the variant is at least 95% identical to SEQ ID NO: 7.

5 32. The kit according to any one of claims 24-26 and 28-31, wherein one of either the Maraba MG1 virus or the first virus is capable of expressing a protein that comprises the sequence of SEQ ID NO: 7, and the other of the Maraba MG1 virus and the first virus is capable of expressing a variant of a protein that comprises the sequence of SEQ ID NO: 7.

10 33. The kit according to any one of claims 24-26 and 28-31, wherein the Maraba MG1 virus and the first virus are capable of expressing different variants of the protein that comprises the sequence of SEQ ID NO: 7.

34. The kit according to any one of claims 24-33 where the first virus is a lentivirus.

15 35. An isolated Maraba MG1 viral particle having a genome that encodes encodes a protein comprising an amino acid sequence of SEQ ID NO: 7, or a variant thereof.

20 36. The isolated Maraba MG1 viral particle according to claim 35, wherein the genome includes a reverse complement and RNA version of a nucleotide sequence of SEQ ID NO: 8.

37. The isolated Maraba MG1 viral particle according to claim 35, wherein the genome includes a reverse complement and RNA version of a nucleotide sequence of SEQ ID NO: 9.

25 38. A kit for use in inducing an immune response in a mammal, the kit comprising:
a first virus that expresses a protein comprising an amino acid sequence of SEQ ID NO: 10, or a variant thereof, as an antigenic protein and that is formulated to generate an immunity to the protein or variant thereof in the mammal; and

30 a Maraba MG1 virus encoding a protein comprising an amino acid sequence of SEQ ID NO: 10, or a variant thereof, as an antigenic protein, the Maraba MG1 virus formulated to induce the immune response in the mammal;

the first virus being immunologically distinct from the Maraba MG1 virus.

39. The kit according to claim 38, wherein the antigenic protein expressed by the first virus and the antigenic protein expressed by the Maraba MG1 virus are identical.

40. The kit according to claim 38 or 39, wherein the first virus, the Maraba MG1 virus, or both, are formulated for administration as isolated viruses.

41. The kit according to any one of claims 38-40, wherein the Maraba MG1 virus includes a codon optimized transgene comprising a reverse complement and RNA version of a nucleotide sequence of SEQ ID NO: 11;

10 the first virus is a negative sense RNA virus and includes a codon optimized transgene comprising a reverse complement and RNA version of a nucleotide sequence of SEQ ID NO: 11;

the first virus is a DNA virus or a positive sense RNA virus and includes a codon optimized transgene comprising a nucleotide sequence of SEQ ID NO: 11; or

15 the Maraba MG1 virus includes a codon optimized transgene comprising a reverse complement and RNA version of a nucleotide sequence of SEQ ID NO: 11, and

a) the first virus is a negative sense RNA virus and includes a codon optimized transgene comprising a reverse complement and RNA version of a nucleotide sequence of SEQ ID NO: 11, or

20 b) the first virus is a DNA virus or a positive sense RNA virus and includes a codon optimized transgene comprising a nucleotide sequence of SEQ ID NO: 11.

42. The kit according to any of of claims 38-40, wherein the protein variant that is expressed by the first virus, the Maraba MG1 virus, or both, includes at least one tumor associated epitope of SEQ ID NO: 10 and is at least 70% identical to SEQ ID NO: 10.

43. The kit according to claim 42, wherein the variant is at least 80% identical to SEQ ID NO: 10.

30 44. The kit according to claim 42, wherein the variant is at least 90% identical to SEQ ID NO: 10.

45. The kit according to claim 42, wherein the variant is at least 95% identical to SEQ ID NO: 10.

5 46. The kit according to any one of claims 38-40 and 42-45, wherein one of either the Maraba MG1 virus or the first virus is capable of expressing a protein that comprises the sequence of SEQ ID NO: 10, and the other of the Maraba MG1 virus and the first virus is capable of expressing a variant of a protein that comprises the sequence of SEQ ID NO: 10.

10 47. The kit according to any one of claims 38-40 and 42-45, wherein the Maraba MG1 virus and the first virus are capable of expressing different variants of the protein that comprises the sequence of SEQ ID NO: 10.

48. The kit according to any one of claims 38-47 where the first virus is a lentivirus.

15 49. An isolated Maraba MG1 viral particle having a genome that encodes encodes a protein comprising an amino acid sequence of SEQ ID NO: 10, or a variant thereof.

20 50. The isolated Maraba MG1 viral particle according to claim 49, wherein the genome includes a reverse complement and RNA version of a nucleotide sequence of SEQ ID NO: 11.

25 51. The isolated Maraba MG1 viral particle according to claim 49, wherein the genome includes a reverse complement and RNA version of a nucleotide sequence of SEQ ID NO: 12.

30 52. A kit for use in inducing an immune response in a mammal, the kit comprising:
a first virus that expresses a protein comprising an amino acid sequence of SEQ ID NO: 13, or a variant thereof, as an antigenic protein and that is formulated to generate an immunity to the protein or variant thereof in the mammal; and
a Maraba MG1 virus encoding a protein comprising an amino acid sequence of SEQ ID NO: 13, or a variant thereof, as an antigenic protein, the Maraba MG1 virus formulated to induce the immune response in the mammal;
the first virus being immunologically distinct from the Maraba MG1 virus.

53. The kit according to claim 52, wherein the antigenic protein expressed by the first virus and the antigenic protein expressed by the Maraba MG1 virus are identical.

5 54. The kit according to claim 52 or 53, wherein the first virus, the Maraba MG1 virus, or both, are formulated for administration as isolated viruses.

55. The kit according to any one of claims 52-54, wherein
the Maraba MG1 virus includes a codon optimized transgene comprising a reverse
10 complement and RNA version of a nucleotide sequence of SEQ ID NO: 14;

the first virus is a negative sense RNA virus and includes a codon optimized
transgene comprising a reverse complement and RNA version of a nucleotide sequence of
SEQ ID NO: 14;

15 the first virus is a DNA virus or a positive sense RNA virus and includes a codon
optimized transgene comprising a nucleotide sequence of SEQ ID NO: 14; or

the Maraba MG1 virus includes a codon optimized transgene comprising a reverse
complement and RNA version of a nucleotide sequence of SEQ ID NO: 14, and

20 a) the first virus is a negative sense RNA virus and includes a codon
optimized transgene comprising a reverse complement and RNA version of a
nucleotide sequence of SEQ ID NO: 14, or

b) the first virus is a DNA virus or a positive sense RNA virus and includes a
codon optimized transgene comprising a nucleotide sequence of SEQ ID NO: 14.

25 56. The kit according to any of of claims 52-54, wherein the protein variant that is
expressed by the first virus, the Maraba MG1 virus, or both, includes at least one tumor
associated epitope of SEQ ID NO: 13 and is at least 70% identical to SEQ ID NO: 13.

57. The kit according to claim 56, wherein the variant is at least 80% identical to SEQ ID
NO: 13.

30

58. The kit according to claim 56, wherein the variant is at least 90% identical to SEQ ID
NO: 13.

59. The kit according to claim 56, wherein the variant is at least 95% identical to SEQ ID NO: 13.

5 60. The kit according to any one of claims 52-54 and 56-59, wherein one of either the Maraba MG1 virus or the first virus is capable of expressing a protein that comprises the sequence of SEQ ID NO: 13, and the other of the Maraba MG1 virus and the first virus is capable of expressing a variant of a protein that comprises the sequence of SEQ ID NO: 13.

10 61. The kit according to any one of claims 52-54 and 56-59, wherein the Maraba MG1 virus and the first virus are capable of expressing different variants of the protein that comprises the sequence of SEQ ID NO: 13.

62. The kit according to any one of claims 52-61 where the first virus is a lentivirus.

15 63. An isolated Maraba MG1 viral particle having a genome that encodes encodes a protein comprising an amino acid sequence of SEQ ID NO: 13, or a variant thereof.

20 64. The isolated Maraba MG1 viral particle according to claim 63, wherein the genome includes a reverse complement and RNA version of a nucleotide sequence of SEQ ID NO: 14.

65. The isolated Maraba MG1 viral particle according to claim 63, wherein the genome includes a reverse complement and RNA version of a nucleotide sequence of SEQ ID NO: 15.

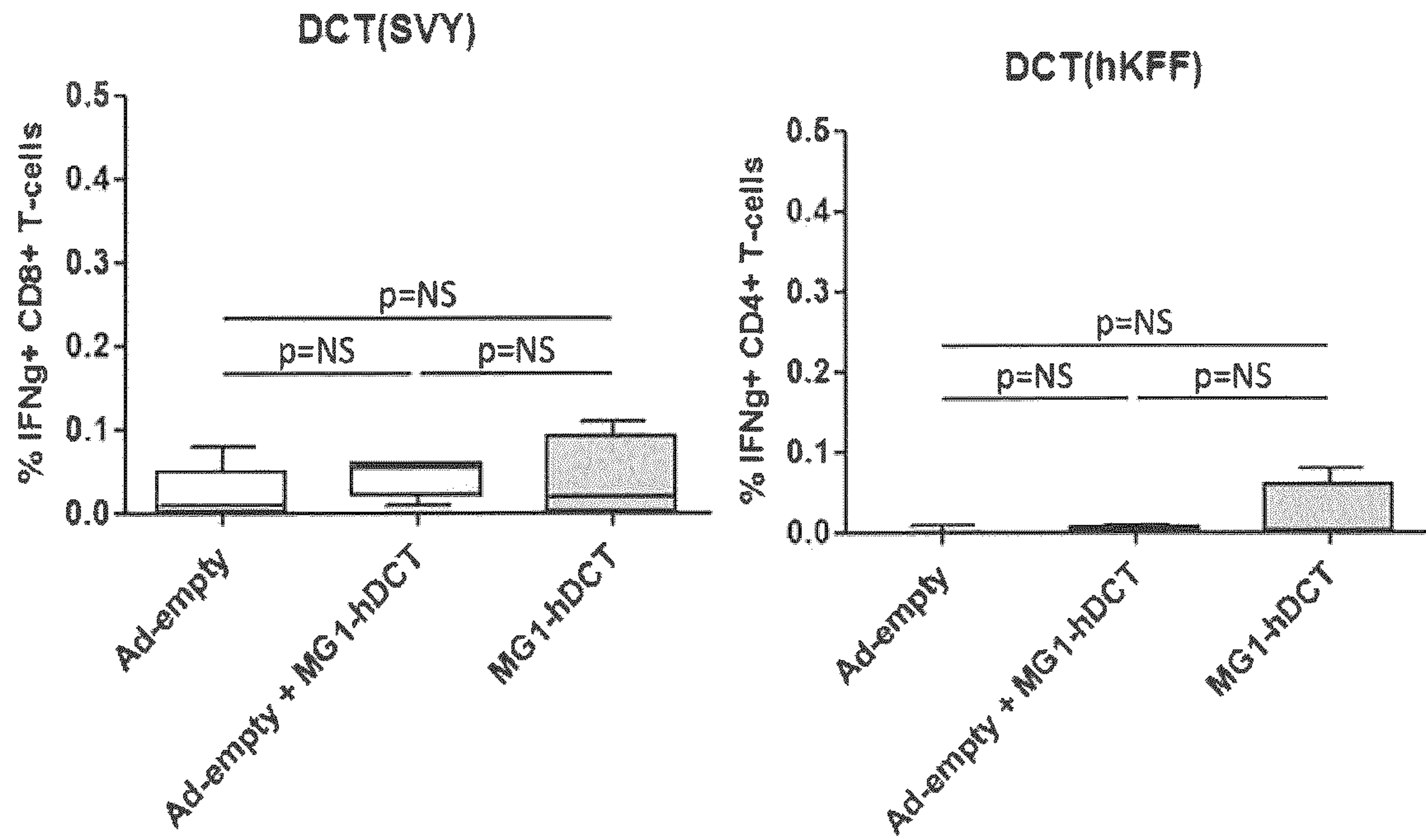

Figure 1A

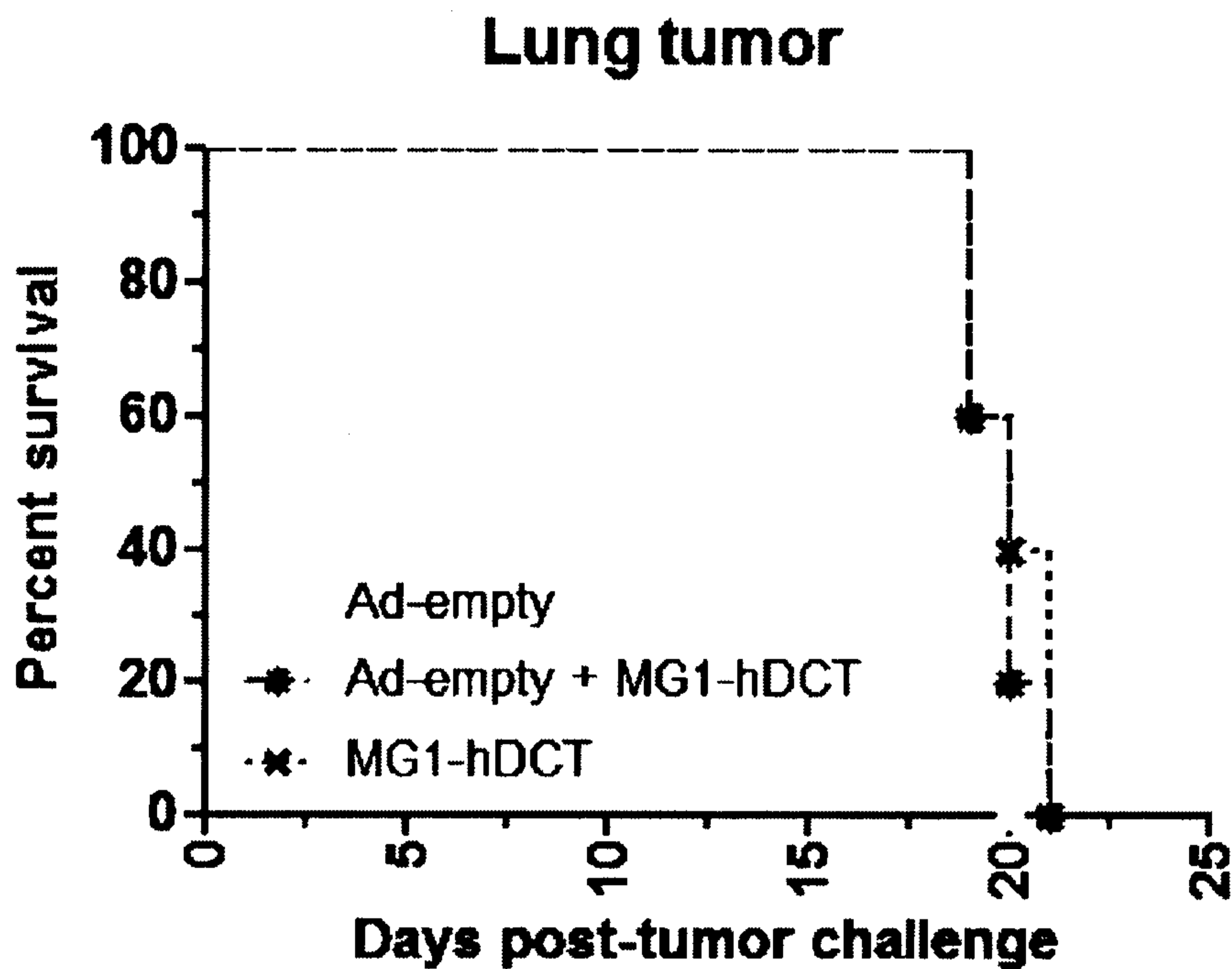

Figure 1B

Boost - Freq - DCT(SVY) CD8 T-cell resp

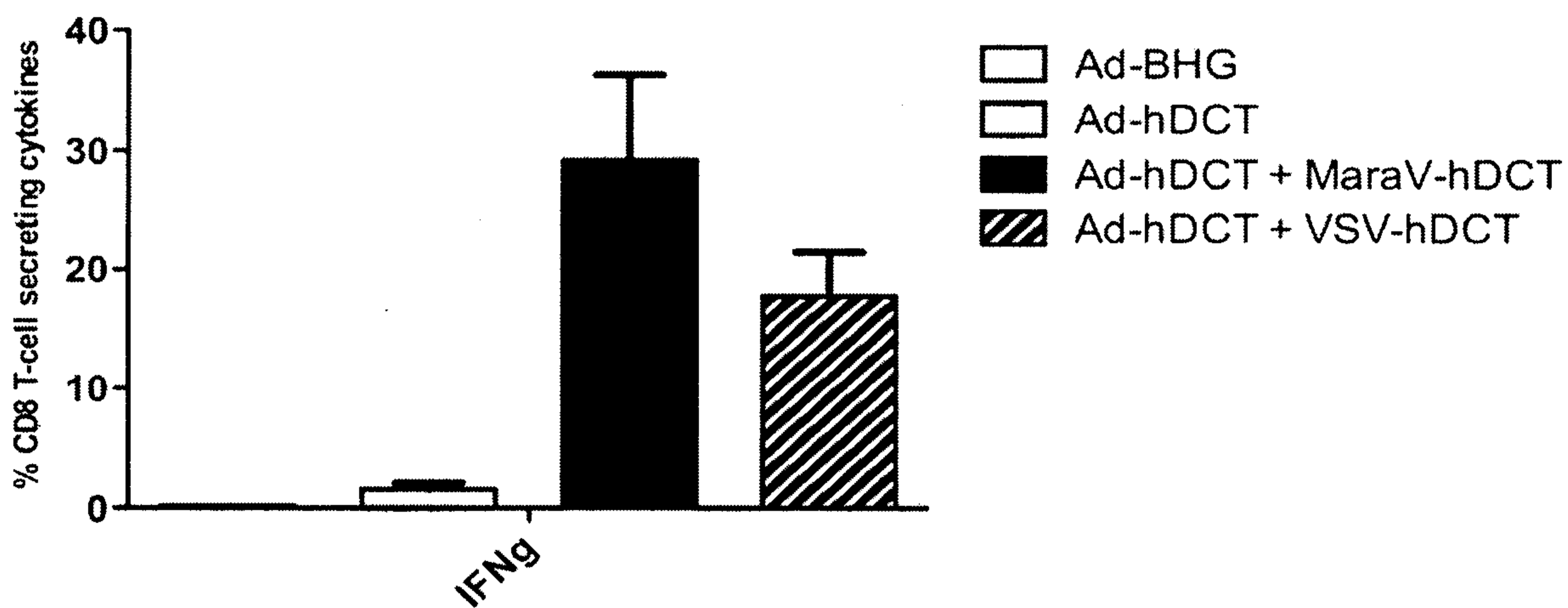
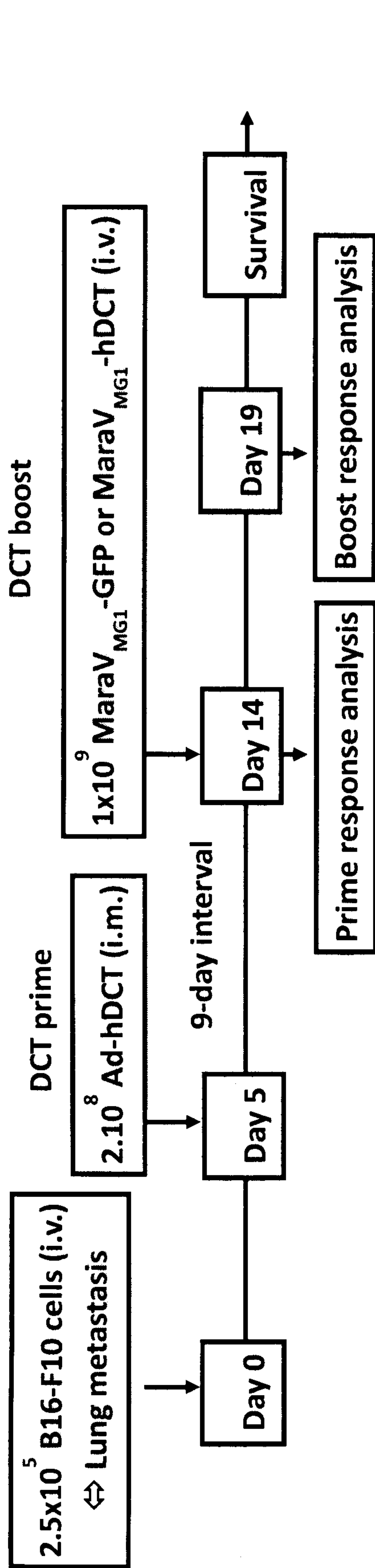
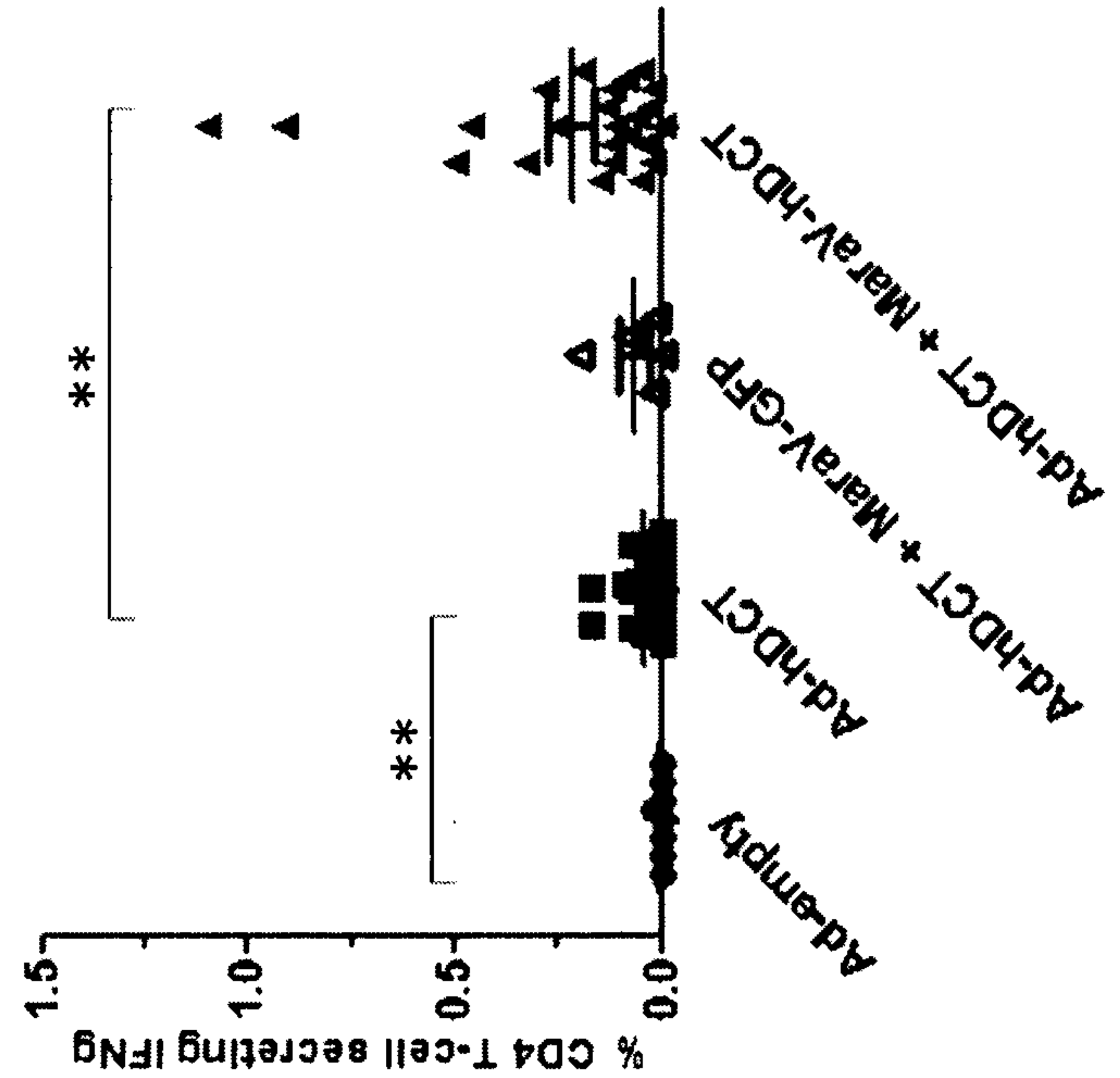

Figure 2



hDCT-specific CD4 T-cell response



hDCT-specific CD8 T-cell response

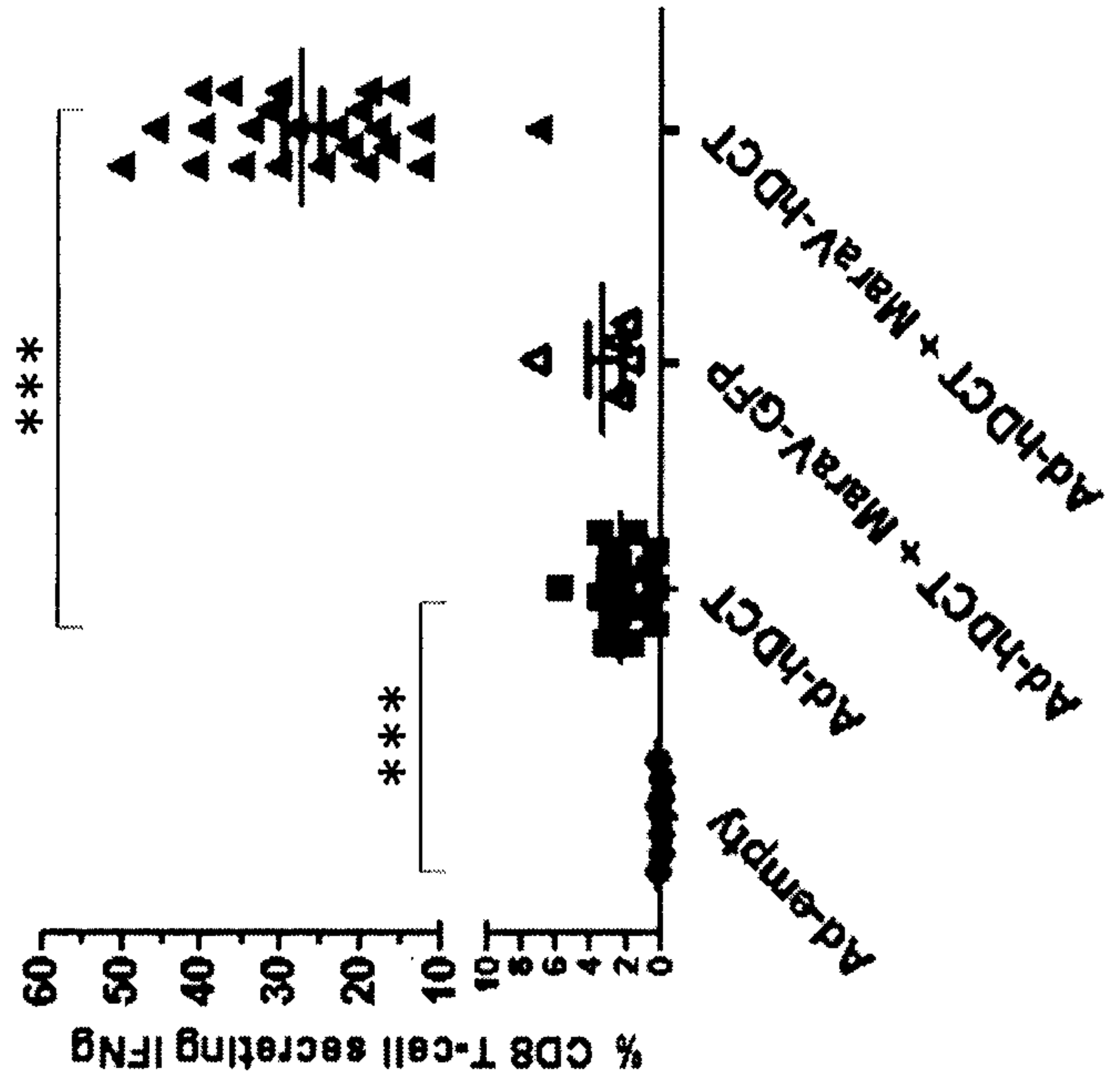

Figure 3

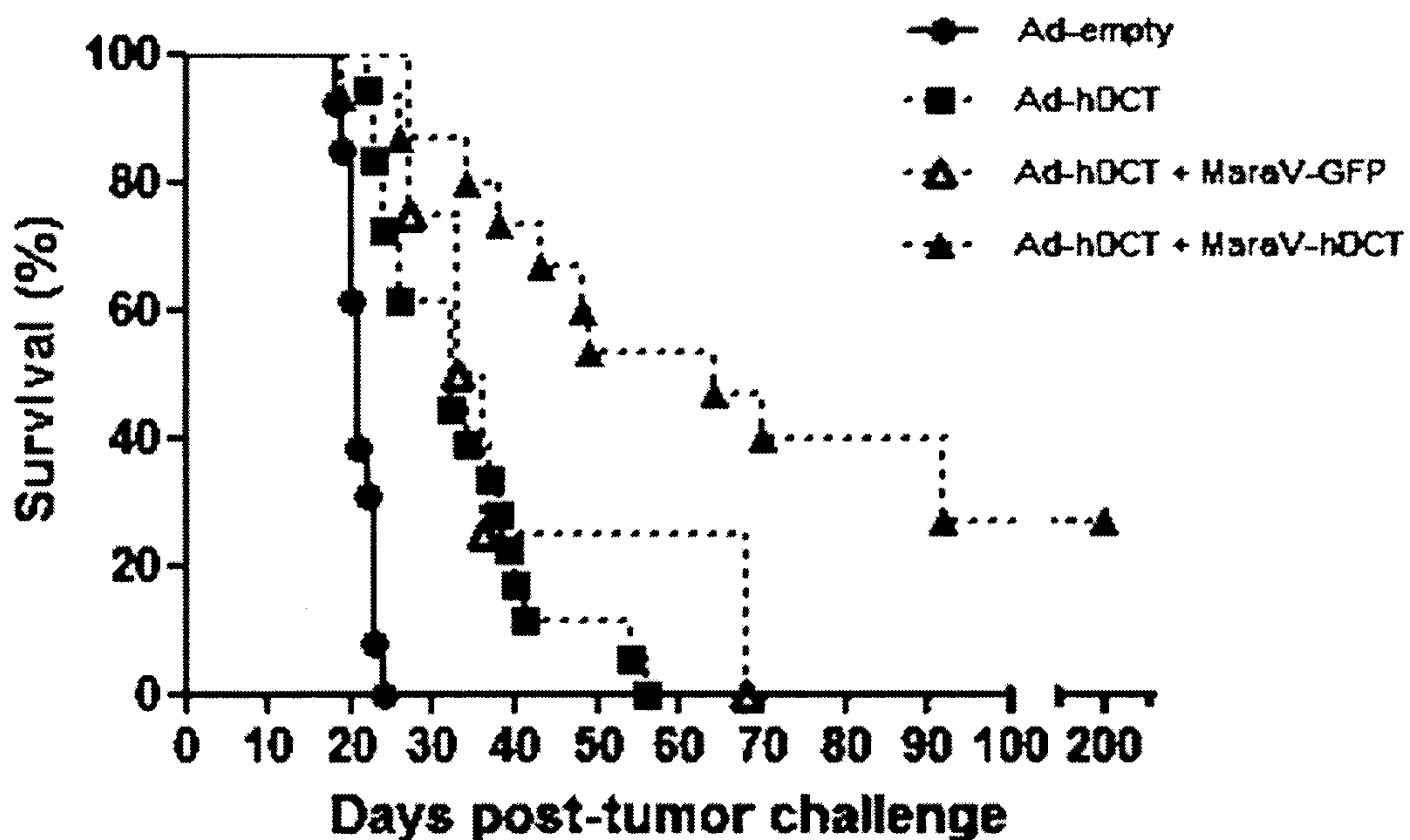

Figure 4

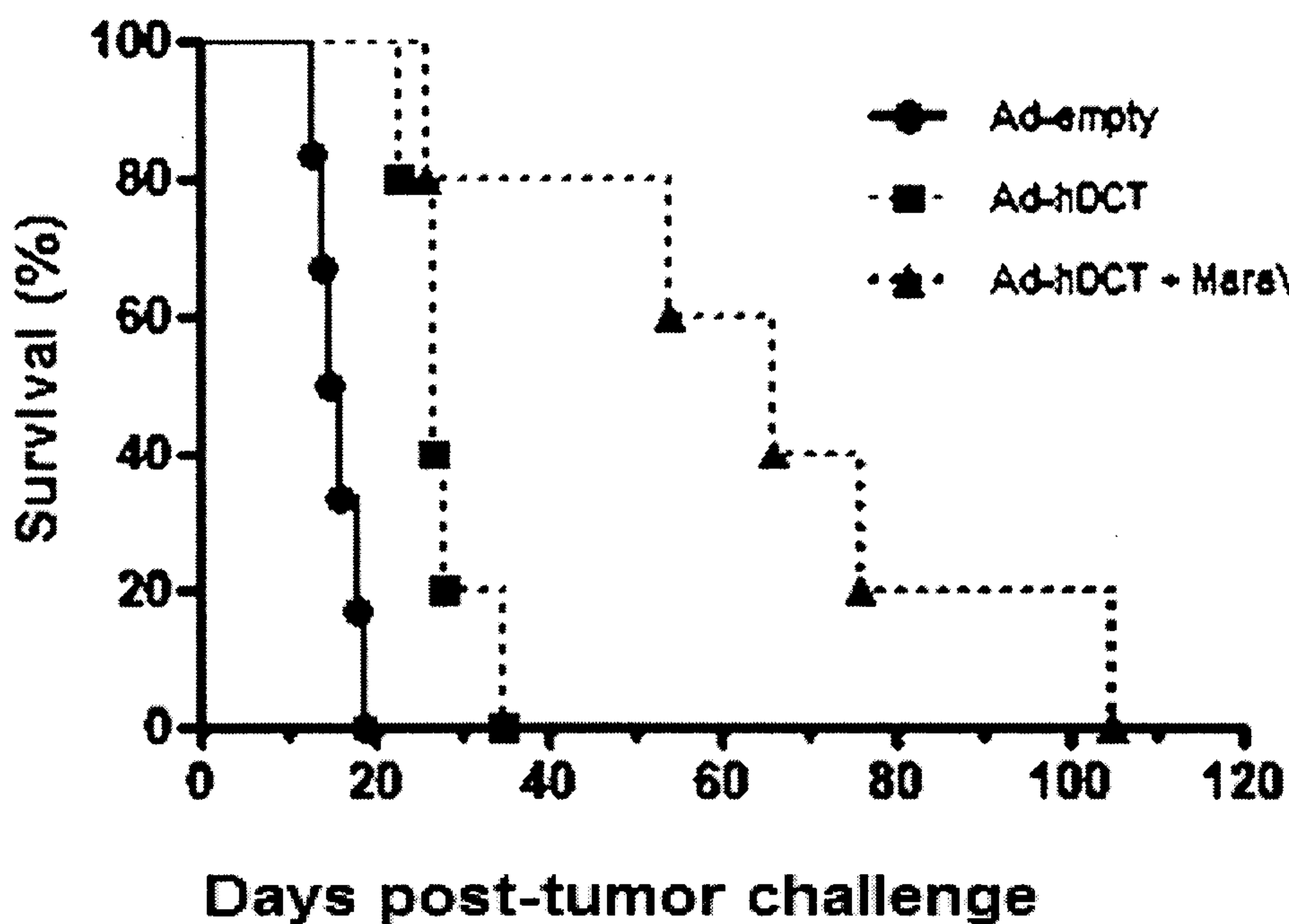
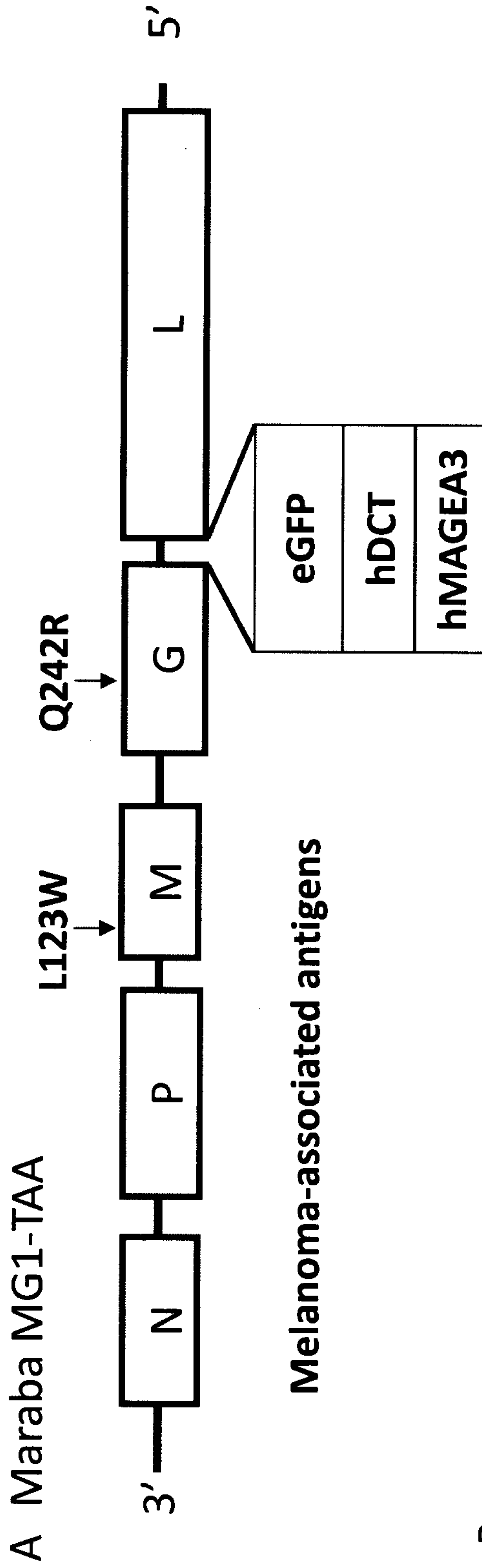

Figure 5



B

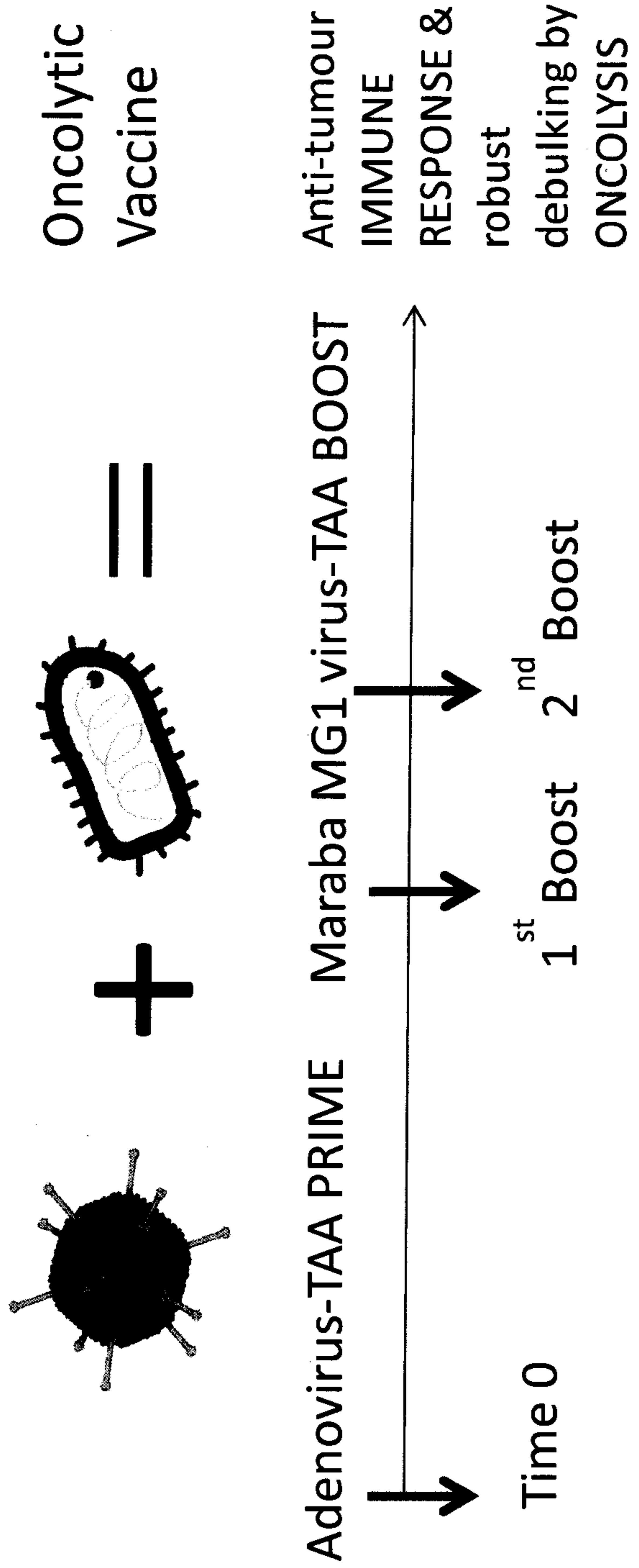

Figure 6

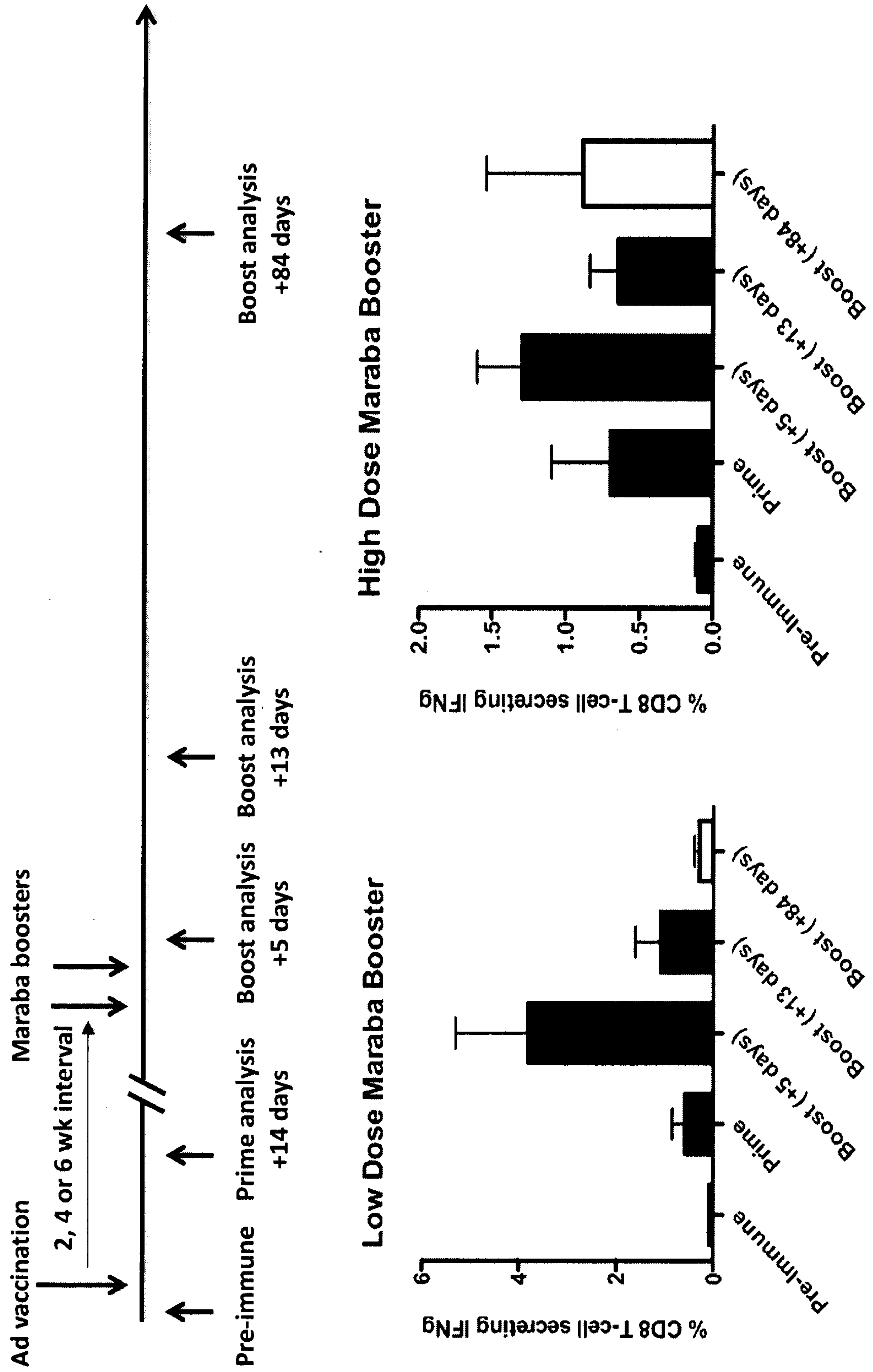

Figure 7

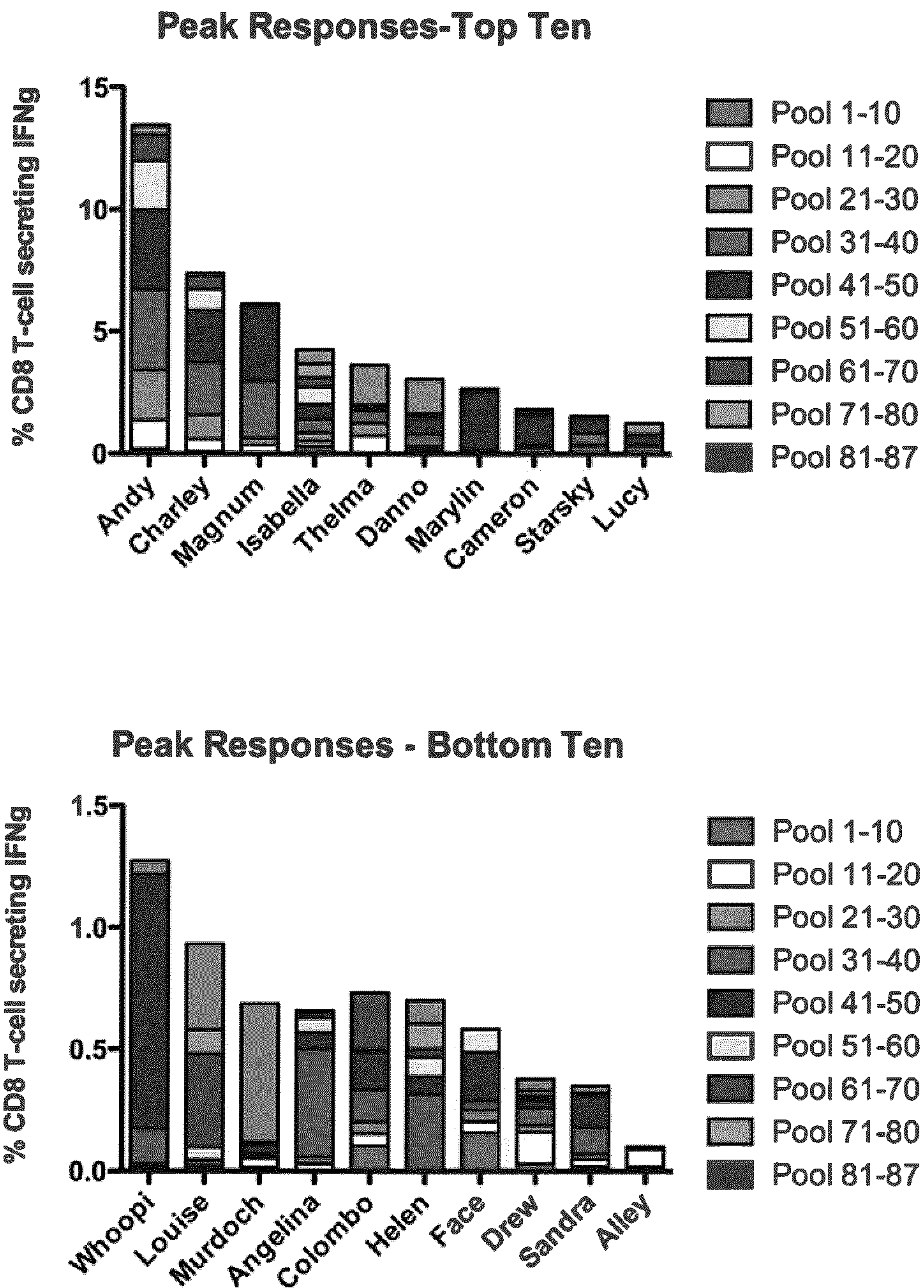
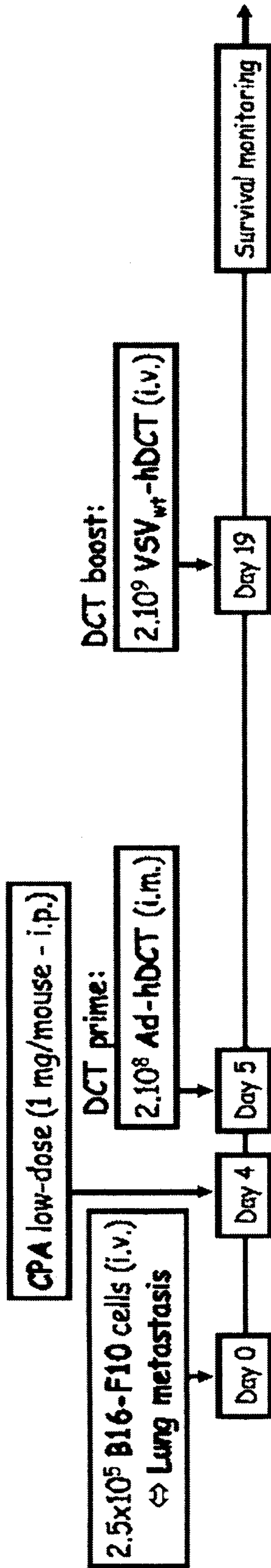

Figure 8



Survival: B16F10 Lung mets model

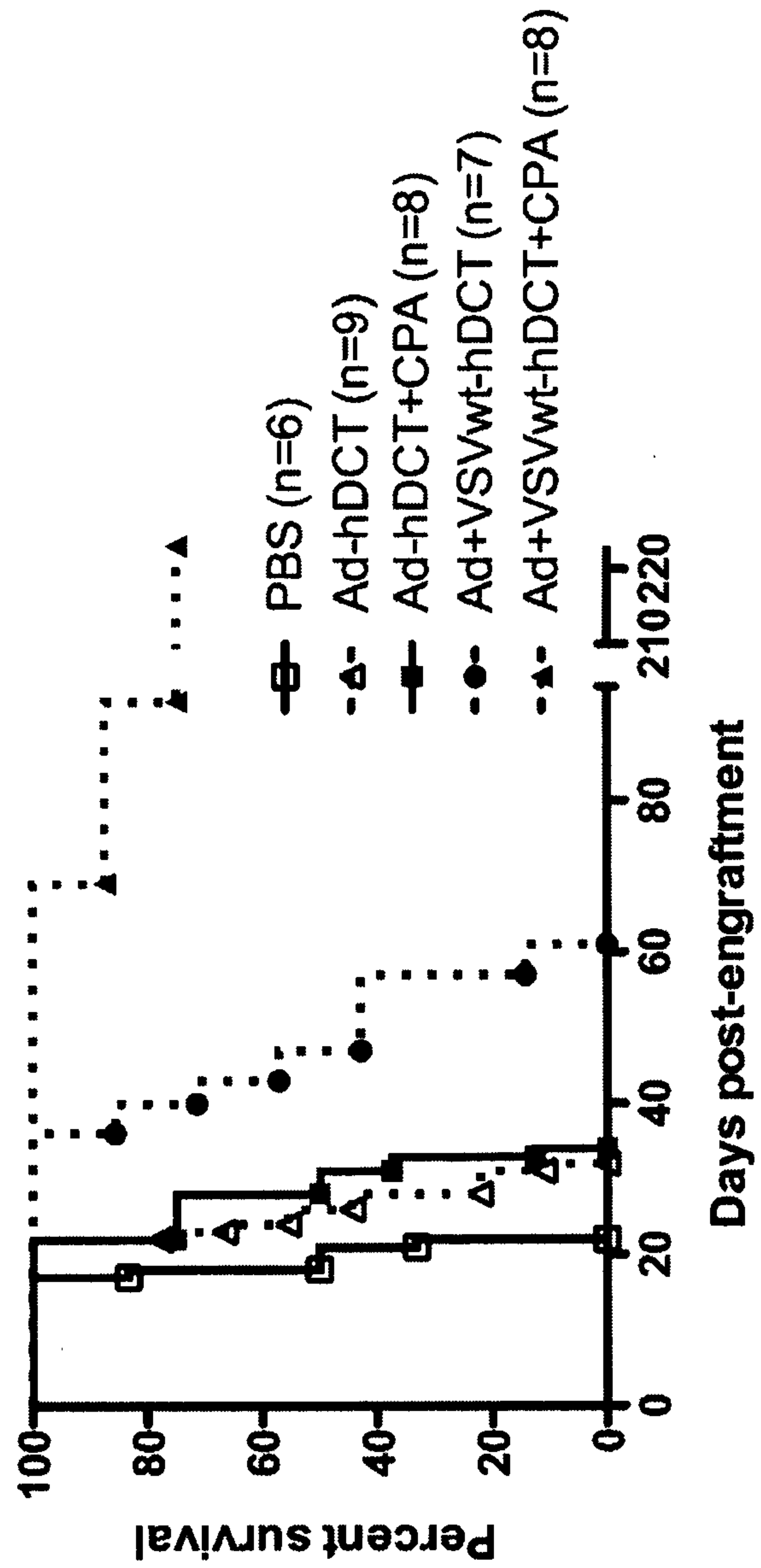

Figure 9

DCT(SVY)

Figure 1A

DCT(hKFF)

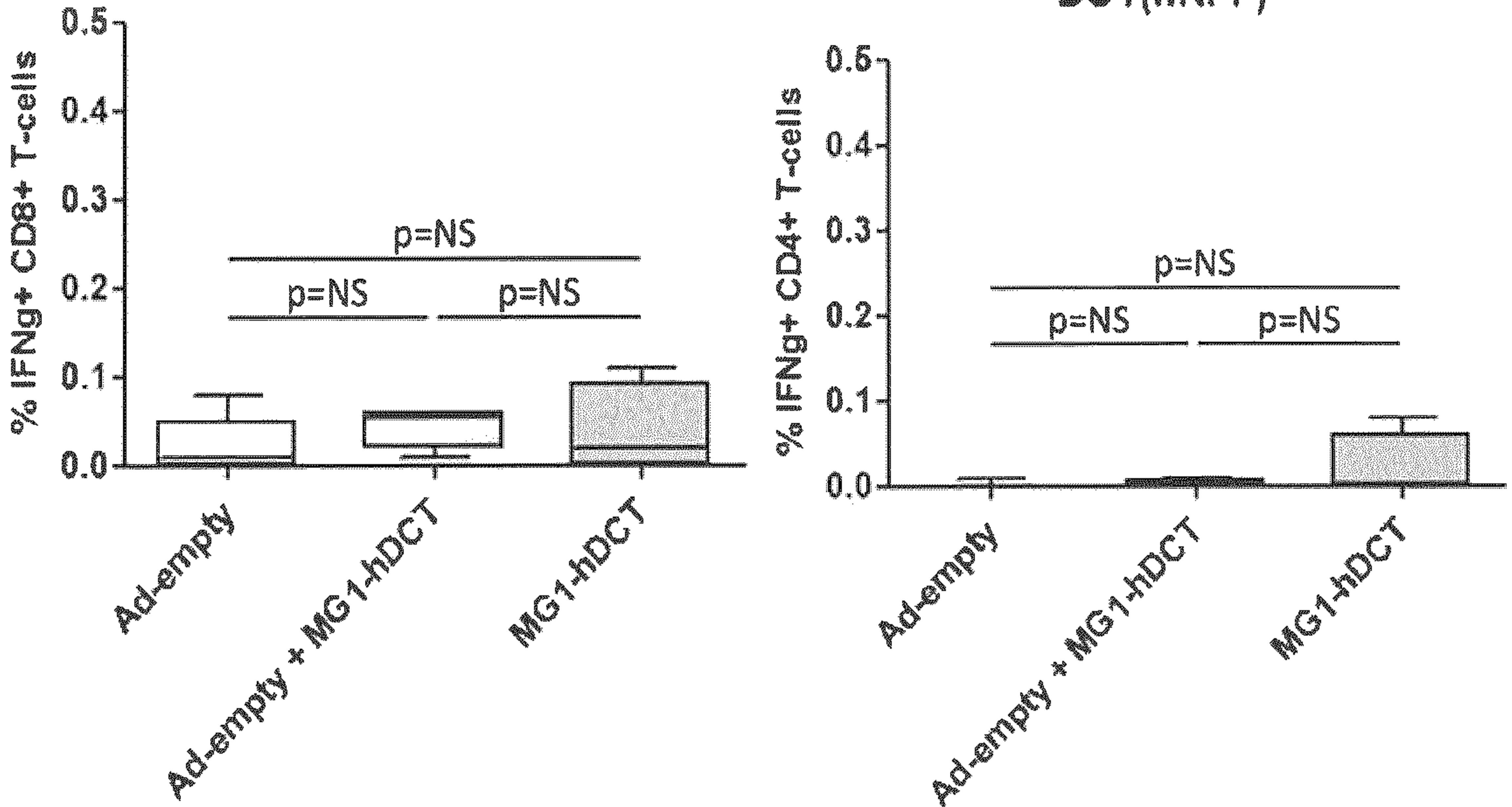

Figure 1B

Lung tumor

