

[54] CAMERA

[75] Inventors: Nobuo Kikuchi, Tokyo; Akio Sunouchi; Toyokazu Mizogui, both of Kawasaki, all of Japan

[73] Assignee: Canon Kabushiki Kaisha, Tokyo, Japan

[**] Term: 14 Years

[21] Appl. No.: 872,437

[22] Filed: Jun. 9, 1986

[30] Foreign Application Priority Data

Dec. 13, 1985 [JP] Japan 60-52095

[52] U.S. Cl. D16/1; D16/8

[58] Field of Search D16/1-10; 354/83.86, 149.11, 152, 173.1, 173.11, 204, 212, 288 A-288 F, 288 M, 288 P, 288 U

[56] References Cited

U.S. PATENT DOCUMENTS

- D. 283,713 5/1986 Maitani D16/8
- D. 284,287 6/1986 Kato D16/8
- D. 284,384 6/1986 Kato D16/8

OTHER PUBLICATIONS

- 35 MM Photography, 1/86, p. 56, bottom—Minolta AF-T.
- Popular Photography, 4/86, p. 8, Canon T-90.
- Photography, 9/82, p. 23, top right—Plaubel 69W Pro-shift Superwide.
- 35 MM Photography, 6/85, p. 54, Canon T-80.

Primary Examiner—Bernard Ansher
Assistant Examiner—Theodore M. Shooman
Attorney, Agent, or Firm—Fitzpatrick, Cella, Harper & Scinto

[57] CLAIM

The ornamental design for a camera, as shown and described.

DESCRIPTION

FIG. 1 is a front elevational view of a camera showing our new design;
FIG. 2 is a rear elevational view thereof;
FIG. 3 is a top plan view thereof;
FIG. 4 is a bottom plan view thereof;
FIG. 5 is a left side elevational view thereof;
FIG. 6 is a right side elevational view thereof; and
FIG. 7 is a top, front and left side perspective view thereof.

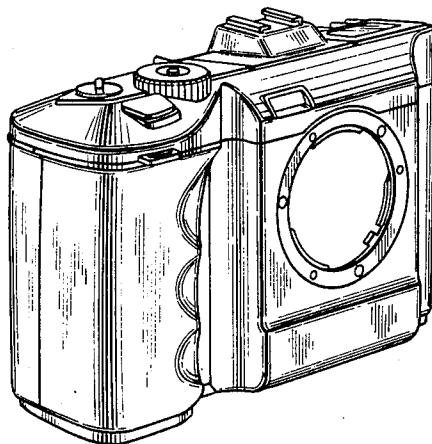

FIG. 1

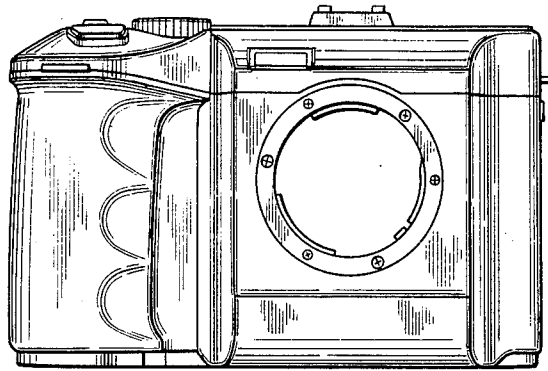

FIG. 2

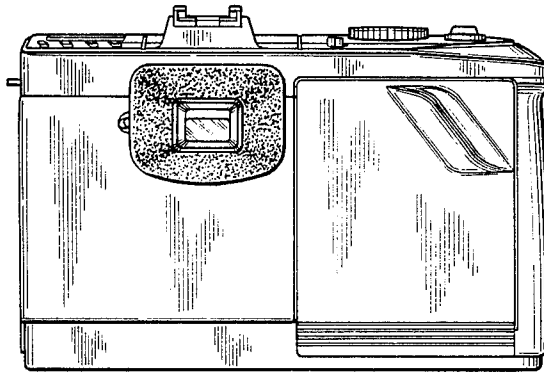

FIG. 3

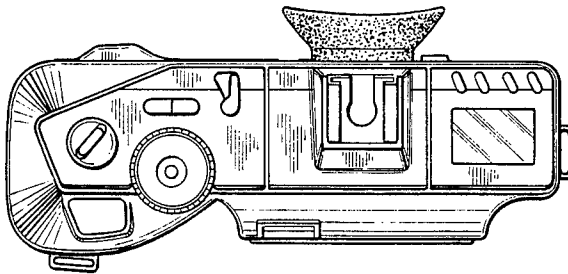

FIG. 4

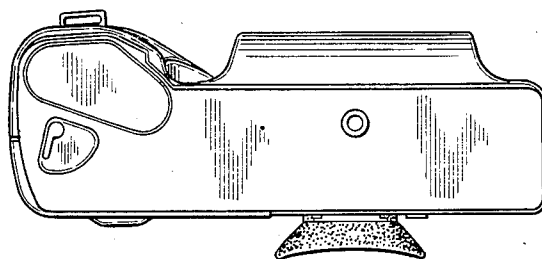

FIG. 5

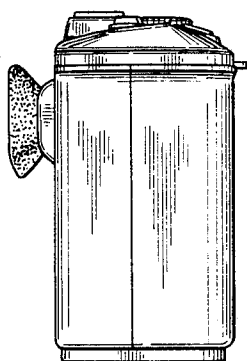

FIG. 6

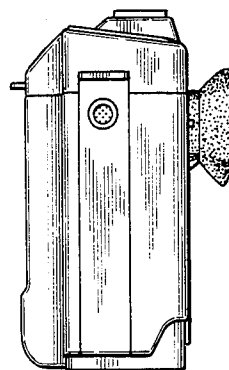

FIG. 7

