



US00D588826S

(12) **United States Design Patent**
Ricchio

(10) **Patent No.:** **US D588,826 S**

(45) **Date of Patent:** **** Mar. 24, 2009**

(54) **CHAIR**

(75) Inventor: **Joseph D. Ricchio**, Seal Beach, CA (US)

(73) Assignee: **Michigan Tube Swagers & Fabricators, Inc.**, Temperature, MI (US)

(**) Term: **14 Years**

(21) Appl. No.: **29/307,810**

(22) Filed: **May 14, 2008**

(51) **LOC (9) Cl.** **06-01**

(52) **U.S. Cl.** **D6/380; D6/360**

(58) **Field of Classification Search** D6/334-336,
D6/349, 360, 370, 371, 372, 373, 374, 375,
D6/376, 379, 380, 500-502; 297/445.1,
297/446.1, 448.1, 452.29, 452.63

See application file for complete search history.

(56) **References Cited**

U.S. PATENT DOCUMENTS

D180,660 S *	7/1957	Johnson	D6/373
D272,018 S *	1/1984	Thompson	D6/380
D357,592 S *	4/1995	Kellen	D6/360
D396,563 S	8/1998	Meijer et al.	
D460,282 S	7/2002	Starck et al.	
D475,212 S	6/2003	Savini et al.	
D494,771 S	8/2004	de Blois	
D528,813 S *	9/2006	Sienkowski et al.	D6/374
D576,817 S *	9/2008	Sienkowski	D6/374

OTHER PUBLICATIONS

Printout from Emeco website depicting Icon Chair (<http://www.emeco.net/product/iconchair.html>) (believed to have been offered for

sale, publicly used, and/or published prior to the filing date of this application.

* cited by examiner

Primary Examiner—Mimosa De

(74) *Attorney, Agent, or Firm*—Gifford, Krass, Sprinkle, Anderson & Citkowski, P.C.

(57) **CLAIM**

The ornamental design for a chair, as shown and described.

DESCRIPTION

FIG. 1 is a perspective view of a first embodiment of a chair according to the present invention;

FIG. 2 is a front-elevational view of the chair of FIG. 1;

FIG. 3 is a rear elevational view of the chair of FIGS. 1 and 2;

FIG. 4 is a side-elevational view of the chair of FIGS. 1-3, the other side view being a mirror image thereof;

FIG. 5 is a top plan view of the chair of FIGS. 1-4;

FIG. 6 is a bottom view of the chair of FIGS. 1-5;

FIG. 7 is a perspective view of a second embodiment of a chair according to the present invention;

FIG. 8 is a front-elevational view of the chair of FIG. 7;

FIG. 9 is a rear elevational view of the chair of FIGS. 7 and 8;

FIG. 10 is a side-elevational view of the chair of FIGS. 7-9, the other side view being a mirror image thereof;

FIG. 11 is a top plan view of the chair of FIGS. 7-10; and,

FIG. 12 is a bottom view of the chair of FIGS. 7-11.

1 Claim, 6 Drawing Sheets

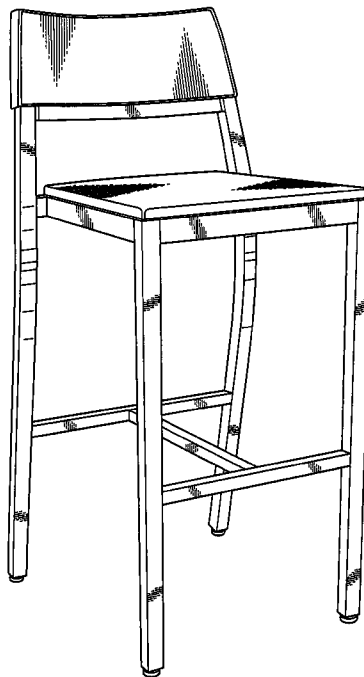
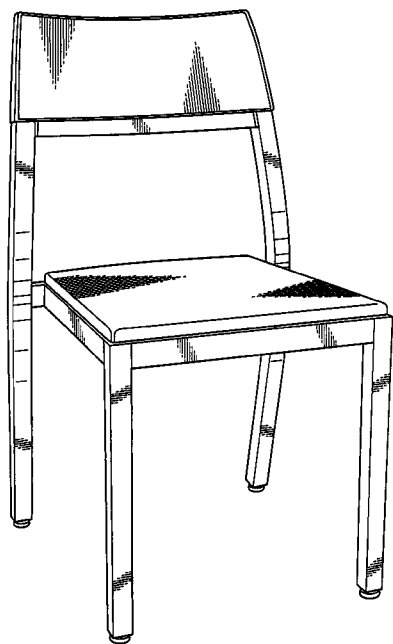
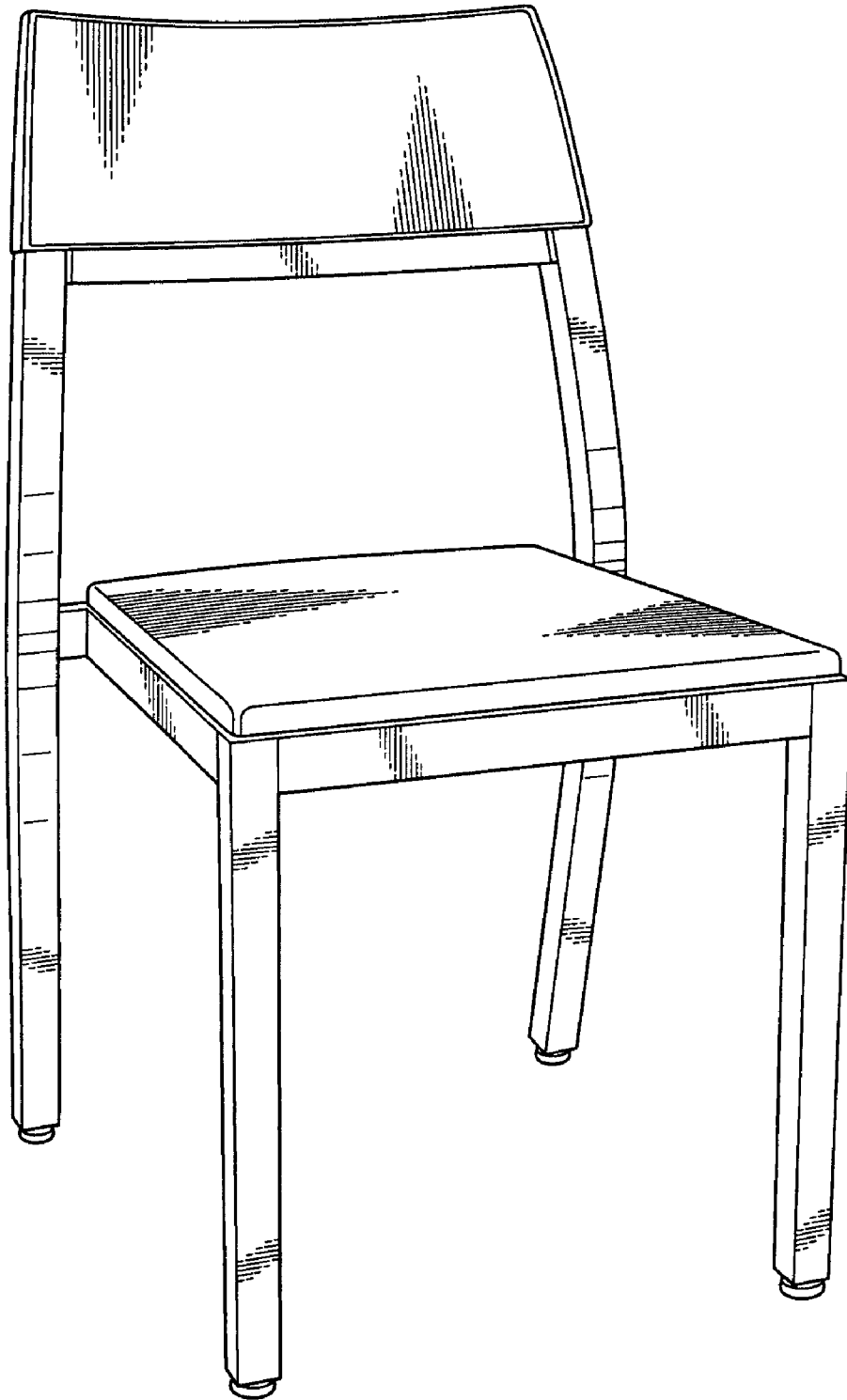

FIG - 1



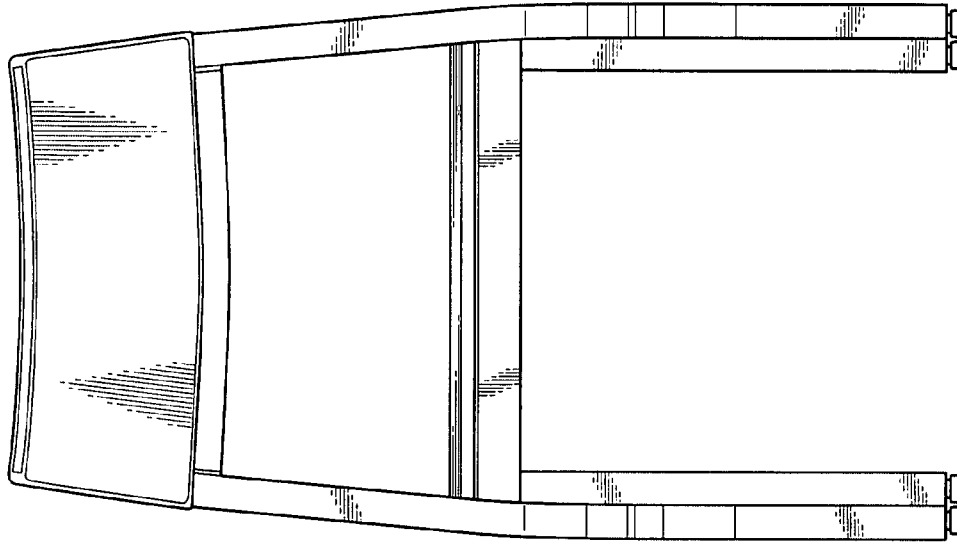

FIG - 3

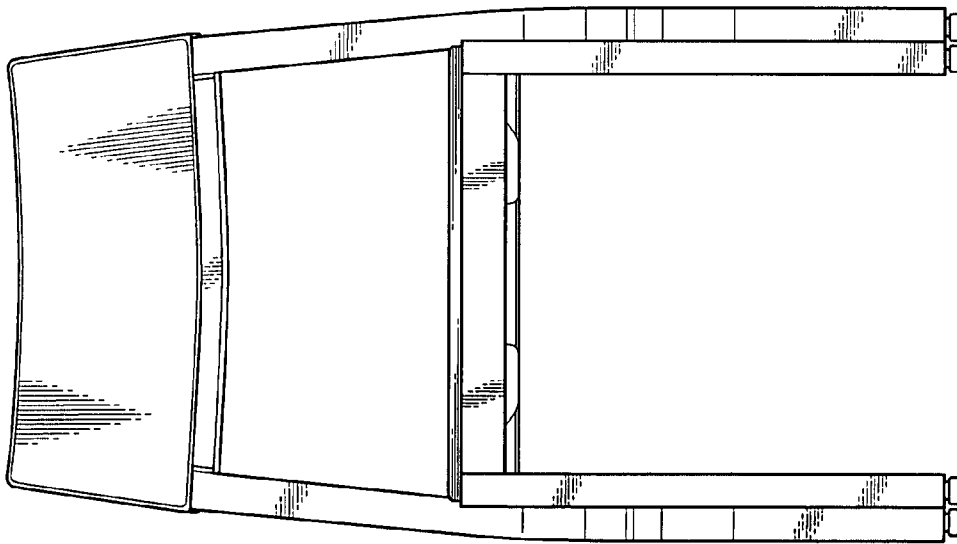

FIG - 2

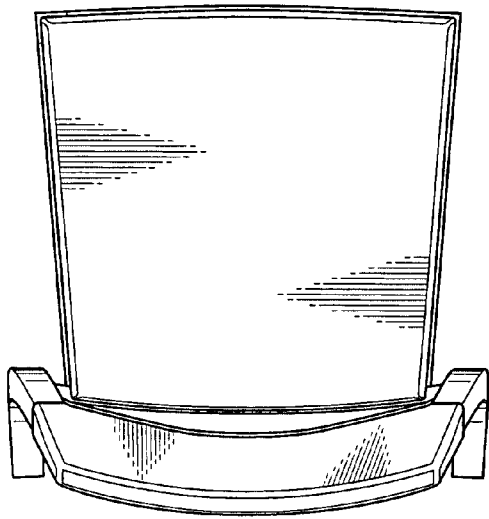

FIG - 5

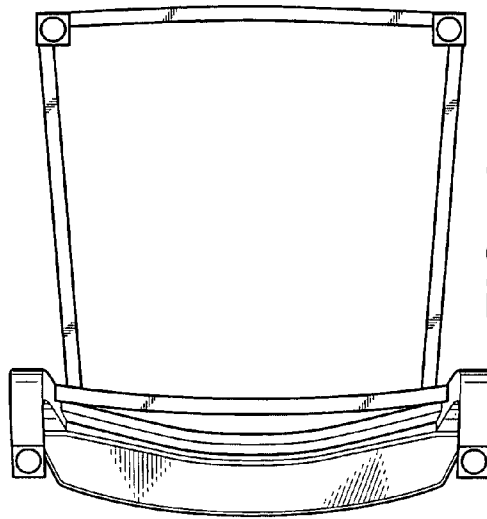

FIG - 6

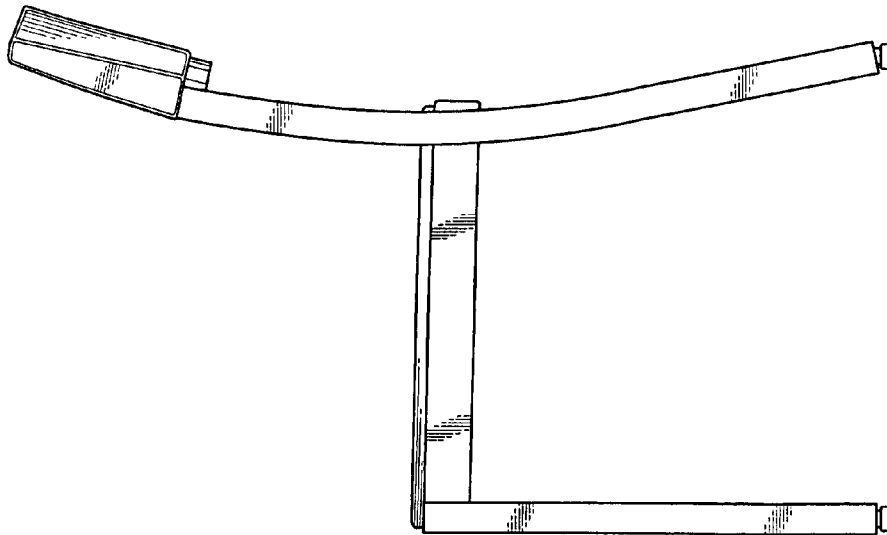
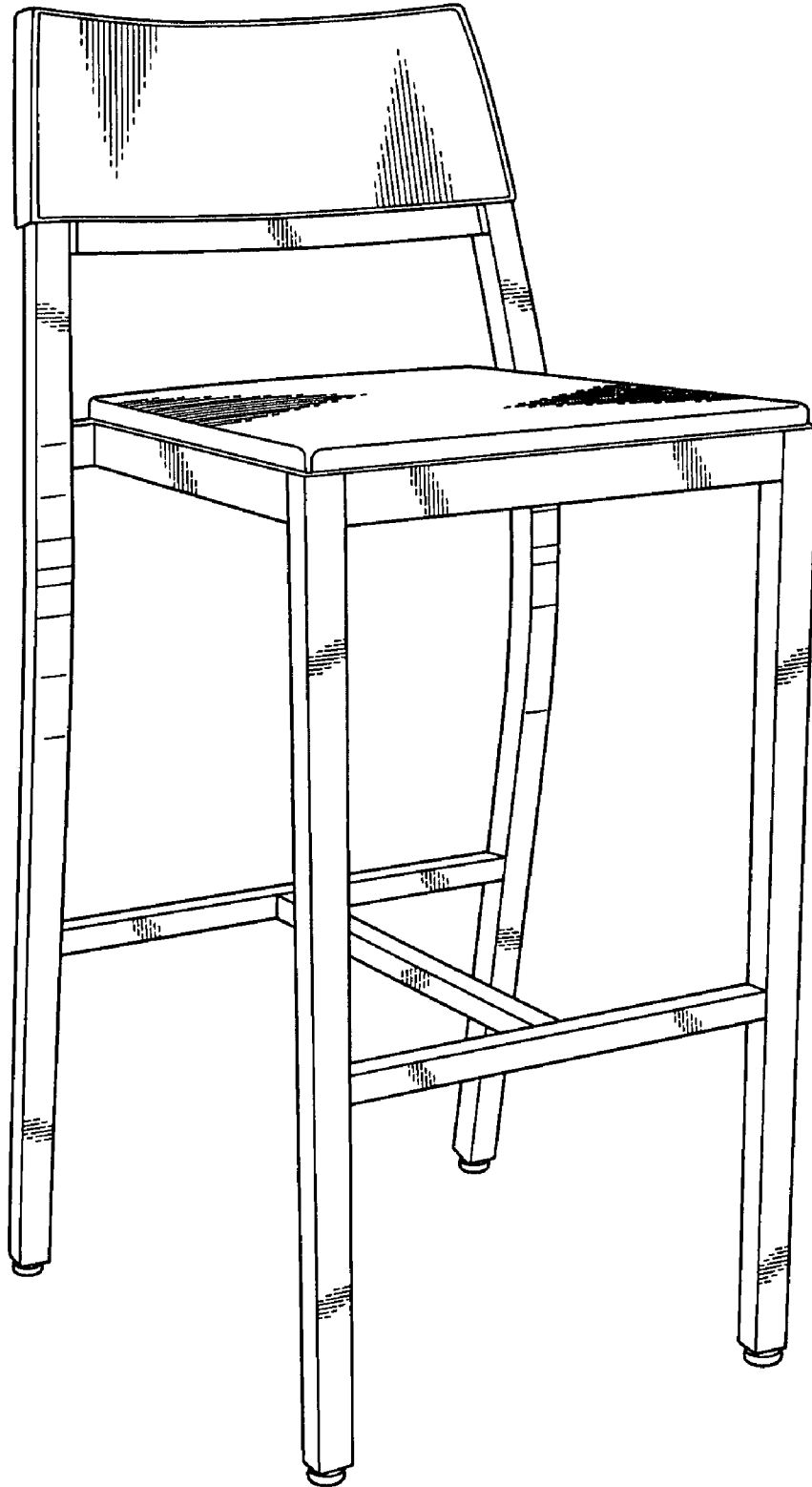

FIG - 4

FIG - 7



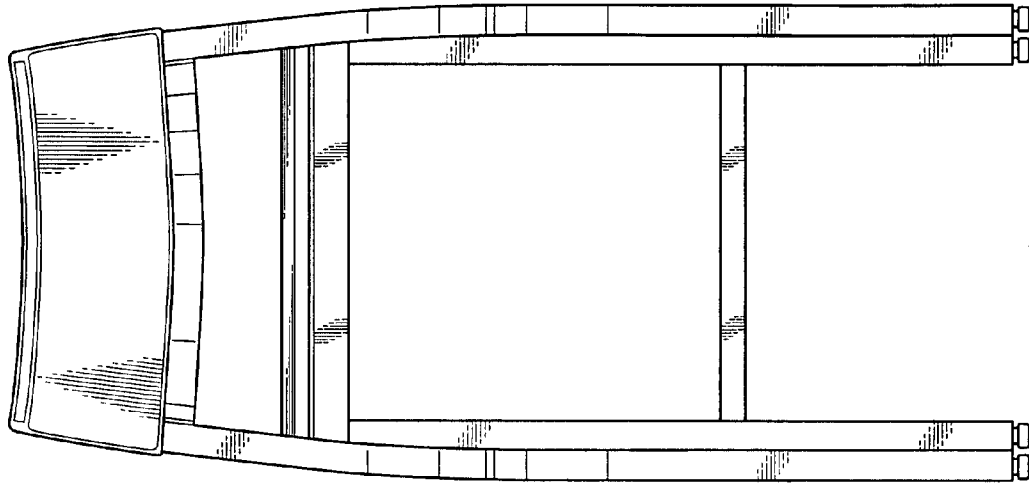

FIG - 9

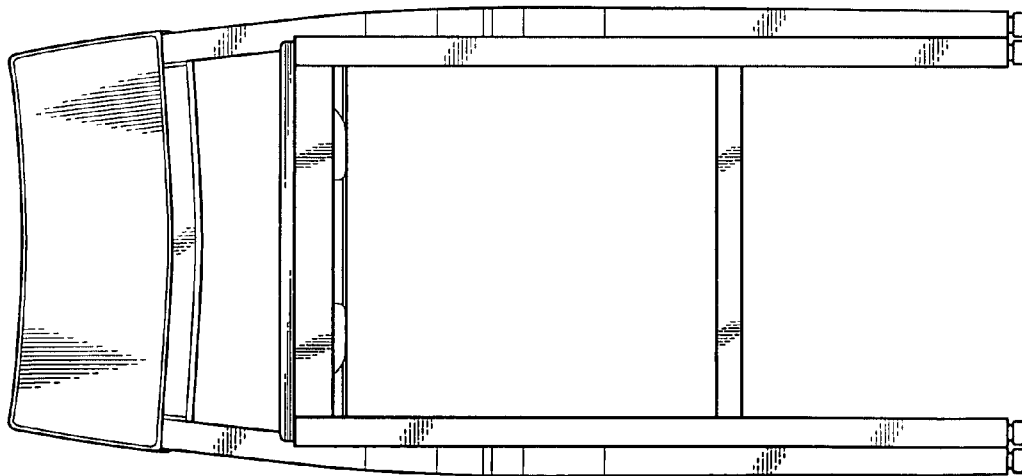

FIG - 8

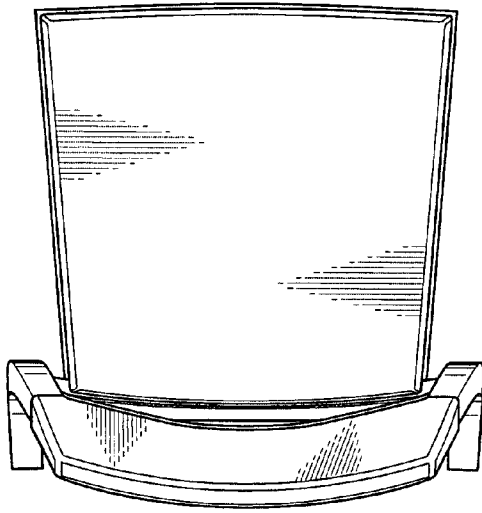

FIG - 11

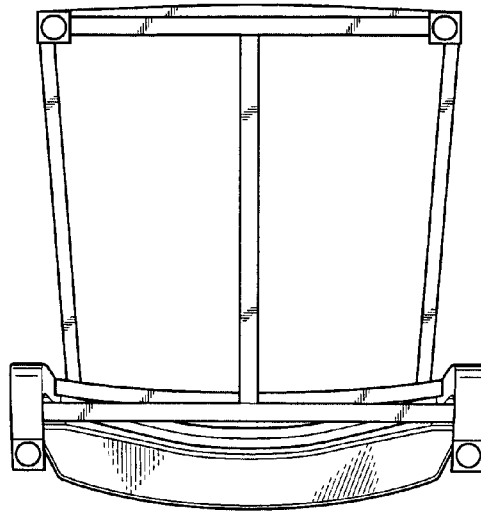

FIG - 12

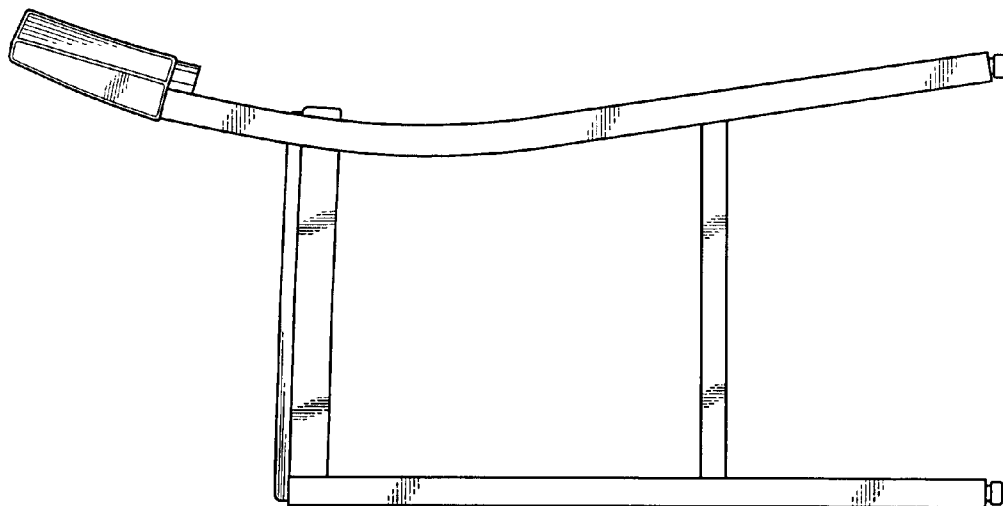

FIG - 10